

1

1.16 TP Series

TP series (TP02G-AS1, TP04G-AS2)

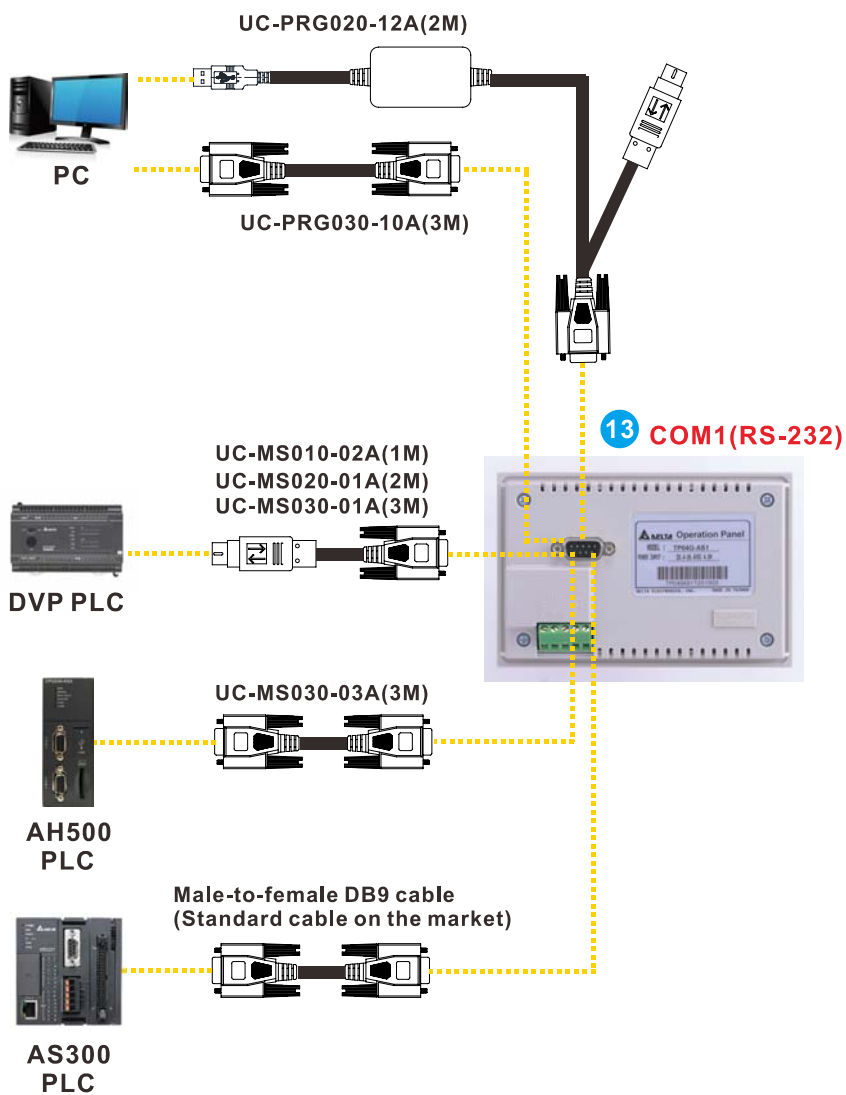

Note: Please refer to section 1.21 for more information about **1**, **2**, **3**, etc.

TP series (TP08G-BT2)

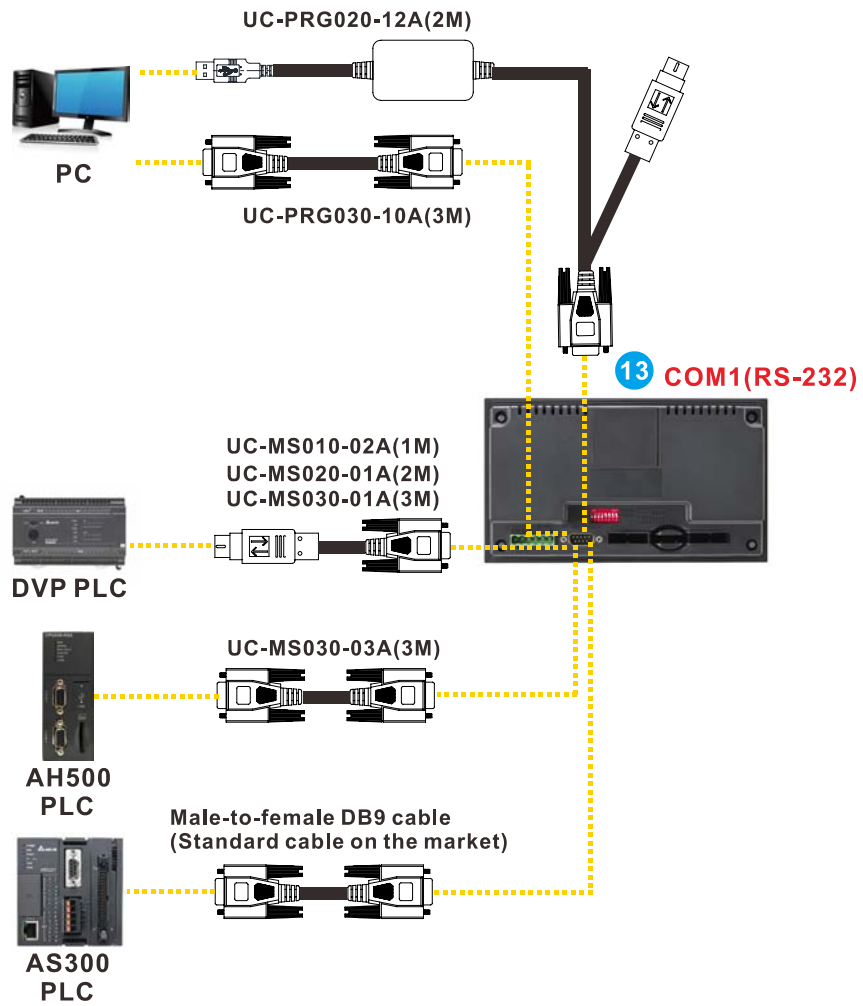

Note: Please refer to section 1.21 for more information about **1**, **2**, **3**, etc.

TP series (TP04G-AL-C, TP04G-AL2)

1

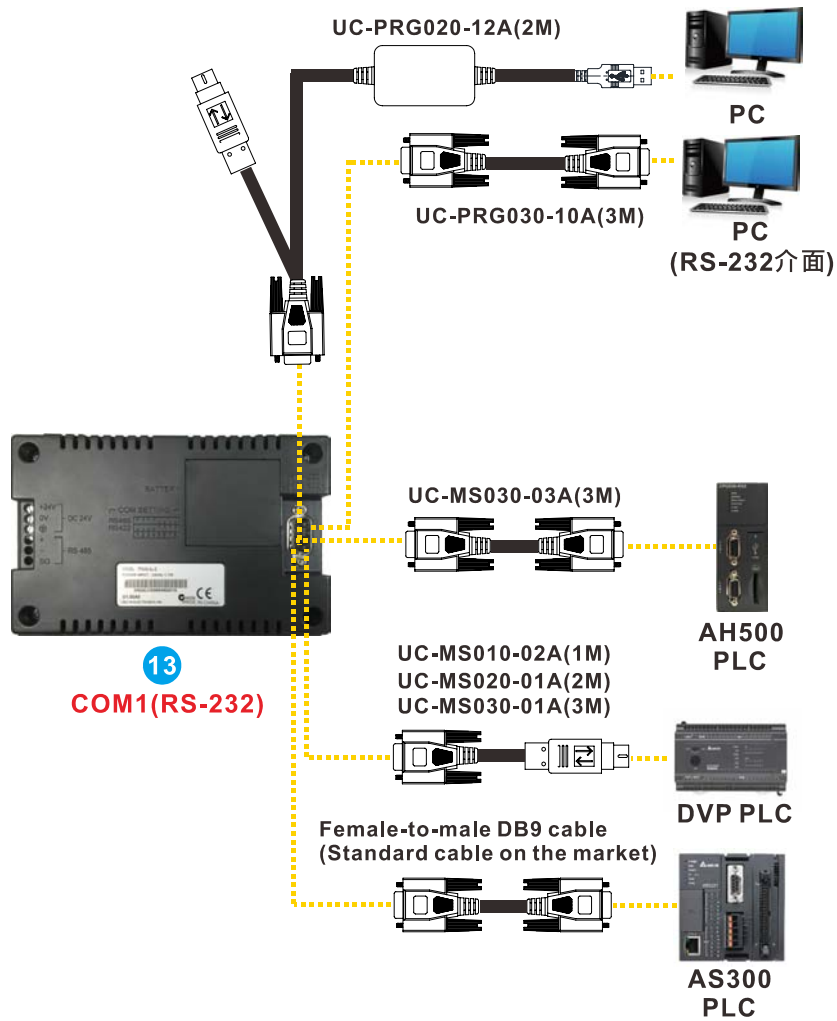

Note: Please refer to section 1.21 for more information about 1, 2, 3, etc.

TP series (TP04G-BL-C)

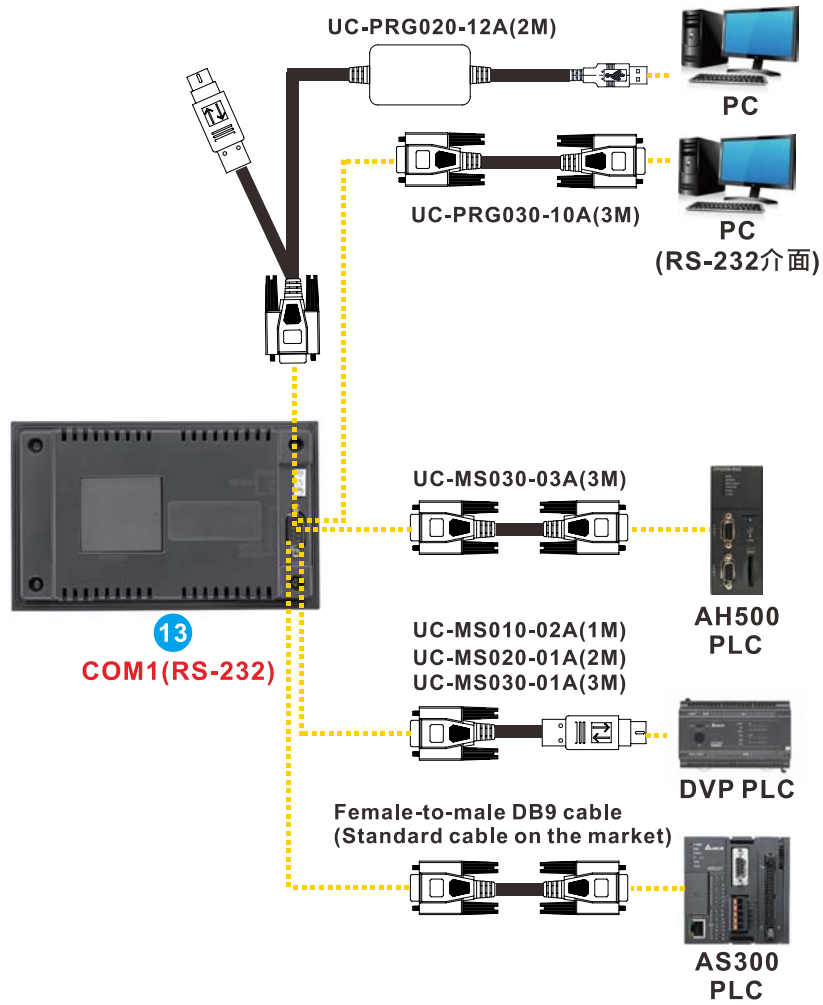

Note: Please refer to section 1.21 for more information about 1, 2, 3, etc.

TP04P series (TP04P-16TP1R, TP04P-21EX1R, TP04P-32TP1R, TP04P-22XA1R)

1

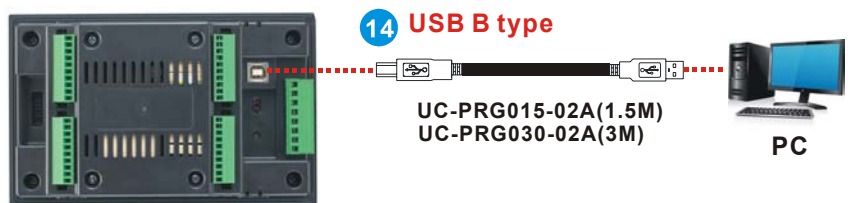

Note: Please refer to section 1.21 for more information about **1**, **2**, **3**, etc.

TP70P series (TP70P-16TP1R, TP70P-21EX1R, TP70P-22XA1R, TP70P-32TP1R)

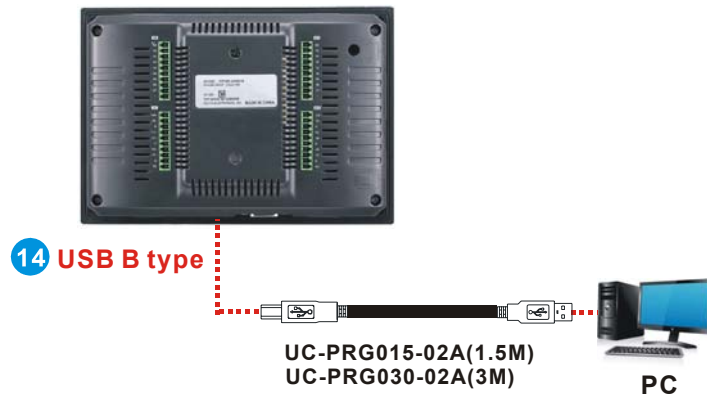

Note: Please refer to section 1.21 for more information about **1**, **2**, **3**, etc.

TP70P series (TP70P-RM0, TP70P-RM1, TP70P-RM2)

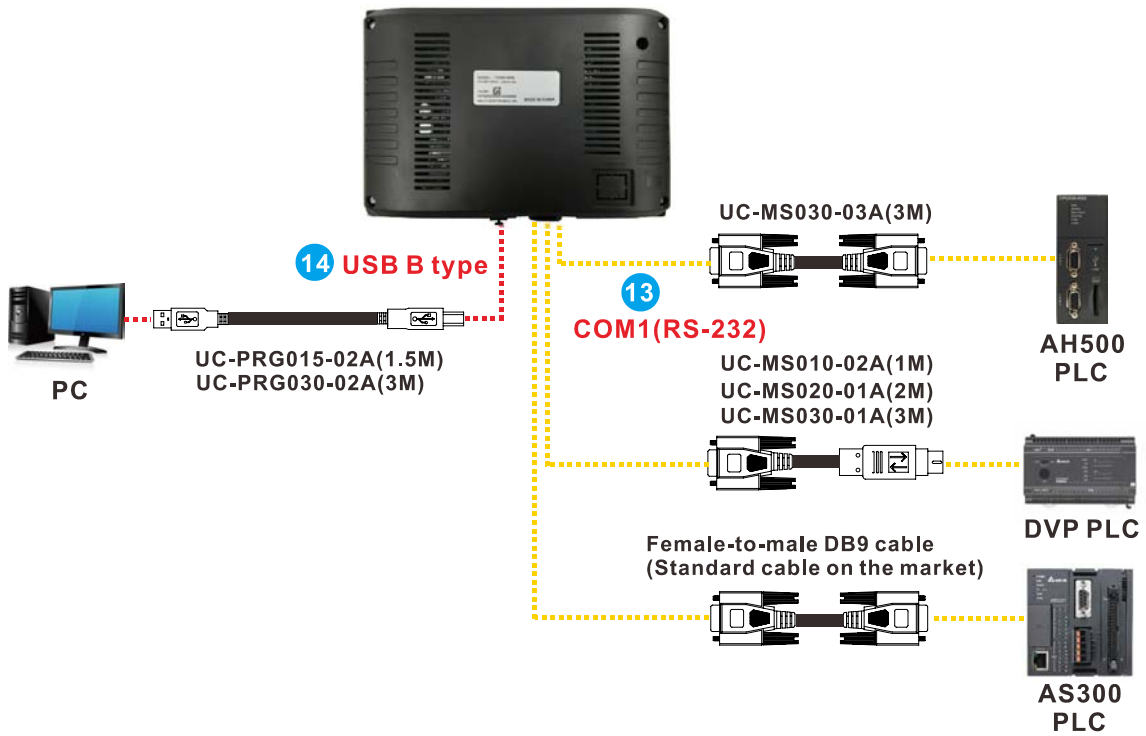

Note: Please refer to section 1.21 for more information about **1**, **2**, **3**, etc.

1.17 DOP-B Series

DOP-B series (DOP-B03E211)

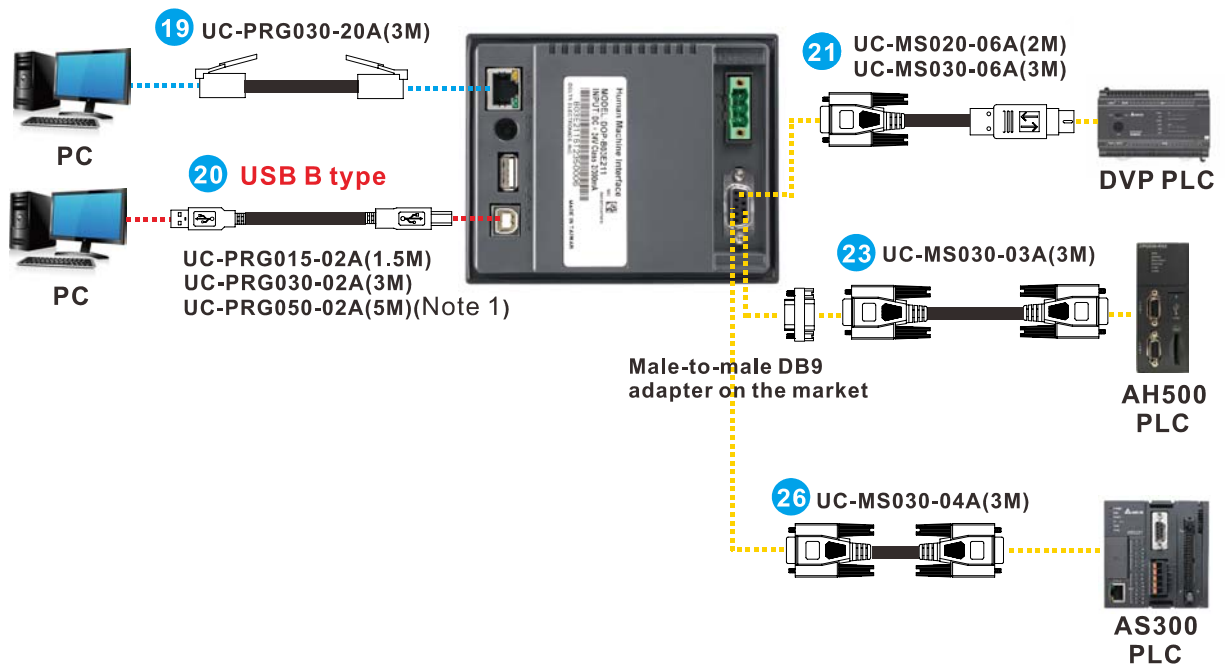

Note1: UC-PRG050-02A is used for transferring input signals between the interface panel and the controller. The cable is used exclusively for all-electric injection molding machines.

Note2: Please refer to section 1.21 for more information about **1**, **2**, **3**, etc.

DOP-B series (DOP-B03S210, DOP-B03S211)

1

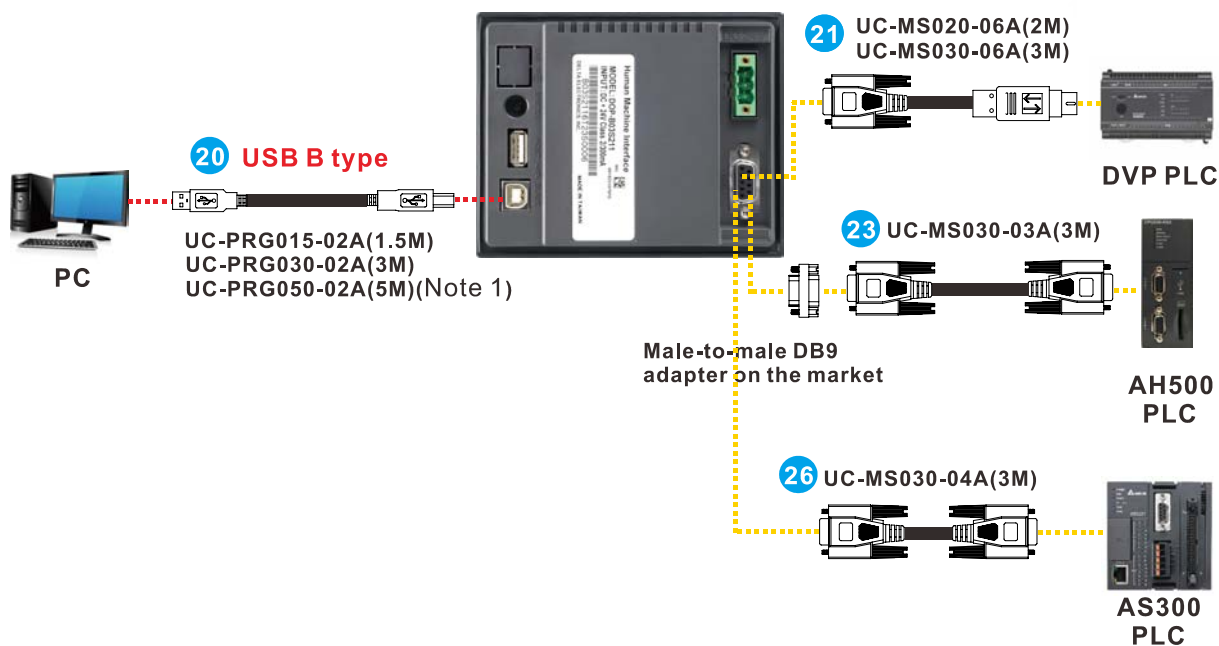

Note1: UC-PRG050-02A is used for transferring input signals between the interface panel and the controller. The cable is used exclusively for all-electric injection molding machines.

Note2: Please refer to section 1.21 for more information about **1**, **2**, **3**, etc.

DOP-B series (DOP-B05S111)

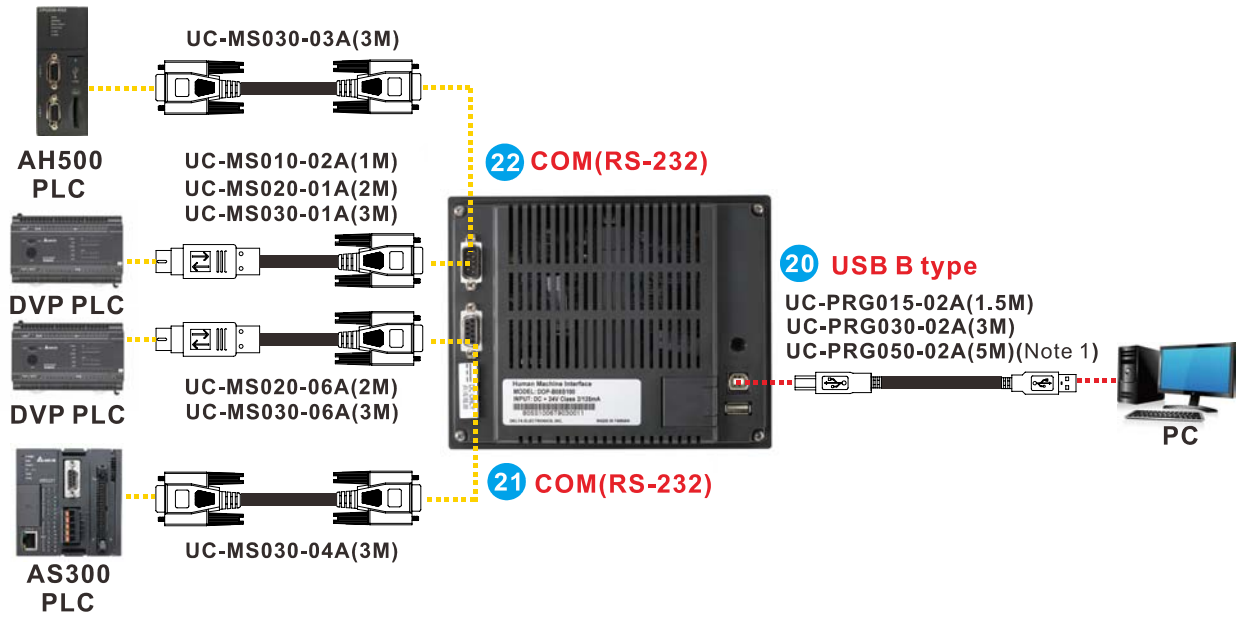

Note1: UC-PRG050-02A is used for transferring input signals between the interface panel and the controller. The cable is used exclusively for all-electric injection molding machines.

Note2: Please refer to section 1.21 for more information about 1, 2, 3, etc.

DOP-B series (DOP-B07S410)

1

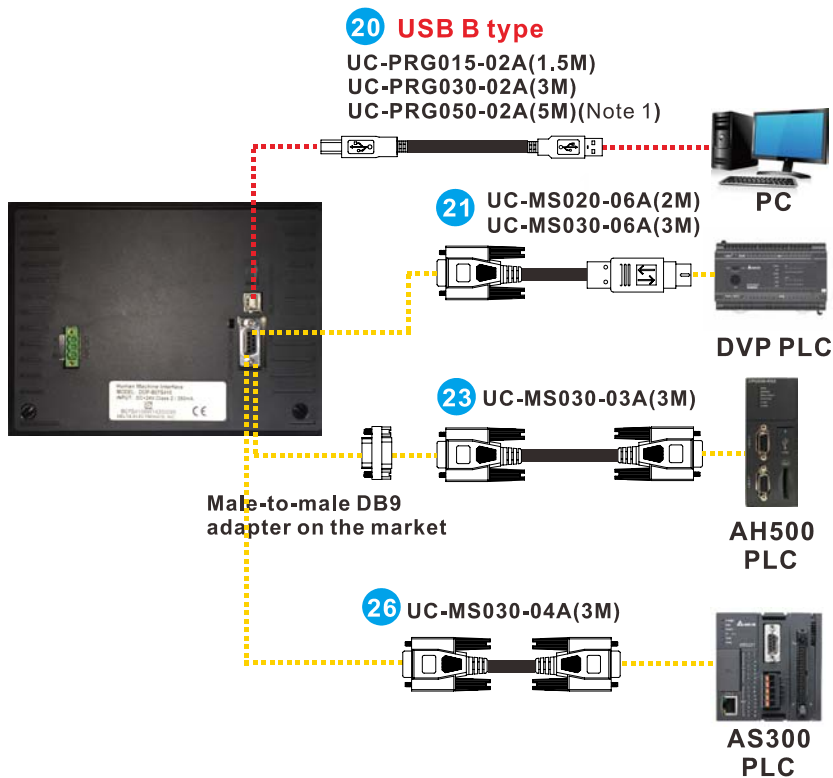

Note1 : UC-PRG050-02A is used for transferring input signals between the interface panel and the controller. The cable is used exclusively for all-electric injection molding machines.

Note2: Please refer to section 1.21 for more information about **1**, **2**, **3**, etc.

DOP-B series (DOP-B07S411, DOP-B07S401K, DOP-B07S411K, DOP-B07S415, DOP-B07PS415)

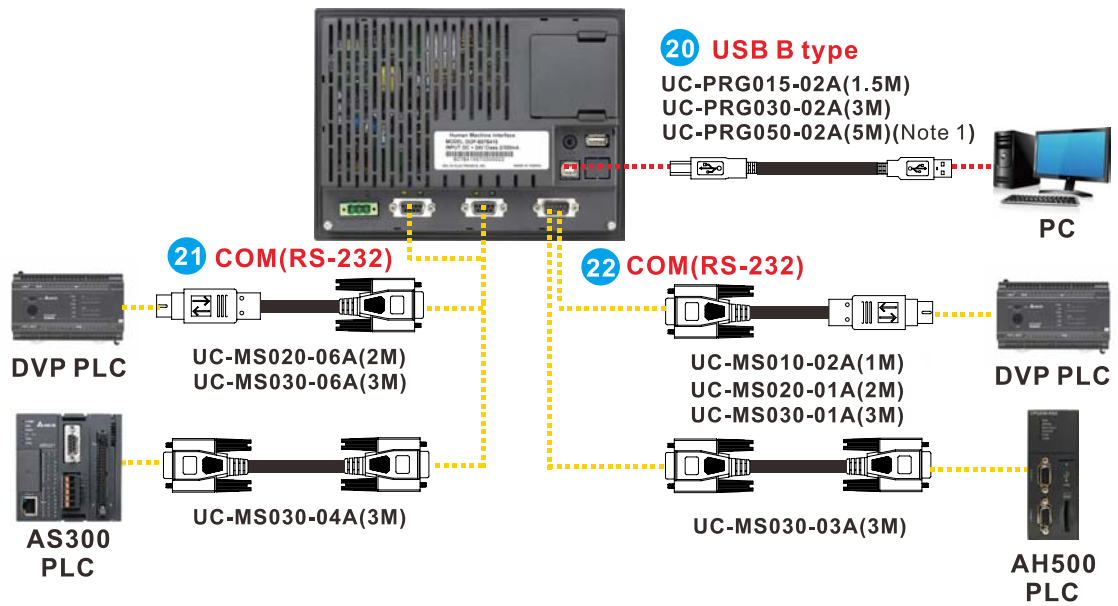

Note1: UC-PRG050-02A is used for transferring input signals between the interface panel and the controller. The cable is used exclusively for all-electric injection molding machines.

Note2: Please refer to section 1.21 for more information about 1, 2, 3, etc.

DOP-B series (DOP-B07E415)

1

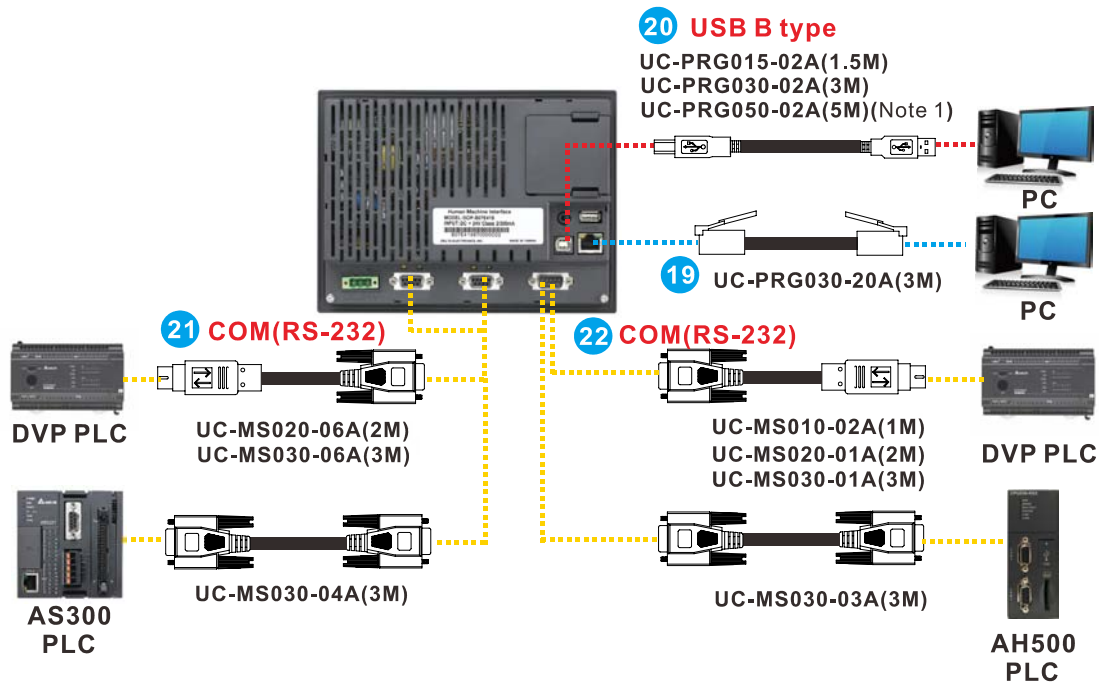

Note1 : UC-PRG050-02A is used for transferring input signals between the interface panel and the controller. The cable is used exclusively for all-electric injection molding machines.

Note2: Please refer to section 1.21 for more information about **1**, **2**, **3**, etc.

DOP-B series (DOP-B07S515, DOP-B07PS515)

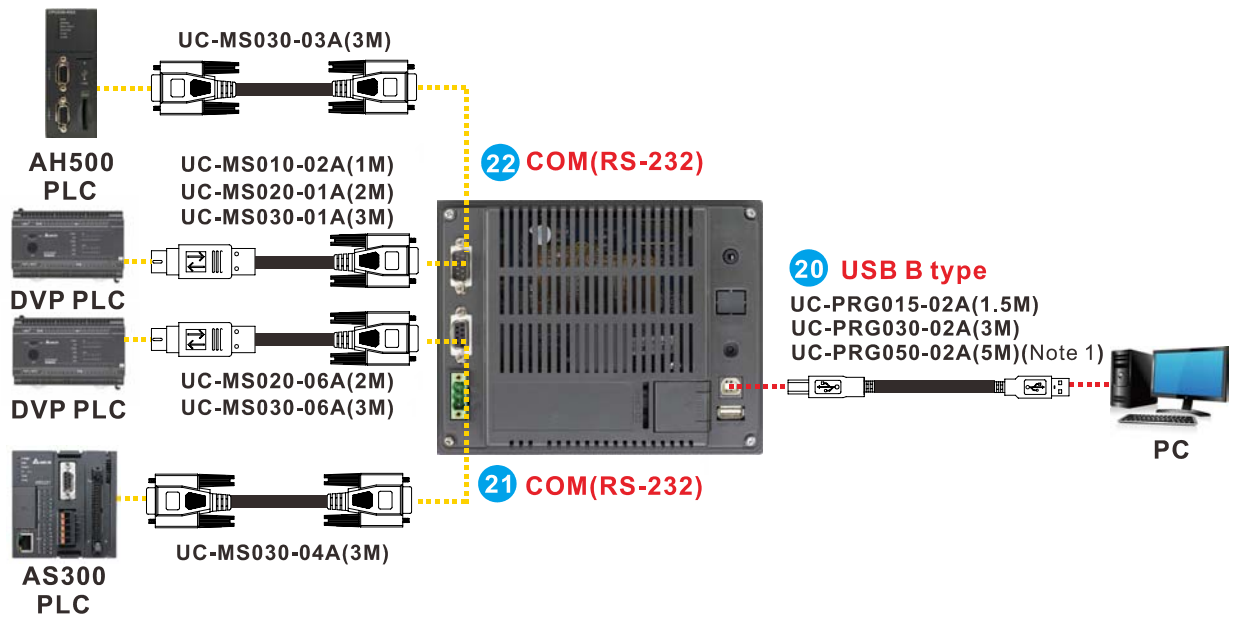

Note1: UC-PRG050-02A is used for transferring input signals between the interface panel and the controller. The cable is used exclusively for all-electric injection molding machines.

Note2: Please refer to section 1.21 for more information about 1, 2, 3, etc.

DOP-B series (DOP-B07E515)

1

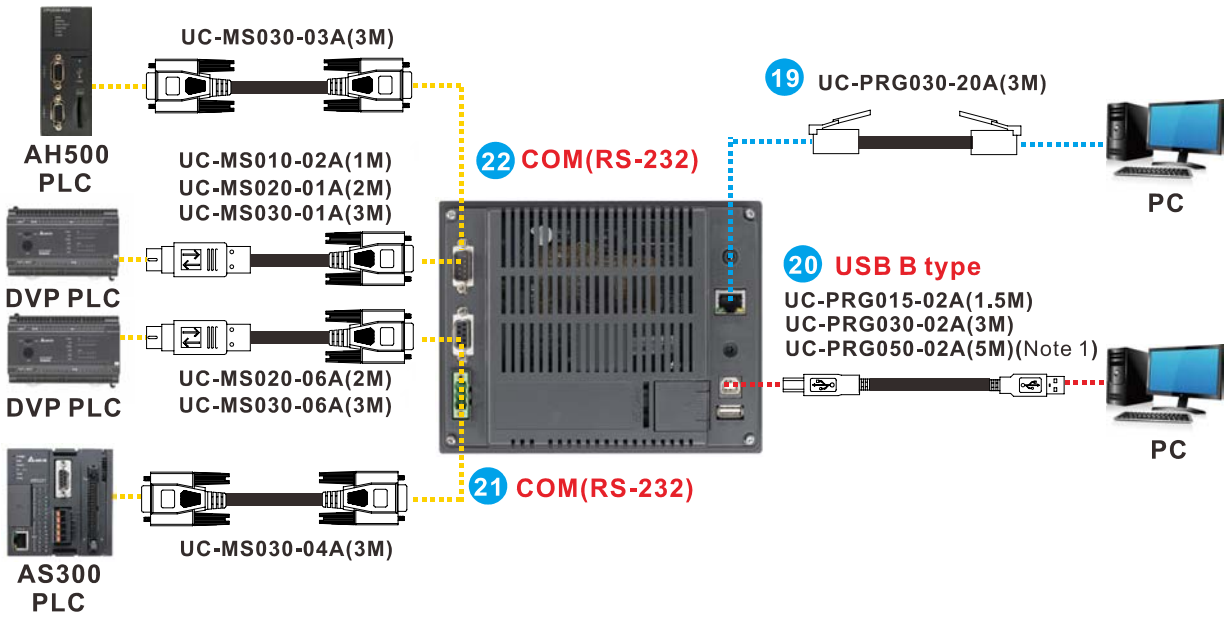

Note1: UC-PRG050-02A is used for transferring input signals between the interface panel and the controller. The cable is used exclusively for all-electric injection molding machines.

Note2: Please refer to section 1.21 for more information about **1**, **2**, **3**, etc.

DOP-B series (DOP-B08S515)

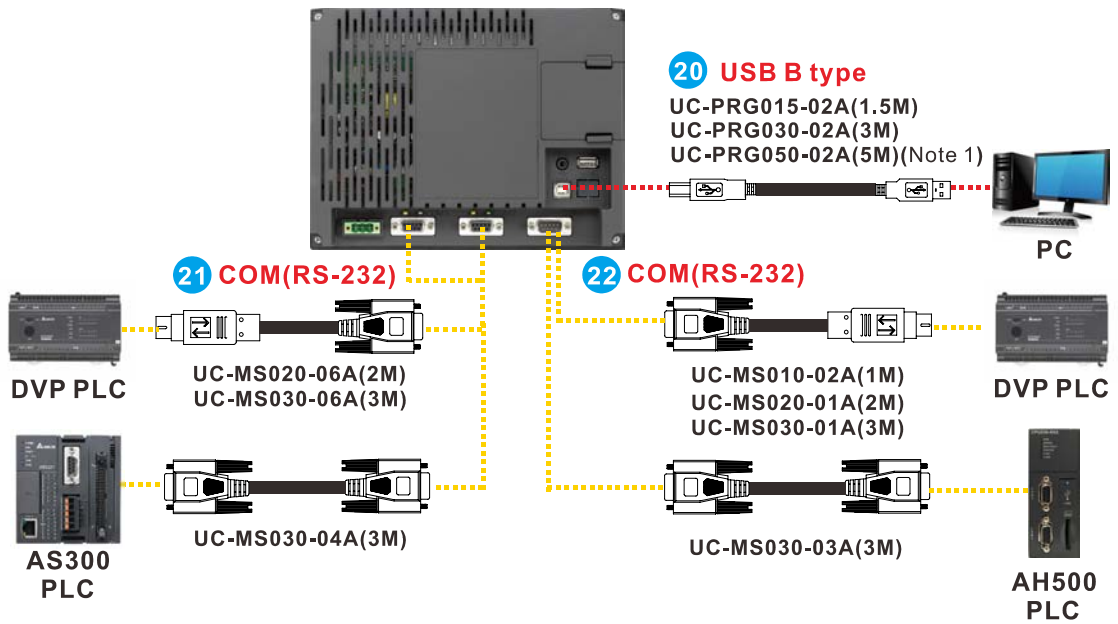

Note1: UC-PRG050-02A is used for transferring input signals between the interface panel and the controller. The cable is used exclusively for all-electric injection molding machines.

Note2: Please refer to section 1.21 for more information about 1, 2, 3, etc.

DOP-B series (DOP-B08E515)

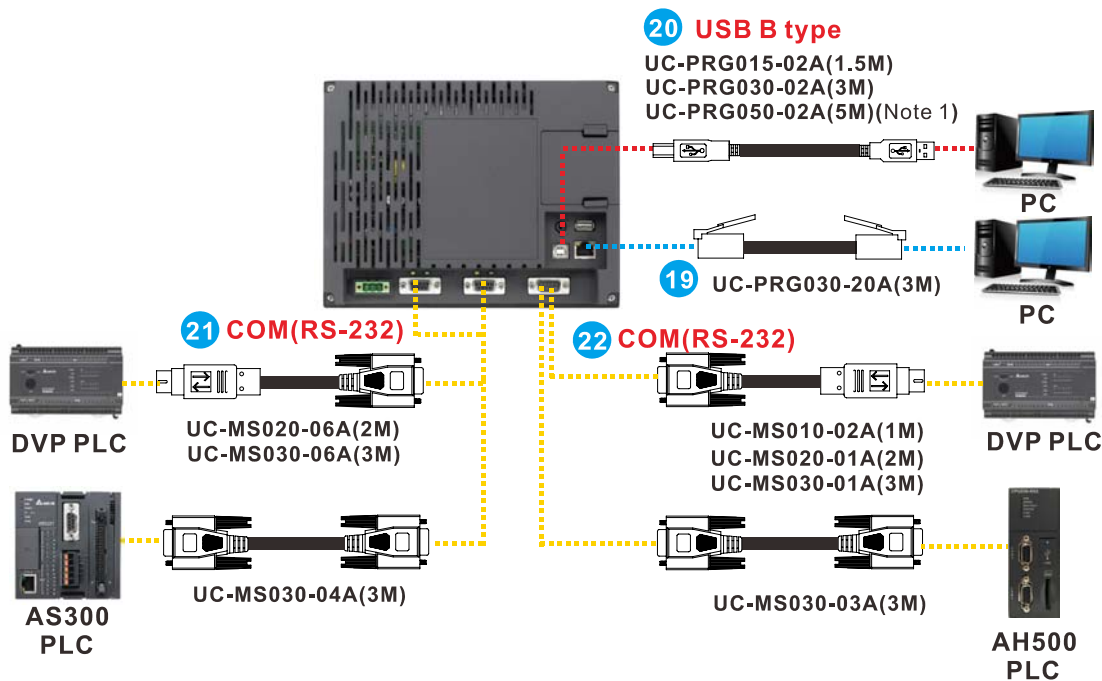

Note1: UC-PRG050-02A is used for transferring input signals between the interface panel and the controller. The cable is used exclusively for all-electric injection molding machines.

Note2: Please refer to section 1.21 for more information about **1**, **2**, **3**, etc.

DOP-B series (DOP-B10S411, DOP-B10S615)

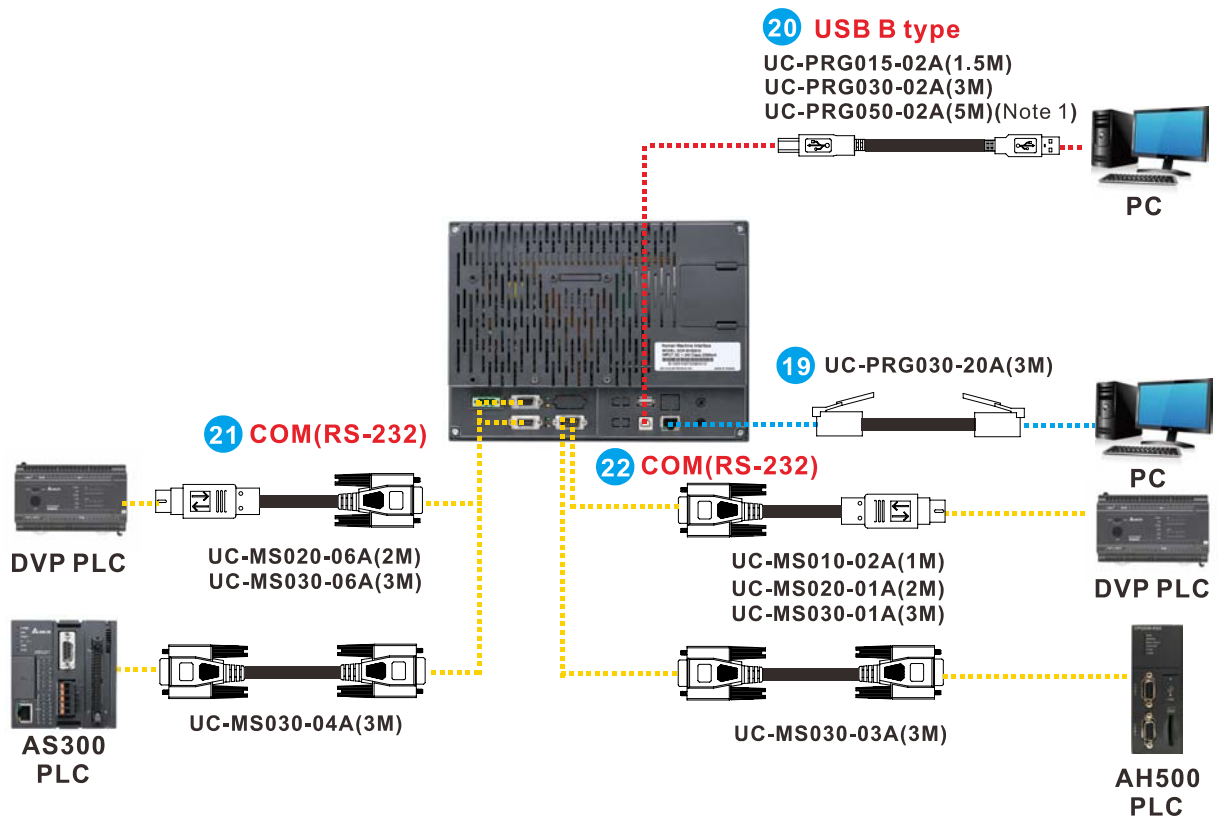

Note1: UC-PRG050-02A is used for transferring input signals between the interface panel and the controller. The cable is used exclusively for all-electric injection molding machines.

Note2: Please refer to section 1.21 for more information about 1, 2, 3, etc.

1

DOP-B series (DOP-B10E615)

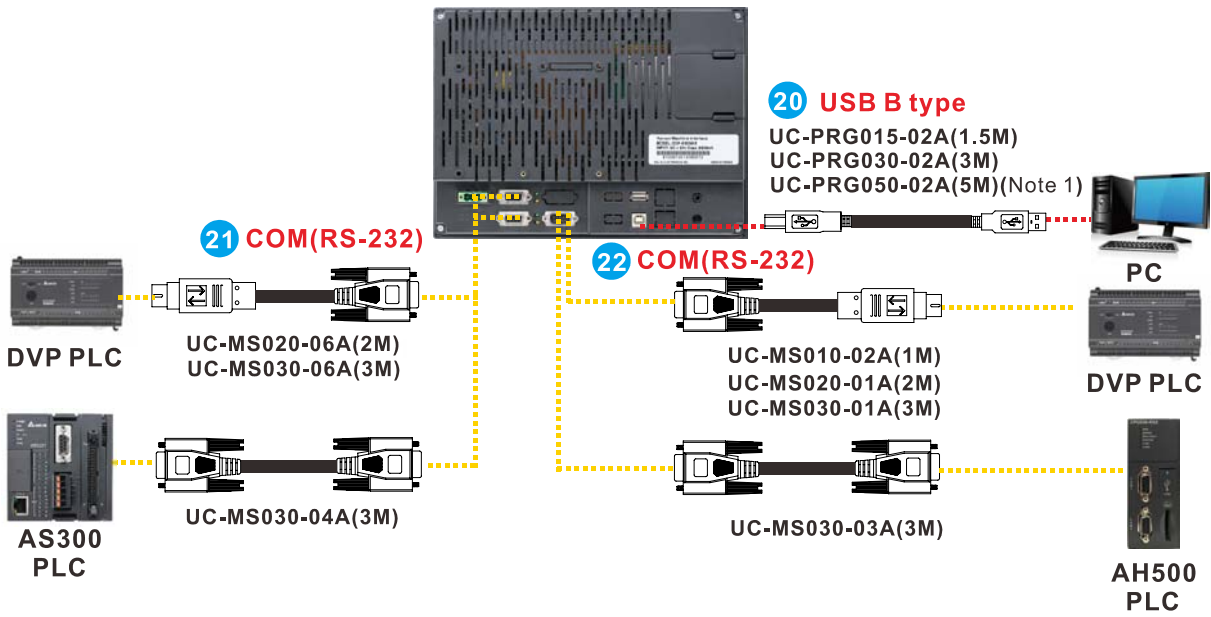

Note1: UC-PRG050-02A is used for transferring input signals between the interface panel and the controller. The cable is used exclusively for all-electric injection molding machines.

Note2: Please refer to section 1.21 for more information about **1**, **2**, **3**, etc.

DOP-B series (DOP-B10S511, DOP-B10VS511)

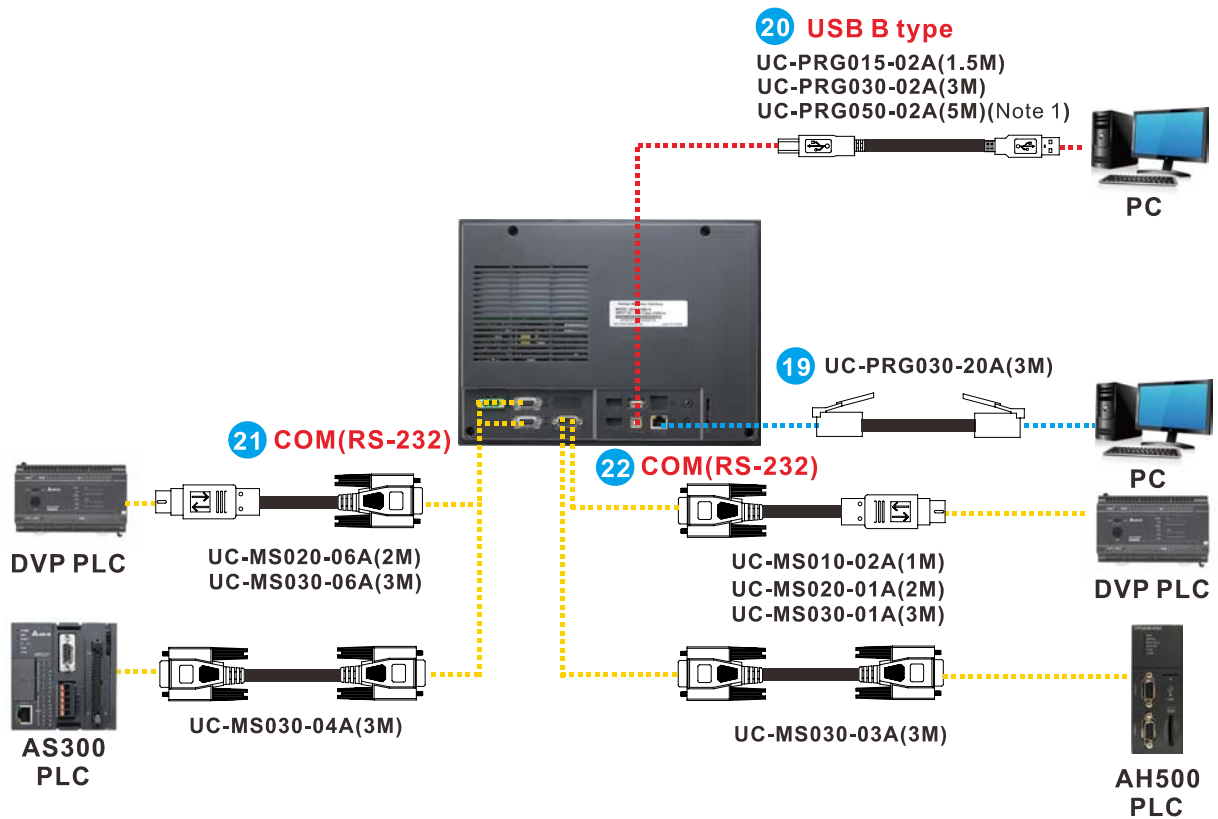

Note1: UC-PRG050-02A is used for transferring input signals between the interface panel and the controller. The cable is used exclusively for all-electric injection molding machines.

Note2: Please refer to section 1.21 for more information about 1, 2, 3, etc.

DOP-B series (DOP-B10E515)

1

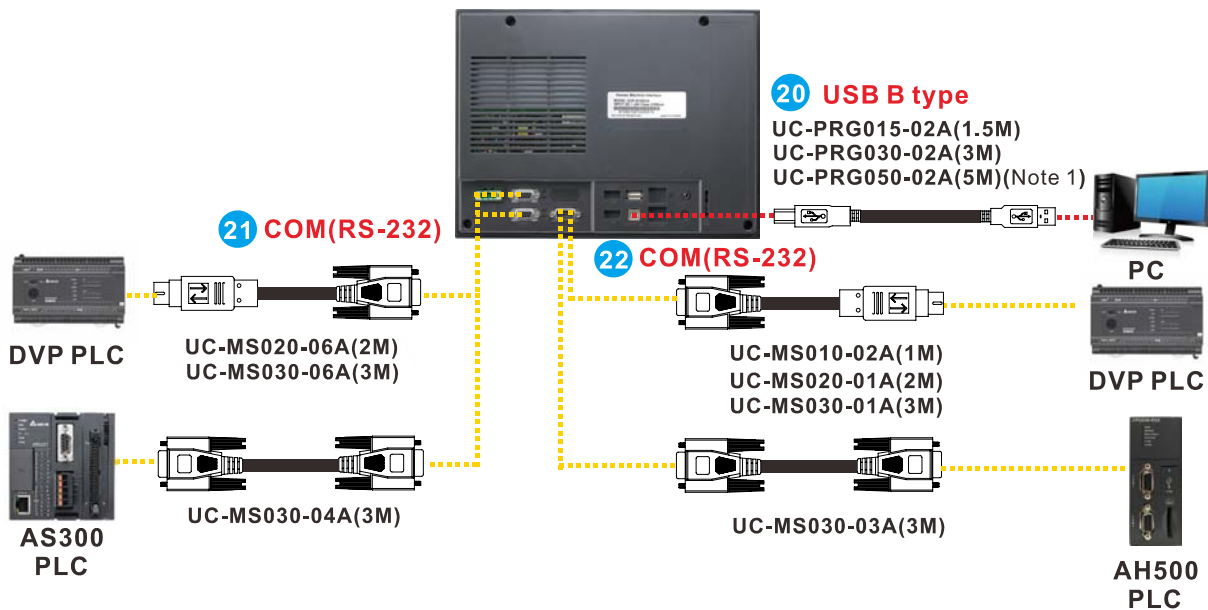

Note1: UC-PRG050-02A is used for transferring input signals between the interface panel and the controller. The cable is used exclusively for all-electric injection molding machines.

Note2: Please refer to section 1.21 for more information about **1**, **2**, **3**, etc.

1.18 DOP-W Series

DOP-W series (DOP-W105B, DOP-W127B)

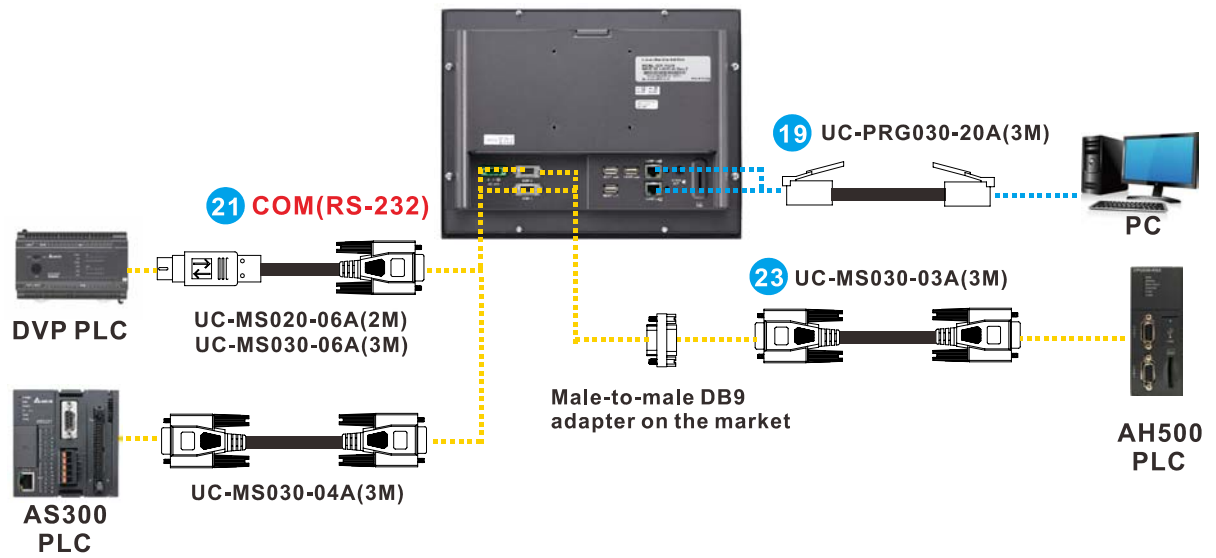

Note: Please refer to section 1.21 for more information about **1**, **2**, **3**, etc.

DOP-W series (DOP-W157B)

1

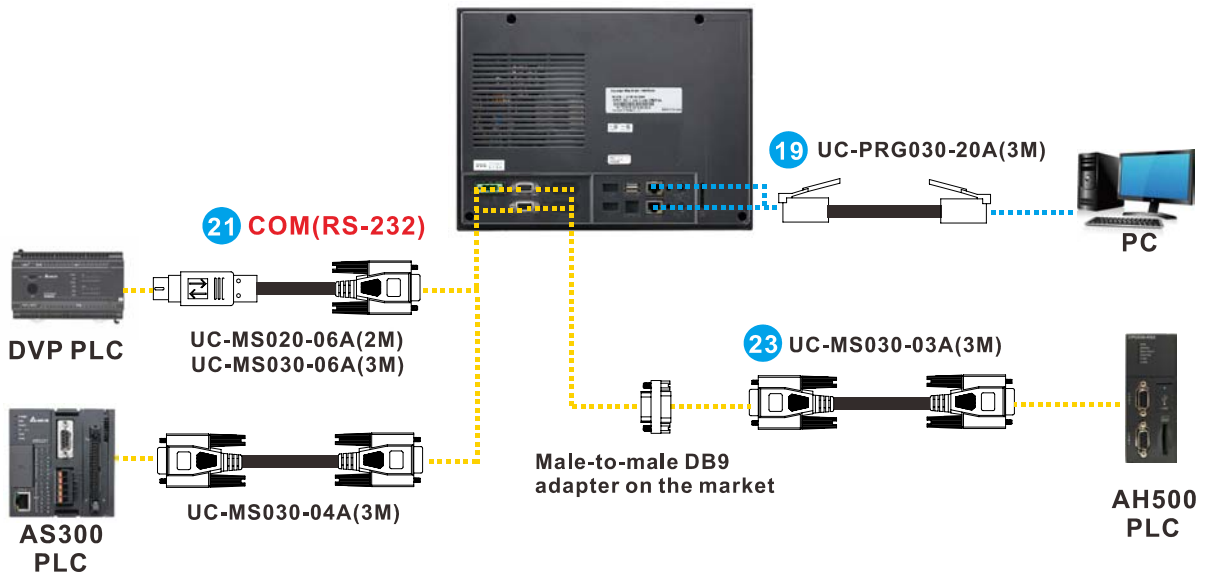

Note: Please refer to section 1.21 for more information about **1**, **2**, **3**, etc.

1.19 DOP Series HMIs and the Delta Machine Vision System (RS-232)

1

Applicable DOP series:

- **DOP-B series** (DOP-B03E211, DOP-B03S210, DOP-B03S211, DOP-B05S111, DOP-B07E415, DOP-B07E515, DOP-B07PS415, DOP-B07PS515, DOP-B07S401K, DOP-B07S410, DOP-B07S411, DOP-B07S411K, DOP-B07S415, DOP-B07S515, DOP-B08E515, DOP-B08S515, DOP-B10E515, DOP-B10E615, DOP-B10S411, DOP-B10S511, DOP-B10S615, DOP-B10VS511)
- **DOP-W series** (DOP-W105B, DOP-W127B, DOP-W157B)

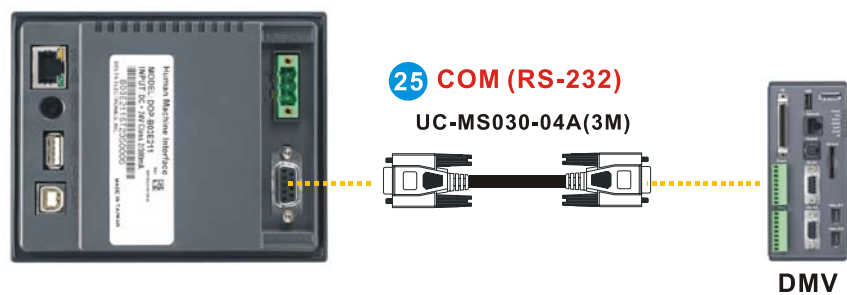

Note: Please refer to section 1.21 for more information about **1**, **2**, **3**, etc.

1.20 DOP Series HMIs and the Delta Machine Vision System (Ethernet)

1

Applicable DOP series:

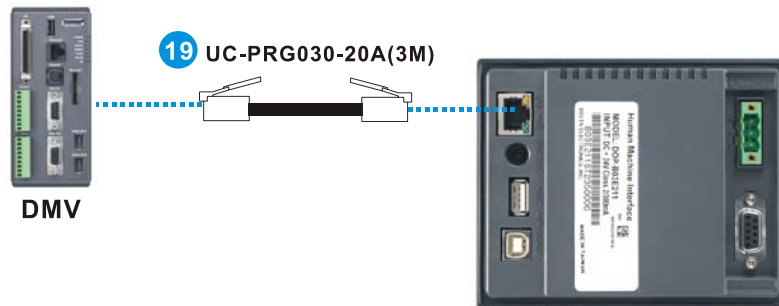

- **DOP-B series** (DOP-B03E211, DOP-B07E415, DOP-B07E515, DOP-B08E515, DOP-B10E515, DOP-B10E615)
- **DOP-W series**(DOP-W105B, DOP-W127B, DOP-W157B)







Note: Please refer to section 1.21 for more information about [1](#), [2](#), [3](#), etc.

1.21 Cable Models

1 COM1 (RS-232)



CPU	Adapter	Module/Interface card	Cable	Machine connected
PLC	--	--	8-pin male min-DIN connector ↔ Female DB9 connector	PC/HMI/TP
			UC-MS010-02A (1 m) (Figure 1)	
			UC-MS020-01A (2 m) (Figure 2)	
			UC-MS030-01A (3 m) (Figure 2)	



CPU	Adapter	Module/Interface card	Cable	Machine connected
PLC	--	--	8-pin male mini-DIN connector ↔ USB connector	PC
			UC-PRG020-12A (2M) (Figure 3A)	

CPU	Adapter	Module/Interface card	Cable	Machine connected
PLC	--	--	8-pin male mini-DIN connector ↔ Male DB9 connector	HMI
			UC-MS020-06A (2 m) (Figure 4)	
			UC-MS030-06A (3 m) (Figure 4)	

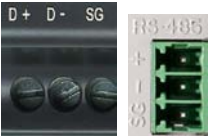

1



2 COM2 (RS-485)

CPU	Adapter	Module/Interface card	Cable	Machine connected
PLC	--	--	RS-485 ↔ USB	PC
			IFD6500 (Figure 5)	



CPU	Adapter	Module/Interface card	Cable	Machine connected
PLC	--	--	RS-485 ↔ RS-232	PC
			IFD8500 (Figure 6)	

3 COM3 (RS-485)



CPU	Adapter	Module/Interface card	Cable	Machine connected
PLC	--	--	RS-485 ↔ USB	PC
			IFD6500 (Figure 5)	

CPU	Adapter	Module/Interface card	Cable	Machine connected
PLC	--	--	RS-485 ↔ RS-232	PC
			IFD8500 (Figure 6)	
				



4 Mini USB

CPU	Adapter	Module/Interface card	Cable	Machine connected
PLC	--	--	Mini USB ↔ USB	PC
			UC-PRG015-01A (1.5 m) (Figure 10)	
			UC-PRG030-01A (3 m) (Figure 10)	

5 COM1/COM2 (RS-485)



CPU	Adapter	Module/Interface card	Cable	Machine connected
PLC	--	DVPSCM12-SL (Figure 9) DVPSCM52-SL (Figure 9)	RS-485 ↔ USB	PC
			IFD6500 (Figure 5)	



1



CPU	Adapter	Module/Interface card	Cable	Machine connected
PLC	--	--	RS-485 ↔ RS-232	PC
			IFD8500 (Figure 6)	



6

RS-232

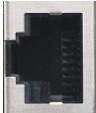

CPU	Adapter	Module/Interface card	Cable	Machine connected
PLC	--	DVPEN01-SL (Figure 8)	8-pin male mini-DIN connector ↔ Female DB9 connector	PC/HMI/TP
			UC-MS010-02A (1 m) (Figure 1)	
			UC-MS020-01A (2 m) (Figure 2)	
			UC-MS030-01A (3 m) (Figure 2)	

CPU	Adapter	Module/Interface card	Cable	Machine connected
PLC	--	DVPEN01-SL (Figure 8)	8-pin male mini-DIN connector ↔ Male DB9 connector	HMI
			UC-MS020-06A (2 m) (Figure 4)	
			UC-MS030-06A (3 m) (Figure 4)	

CPU	Adapter	Module/Interface card	Cable	Machine connected
PLC	--	DVPEN01-SL (Figure 8)	8-pin male mini-DIN connector ↔ USB connector	PC
			UC-PRG020-12A (2M) (Figure 3A)	

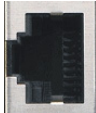

CPU	Adapter	Module/Interface card	Cable	Machine connected
PLC	--	DVPEN01-SL (Figure 8)	RJ45 ↔ RJ45	PC/HMI
			UC-PRG030-20A (3M) (Figure 7)	



7 Ethernet



CPU	Adapter	Module/Interface card	Cable	Machine connected
PLC	--	--	RJ45 ↔ RJ45	PC/HMI
			UC-PRG030-20A (3M) (Figure 7)	

1

8 COM3 (RS-232)



CPU	Adapter	Module/Interface card	Cable	Machine connected
PLC	--	DVP-FEN01 (Figure 14)	8-pin male mini-DIN connector ↔ Female DB9 connector	PC/HMI/TP
			UC-MS010-02A (1 m) (Figure 1)	
			UC-MS020-01A (2 m) (Figure 2)	
			UC-MS030-01A (3 m) (Figure 2)	

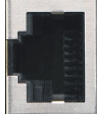

CPU	Adapter	Module/Interface card	Cable	Machine connected
PLC	--	DVP-FEN01 (Figure 14)	8-pin male mini-DIN connector ↔ Male DB9 connector	HMI
			UC-MS020-06A (2 m) (Figure 4)	
			UC-MS030-06A (3 m) (Figure 4)	

CPU	Adapter	Module/Interface card	Cable	Machine connected
PLC	--	DVP-FEN01 (Figure 14)	8-pin male mini-DIN connector ↔ USB connector	PC
			UC-PRG020-12A (2M) (Figure 3A)	

CPU	Adapter	Module/Interface card	Cable	Machine connected
PLC	--	DVP-FEN01 (Figure 14)	RJ45 ↔ RJ45	PC/HMI
			UC-PRG030-20A (3M) (Figure 7)	



9 COM3 (RS-232)



CPU	Adapter	Module/Interface card	Cable	Machine connected
PLC	--	DVP-F232 (Figure 15)	Female DB9 connector ↔ USB connector	PC
			UC-PRG020-12A (2M) (Figure 3B)	

CPU	Adapter	Module/Interface card	Cable	Machine connected
PLC	--	DVP-F232 (Figure 15)	Female DB9 connector ↔ Female DB9 connector	PC
			UC-PRG030-10A (3M) (Figure 12)	



1



10 COM3 (RS-485)

CPU	Adapter	Module/Interface card	Cable	Machine connected
PLC	--	DVP-F485 (Figure 16)	RS-485 ↔ USB	PC
			IFD6500 (Figure 5)	



CPU	Adapter	Module/Interface card	Cable	Machine connected
PLC	--	DVP-F485 (Figure 16)	RS-485 ↔ RS-232	PC
			IFD8500 (Figure 6)	



11 COM3 (RS-232)

CPU	Adapter	Module/Interface card	Cable	Machine connected
PLC	Male-to-male null modem adapter	F232S (Figure 11)	Female DB9 connector ↔ USB connector	PC
			UC-PRG020-12A (2M) (Figure 3B)	

CPU	Adapter	Module/Interface card	Cable	Machine connected
PLC	Male-to-male null modem adapter	F232S (Figure 11)	Female DB9 connector ↔ Female DB9 connector	PC
			UC-PRG030-10A (3M) (Figure 12)	



12 COM3 (RS-485)



CPU	Adapter	Module/Interface card	Cable	Machine connected
PLC	--	F485S (Figure 13)	RS-485 ↔ USB	PC
			IFD6500 (Figure 5)	



CPU	Adapter	Module/Interface card	Cable	Machine connected
PLC	--	F485S (Figure 13)	RS-485 ↔ RS-232	PC
			IFD8500 (Figure 6)	



1

13 COM1 (RS-232)



CPU	Adapter	Module/Interface card	Cable	Machine connected
TP	--	--	Female DB9 connector ↔ USB connector	PC
			UC-PRG020-12A (2M) (Figure 3B)	

CPU	Adapter	Module/Interface card	Cable	Machine connected
TP	--	--	Female DB9 connector ↔ Female DB9 connector	PC
			UC-PRG030-10A (3M) (Figure 12)	



CPU	Adapter	Module/Interface card	Cable	Machine connected
TP	--	--	Female DB9 connector ↔ 8-pin male mini-DIN connector	DVP PLC
			UC-MS010-02A (1 m) (Figure 1)	
			UC-MS020-01A (2 m) (Figure 2)	
			UC-MS030-01A (3 m) (Figure 2)	

CPU	Adapter	Module/Interface card	Cable	Machine connected
TP	--	--	Female DB9 connector ↔ Male DB9 connector	AH500
			UC-MS030-03A (3M) (Figure 18)	



14 USB Type-B

CPU	Adapter	Module/Interface card	Cable	Machine connected
TP	--	--	USB Type-B ↔ USB Type-A	PC
			UC-PRG015-02A (1.5 m) (Figure 19)	
			UC-PRG030-02A (3 m) (Figure 19)	



15 COM (RS-485)

CPU	Adapter	Module/Interface card	Cable	Machine connected
AH500	--	AH10SCM-5A (Figure 21)	RS-485 ↔ USB	PC
			IFD6500 (Figure 5)	



1



CPU	Adapter	Module/Interface card	Cable	Machine connected
AH500	--	AH10SCM-5A (Figure 21)	RS-485 ↔ RS-232	PC
			IFD8500 (Figure 6)	



16 COM (RS-485)



CPU	Adapter	Module/Interface card	Cable	Machine connected
AH500	--	AH10EN-5A (Figure 20)	RJ45 ↔ RJ45	PC/HMI
			UC-PRG030-20A (3M) (Figure 7)	

17 COM (RS-232)



CPU	Adapter	Module/Interface card	Cable	Machine connected
AH500	Male-to-male DB9 adapter (cable accessory)	--	Female DB9 connector ↔ USB connector	PC
			UC-PRG020-12A (2M) (Figure 3B)	



CPU	Adapter	Module/Interface card	Cable	Machine connected
AH500	Male-to-male DB9 adapter	--	Female DB9 connector ↔ Female DB9 connector	PC
			UC-PRG030-10A (3M) (Figure 12)	

CPU	Adapter	Module/Interface card	Cable	Machine connected
AH500	Male-to-male DB9 adapter	--	Female DB9 connector ↔ Male DB9 connector	PC/TP/HMI
			UC-MS030-03A (3M) (Figure 18)	



CPU	Adapter	Module/Interface card	Cable	Machine connected
AH500	--	--	Male DB9 connector ↔ Male DB9 connector	DMV
			UC-MS030-04A (3M) (Figure 17)	



1



CPU	Adapter	Module/Interface card	Cable	Machine connected
AS300	--	AS-F232 (Figure 22)	Male DB9 connector ↔ Female DB9 connector	PC/TP/HMI
			Standard cable on the marker	



CPU	Adapter	Module/Interface card	Cable	Machine connected
AS300	Male-to-male DB9 adapter	--	Female DB9 connector ↔ Male DB9 connector	DMV
			UC-MS030-03A (3M) (Figure 18)	

18 COM (RS-485)



CPU	Adapter	Module/Interface card	Cable	Machine connected
AH500	--	--	RS-485 ↔ USB	PC
			IFD6500 (Figure 5)	

CPU	Adapter	Module/Interface card	Cable	Machine connected
AH500	--	--	RS-485 ↔ RS-232	PC
			IFD8500 (Figure 6)	

CPU	Adapter	Module/Interface card	Cable	Machine connected
AS300	--	AS-F485 (Figure 22)	RS-485 ↔ USB	PC
			IFD6500 (Figure 5)	



CPU	Adapter	Module/Interface card	Cable	Machine connected
AS300	--	AS-F485 (Figure 23)	RS-485 ↔ RS-232	PC
			IFD8500 (Figure 6)	

1**19** Ethernet

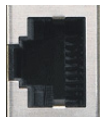
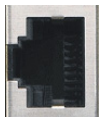

CPU	Adapter	Module/Interface card	Cable	Machine connected
DOP	--	--	RJ45 ↔ RJ45	PC
			UC-PRG030-20A (3M) (Figure 7)	



CPU	Adapter	Module/Interface card	Cable	Machine connected
DOP	--	--	RJ45 ↔ RJ45	DMV
			UC-PRG030-20A (3M) (Figure 7)	

20 USB Type-B



CPU	Adapter	Module/Interface card	Cable	Machine connected
DOP	--	--	USB Type-B ↔ USB Type-A	PC
			UC-PRG015-02A (1.5 m) (Figure 19)	
			UC-PRG030-02A (3 m) (Figure 19)	
			UC-PRG050-02A (5M) (Figure 19)	

21 COM (RS-232)



CPU	Adapter	Module/Interface card	Cable	Machine connected
DOP	--	--	Male DB9 connector ↔ 8-pin male mini-DIN connector	PLC
			UC-MS020-06A (2 m) (Figure 4)	
			UC-MS030-06A (3 m) (Figure 4)	

CPU	Adapter	Module/Interface card	Cable	Machine connected
DOP	--	--	Male DB9 connector ↔ Male DB9 connector	AS300
			UC-MS030-04A (3M) (Figure 17)	



22 COM (RS-232)

CPU	Adapter	Module/Interface card	Cable	Machine connected
DOP	--	--	Female DB9 connector ↔ 8-pin male mini-DIN connector	PLC
			UC-MS010-02A (1 m) (Figure 1)	
			UC-MS020-01A (2 m) (Figure 2)	
			UC-MS030-01A (3 m) (Figure 2)	



1

CPU	Adapter	Module/Interface card	Cable	Machine connected
DOP	--	--	Female DB9 connector ↔ Male DB9 connector	AH500
			UC-MS030-03A (3 m) (Figure 18)	



23 COM (RS-232)

CPU	Adapter	Module/Interface card	Cable	Machine connected
DOP	Male-to-male DB9 adapter	--	Female DB9 connector ↔ Male DB9 connector	AH500
			UC-MS030-03A (3 m) (Figure 18)	



24 COM (RS-232)

CPU	Adapter	Module/Interface card	Cable	Machine connected
PLC	--	--	8-pin male mini-DIN connector ↔ Male DB9 connector	DMV
			UC-MS020-06A (2 m) (Figure 4)	
			UC-MS030-06A (3 m) (Figure 4)	

25 COM (RS-232)

CPU	Adapter	Module/Interface card	Cable	Machine connected
DOP	--	--	Male DB9 connector ↔ Male DB9 connector	DMV
			UC-MS030-04A (3 m) (Figure 17)	

26 COM (RS-232)

CPU	Adapter	Module/Interface card	Cable	Machine connected
DOP	--	--	Male DB9 connector ↔ Male DB9 connector	AS300
			UC-MS030-04A (3 m) (Figure 17)	

1.22 Descriptions of Cable Models

1

Figure 1 UC-MS010-02A (1 m) 8-pin male mini-DIN connector (90 degrees) ↔ Female DB9 connector

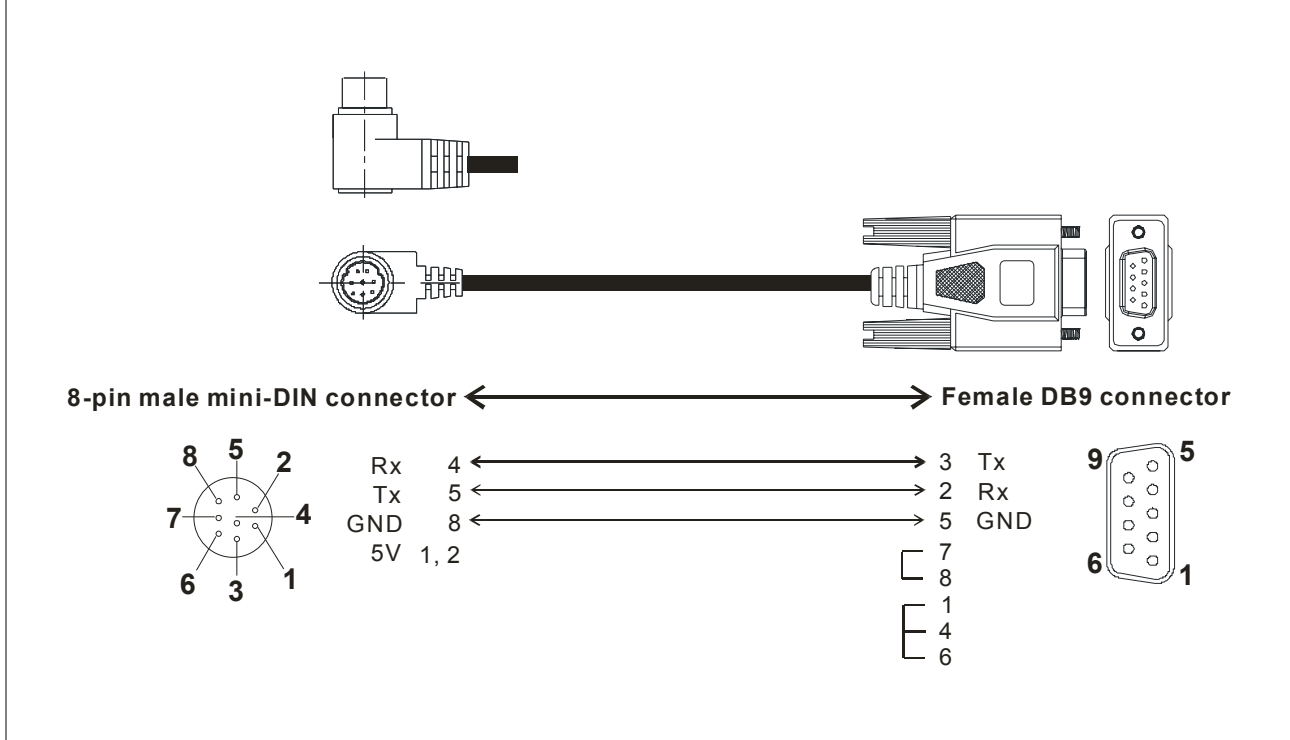

Figure 2 UC-MS020-01A (2 m) UC-MS030-01A (3 m) 8-pin male mini-DIN connector ↔ Female DB9 connector

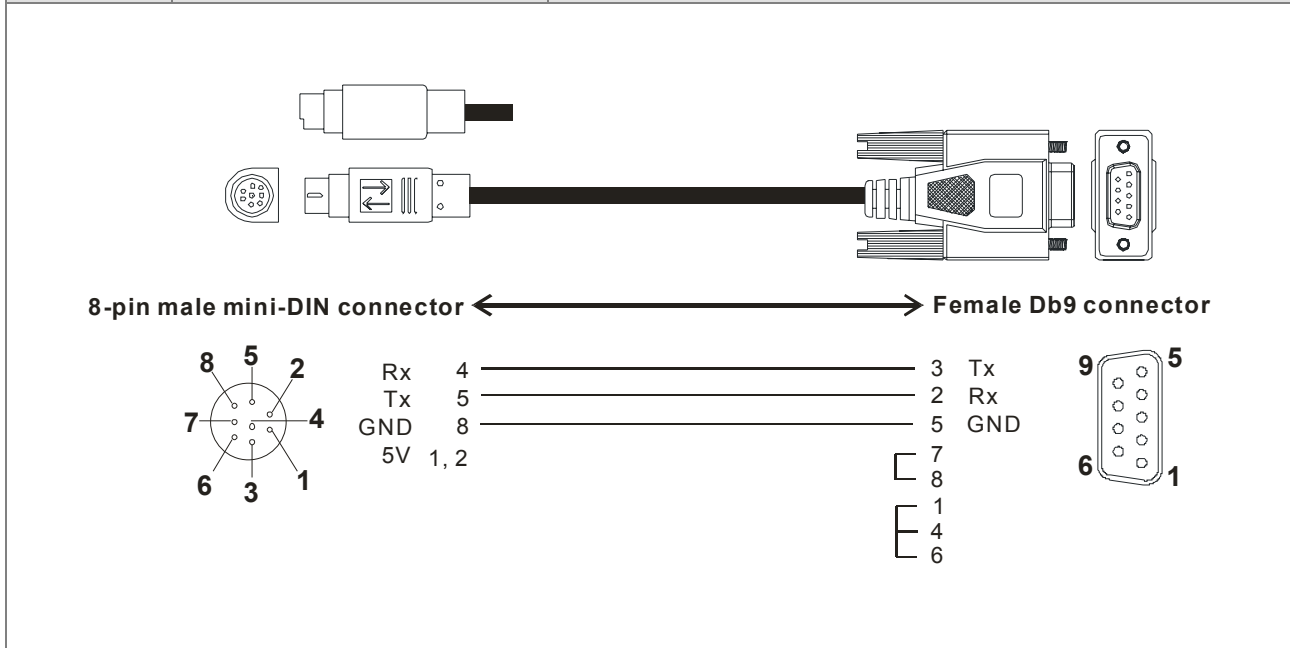
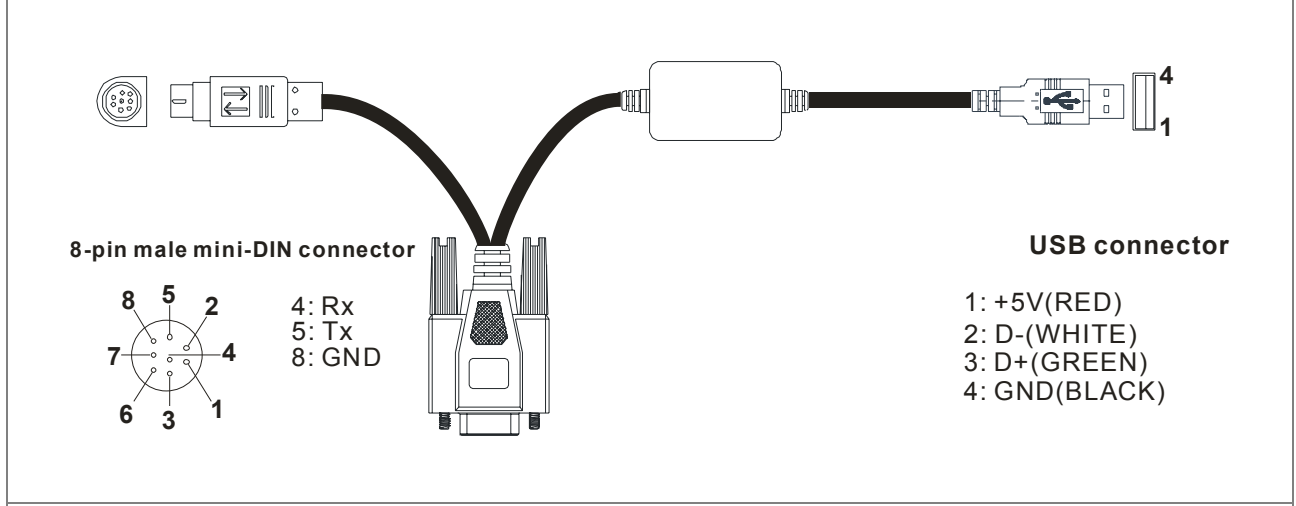
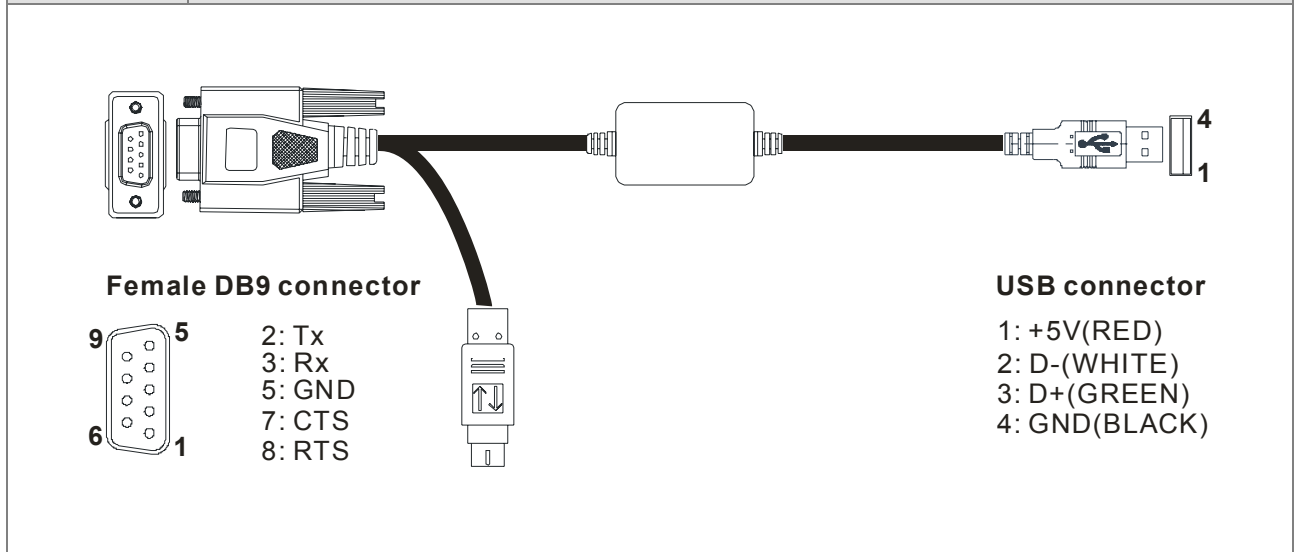

Figure 3A	UC-PRG020-12A (2 m)	8-pin male mini-DIN connector ↔ USB connector
	(Accessory: Male-to-male DB9 adapter)	



◆ **Note:** Please refer to Appendix B for more information about installing a USB driver.

Figure 3B	UC-PRG020-12A (2 m)	Female DB9 connector ↔ USB connector
	(Accessory: Male-to-male DB9 adapter)	



◆ **Note:** Please refer to Appendix B for more information about installing a USB driver.

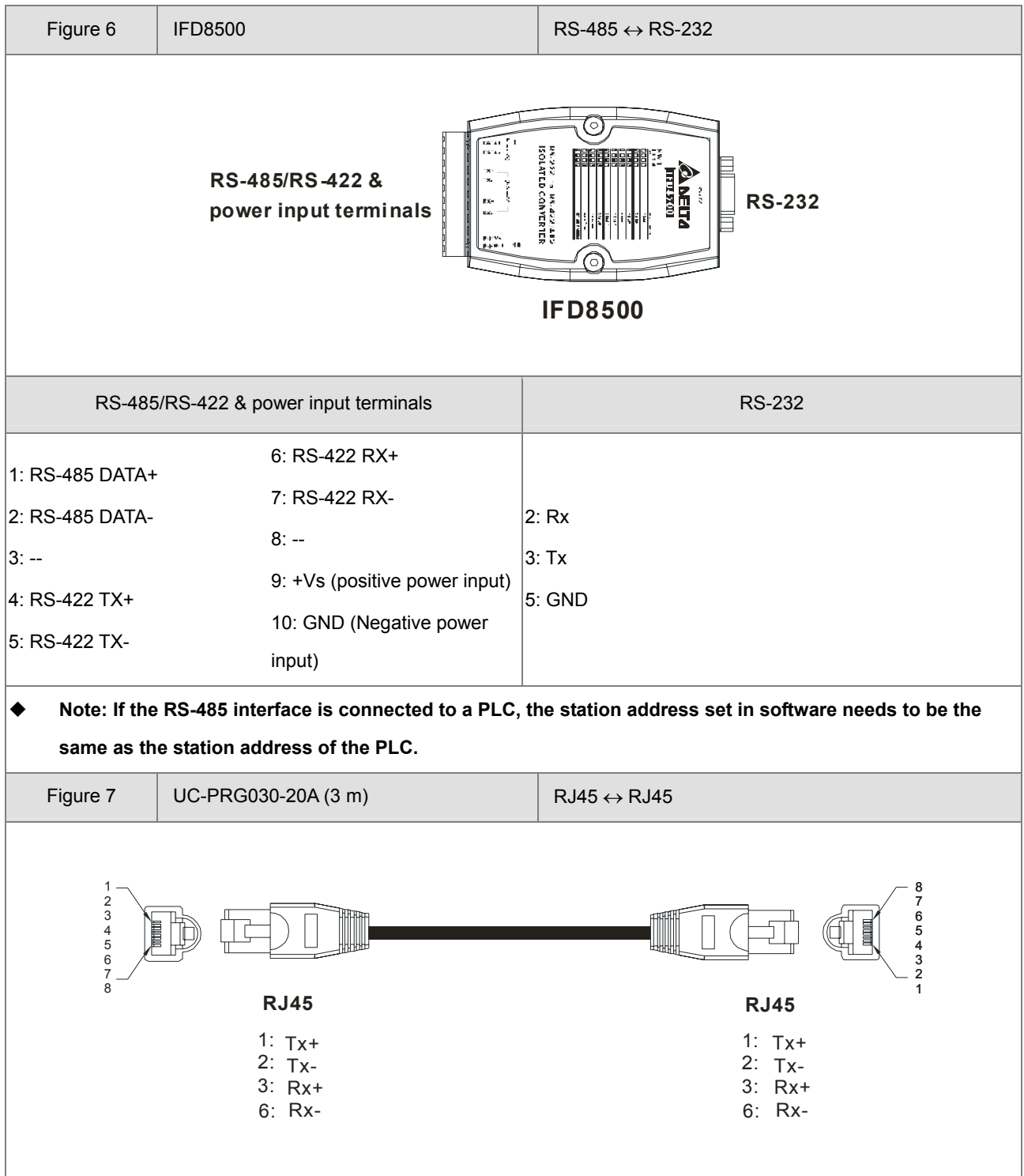

1

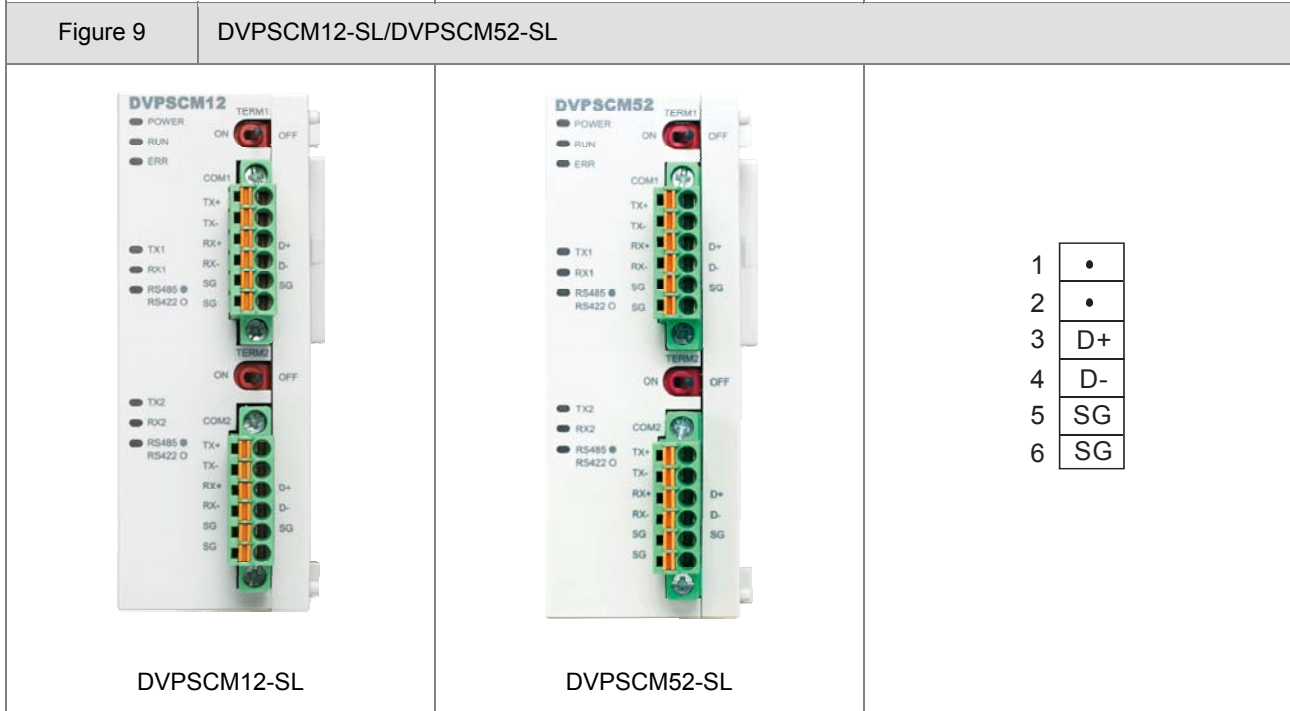
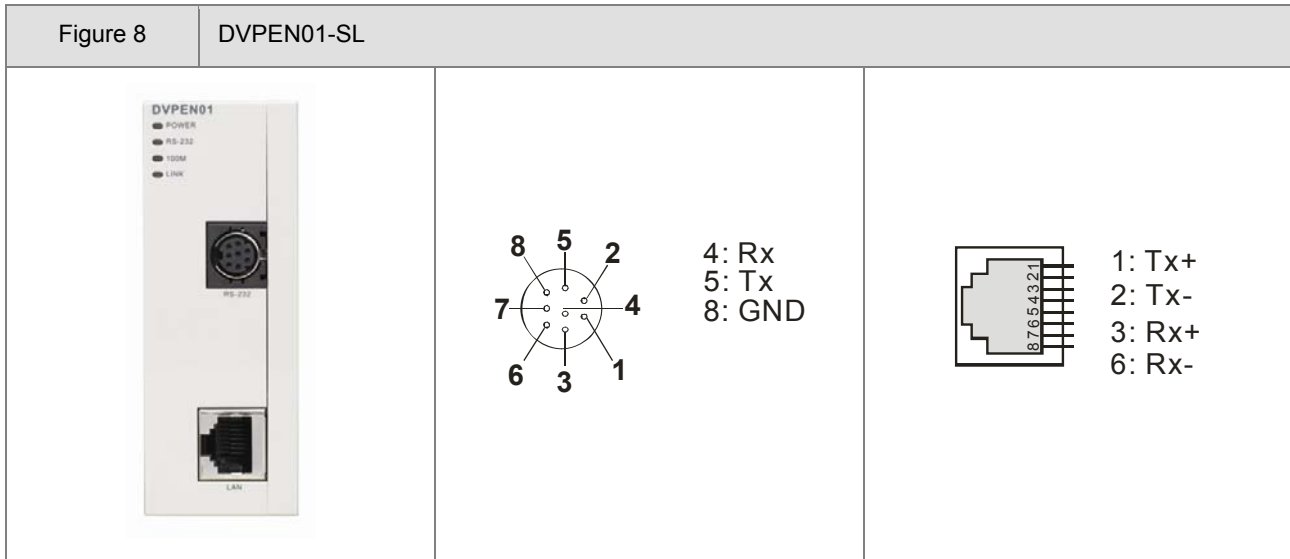

Figure 10 UC-PRG015-01A (1.5 m)
UC-PRG030-01A (3 m) Mini USB ↔ USB

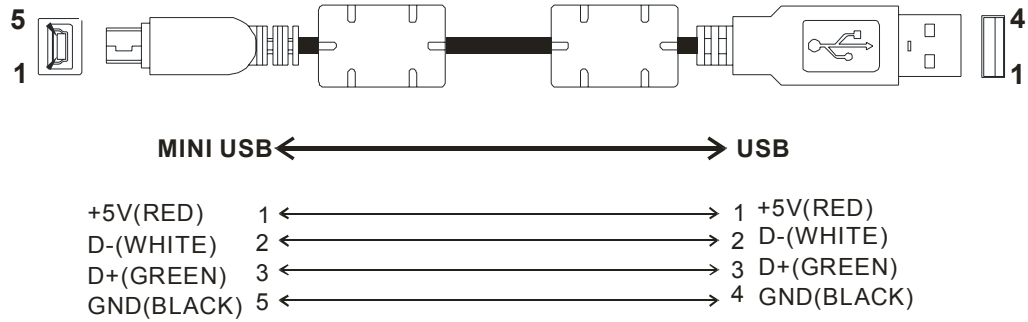

Figure 11 F232S

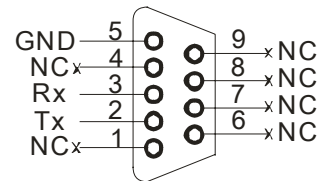
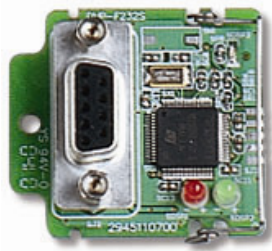
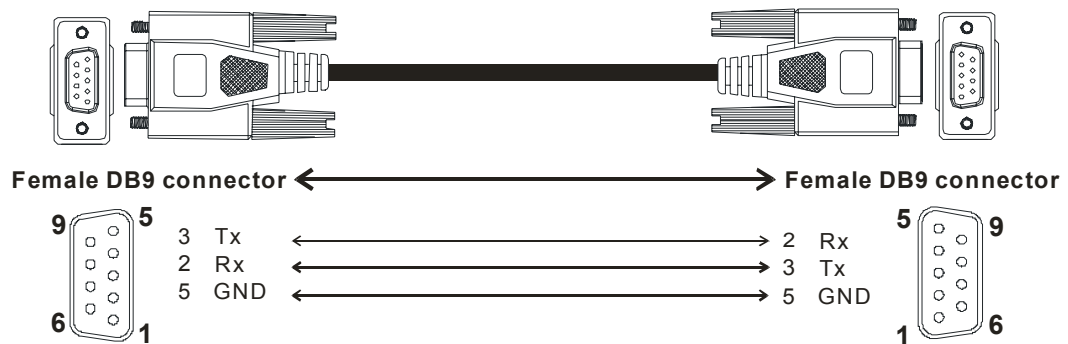

Figure 12 UC-PRG030-10A (3 m) Female DB9 connector ↔ Female DB9 connector



1

Figure 12 UC-PRG030-10A (3 m) Female DB9 connector ↔ Female DB9 connector + Null modem adapter

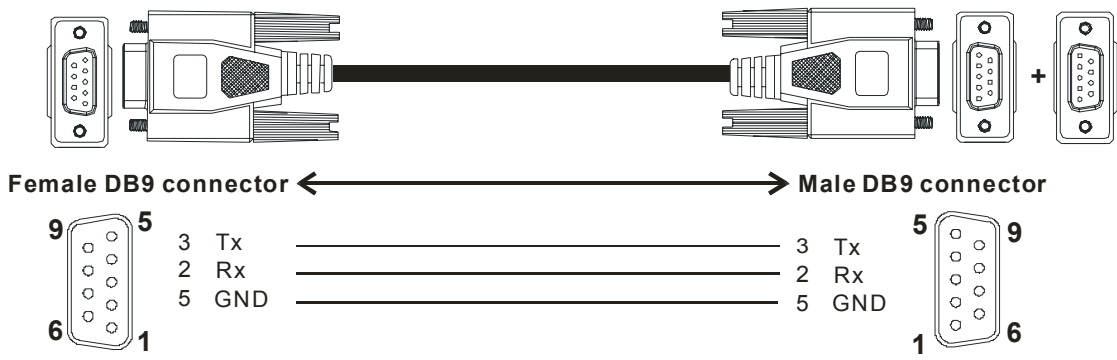
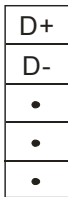
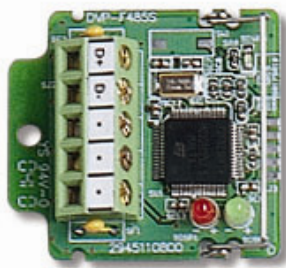

Figure 13 F485S





D+: Signal (+ pole)
D-: Signal (- pole)

Figure 14 DVP-FEN01



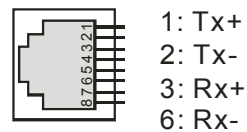
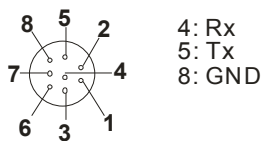

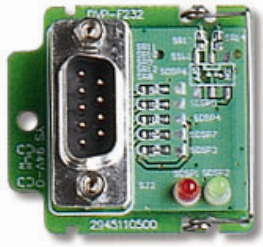
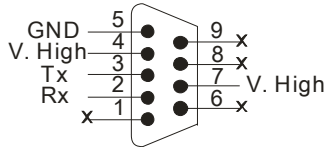

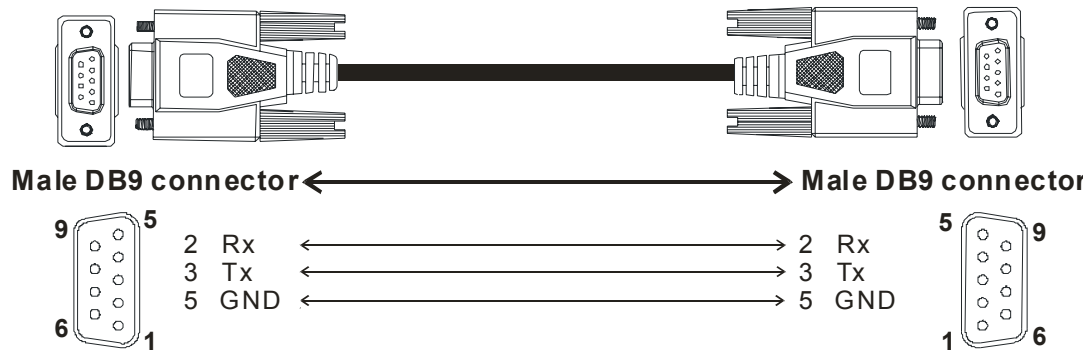
8-pin male mini-DIN connector

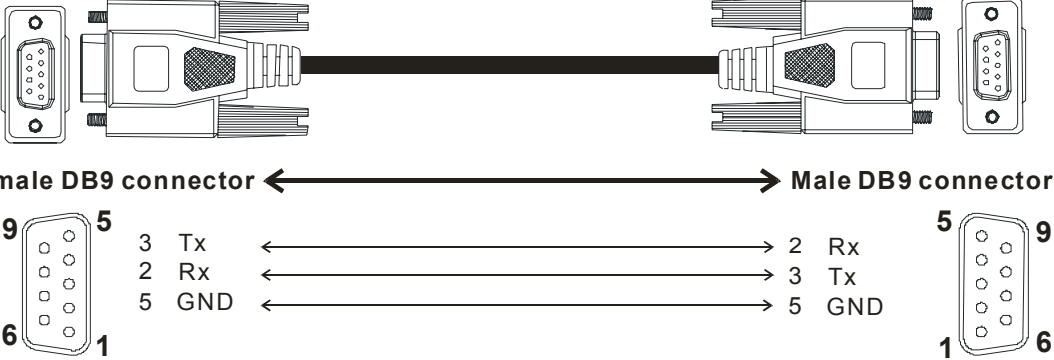

<p>Figure 15</p>	<p>F232</p>																													
	 <p>V. High: High electrical potential, i.e. logical value 1</p>																													
<p>Figure 16</p>	<p>F485</p>																													
	<table border="1" data-bbox="798 795 869 996"> <tr><td>D+</td></tr> <tr><td>D-</td></tr> <tr><td>•</td></tr> <tr><td>•</td></tr> <tr><td>•</td></tr> </table> <p>D+: Signal (+ pole) D-: Signal (- pole)</p>	D+	D-	•	•	•																								
D+																														
D-																														
•																														
•																														
•																														
<p>Figure 17</p>	<p>UC-MS030-04A (3 m)</p>	<p>Male DB9 connector ↔ Male DB9 connector</p>																												
 <p>Male DB9 connector ← → Male DB9 connector</p> <p> <table border="0"> <tr> <td>9</td> <td>5</td> <td>2 Rx</td> <td>←</td> <td>2 Rx</td> <td>5</td> <td>9</td> </tr> <tr> <td></td> <td></td> <td>3 Tx</td> <td>←</td> <td>3 Tx</td> <td></td> <td></td> </tr> <tr> <td>6</td> <td></td> <td>5 GND</td> <td>←</td> <td>5 GND</td> <td></td> <td>6</td> </tr> <tr> <td></td> <td>1</td> <td></td> <td></td> <td></td> <td></td> <td>1</td> </tr> </table> </p>			9	5	2 Rx	←	2 Rx	5	9			3 Tx	←	3 Tx			6		5 GND	←	5 GND		6		1					1
9	5	2 Rx	←	2 Rx	5	9																								
		3 Tx	←	3 Tx																										
6		5 GND	←	5 GND		6																								
	1					1																								

1

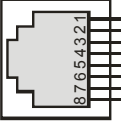
Figure 18	UC-MS030-03A (3 m)	Female DB9 connector ↔ Male DB9 connector																									
 <p>Female DB9 connector ← → Male DB9 connector</p> <table border="0" style="width: 100%; border-collapse: collapse;"> <tr> <td style="text-align: center; vertical-align: middle;"> <table border="0" style="margin: 0 auto;"> <tr><td style="text-align: right;">9</td><td style="text-align: left;">5</td></tr> <tr><td style="text-align: right;">6</td><td style="text-align: left;">1</td></tr> </table> </td> <td style="text-align: center; vertical-align: middle;"> <table border="0" style="margin: 0 auto;"> <tr><td style="text-align: right;">3 Tx</td><td style="text-align: left;">←</td><td style="text-align: right;">→</td><td style="text-align: left;">2 Rx</td></tr> <tr><td style="text-align: right;">2 Rx</td><td style="text-align: left;">←</td><td style="text-align: right;">→</td><td style="text-align: left;">3 Tx</td></tr> <tr><td style="text-align: right;">5 GND</td><td style="text-align: left;">←</td><td style="text-align: right;">→</td><td style="text-align: left;">5 GND</td></tr> </table> </td> <td style="text-align: center; vertical-align: middle;"> <table border="0" style="margin: 0 auto;"> <tr><td style="text-align: right;">5</td><td style="text-align: left;">9</td></tr> <tr><td style="text-align: right;">1</td><td style="text-align: left;">6</td></tr> </table> </td> </tr> </table>			<table border="0" style="margin: 0 auto;"> <tr><td style="text-align: right;">9</td><td style="text-align: left;">5</td></tr> <tr><td style="text-align: right;">6</td><td style="text-align: left;">1</td></tr> </table>	9	5	6	1	<table border="0" style="margin: 0 auto;"> <tr><td style="text-align: right;">3 Tx</td><td style="text-align: left;">←</td><td style="text-align: right;">→</td><td style="text-align: left;">2 Rx</td></tr> <tr><td style="text-align: right;">2 Rx</td><td style="text-align: left;">←</td><td style="text-align: right;">→</td><td style="text-align: left;">3 Tx</td></tr> <tr><td style="text-align: right;">5 GND</td><td style="text-align: left;">←</td><td style="text-align: right;">→</td><td style="text-align: left;">5 GND</td></tr> </table>	3 Tx	←	→	2 Rx	2 Rx	←	→	3 Tx	5 GND	←	→	5 GND	<table border="0" style="margin: 0 auto;"> <tr><td style="text-align: right;">5</td><td style="text-align: left;">9</td></tr> <tr><td style="text-align: right;">1</td><td style="text-align: left;">6</td></tr> </table>	5	9	1	6		
<table border="0" style="margin: 0 auto;"> <tr><td style="text-align: right;">9</td><td style="text-align: left;">5</td></tr> <tr><td style="text-align: right;">6</td><td style="text-align: left;">1</td></tr> </table>	9	5	6	1	<table border="0" style="margin: 0 auto;"> <tr><td style="text-align: right;">3 Tx</td><td style="text-align: left;">←</td><td style="text-align: right;">→</td><td style="text-align: left;">2 Rx</td></tr> <tr><td style="text-align: right;">2 Rx</td><td style="text-align: left;">←</td><td style="text-align: right;">→</td><td style="text-align: left;">3 Tx</td></tr> <tr><td style="text-align: right;">5 GND</td><td style="text-align: left;">←</td><td style="text-align: right;">→</td><td style="text-align: left;">5 GND</td></tr> </table>	3 Tx	←	→	2 Rx	2 Rx	←	→	3 Tx	5 GND	←	→	5 GND	<table border="0" style="margin: 0 auto;"> <tr><td style="text-align: right;">5</td><td style="text-align: left;">9</td></tr> <tr><td style="text-align: right;">1</td><td style="text-align: left;">6</td></tr> </table>	5	9	1	6					
9	5																										
6	1																										
3 Tx	←	→	2 Rx																								
2 Rx	←	→	3 Tx																								
5 GND	←	→	5 GND																								
5	9																										
1	6																										
Figure 19	UC-PRG015-02A (1.5 m) UC-PRG030-02A (3 m) UC-PRG050-02A (5M) (only for DOP)	USB Type-B ↔ USB Type-A																									
 <p>USB Type-B ← → USB Type-A</p> <table border="0" style="width: 100%; border-collapse: collapse;"> <tr> <td style="text-align: center; vertical-align: middle;"> <table border="0" style="margin: 0 auto;"> <tr><td style="text-align: right;">2</td><td style="text-align: left;">3</td></tr> <tr><td style="text-align: right;">1</td><td style="text-align: left;">4</td></tr> </table> </td> <td style="text-align: center; vertical-align: middle;"> <table border="0" style="margin: 0 auto;"> <tr><td style="text-align: right;">+5V (RED) 1</td><td style="text-align: left;">←</td><td style="text-align: right;">→</td><td style="text-align: left;">1 +5V (RED)</td></tr> <tr><td style="text-align: right;">D- (WHITE) 2</td><td style="text-align: left;">←</td><td style="text-align: right;">→</td><td style="text-align: left;">2 D- (WHITE)</td></tr> <tr><td style="text-align: right;">D+ (GREEN) 3</td><td style="text-align: left;">←</td><td style="text-align: right;">→</td><td style="text-align: left;">3 D+ (GREEN)</td></tr> <tr><td style="text-align: right;">GND (BLACK) 4</td><td style="text-align: left;">←</td><td style="text-align: right;">→</td><td style="text-align: left;">4 GND (BLACK)</td></tr> </table> </td> <td style="text-align: center; vertical-align: middle;"> <table border="0" style="margin: 0 auto;"> <tr><td style="text-align: right;">4</td><td style="text-align: left;">1</td></tr> </table> </td> </tr> </table>			<table border="0" style="margin: 0 auto;"> <tr><td style="text-align: right;">2</td><td style="text-align: left;">3</td></tr> <tr><td style="text-align: right;">1</td><td style="text-align: left;">4</td></tr> </table>	2	3	1	4	<table border="0" style="margin: 0 auto;"> <tr><td style="text-align: right;">+5V (RED) 1</td><td style="text-align: left;">←</td><td style="text-align: right;">→</td><td style="text-align: left;">1 +5V (RED)</td></tr> <tr><td style="text-align: right;">D- (WHITE) 2</td><td style="text-align: left;">←</td><td style="text-align: right;">→</td><td style="text-align: left;">2 D- (WHITE)</td></tr> <tr><td style="text-align: right;">D+ (GREEN) 3</td><td style="text-align: left;">←</td><td style="text-align: right;">→</td><td style="text-align: left;">3 D+ (GREEN)</td></tr> <tr><td style="text-align: right;">GND (BLACK) 4</td><td style="text-align: left;">←</td><td style="text-align: right;">→</td><td style="text-align: left;">4 GND (BLACK)</td></tr> </table>	+5V (RED) 1	←	→	1 +5V (RED)	D- (WHITE) 2	←	→	2 D- (WHITE)	D+ (GREEN) 3	←	→	3 D+ (GREEN)	GND (BLACK) 4	←	→	4 GND (BLACK)	<table border="0" style="margin: 0 auto;"> <tr><td style="text-align: right;">4</td><td style="text-align: left;">1</td></tr> </table>	4	1
<table border="0" style="margin: 0 auto;"> <tr><td style="text-align: right;">2</td><td style="text-align: left;">3</td></tr> <tr><td style="text-align: right;">1</td><td style="text-align: left;">4</td></tr> </table>	2	3	1	4	<table border="0" style="margin: 0 auto;"> <tr><td style="text-align: right;">+5V (RED) 1</td><td style="text-align: left;">←</td><td style="text-align: right;">→</td><td style="text-align: left;">1 +5V (RED)</td></tr> <tr><td style="text-align: right;">D- (WHITE) 2</td><td style="text-align: left;">←</td><td style="text-align: right;">→</td><td style="text-align: left;">2 D- (WHITE)</td></tr> <tr><td style="text-align: right;">D+ (GREEN) 3</td><td style="text-align: left;">←</td><td style="text-align: right;">→</td><td style="text-align: left;">3 D+ (GREEN)</td></tr> <tr><td style="text-align: right;">GND (BLACK) 4</td><td style="text-align: left;">←</td><td style="text-align: right;">→</td><td style="text-align: left;">4 GND (BLACK)</td></tr> </table>	+5V (RED) 1	←	→	1 +5V (RED)	D- (WHITE) 2	←	→	2 D- (WHITE)	D+ (GREEN) 3	←	→	3 D+ (GREEN)	GND (BLACK) 4	←	→	4 GND (BLACK)	<table border="0" style="margin: 0 auto;"> <tr><td style="text-align: right;">4</td><td style="text-align: left;">1</td></tr> </table>	4	1			
2	3																										
1	4																										
+5V (RED) 1	←	→	1 +5V (RED)																								
D- (WHITE) 2	←	→	2 D- (WHITE)																								
D+ (GREEN) 3	←	→	3 D+ (GREEN)																								
GND (BLACK) 4	←	→	4 GND (BLACK)																								
4	1																										
<p>◆ Note: UC-PRG050-02A is used for transferring input signals between the interface panel and the controller. The cable is used exclusively for all-electric injection molding machines.</p>																											

<p>Figure 20</p>	<p>AH10EN-5A</p>												
	 <p>1: Tx+ 2: Tx- 3: Rx+ 6: Rx-</p>												
<p>Figure 21</p>	<p>AH10SCM-5A</p>												
	<table border="1" data-bbox="1109 1176 1204 1400"> <tr><td>1</td><td>•</td></tr> <tr><td>2</td><td>•</td></tr> <tr><td>3</td><td>D+</td></tr> <tr><td>4</td><td>D-</td></tr> <tr><td>5</td><td>GND</td></tr> <tr><td>6</td><td>FG</td></tr> </table>	1	•	2	•	3	D+	4	D-	5	GND	6	FG
1	•												
2	•												
3	D+												
4	D-												
5	GND												
6	FG												
<p>Figure 22</p>	<p>AS-F232</p>												
	<p>2: Rx 3: Tx 5: GND</p>												

1

Figure 23	AS-F485
 A photograph of the AS-F485 connector, a grey plastic component with a green PCB on top and a multi-pin connector on the side.	<p>3: D+</p> <p>4: D-</p> <p>5: SG</p>