

# SRH1 Series Single Phase, Integrated Heatsink Type SSR

## Single Phase, Integrated Heatsink Type SSR

### ■ Features

- Superior dielectric strength: 4,000VAC
- Improved reliability by maximizing heat protection efficiency with heatsink integrated design and ceramic board
- Various mounting methods (DIN rail, screw fixing)
- Supports Zero cross turn-on/ Random turn-on type
- Checks input status by Input LED (green)



**⚠** Please read "Caution for your safety" in operation manual before using.



### ■ Ordering Information

**SRH 1 - 1 4 60 R**

Item	Control phase	1	Single phase
	Input voltage (rated)	2	24VAC
		4	90-240VAC
	Load voltage (rated)	2	24-240VAC
		4	48-480VAC
	Rated load current (resistive load)	15	15A
		20	20A
		30	30A
		40	40A
		60	60A
	Function	No Mark	Zero cross turn-on
		R	Random turn-on

Model	Input voltage	Rated load current	Load voltage	Zero cross turn-on/Random turn-on				
SRH1-1215	4-30VDC	15A	24-240VAC	Zero cross turn-on				
SRH1-2215	24VAC							
SRH1-4215	90-240VAC							
SRH1-1220	4-30VDC	20A						
SRH1-2220	24VAC							
SRH1-4220	90-240VAC							
SRH1-1230	4-30VDC	30A						
SRH1-2230	24VAC							
SRH1-4230	90-240VAC							
SRH1-1240	4-30VDC	40A						
SRH1-2240	24VAC							
SRH1-4240	90-240VAC							
SRH1-1260	4-30VDC	60A	48-480VAC	Zero cross turn-on				
SRH1-2260	24VAC							
SRH1-4260	90-240VAC							
SRH1-1420	4-30VDC	20A			48-480VAC	Zero cross turn-on		
SRH1-1420R	4-30VDC					Random turn-on		
SRH1-2420	24VAC					Zero cross turn-on		
SRH1-1430	4-30VDC	30A				48-480VAC	Zero cross turn-on	
SRH1-1430R	4-30VDC						Random turn-on	
SRH1-2430	24VAC						Zero cross turn-on	
SRH1-1460	4-30VDC	60A					48-480VAC	Zero cross turn-on
SRH1-1460R	4-30VDC							Random turn-on
SRH1-2460	24VAC							Zero cross turn-on

- (A) Photoelectric Sensors
- (B) Fiber Optic Sensors
- (C) Door/Area Sensors
- (D) Proximity Sensors
- (E) Pressure Sensors
- (F) Rotary Encoders
- (G) Connectors/ Sockets
- (H) Temperature Controllers
- (I) SSRs / Power Controllers
- (J) Counters
- (K) Timers
- (L) Panel Meters
- (M) Tacho / Speed / Pulse Meters
- (N) Display Units
- (O) Sensor Controllers
- (P) Switching Mode Power Supplies
- (Q) Stepper Motors & Drivers & Controllers
- (R) Graphic/ Logic Panels
- (S) Field Network Devices
- (T) Software

# SRH1 Series

## ■ Specifications

### ⊙ Input

4-30VDC input voltage	
Input voltage range	4-32VDC
Max. input current	9mA (Zero cross turn-on), 13mA (Random turn-on)
Pick-up voltage	4VDC
Drop-out voltage	1VDC
Turn-on time	Zero cross turn-on Max. 0.5 cycle of load source + 1ms Random turn-on Max. 1ms
Turn-off time	Max. 0.5 cycle of load source + 1ms
24VAC input voltage	
Input voltage range (50/60Hz)	19-30VACrms
Max. input current	12mArms (24VACrms)
Pick-up voltage	19VACrms
Drop-out voltage	4VACrms
Turn-on time	Max. 1.5 cycle of load source + 1ms
Turn-off time	Max. 1.5 cycle of load source + 1ms
90-240VAC input voltage	
Input voltage range (50/60Hz)	85-264VACrms
Max. input current	7mArms (240VACrms)
Pick-up voltage	85VACrms
Drop-out voltage	10VACrms
Turn-on time	Max. 1.5 cycle of load source + 1ms
Turn-off time	Max. 1.5 cycle of load source + 1ms

### ⊙ Output

24-240VAC load voltage						
Load voltage range (50/60Hz)		24-264VACrms				
Rated load current Ta=25°C	Resistive load (AC-51)	15Arms	20Arms	30Arms	40Arms	60Arms
Min. load current		0.15Arms	0.2Arms	0.2Arms	0.5Arms	0.5Arms
Max. 1 cycle surge current (60Hz)		190A	270A	330A	500A	1000A
Max. non-repetitive surge current (I <sup>2</sup> t, t=8.3ms)		150A <sup>2</sup> S	300A <sup>2</sup> S	500A <sup>2</sup> S	1000A <sup>2</sup> S	4000A <sup>2</sup> S
Peak voltage (Non-repetitive)		600V				
Leakage current (240VAC/60Hz, Ta=25°C)		Max. 10mArms				
Output ON voltage drop[Vpk] (Max. load current)		Max. 1.6V				
Static off state dv/dt		500V/μs				
48-480VAC load voltage						
Load voltage range (50/60Hz)		48-528VACrms				
Rated load current Ta=25°C	Resistive load (AC-51)	20Arms		30Arms		60Arms
	Motor load (AC-53a)	5Arms		8Arms		15Arms
Min. load current		0.5Arms		0.5Arms		0.5Arms
Max. 1 cycle surge current (60Hz)		300A		500A		1000A
Max. non-repetitive surge current (I <sup>2</sup> t, t=8.3ms)		350A <sup>2</sup> S		1000A <sup>2</sup> S		4000A <sup>2</sup> S
Peak voltage (Non-repetitive)		1200V (Zero cross turn-on), 1000V (Random turn-on)				
Leakage current (480VAC/60Hz, Ta=25°C)		Max. 10mArms				
Output ON voltage drop[Vpk] (Max. load current)		Max. 1.6V				
Static off state dv/dt		500V/μs				

# Single Phase, Integrated Heatsink Type SSR

## ■ Specifications

### ○ General Specifications

Certification	UL508, CSA22.2 NO. 14 and IEC/EN 60947-4-3	
Dielectric strength (Vrms)	400VAC 50/60Hz for 1 min. (Input-Output, I/O-Case)	
Insulation resistance	Min. 100MΩ (500VDC megger)	
Vibration	10 to 55Hz double amplitude 0.75mm in each X, Y, Z direction for 1 hour	
Input LED	Green	
Environ-ment	Ambient temperature	-30 to 80°C, storage: -30 to 100°C (Rated load current capacity is different based on the surrounding temperature. Refer to '■ SSR Characteristic Curve'.)
	Ambient humidity	45 to 85%RH, storage: 45 to 85%RH
Input terminal connection	Min. 1×0.5mm <sup>2</sup> (1×AWG 20) Max. 1×1.5mm <sup>2</sup> (1×AWG 16) or 2×1.5mm <sup>2</sup> (2×AWG 16)	
Output terminal connection	<ul style="list-style-type: none"> <li>Case width 22.5mm (M4 terminal bolt): Min. 1×0.75mm<sup>2</sup> (1×AWG18) Max. 1×4mm<sup>2</sup> (1×AWG12) or 2×2.5mm<sup>2</sup> (2×AWG14)</li> <li>Case width 45mm (M5 terminal bolt): Min. 1×1.5mm<sup>2</sup> (1×AWG16) Max. 1×16mm<sup>2</sup> (1×AWG6) or 2×6mm<sup>2</sup> (2×AWG10)</li> </ul> ※Use wires compliant with load current capacity to connect to the terminal.	
Input terminal fixed torque	0.75 to 0.95N·m	
Output terminal fixed torque	• Case width 22.5mm (M4 terminal bolt): 15A/20A: 1 to 1.35N·m	
	• Case width 45mm (M5 terminal bolt): 30A/40A/60A: 1.6 to 2.2N·m	
Unit weight	• Rated load current (Resistive load) 15A/20A: Approx. 225g	
	• Rated load current (Resistive load) 30A/40A: Approx. 410g	
	• Rated load current (Resistive load) 60A: Approx. 680g	

※For wiring the terminal, an O-ring terminal must be used.

※Environment resistance is rated at no freezing or condensation.

## ■ Dimensions & Mounting

### ○ Dimensions

#### ● 15A/20A rated load current

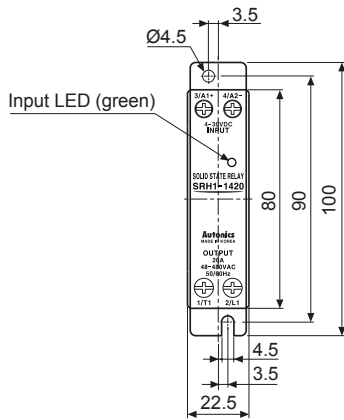

#### ● 30A/40A rated load current

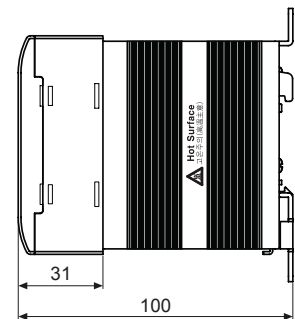
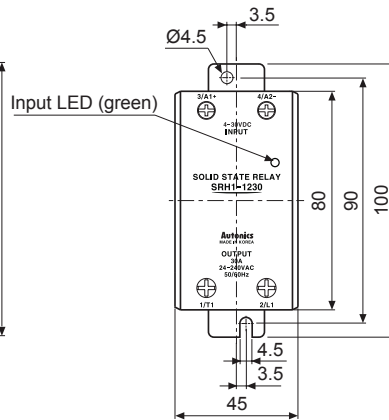

#### ● 60A rated load current

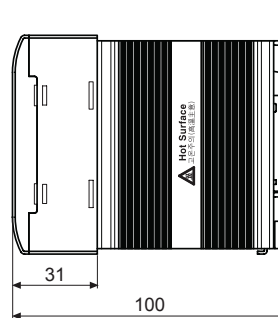
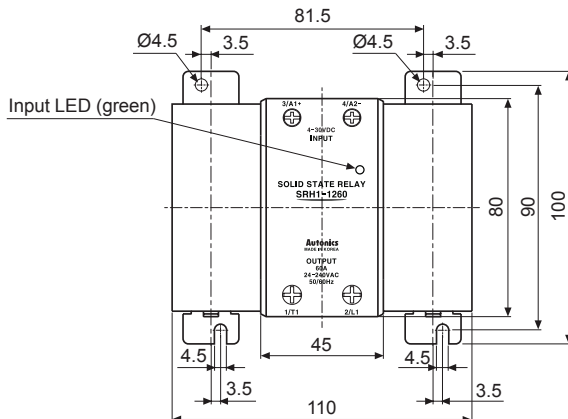

(unit: mm)

(A) Photoelectric Sensors

(B) Fiber Optic Sensors

(C) Door/Area Sensors

(D) Proximity Sensors

(E) Pressure Sensors

(F) Rotary Encoders

(G) Connectors/ Sockets

(H) Temperature Controllers

(I) SSRs / Power Controllers

(J) Counters

(K) Timers

(L) Panel Meters

(M) Tacho / Speed / Pulse Meters

(N) Display Units

(O) Sensor Controllers

(P) Switching Mode Power Supplies

(Q) Stepper Motors & Drivers & Controllers

(R) Graphic/ Logic Panels

(S) Field Network Devices

(T) Software

# SRH1 Series

(unit: mm)

- Hole cut-out for panel front mounting
  - 15A/20A/30A/40A rated load current
  - 60A rated load current

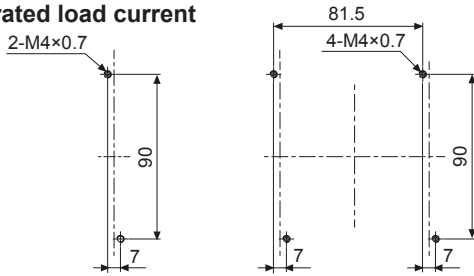

※ Tightening torque for mounting: 1.8 to 2.5N·m

- DIN rail mounting
  - DIN rail attachment

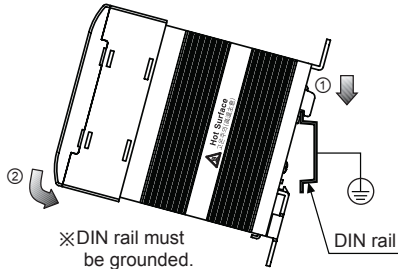

- DIN rail detachment

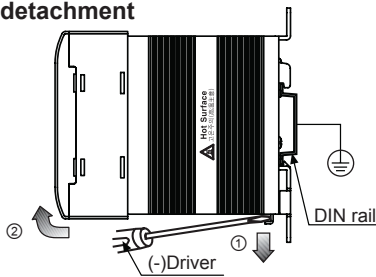

- Installation interval

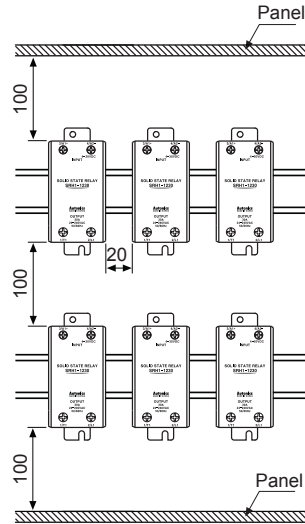

※ For mounting multiple SSRs, please keep certain installation intervals for heat prevention.  
For horizontal installation (when the heights of input part and output part are equal), it is recommended to apply 50% of rated load current.

**High temperature caution**  
Make sure do not touch the heat sink or the unit body while power is supplied or right after load power is turned off. If not, it may cause a burn.

## Connections

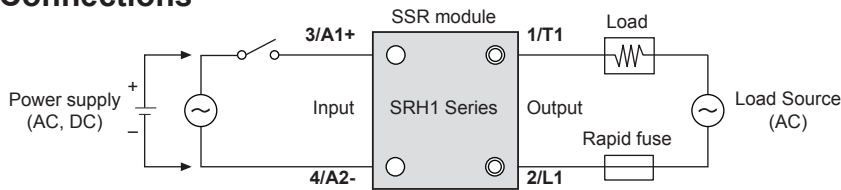

## SSR Characteristic Curve

- SRH1-1215/2215/4215

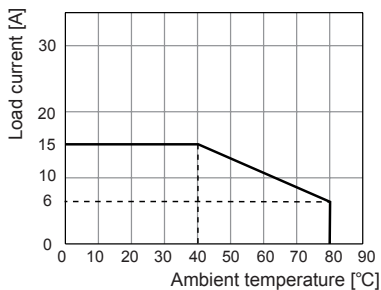

- SRH1-1220/2220/4220  
SRH1-1420/1420R/2420

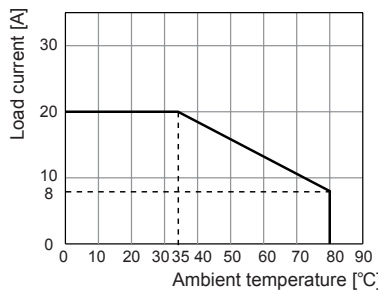

- SRH1-1230/2230/4230

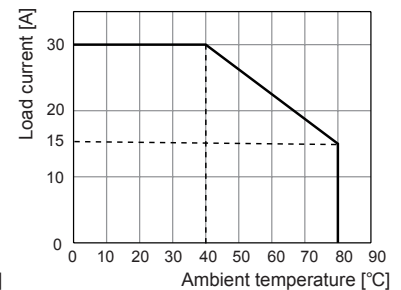

# Single Phase, Integrated Heatsink Type SSR

## ■ SSR Characteristic Curve

○ SRH1-1430/1430R/2430

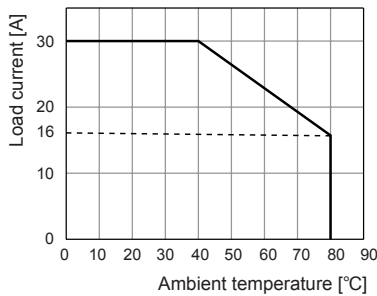

○ SRH1-1240/2240/4240

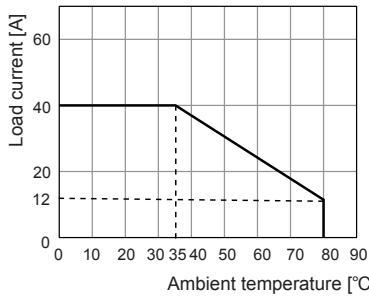

○ SRH1-1260/1460/1460R  
SRH1-2460/2260/4260

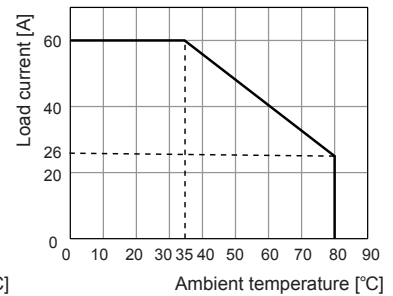

## ■ Proper Usage

### ⚠ High temperature caution

Make sure do not touch the heat sink or the unit body while power is supplied or right after load power is turned off. If not, it may cause a burn.

### ⚠ Caution for using

1. Attach a heatsink and ventilate for smooth convection current. If not, congested heat transfer may cause product failure or malfunction.
2. For mounting multiple SSR, please keep certain installation intervals for heat prevention. For horizontal installation (when the heights of input part and output part are equal), it is recommended to apply less than 50% of the rated load current.
3. Make sure do not touch the heatsink or the unit body while power is supplied or right after load power is turned OFF. If not, it may cause a burn.
4. Connect the proper cable for the rated load current with output terminal.
5. Use rapid fuse of which  $I^2t$  is under 1/2 of SSR  $I^2t$  in order to protect the unit from load's short-circuit current.
6. In case of a short-circuit please replace the fuse with a 1/2 of SSR  $I^2t$  value specified semiconductor protective type.
7. In case that load's current is lower than SSR min. load current, connect dummy resistance to the load in parallel so as to make load's current higher than SSR min. load current.
8. When selecting phase control with random turn-on model, install the noise filter between load and load's source.
9. Make sure that the screw on output terminal is tightly fastened. Using the unit with loose bolt may cause product failure or malfunction.
10. Do not touch the load's terminal even if output is OFF. It may cause electric shock.
11. The signal input of the 4-30VDC model should be supplied by the insulated and limited voltage/current or by Class 2 power supply.
12. Proper application environment (Avoid following environments to install)
  - ① Where temperature/humidity is beyond the specification
  - ② Where dew condensation occurs due to temperature change
  - ③ Where inflammable or corrosive gas exists
  - ④ Where direct rays of light exist
  - ⑤ Where severe shock, vibration or dust exists
  - ⑥ Where near facilities generating strong magnetic forces or electric noise
13. This product may be used in the following environments.
  - ① Indoor
  - ② Altitude: Under 2,000m
  - ③ Pollution degree 2
  - ④ Installation category III

(A)

Photoelectric Sensors

(B)

Fiber Optic Sensors

(C)

Door/Area Sensors

(D)

Proximity Sensors

(E)

Pressure Sensors

(F)

Rotary Encoders

(G)

Connectors/ Sockets

(H)

Temperature Controllers

(I)

SSRs / Power Controllers

(J)

Counters

(K)

Timers

(L)

Panel Meters

(M)

Tacho / Speed / Pulse Meters

(N)

Display Units

(O)

Sensor Controllers

(P)

Switching Mode Power Supplies

(Q)

Stepper Motors & Drivers & Controllers

(R)

Graphic/ Logic Panels

(S)

Field Network Devices

(T)

Software