

KN-1000B Series

Features

- High accuracy with 16bit ADC ($\pm 0.2\%$ F.S.)
- Multi-input
 - : Thermometer 12 types, RTD 5 types, analog (mV, V, mA) 6 types
- Bar graph with 101 LEDs (green), 4digit display (red)
- Various output options
 - : 4EA or 2EA alarm output, 4-20 mA transmission output (isolated), RS485 communication output
- Various functions
 - : High/Low peak monitoring, sensor break alarm output (burn-out), input correction, digital input (DI), user input range, display scale, transmission output scale, bar graph alarm display, etc.
- Built-in power supply for sensor (24VDC)
- Compact size (rear length: 70 mm)



! Please read "Caution for your safety" in operation manual before using this unit.

Ordering information

KN - 1 0 0 0 B

Size	B	DIN W36×H144 mm
Power supply	0	100-240 VAC 50 to 60 Hz
	1	24 VDC
Option output	0	No option
	1	Transmission output (4-20 mA)
	4	RS485 communication output
Alarm output	0	No alarm output
	2	2EA alarm output
	4	4EA alarm output
Item	KN-1	Bar Graph Indicator

Dimensions

(unit:mm)

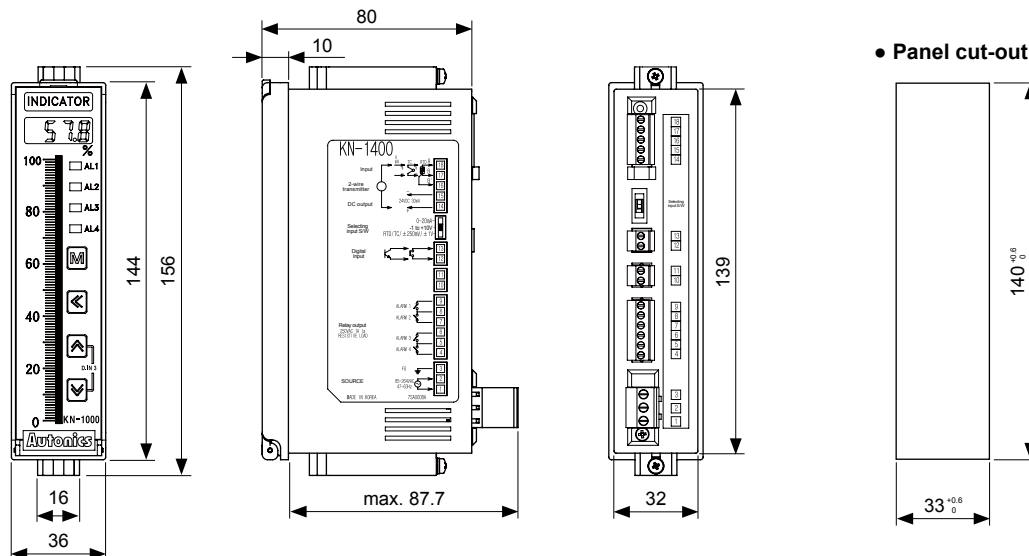

Bar Graph Digital Indicator

Connections

• KN-10□□B

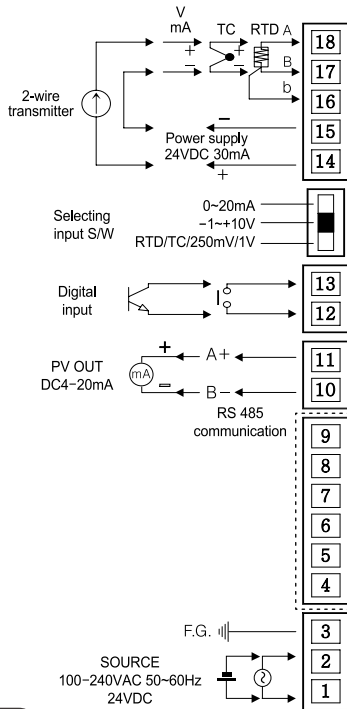

• KN-12□□B

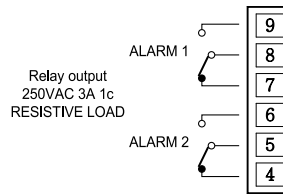

• KN-14□□B

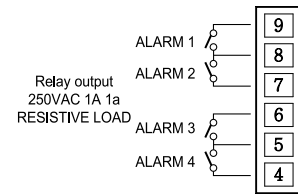

Specifications

Series	KN-1000B	
Power supply	AC voltage	100-240 VAC 50 to 60 Hz
	DC voltage	24 VDC
Allowable voltage range	90 to 110% of rated voltage	
Power consumption	AC voltage	Max. 6 VA
	DC voltage	Max. 4 W
Display method	4digit: 7Segment LED Display (red), Bar LED: 101EA (green)	
Input type	RTD	JPt100Ω, DPt100Ω, DPt50Ω, Cu50Ω, Cu100Ω (5 types)
	Thermocouple	K, J, E, T, R, B, S, N, C (W5), L, U, PLII (12 types)
	Analog	· Voltage: ±1.000 V, ±50.00 mV, -199.9-200.0 mV, -1.00 V-10.00 V (4 types) · Current: 4.00-20.00 mA, 0.00-20.00 mA (2 types)
Digital input	· Contact input: Max. 2 kΩ in ON, Max. 90 kΩ in OFF · Non-contact input: Residual voltage max. 1.0 V in ON, Leakage current max. 0.03 mA in OFF · Outflow current: Approx. 0.2mA	
Sub output	Alarm output	2-point: Relay contact capacity 250 VAC 3 A 1c, 4-point: Relay contact capacity 250 VAC 1 A 1a
	Transmission output	ISOLATED DC 4-20 mA(PV transmission) load resistance max. 600 Ω (accuracy: ±0.2%F.S., resolution: 8000)
	Communication output	RS485 (Modbus RTU)
Display accuracy	±0.2% F.S. ±1digit (25 °C±5 °C) ±0.3% F.S. ±1digit (-10 °C to 20 °C, 30 °C to 50 °C) In case of thermocouple and below -100 °C input, [±0.4%F.S.] ±1digit ※ TC-T, TC-U is min. ±2.0 °C	
Setting method	Set by front keys, or RS485 communication	
Alarm output hysteresis	Set ON/OFF interval (1 to 999 digit)	
Sampling cycle	Analog input: 100 ms, Temperature sensor input: 250 ms	
Dielectric voltage	2000 VAC 50/60 Hz for 1 min. (between input terminal and power terminal)	
Vibration	0.75 mm amplitude at frequency of 5 to 55 Hz (for 1 min.) in each of X, Y, Z directions for 2 hours	
Relay life cycle	2-point	Mechanical: Min. 10,000,000, Electrical: Min. 100,000 (250 VAC 3 A resistance load)
	4-point	Mechanical: Min. 20,000,000, Electrical: Min. 500,000 (250 VAC 1 A resistance load)
Insulation resistance	Min. 100 MΩ (at 500VDC megger)	
Noise resistance	Square shaped noise by noise simulator (pulse width 1 μs) ±2 kV	
Memory retention	Approx. 10 years (non-volatile semiconductor memory type)	
Environment	Ambient temperature	-10 to 50 °C, storage: -20 to 60 °C
	Ambient humidity	35 to 85%RH, storage: 35 to 85%RH
Approval	CE	
Unit weight	Approx. 200 g	

※ Environment resistance is rated at no freezing or condensation.

A. Recorder

B. Indicator

C. Converter

D. Controller

E. Thyristor unit

F. Pressure transmitter

G. Temp. transmitter

H. Accessories

KN-1000B

KN-2000W

KN-1000B Series

Input type and range

◎ Input type selection switch

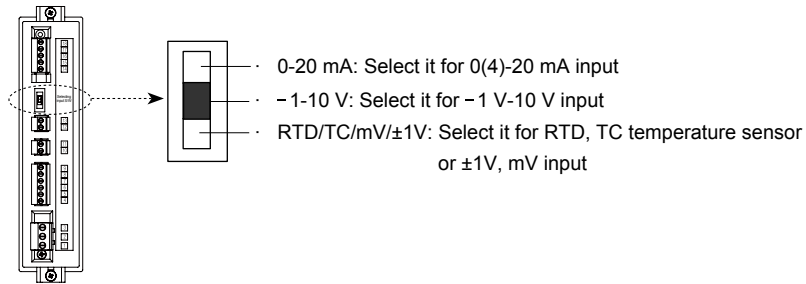

This unit is multi input product. Select the proper input with the input type selection switch and select this input type in $i n - P$ in program mode. The setting of input type selection switch and the input type $i n - P$ parameter should be same and it can display the proper measurement value. Factory default is 0-20 mA.

Input type		Parameter	Input range(°C)	Input range(°F)
Thermocouple	K(CA)	$t C E 1$	-200 to 1350	-328 to 2462
	K(CA)	$t C E 2$	-199.9 to 999.9	-328 to 1832
	J(IC)	$t C - J$	-199.9 to 800.0	-328 to 1472
	E(CR)	$t C - E$	-199.9 to 800.0	-328 to 1472
	T(CC)	$t C - t$	-199.9 to 400.0	-199.9 to 752.0
	B(PR)*	$t C - b$	100 to 1800	212 to 3272
	R(PR)	$t C - r$	0 to 1750	32 to 3182
	S(PR)*	$t C - S$	0 to 1750	32 to 3182
	N(NN)*	$t C - n$	-200 to 1300	-328 to 2372
	C(W5)*	$t C - C$	0 to 2300	32 to 4172
	L(IC)*	$t C - L$	-199.9 to 900.0	-328 to 1652
	U(CC)*	$t C - U$	-199.9 to 400.0	-199.9 to 752.0
	Platinel II*	$t C - P$	0 to 1390	32 to 2534
RTD	Cu50Ω*	$C U 5 0$	-199.9 to 200.0	-199.9 to 392.0
	Cu100Ω*	$C U 1 0$	-199.9 to 200.0	-199.9 to 392.0
	JPt100Ω	$J P t . 1$	-199.9 to 600.0	-328 to 1112
	DPt50Ω	$d P t . 5$	-199.9 to 600.0	-328 to 1112
	DPt100Ω	$d P t . 1$	-199.9 to 850.0	-328 to 1530
Analog	Current	0.00 - 20.00 mA	$R . n R 1$	-1999 to 9999 (display range depends on the decimal point position)
		4.00 - 20.00 mA	$R . n R 2$	
	Voltage	-50.0 - 50.0 mV	$R . n u 1$	
		-199.9 - 200.0 mV	$R . n u 2$	
		-1.000 - 1.000 V	$R - u 1$	
		-1.00 - 10.00 V	$R - u 2$	

※ Above input types which have the * mark are not displayed.
 To display the above input types, supply the power with pressing the \boxed{M} key.

Part descriptions

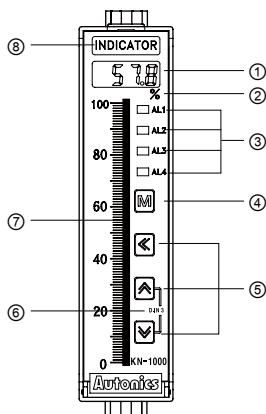

- ① Display part(red)
 - Run mode: Displays current measurement value.
 - Parameter set mode: Displays parameter and SV.
- ② Unit sticker part(unit sticker is an accessory.)
- ③ Alarm output indicator: Turns ON when the alarm is ON.
- ④ \boxed{M} key: Used to enter parameter set mode, move to parameters, save SV and return to RUN mode.
- ⑤ $\boxed{\leftarrow}$, $\boxed{\rightarrow}$, $\boxed{\text{ON}}$ key: Used to enter and change parameter SV.
- ⑥ D.IN3: Press the $\boxed{\leftarrow}$ and $\boxed{\rightarrow}$ keys for 3 sec. at the same time, it operates the set function (alarm clear, display hold, zero-point adjustment) at $d i - E$ at program mode.
- ⑦ Bar Graph (with 101 bar LEDs, green): Displays measured value as bar graph.
- ⑧ Space for recognition device by user

Bar Graph Digital Indicator

Functions

Alarm [AL-1, AL-2, AL-3, AL-4]

This product has 2 or 4 alarms to operate individually when the value is too high or low. Alarm function is set by the combination of alarm operation and alarm option. To clear alarm, use digital input function (setting $di-1, di-2$ as $RLRE$) or turn the power OFF and ON.

※ For the model (KN-10□□B) without alarm output, these parameters are not displayed.

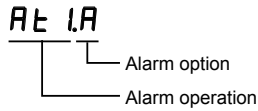

Alarm operation

Mode	Name	Alarm operation	Descriptions
AL 0	—	—	No alarm operation
AL 1	High limit alarm		PV ≥ alarm temperature, alarm is ON
AL 2	Low limit alarm		PV ≤ alarm temperature, alarm is ON
Sb AL	Sensor break alarm	—	It will be ON when it detects sensor disconnection. Sensor break alarm does not have alarm option.

※ H: Alarm output hysteresis

Alarm option

Mode	Name	Descriptions
AL a	Standard alarm	If it is an alarm condition, alarm output is ON. Unless an alarm condition, alarm output is OFF.
AL b	Alarm latch	If it is an alarm condition, alarm output is ON. Before clearing the alarm, an ON condition is latched. (Holding the alarm output)
AL c	Standby sequence	First alarm condition is ignored. From the second alarm condition, standard alarm operates. When power is ON and it is an alarm condition, it is ignored. From the second alarm condition, standard alarm operates.
AL d	Alarm latch and standby sequence	If it is an alarm condition, it operates both alarm latch and standby sequence. When power is ON and it is an alarm condition, it is ignored. From the second alarm condition, alarm latch operates.

Alarm output hysteresis [Program mode: R-HY]

Set the interval of ON/OFF alarm output. The set hysteresis is applied to AL1 to AL4 and it is as below.

※Ex) R-HY: 4, high limit alarm value: 800, low limit alarm value: 200

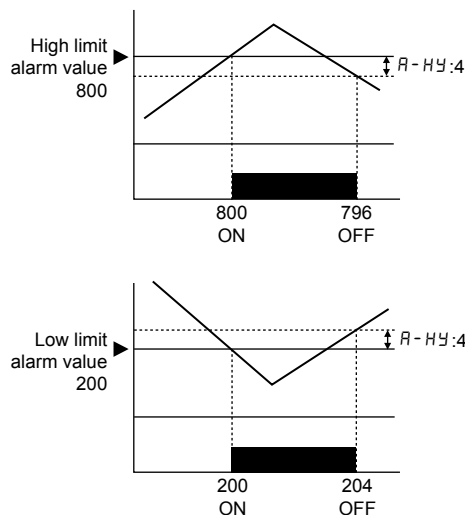

High/Low peak monitoring [Monitoring mode: H.PEE, L.PEE]

This function is to save high/low peak to check the invisible abnormal condition of system at [H.PEE] or [L.PEE] in monitoring mode.

When the high/low peak is out of the temperature range, it displays HHHH or LLLL.

To initialize high/low peak, press the and keys at the same time for 3 sec. at [H.PEE] or [L.PEE].

In this case, peak value is the present input value.

Error

Display	Descriptions	Troubleshooting
LLLL	Flashes when measured sensor input is lower than the temperature range.	When input is moved within the temperature range, it is cleared.
HHHH	Flashes when measured sensor input is higher than the temperature range	
bUrn	Flashes when the sensor is break or not connected.	Check temperature sensor connection.
Err	Flashes when there is error to SV	Check set conditions and re-set it.

A. Recorder

B. Indicator

C. Converter

D. Controller

E. Thyristor unit

F. Pressure transmitter

G. Temp. transmitter

H. Accessories

KN-1000B

KN-2000W

Parameter initialization

To initialize all parameter as factory default, supply the power to the product with pressing the **[M]** and **[⏏]** keys at the same time and it enters initialization parameter.

Press the **[M]** + **[⏏]** keys at the same time.

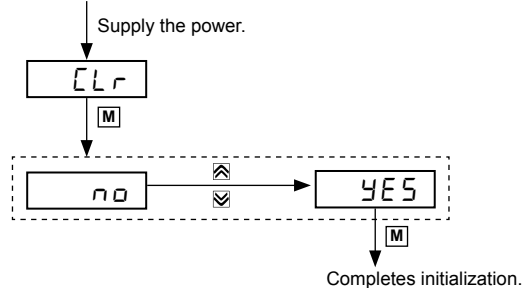

Temperature unit [Program mode: $U_{n1} t$]

Temperature unit ($^{\circ}C/^{\circ}F$) is selectable. When changing temperature unit, user input range, display scale, output scale, alarm SV are initialized. You should set the parameters again for your purpose.

※ When selecting analog input, temperature unit [$U_{n1} t$] parameter is not displayed.

User input range [Program mode: $L-rG, H-rG$]

When selecting analog input, you can set the input range for your purpose. Set low limit input value [$L-rG$] and high limit input value [$H-rG$] to limit the input range.

• Set conditions:

- Low limit input value [$L-rG$] +20%F.S.
- < High limit input value [$H-rG$]

Decimal point [Program mode: dP]

It is able to change decimal point position for high/low limit scale value. It changes decimal point position of display value.

Transmission output scale [Program mode: L_{oUt}, H_{oUt}]

For 4-20 mA current output, this function is to set the display value for 4 mA [L_{oUt}] and the display value for 20 mA [H_{oUt}].

The interval between L_{oUt} and H_{oUt} is 10% F.S. If it is below 10%, it is fixed as 10% of SV.

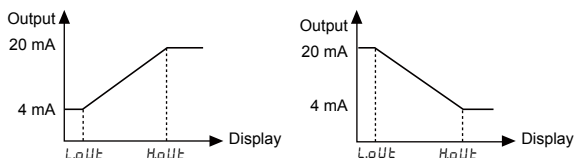

Display scale [Program mode: $L-5C, H-5C$]

For analog input, this function is to set (-1999 to 9999) for particular high/low limit value in order to display high/low limit value of measurement input. If measurement inputs are 'a' and 'b' and particular values are 'A' and 'B', it will display $a=A, b=B$ as below graphs.

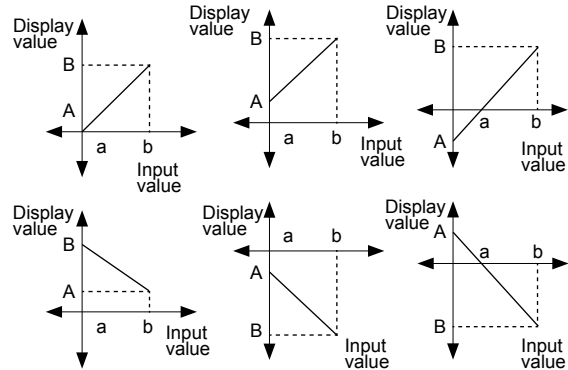

Display scale function is able to change display value for max./min. measured input by setting high limit scale [$H-5C$] and low limit scale [$L-5C$] in program mode.

※Ex) Set high/low scale value (input range is 0 to 10V)

- $L-5C = 0.00$
- $H-5C = 5.00, 10.00, 15.00, 10.00$

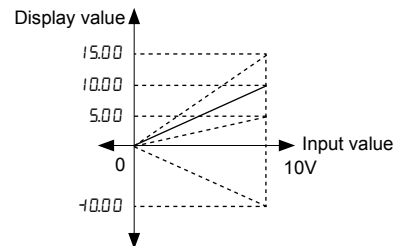

- $L-5C = 10.00, H-5C = 10.00$

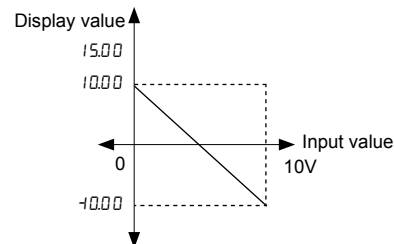

- $L-5C = -5.00, H-5C = 5.00$

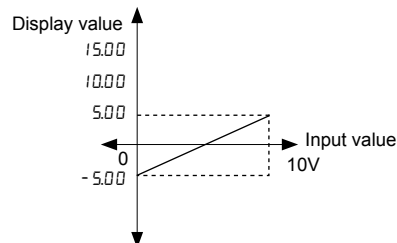

※When changing input type, high/low scale is changed as factory default.

Bar Graph Digital Indicator

■ Bar graph scale [Program mode: $L-b5, H-b5$]

This is to set display range for bar graph. Display range is as below.

Parameter	Input	Display range
$L-b5$	Temp. sensor input	Input range (low limit) $\leq L-b5 \leq (H-b5-1)$
	Analog input	$L-5C \leq L-b5 \leq (H-5C-1)$
$H-b5$	Temp. sensor input	$(L-b5+1) \leq H-b5 \leq$ Input range (high limit)
	Analog input	$(L-5C+1) \leq H-b5 \leq H-5C$

※ Relation among input range, user input range, display scale, bar graph scale, and transmission scale

The below figure is the example for 4 to 20 mA.

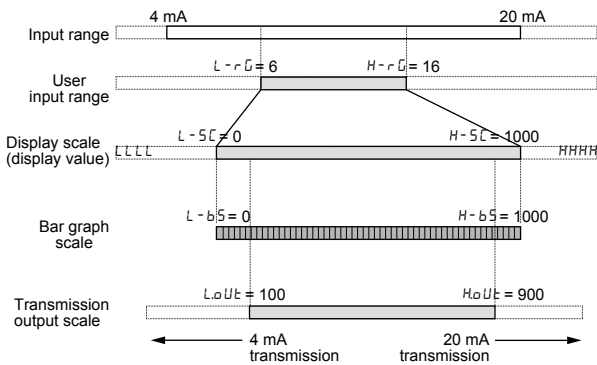

■ Bar graph display method [Program mode: bAr]

There are two methods for bar graph display; full bar and center bar.

Full bar [$F.bAr$] displays input from the bottom, and center bar method [$C.bAr$] displays input from "0" as below figures.

※ Ex) When $L-b5 = -100, H-b5 = 100, PV = -50$,

◎ Full Bar: $F.bAr$

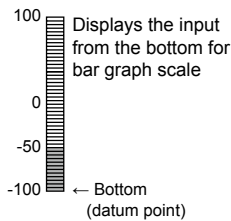

◎ Center Bar: $C.bAr$

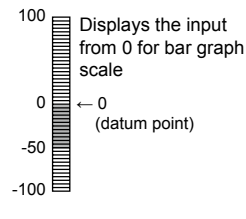

■ Alarm display in bar graph

When setting or occurring the alarm, it displays the status by the bar graph.

You can check the alarm status. When setting alarm value, the bar LED for this alarm value turns ON. When alarm occurs, the bar LED for this alarm value flashes.

① When setting alarm value,

The bar LED for alarm SV flashes. When alarm set is complete, the bar LED for this alarm value turns ON.

② RUN mode

- All set alarm values are displays in RUN mode.
- When it is alarm value, the bar LED for this alarm value flashes.

※ If alarm set value is out of bar graph scale when setting the value or in RUN mode, this value does not display in bar graph.

◎ When setting alarm value in monitoring mode,

When all alarms are OFF,

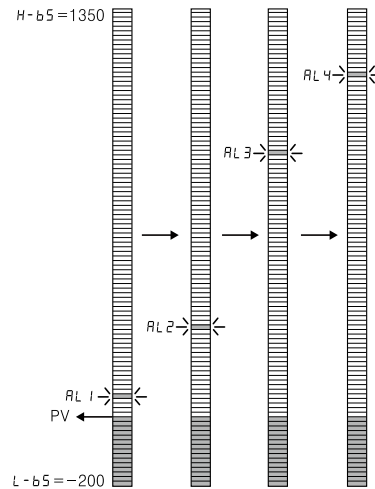

※ The bar LED for the alarm value flashes.

◎ Alarm display in RUN mode

When $AL1$ and $AL2$ are low limit alarm, and $AL3$ and $AL4$ are high limit alarm.

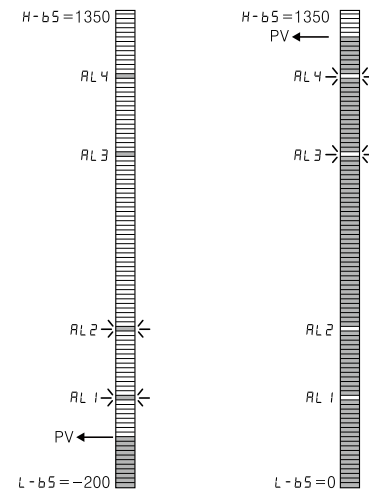

■ Input and transmission output extension [Program mode: $E4o$]

This function is to extend analog input and 4 to 20 mA transmission output to 5% or 10% range.

Mode	Operation
$0P$	Outputs 4 to 20 mA within analog input range.
$5P$	Outputs 3.2 to 20.8 mA for 5% out of the analog input range.
$10P$	Outputs 2.4 to 21.6 mA for 10% out of the analog input range.

※ This parameter is displayed only for transmission output (4-20 mA) model. But it is not displayed when selecting temperature sensor input.

※ The below of 0 mA, 0 V cannot be extended.

※ ± 1 V, 10 V inputs are only available for 5% extension.

- A. Recorder
- B. Indicator
- C. Converter
- D. Controller
- E. Thyristor unit
- F. Pressure transmitter
- G. Temp. transmitter
- H. Accessories

- KN-100B
- KN-200W

KN-1000B Series

Input special function [Program mode: I nSF]

When selecting analog input, this function is to display the calculated actual value by square, root ($\sqrt{\quad}$), or two unit function (TUF) as display value.

Parameter	Functions	Graph	Applications
Line	Outputs as input value		Standard characteristics. Input for linearity.
Root	Outputs the rooted ($\sqrt{\quad}$) input value		Used for measuring flows by pressure signal.
Square	Outputs the squared input value		Used for outputting differential pressure by flow signal.
TUF	Refer to 'Two unit function'		

※ Display value and mA output value for Square :

$$\text{Display value} = \left(\frac{\text{Input value} - L - rG}{H - rG - L - rG} \right)^2 \times (H - 5C - L - 5C) + L - 5C$$

(output value)

※ Display value and mA output value for Root :

$$\text{Display value} = \left(\sqrt{\frac{\text{Input value} - L - rG}{H - rG - L - rG}} \right) \times (H - 5C - L - 5C) + L - 5C$$

(output value)

Two Unit Function [Program mode: LUF]

When connecting a pressure sensor, compound pressure which is below atmospheric pressure (0) is for vacuum as mmHg and which is atmospheric pressure or over it is for positive pressure as kg/cm².

Atmospheric pressure is 0 kg/cm². When this unit does not display 0 kg/cm², you can correct zero-point adjustment function.

When using two unit function, L - 5C is fixed as -760.

L - 5C parameter is displayed but you cannot set this. You can set H - 5C within 0 to 9999 range.

Ex) When pressure range is -760.0 mmHg to 3.000 kg/cm², and pressure transmitter outputs 4-20 mA, set the scale as H - 5C : 3000, dP : 0.000. This unit displays for 4 mA input as -760, and for 20 mA input as 3.000.

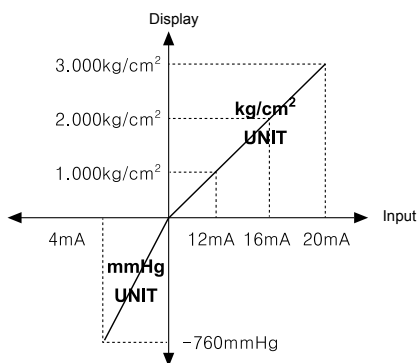

Input correction [Program mode: I n-b]

This function is to correct the error occurring from a thermocouple, a RTD or analog input out of allowable error range of this unit.

This is also available to correct error when a sensor cannot contact the subject position by calculating the error temperature.

Variable temperature sensors have accuracy level. Because high accuracy type is expensive, standard thermocouples are generally used.

In this case, temperature sensor may occur error. By executing this function, you can get more accurate temperature.

When executing input correction function, you should measure the error from a sensor accurately. If the measured error is not correct, error may be greater. (If I nSF = LUF, I n-b as atmospheric pressure input value not as input correction function. Refer to Two unit function.)

Ex) When measured temperature is 4 °C and actual temperature is 0 °C. Set I n-b as -4, and display value is 0 °C.

Digital filter [Program mode: nRdF]

Moving average digital filter is able to stably display and output the noise from input line and irregular signals as software.

• Filter set range: 01 to 16

(When setting as 01, digital filter function does not run.)

※ Display cycle is same when executing moving average digital filter.

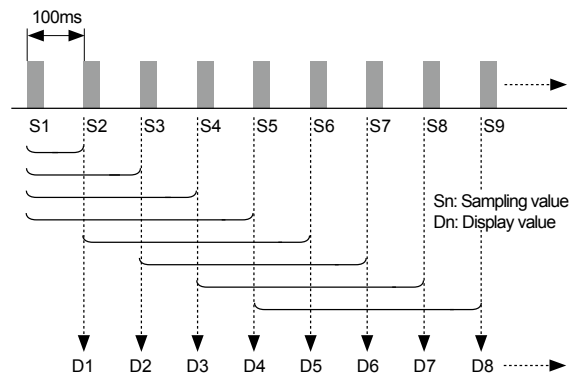

D1=S1, D2=S2, D3=S3

: Initial operation before averaging 4

$$D4 = \frac{S1+S2+S3+S4}{4}$$

$$D5 = \frac{S2+S3+S4+S5}{4}$$

$$D6 = \frac{S3+S4+S5+S6}{4}$$

$$D7 = \frac{S4+S5+S6+S7}{4}$$

$$D8 = \frac{S5+S6+S7+S8}{4}$$

Bar Graph Digital Indicator

■ Burn Out [Program mode: *bUrN*]

When disconnecting input sensor, you can set the status of transmission output.

- When setting *bUrN* as *oN*,
4-20 mA transmission output is fixed as 20 mA.
- When setting *bUrN* as *oFF*,
4-20 mA transmission output is fixed as 4 mA.

※ It is available only for temperature sensor input and 4-20 mA transmission output.

■ Digital input [Program mode: *dI - t*, *dI - t*]

By digital input terminal [*dI - t*] (no. 12, 13 terminals) or digital input key [*dI - t*] (D.IN3: ☒ + ☒ for 3 sec.), one of three functions executes as the below table.

Function	Operaiton
<i>ALrE</i> Alarm clear	When alarm is ON in RUN mode, it clears alarm forcibly. (It applies only for alarm latch, alarm latch and standby sequence options.) Alarm clear operates only when the value is out of the alarm value range. After clearing alarm, alarm operates its option normally. ※ For the model without alarm output (KN-10□□B), this parameter is not displayed.
<i>HoLd</i> Display HOLD	Temporarily indicated value is stopped in order to check indicated value in unstable input.
<i>≡ErO</i> Zero-point adjustment	Set preset display value as 0. This function is related with input correction [<i>i n - b</i>]. When executing zero adjustment function in display value as 4, input correction value [<i>i n - b</i>] is set as -4 automatically.

■ Lock [Program mode: *LoCk*]

It limits to check parameter set value and to change it.

	<i>oFF</i>	<i>LoCk</i>	<i>LoCk</i>
Program mode	●	◐	○
Monitoring mode	●	●	◐

- : Enable to check/set,
- ◐ : Enable to check, disable to set,
- : Disable to check

※ In *LoCk*, only *LoCk* parameter displays in program mode.

Communications

■ Communication set [Program mode: *Addr*, *bRUD*]

You can set communication address [*Addr*] and communication speed [*bRUD*] for RS485 communication.

■ Communication specifications

Item	Specifications
Communication method	RS485 2-wire half duplex
Communication speed (BPS)	9600, 4800, 2400, 1200
Converter	Converter built in RS232
Max. connections	32 units
Communication distance	Max. 1200m (within 700 m recommended)
Protocol	MODBUS 1.1 RTU
Parity	None
Stop Bit	1Bit
Data length	8Bit

■ Communication manual

Refer to communication manual for RS485 communication. Visit our web site (www.autonics.com) to download communication manual and software [Integrated device management program: DAQMaster].

■ Integrated device management program (DAQMaster)

DAQMaster is the integrated device management program to set parameters and manage monitoring data.

Visit our website (www.autonics.com) to download user manual and integrated device management program.

< Computer specification for using software >

Item	Minimum requirements
System	IBM PC compatible computer with Intel Pentium III or above
Operating system	Microsoft Windows 98/NT/XP/Vista/7
Memory	256MB or more
Hard disk	More than 1GB of free hard disk space
VGA	1024×768 or higher resolution display
Others	RS-232 serial port(9-pin), USB port

< DAQMaster screen >



- A. Recorder
- B. Indicator
- C. Converter
- D. Controller
- E. Thyristor unit
- F. Pressure transmitter
- G. Temp. transmitter
- H. Accessories

KN-1000B

KN-2000W

KN-1000B Series

Monitoring mode

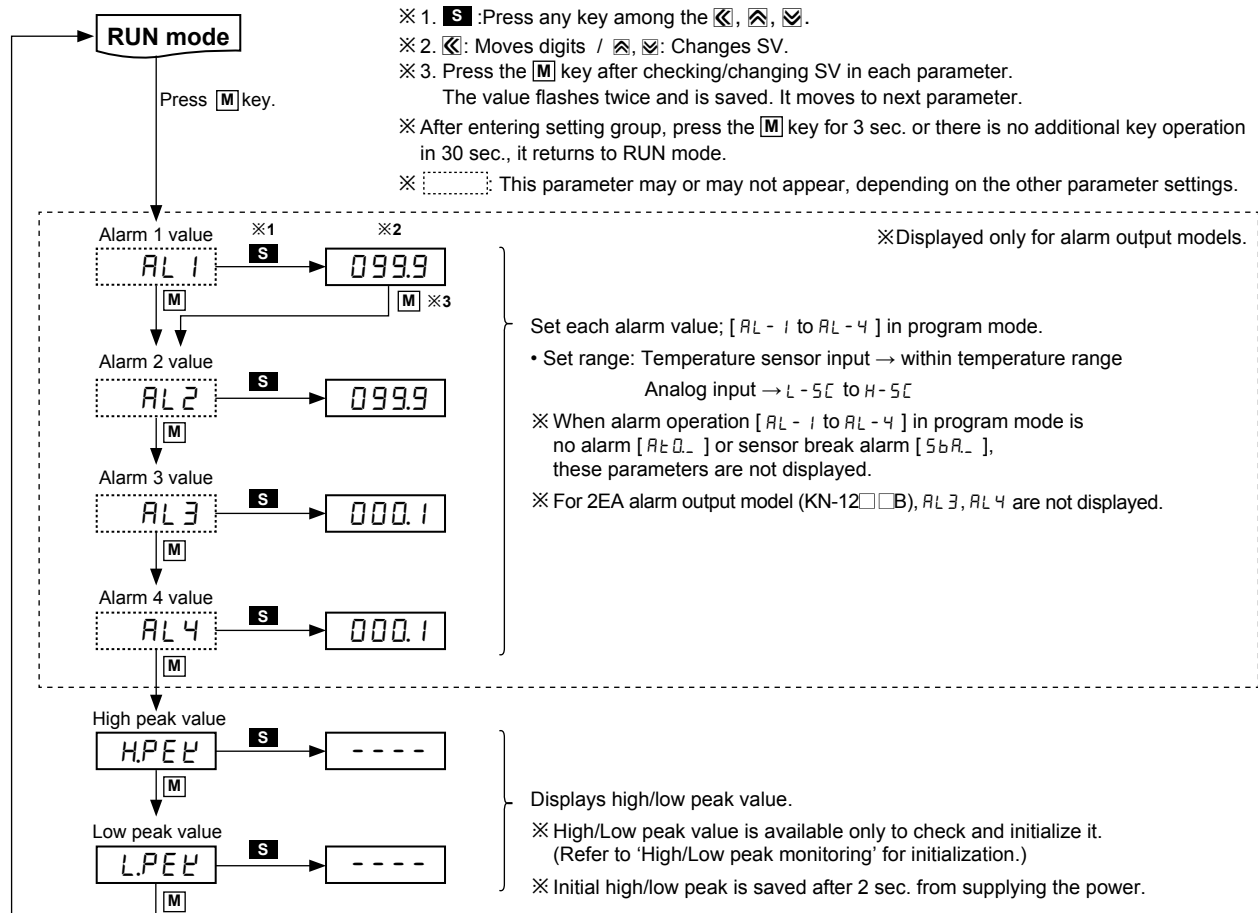

Program mode

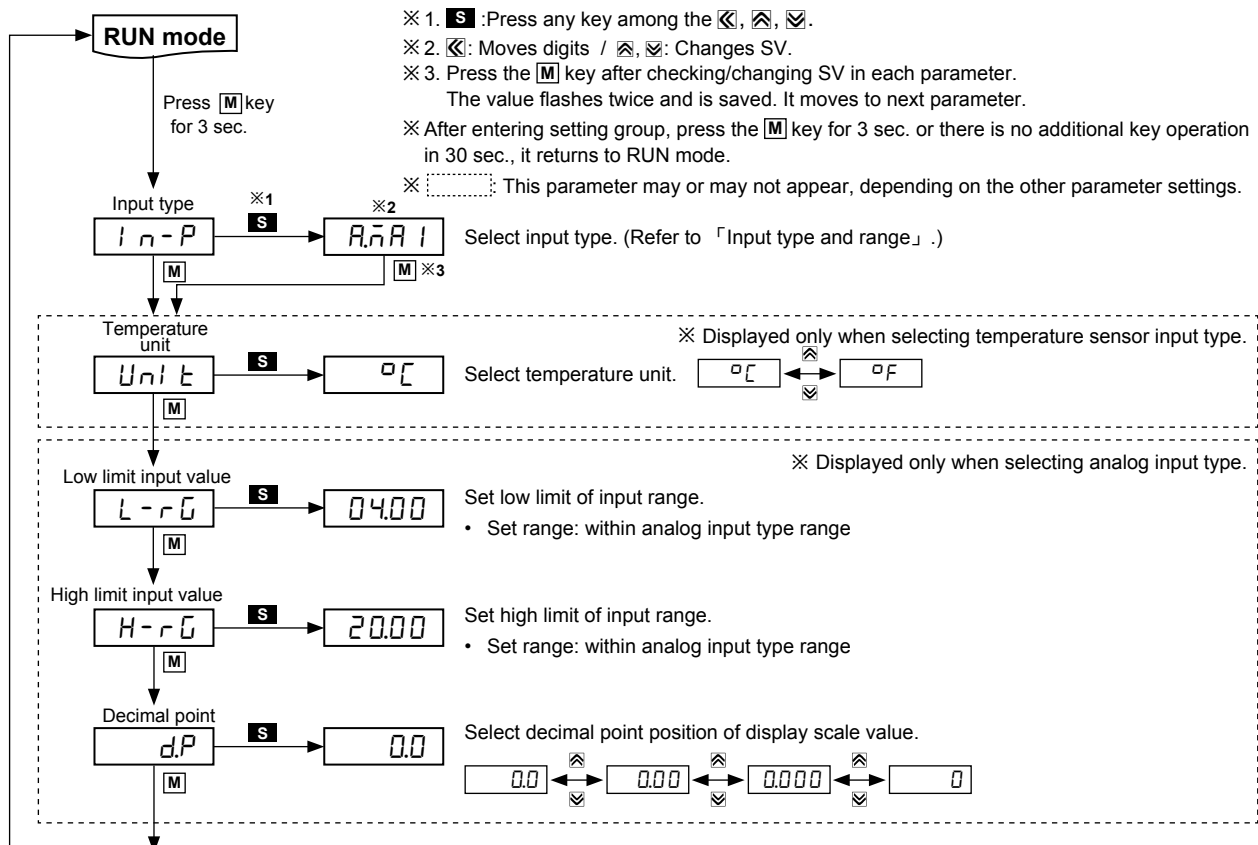

Bar Graph Digital Indicator

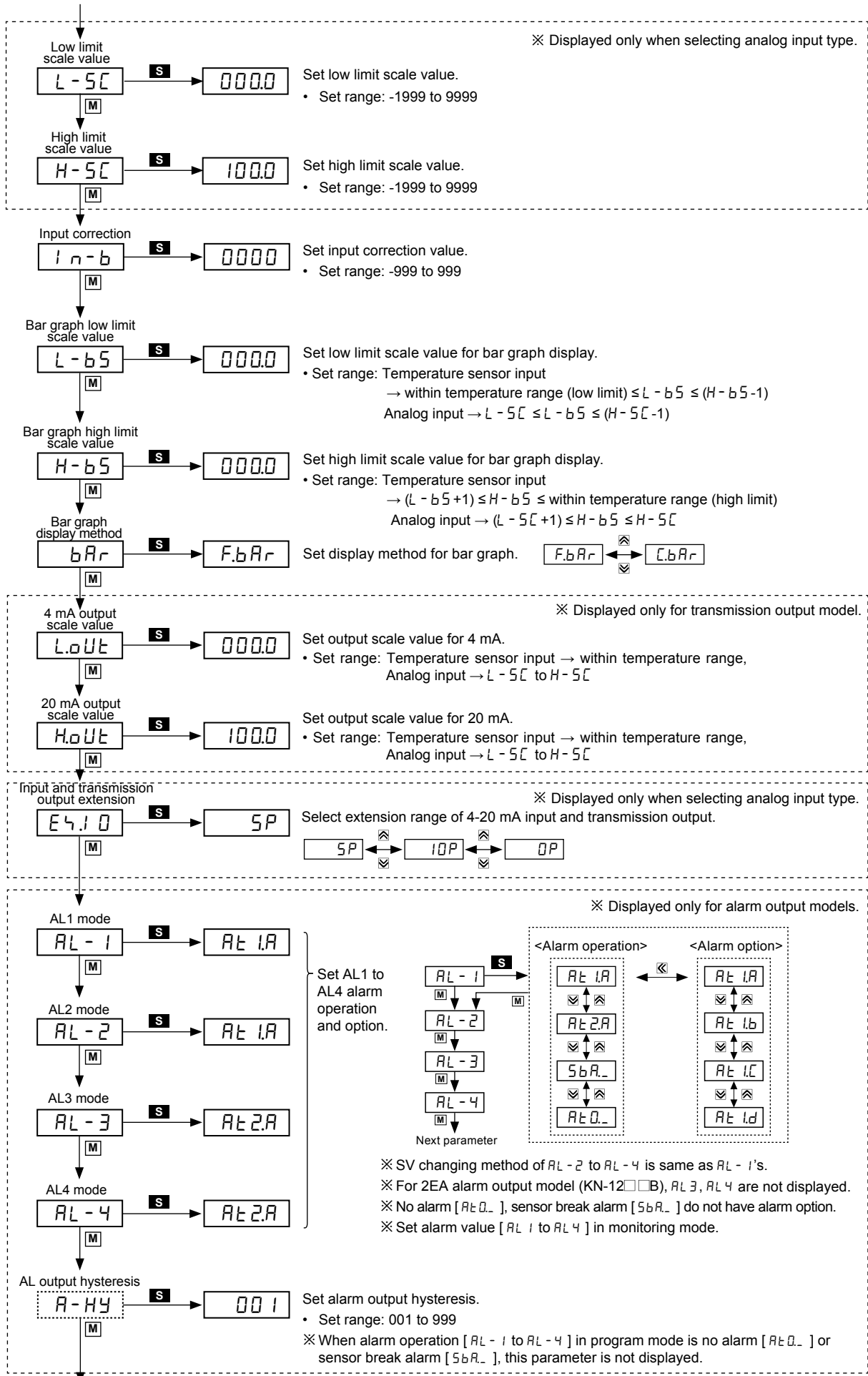

A. Recorder
B. Indicator
C. Converter
D. Controller
E. Thyristor unit
F. Pressure transmitter
G. Temp. transmitter
H. Accessories

KN-1000B
KN-2000W

KN-1000B Series

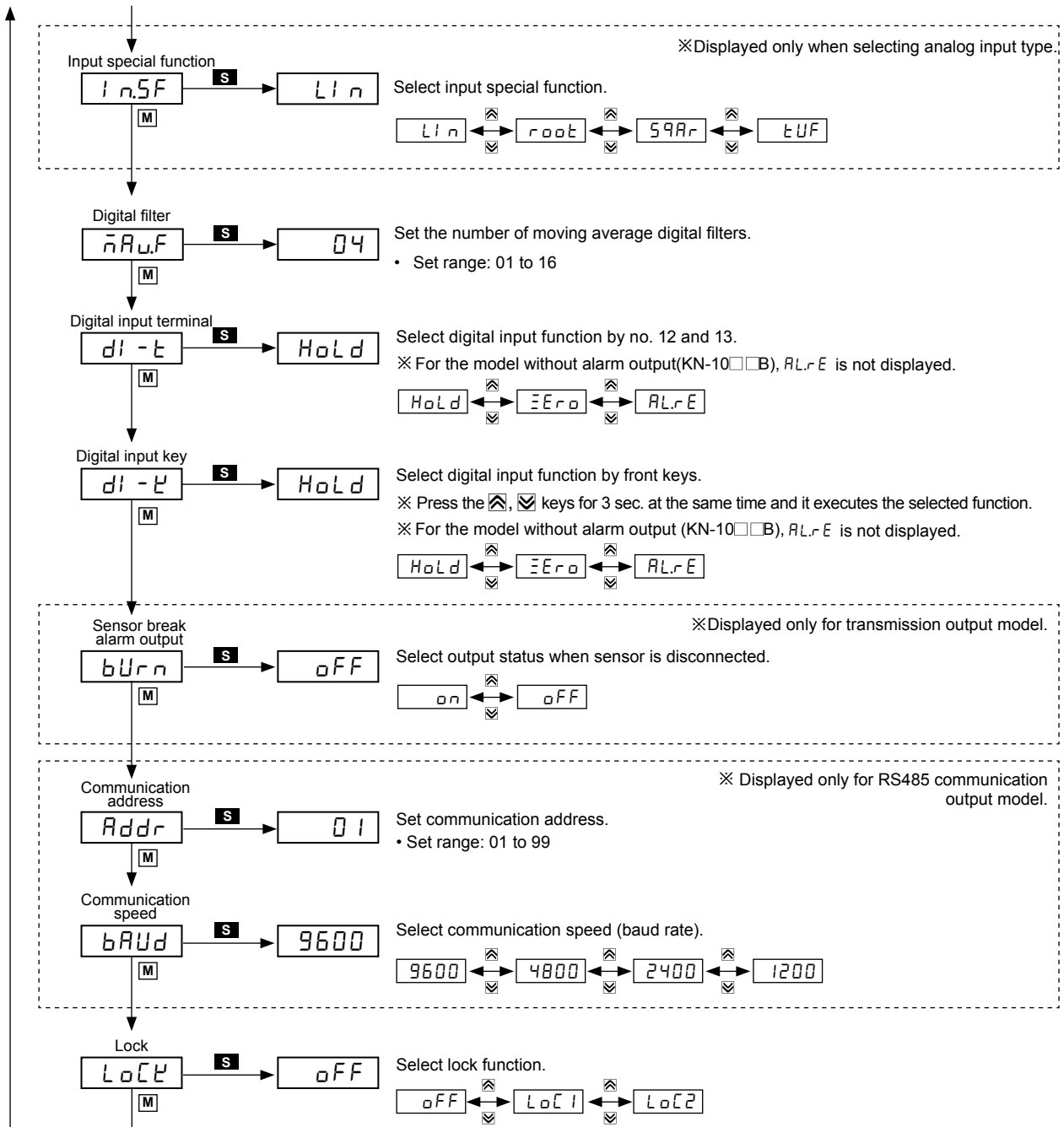

Bar Graph Digital Indicator

Factory default

■ Monitoring mode

Parameter	Default	Parameter	Default	Parameter	Default
AL1	099.9	AL3	000.1	HPEE	----
AL2	099.9	AL4	000.1	LPEE	----

■ Program mode

Parameter	Default	Parameter	Default	Parameter	Default	Parameter	Default
In-P	RnR.1	In-b	0000	AL-1	At1A	d1-t	Hold
Unit	°C	L-b5	0000	AL-2	At1A	d1-t	Hold
L-rG	00.00	H-b5	1000	AL-3	At2A	burn	oFF
H-rG	20.00	bAr	F.bAr	AL-4	At2A	Addr	01
dP	0.0	LoUt	0000	A-HY	001	bAUd	9600
L-5C	000.0	HoUt	1000	InSF	LIn	LoCE	oFF
H-5C	100.0	E4.10	5P	nARF	04		

Proper usage

■ Caution for using

- For connecting the power, use a crimp terminal (M3.5, min. 7.2 mm).
- The connection of this unit should be separated from the power line and high voltage line in order to prevent inductive noise.
- Install a power switch or a circuit breaker to supply or cut off the power.
- Switch or circuit breaker should be installed nearby users for convenient control.
- Do not use this unit near the high frequency instruments (high frequency welding machine & sewing machine, large capacity SCR controller).
- When supplying input, if HHHH or LLLL is displayed, measured input may have problem. Turn off the power and check the line.
- Installation environment.
 - ① It shall be used indoor.
 - ② Pollution Degree 2
 - ③ Altitude max. 2,000 m
 - ④ Installation category II
- It may cause malfunction if above instructions are not followed.

A. Recorder

B. Indicator

C. Converter

D. Controller

E. Thyristor unit

F. Pressure transmitter

G. Temp. transmitter

H. Accessories

KN-1000B

KN-2000W