

DIN W72×H72mm Up-Down Measure Counter

■ Features

- Parameter Setting
 - Input/Output operation mode, Max. counting speed, Decimal point position, OUT1/2 time (0.01 to 99.99sec), Selectable voltage input (PNP) method or no-voltage input (NPN) method, Selectable Multiply or Divide mode function.
- Memory protection for 10 years (using non-voltage semiconductor)
- Power supply: 100-240VAC 50/60Hz
- Built-in Microprocessor



⚠ Please read "Safety considerations" in operation manual before using.



■ Ordering Information

FM	4	M	1P	4	
					Power supply
					Output
					Function
					Display digit
					Size
			4		100-240VAC 50/60Hz
			1P		1-stage setting
			2P		2-stage setting
			I		Indicator
		M			Measure function
			4		9999 (4-digit)
			6		999999 (6-digit)
			FM		DIN W72×H72mm

■ Specifications

Model	1-stage setting	FM4M-1P4	FM6M-1P4
	2-stage setting	FM4M-2P4	FM6M-2P4
	Indicator	FM4M-I4	FM6M-I4
Display digit		4-digit	6-digit
Character size (W×H)		6×10mm	4×8mm
Power supply		100-240VAC~ 50/60Hz	
Permissible voltage range		90 to 110% of rated voltage	
Power consumption		●1-stage: max. 4.6VA	●2-stage: max. 5.8VA ●Indicator: max. 3.8VA
Max. counting speed of CP1/CP2		Selectable 1cps/30cps/300cps/2kcps/5kcps	
Return time		Max. 500ms	
Min. signal width		RESET: approx. 20ms	
Input method		Selectable voltage input (PNP) method or no-voltage input (NPN) method [Voltage input (PNP) method]-input impedance: max. 10.8kΩ, [H]: 5-30VDC≐, [L]: 0-2VDC [No-voltage input (NPN) method]-short-circuit impedance: max. 470Ω, short-circuit residual voltage: max. 1VDC, open-circuit impedance: min. 100kΩ	
One-shot output time		0.01 to 99.99 sec	
Control output	Contact	Type	●1-stage: Instantaneous SPDT (1c) ●2-stage: Instantaneous OUT1-SPST (1a), Instantaneous OUT2-SPST (1a)
		Capacity	250VAC~ 3A, 30VDC≐ 3A resistive load
	Solid state	Type	●1-stage: 1 NPN open collector ●2-stage: OUT1-1 NPN open collector, OUT2-1 NPN open collector
		Capacity	NPN open collector output ●Load voltage: max. 30VDC≐ ●Load current: max. 100mA ●Residual voltage: max 1VDC≐
Relay life cycle	Mechanical		Min. 5,000,000 operations
		Electrical	Min. 100,000 operations (250VAC 3A resistive load)
Insulation resistance		Over 100MΩ (at 500VDC megger)	
External power supply		Max. 12VDC≐ ±10% 50mA	
Memory retention		Approx. 10 years (non-volatile memory)	
Dielectric strength		2,000VAC 50/60Hz for 1 min (between all terminals and case)	
Noise immunity		±2kV the square wave noise (pulse width 1μs) by noise simulator	

(A) Photoelectric Sensors

(B) Fiber Optic Sensors

(C) Door/Area Sensors

(D) Proximity Sensors

(E) Pressure Sensors

(F) Rotary Encoders

(G) Connectors/ Connector Cables/ Sensor Distribution Boxes/Sockets

(H) Temperature Controllers

(I) SSRs / Power Controllers

(J) Counters

(K) Timers

(L) Panel Meters

(M) Tacho / Speed / Pulse Meters

(N) Display Units

(O) Sensor Controllers

(P) Switching Mode Power Supplies

(Q) Stepper Motors & Drivers & Controllers



(R) Graphic/ Logic Panels

(S) Field Network Devices

(T) Software

FM Series

Specifications

Model	1-stage setting	FM4M-1P4	FM6M-1P4
	2-stage setting	FM4M-2P4	FM6M-2P4
	Indicator	FM4M-I4	FM6M-I4
Vibration	Mechanical	0.75mm amplitude at frequency 10 to 55Hz (for 1 min) in each X, Y, Z direction for 1 hour	
	Malfunction	0.5mm amplitude at frequency 10 to 55Hz (for 1 min) in each X, Y, Z direction for 10 minutes	
Shock	Mechanical	300m/s ² (approx. 30G) in each X, Y, Z direction for 3 times	
	Malfunction	100m/s ² (approx. 10G) in each X, Y, Z direction for 3 times	
Environment	Ambient temp.	-10 to 55°C, storage: -25 to 65°C	
	Ambient humi.	35 to 85%RH, storage: 35 to 85%RH	
Protection structure		IP20 (front part, IEC standard)	
Approval		 	
Weight*1	1-stage setting	Approx. 245g (approx. 180g)	
	2-stage setting	Approx. 265g (approx. 200g)	
	Indicator	Approx. 225g (approx. 160g)	

※1: The weight includes packaging. The weight in parenthesis is for unit only.

※Environment resistance is rated at no freezing or condensation.

Connections

FM□M-2P4

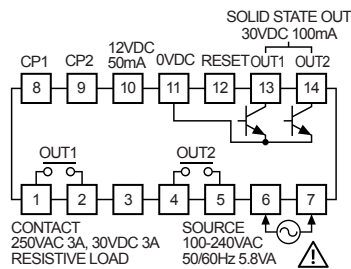

FM□M-1P4

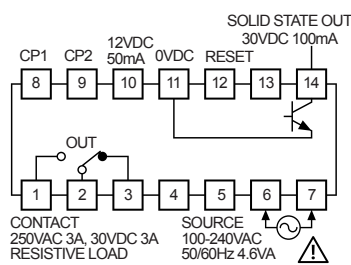

FM□M-I4

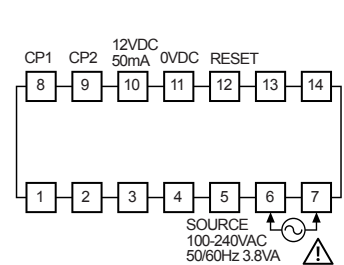

Dimensions

(unit: mm)

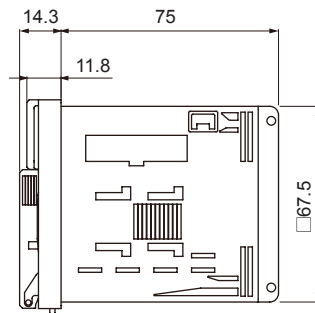
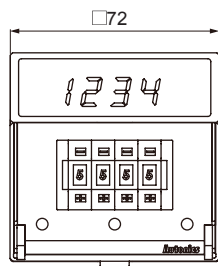

Bracket

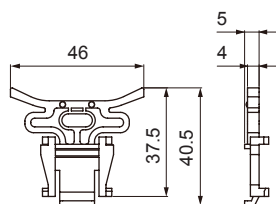

Panel cut-out

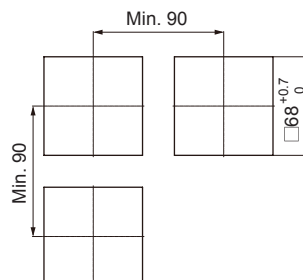

Up-Down Measure Counter

Input Connections

Voltage input (PNP)

Solid-state input (standard sensor: PNP output type sensor)

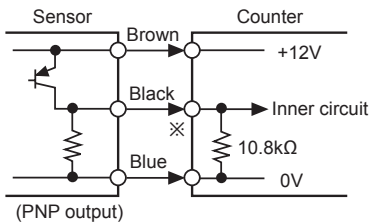

※CP1, CP2, RESET input part

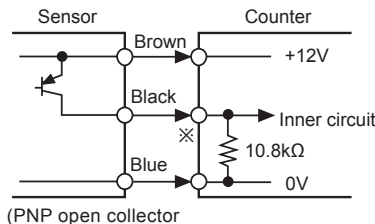

(PNP open collector output)

Contact input

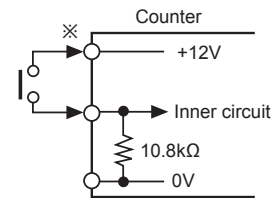

※Counting speed : Set as 1 or 30cps

No-voltage input (NPN)

Solid-state input (standard sensor: NPN output type sensor)

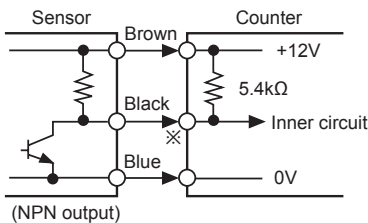

※CP1, CP2, RESET input part

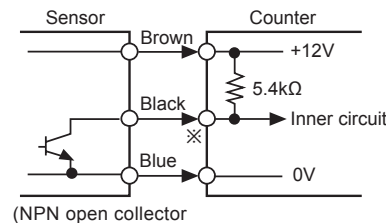

(NPN open collector output)

Contact input

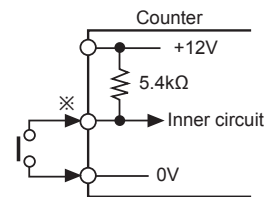

※Counting speed : Set as 1 or 30cps

Input & Output Connections

When operation load by sensor power

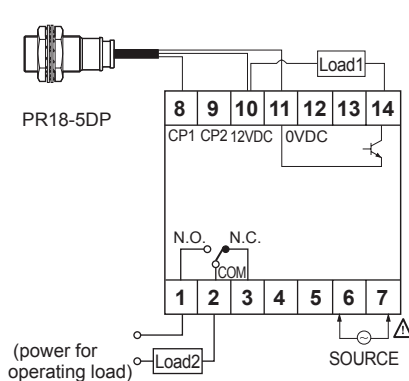

- The sum of operating current capacity of load 1 and sensor should not be over external power capacity (50mA).

When operating load by external power

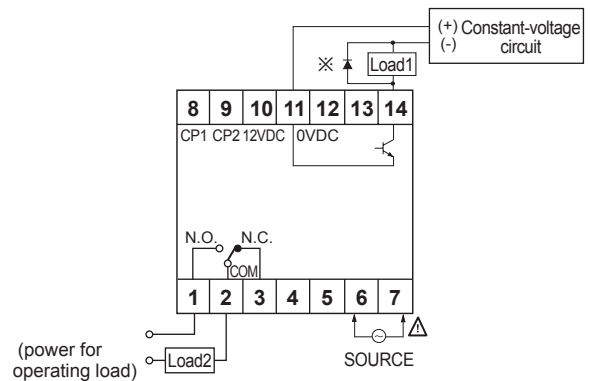

- The capacity of load 1 should not be over transistor switching capacity (max. 30VDC, 100mA)
- Do not supply the reverse polarity power.
- ※when using inductive load (relay, etc.), connector surge absorber at both ends of the load 1

(A)	Photoelectric Sensors
(B)	Fiber Optic Sensors
(C)	Door/Area Sensors
(D)	Proximity Sensors
(E)	Pressure Sensors
(F)	Rotary Encoders
(G)	Connectors/ Connector Cables/ Sensor Distribution Boxes/Sockets
(H)	Temperature Controllers
(I)	SSRs / Power Controllers
(J)	Counters
(K)	Timers
(L)	Panel Meters
(M)	Tacho / Speed / Pulse Meters
(N)	Display Units
(O)	Sensor Controllers
(P)	Switching Mode Power Supplies
(Q)	Stepper Motors & Drivers & Controllers
(R)	Graphic/ Logic Panels
(S)	Field Network Devices
(T)	Software

Parameter Setting

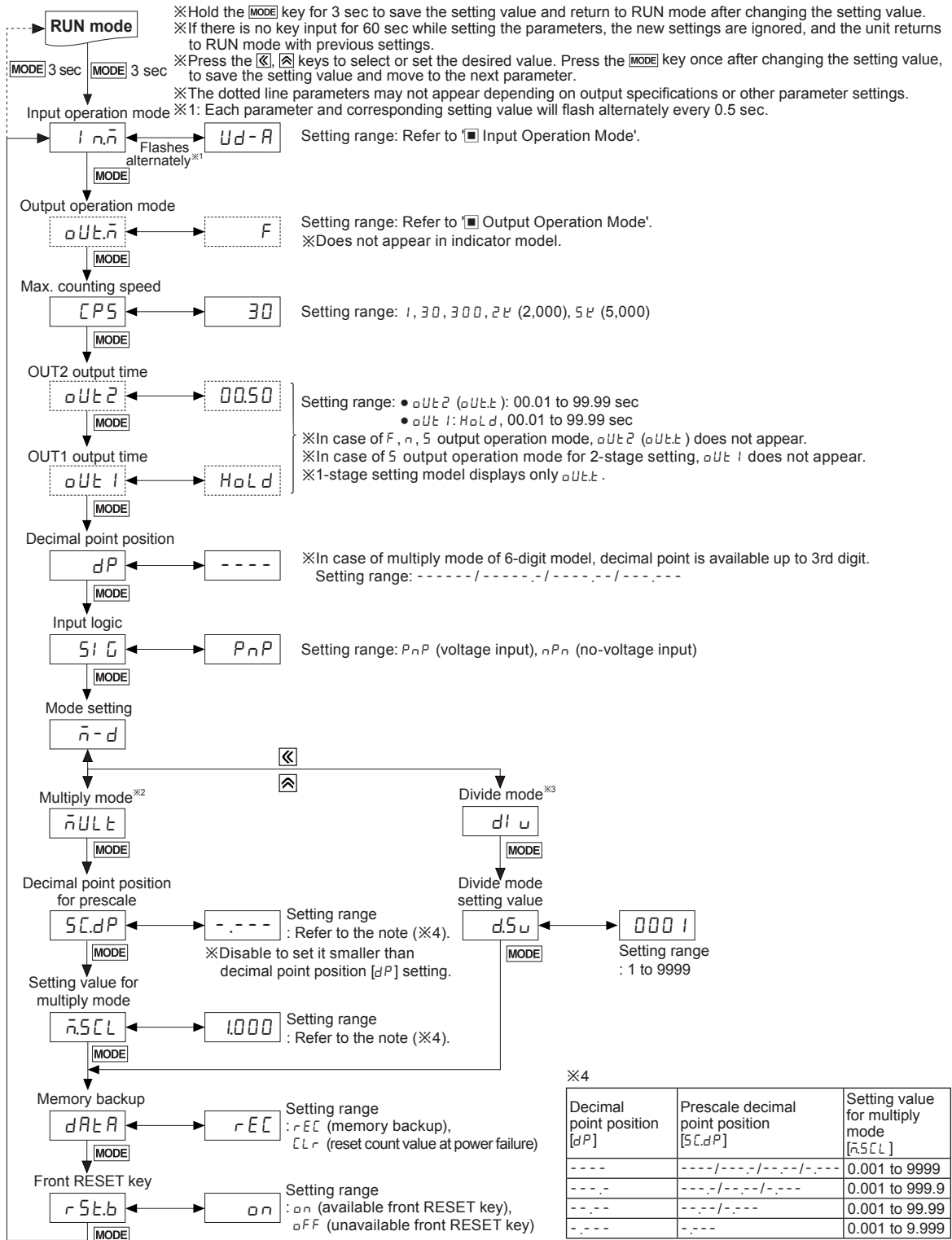

※2: Multiply mode [$\bar{n}ULt$]: Displayed by multiplying input signal and setting value.
 Input signal × Setting value = Display value (input signal: 1, setting value: 4, it displays 4(1×4))
 ※3: Divide mode [dI u]: Displays 1 when input signals are input as the setting value.
 Input signal / Setting value = Display value (input signal: 4, setting value: 4, it displays 1(4/4))

Up-Down Measure Counter

■ Measure Counter

Measure counter sets multiply or divide integer per 1 pulse input.

● Multi Mode

It multiplies the inner SW3 setting value at a count input signal and displays it.

Input signal (N) × Multi Mode preset value = Indication value

∴ $N \times 4 = 4, 8, 12 \dots$ ($N=1, 2, 3 \dots$)

● Divide Mode

It displays as 1 when the count input signal is entered as preset value of inner SW3.

$\frac{\text{Input signal (N)}}{\text{Divide Mode preset value}} = \text{Indication value}$

∴ $\frac{N}{5} = 1, 2, 3 \dots$ ($N=5, 10, 15 \dots$)

※Please be cautious the error can occur when down count is executed during up count.

■ Counting Operation for Indicator (FM□M-I4)

● Input mode: Up

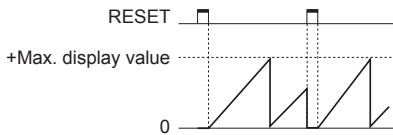

● Input mode: Down

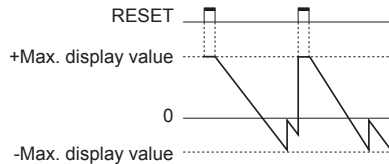

● Input mode: Up / Down-A, B, C

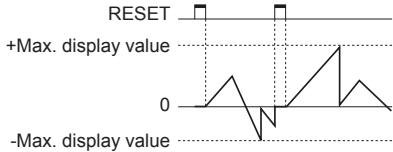

● Input mode: Up / Down-D, E, F

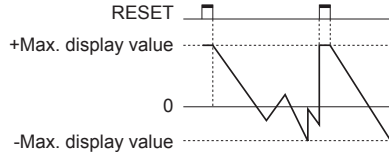

※- display is only for F, K, Q, S output operation mode and it cannot be set.

■ Factory Default

Parameter	Default	Parameter	Default	Parameter	Default	Parameter	Default
Unit	Ud-R	OUT2	00.50	StG	PnP	ASC L	1000
OUT1	F	OUT1	Hold	~d	~ULt	dRA R	rEC
CP5	30	dP	---	SCdP	---	rSt.b	on

■ Error Display and Output Operation

Error Display	Error description	Troubleshooting
Err0	Setting value is 0.	Change the setting value anything but 0.

※When error occurs, the output turns OFF.

※When 1st setting value is set as 0 (zero), OUT1 maintains OFF.

When 2nd setting value is smaller than 1st setting value, 1st setting value is ignored and only OUT2 output operates.

※Indicator model does not have error display function.

(A) Photoelectric Sensors

(B) Fiber Optic Sensors

(C) Door/Area Sensors

(D) Proximity Sensors

(E) Pressure Sensors

(F) Rotary Encoders

(G) Connectors/ Connector Cables/ Sensor Distribution Boxes/Sockets

(H) Temperature Controllers

(I) SSRs / Power Controllers

(J) Counters

(K) Timers

(L) Panel Meters

(M) Tacho / Speed / Pulse Meters

(N) Display Units

(O) Sensor Controllers

(P) Switching Mode Power Supplies

(Q) Stepper Motors & Drivers & Controllers

(R) Graphic/ Logic Panels

(S) Field Network Devices

(T) Software

Input Operation Mode

※CP: Clock Pulse

Input mode	Voltage input (PNP) method	No-voltage input (PNP) method
Up/Down-A command input [Ud - A]		
Up/Down-B individual input [Ud - b]		
Up/Down-C phase difference input [Ud - C]		
Up adding input [UP]		
Up/Down-D command input [Ud - d]		
Up/Down-D individual input [Ud - E]		
Up/Down-F phase difference input [Ud - F]		
Down subtracting input [dn]		

※A: over min. signal width, B: over than 1/2 of min. signal width. If the signal is smaller than these width, it may cause counting error (±1).

Up-Down Measure Counter

Output Operation Mode

		 One-shot output of OUT2 (0.01 to 99.99 sec)	 Self-holding output	 One-shot output of OUT1 (0.01 to 99.99 sec)	 Self-holding output
Output mode	Input mode			Operation	
	Up, Up/Down-A, B, C			Down, Up/Down-D, E, F	
F [F]					After count-up, counting display value increases or decreases until reset signal input is applied and self-holding output is maintained.
N [N]					After count-up, counting display value and self-holding output are maintained until reset signal input is applied.
C [C]					When count-up, counting display value is reset and it counts simultaneously. Self-holding output of OUT1 turns OFF after one-shot output time of OUT2. One-shot output time of OUT1 is regardless of OUT2 output.
R [R]					After count-up, counting display value is reset after one-shot output time of OUT2 and it counts simultaneously. Self-holding output of OUT1 turns OFF after one-shot output time of OUT2. One-shot output time of OUT1 is regardless of OUT2 output.
K [K]					After count-up, counting display value increases or decreases until reset signal input is applied. Self-holding output of OUT1 turns OFF after one-shot output time of OUT2. One-shot output time of OUT1 is regardless of OUT2 output.
P [P]					After count-up, counting display value is maintained while OUT2 output is ON. Counting value is internally reset and it counts simultaneously. When OUT2 output is OFF, displays counting value while OUT2 output is ON, and it increases or decreases. Self-holding output of OUT1 turns OFF after one-shot output time of OUT2.
Q [Q]					After count-up, counting display value increases or decreases during one-shot time of OUT2. Self-holding output of OUT1 turns OFF after one-shot output time of OUT2. One-shot output time of OUT1 is regardless of OUT2 output.
S [S]	<p style="text-align: center;">Up</p>			<p style="text-align: center;">Down</p>	<ul style="list-style-type: none"> ●Up, Up/Down-A, B, C input mode <ul style="list-style-type: none"> : OUT1 output maintains ON when counting display value is larger or equal than 1st setting value. : OUT2 output maintains ON when counting display value is larger or equal than 2nd setting value. ●Down, Up/Down-D, E, F input mode <ul style="list-style-type: none"> : OUT1 output maintains ON when counting display value is smaller or equal than 1st setting value. : OUT2 output maintains ON when counting display value is smaller or equal than 2nd setting value.
	<p style="text-align: center;">Up/Down-A, B, C</p>			<p style="text-align: center;">Up/Down-D, E, F</p>	

(A)	Photoelectric Sensors
(B)	Fiber Optic Sensors
(C)	Door/Area Sensors
(D)	Proximity Sensors
(E)	Pressure Sensors
(F)	Rotary Encoders
(G)	Connectors/ Connector Cables/ Sensor Distribution Boxes/Sockets
(H)	Temperature Controllers
(I)	SSRs / Power Controllers
(J)	Counters
(K)	Timers
(L)	Panel Meters
(M)	Tacho / Speed / Pulse Meters
(N)	Display Units
(O)	Sensor Controllers
(P)	Switching Mode Power Supplies
(Q)	Stepper Motors & Drivers & Controllers
(R)	Graphic/ Logic Panels
(S)	Field Network Devices
(T)	Software

FM Series

■ Proper Usage

- Follow instructions in 'Proper Usage'. Otherwise, it may cause unexpected accidents.
- Use the product, 0.1 sec after supplying power.
- When supplying or turning off the power, use a switch or etc. to avoid chattering.
- Install a power switch or circuit breaker in the easily accessible place for supplying or disconnecting the power.
- In case of contact input, set count speed to low speed mode (1cps or 30 cps) to operate.
If set to high speed mode (300cps, 2kcps, 5kcps), counting error occurs due to chattering.
- Keep away from high voltage lines or power lines to prevent inductive noise.
In case installing power line and input signal line closely, use line filter or varistor at power line and shielded wire at input signal line.
Do not use near the equipment which generates strong magnetic force or high frequency noise.
- This product may be used in the following environments.
 - ①Indoors (in the environment condition rated in 'Specifications')
 - ②Altitude max. 2,000m
 - ③Pollution degree 2
 - ④Installation category II