



IFD9507

Ethernet Communication Module

Application Manual



<http://www.delta.com.tw/industrialautomation>

Warning

- ✓ Please read this instruction carefully before use and follow this instruction to operate the device in order to prevent damages on the device or injuries to staff.
- ✓ Switch off the power before wiring.
- ✓ IFD9507 is an OPEN TYPE device and therefore should be installed in an enclosure free of airborne dust, humidity, electric shock and vibration. The enclosure should prevent non-maintenance staff from operating the device (e.g. key or specific tools are required for operating the enclosure) in case danger and damage on the device may occur.
- ✓ IFD9507 is to be used for controlling the operating machine and equipment. In order not to damage it, only qualified professional staff familiar with the structure and operation of IFD9507 can install, operate, wire and maintain it.
- ✓ DO NOT connect input AC power supply to any of the I/O terminals; otherwise serious damage may occur. Check all the wirings again before switching on the power and DO NOT touch any terminal when the power is switched on. Make sure the ground terminal ⊕ is correctly grounded in order to prevent electromagnetic interference.

Table of Contents

1	INTRODUCTION.....	4
	1.1 Features	4
	1.2 Specifications	4
2	PRODUCT PROFILE & OUTLINE	6
	2.1 Dimension	6
	2.2 Product Profiles	6
	2.3 LED Indicators	6
	2.4 RJ-11 PIN Definition	7
	2.5 RJ-45 PIN Definition	7
	2.6 RS-232 PIN Definition	7
	2.7 Address Switch	7
	2.8 Data Format	8
	2.9 Baud Rate for Modbus Communication	8
	2.10 Feed-through Terminal PIN Definition	8
3	INSTALLATION & WIRING	9
	3.1 How to Install	9
	3.2 How to Connect IFD9507 to Network	9
4	REGISTERS IN IFD9507	10
	4.1 Basic Registers (BR)	10
	4.2 Explanations on BR	10
	4.3 Alarm Registers (AL) in IFD9507	13

4.4	In buffer registers (IN) in IFD9507	14
4.5	Out buffer registers (OUT) in IFD9507	15
5	MONITORING FUNCTIONS	15
5.1	Monitor Bit Registers (MB)	15
5.2	Monitor Word Registers (MW)	16
6	SETTING UP DEVICE ADDRESS AND RELAY ADDRESS IN SLAVE MODE (FOR MODBUS TCP PROTOCOL ONLY)	17
7	SETTING UP DEVICE ADDRESS AND OTHER NETWORK SETTINGS IN SLAVE MODE	17
8	MODBUS COMMUNICATION	18
8.1	Function Codes Supported	18
8.2	Exception Codes Supported	18
8.3	Device Type & Device Address	18
9	ETHERNET/IP COMMUNICATION	19
9.1	Service code supported	19
9.2	Object supported	19
9.3	CIP General Status Code (Reference Volume 1:CIP Common Specification Appendix B)	20
9.4	Connection Manager Service Request Error Codes (Reference Volume 1:CIP Common Specification Table3-5.29)	20
10	SETTING UP THE SOFTWARE - DCISOFT	21
10.1	Setting up Communication & Searching for Modules in DCISoft	21
10.2	Basic Settings	23
10.3	Network Settings	24
10.4	Setting up E-Mails	26
10.5	Monitoring Settings	27
10.6	IP Filter	28
10.7	Ethernet/IP settings	29
10.8	User Defined Settings	31
10.9	Virtual COM	33
10.10	Security Settings	36
10.11	Returning to Default Settings	37
11	SETTING UP CONFIGURATION BY HOMEPAGE	38
11.1	Webpage connection	38
11.2	Basic settings	39
11.3	Setting up E-Mails	40
11.4	IP filter	41
11.5	Security Settings	42
11.6	Returning to default setting	43
11.7	Monitoring settings	43
11.8	Ethernet/IP	45
11.9	User Define	47

12	APPLICATION EXAMPLES – DCISOFT	49
12.1	Setting up & Unlocking Password	49
12.2	Password Loss (Returning to Default Settings by RS-232).....	51
12.3	IP Filter Protection.....	51
12.4	Application of E-Mail	53
12.5	Monitoring Mode	54
12.6	Application of Virtual COM Port.....	56
13	APPLICATION EXAMPLES – AB SOFTWARE (REVISION:2.10.118.0)	61
13.1	Serial Slave	61
13.2	Serial Master	64

1 Introduction

Thank you for choosing Delta's IFD9507 module. To correctly install and operate IFD9507, please read the manual carefully before using the module.

IFD9507 is an Ethernet communication module for remote setting and communication through Delta's DCISoft 1.01.

IFD9507 has 3 digital input contacts which will send messages to designated E-Mail addresses after being triggered. IFD9507 supports Modbus TCP communication protocol and can conduct remote monitoring by using graphic software or human machine interface. IFD9507 can be the master of Modbus TCP, sending out Modbus TCP instructions and controlling the peripheral equipment. IFD9507 supports Ethernet/IP communication protocol and can control device between Ethernet/IP protocols with Modbus protocol. IFD9507 can be a slave as well, receiving Modbus instructions sent from other masters and transferring them to another Modbus communication network or Ethernet/IP communication network through Ethernet. In addition, under MDI/MDI-X auto-detection, it does not need to jump wire in selecting the network cable. See the contents below for more detailed instructions on IFD9507 module.

1.1 Features

- Auto-detects 10/100 Mbps transmission speed; MDI/MDI-X auto-detection
- The monitor table temporarily stores the monitored data for the user to fast save or acquire the data.
- Supports Modbus TCP protocol (supports Master and Slave mode)
- Supports Ethernet/IP protocol (supports Master and Slave mode)
- Able to send out emails after being triggered.
- The station address, RS-485 communication format and baud rate can be set up externally

1.2 Specifications

■ Network interface

Item	Specification
Interface	RJ-45 with Auto MDI/MDIX
Number of ports	1 Port
Transmission method	IEEE802.3, IEEE802.3u
Transmission cable	Category 5e
Transmission speed	10/100 Mbps Auto-Detection
Communication protocol	ICMP, IP, TCP, UDP, DHCP, SMTP, Modbus TCP, Ethernet/IP

■ Serial communication interface (COM1)

Item	Specification
Interface	Mini Dim
Number of ports	1 Port
Transmission method	RS-232
Transmission cable	DVPACAB215 / DVPACAB230 / DVPACAB2A30
Transmission speed	110, 150, 300, 600, 1200, 2400, 4800, 9600, 19200, 38400, 57600, 115200
Communication protocol	Modbus, Delta Configuration, User Define

■ Serial communication interface (COM2)

Item	Specification
Interface	RJ-11
Number of ports	1 Port
Transmission method	RS-485
Transmission speed	110, 150, 300, 600, 1200, 2400, 4800, 9600, 19200, 38400, 57600, 115200
Communication protocol	Modbus, User Define

■ Terminal block

Item	Specification
Interface	Feed-through terminal 10PIN
Transmission method	RS-485
Transmission distance	1,200m
Transmission speed	110, 150, 300, 600, 1200, 2400, 4800, 9600, 19200, 38400, 57600, 115200
Communication protocol	Modbus, User Define
Max. number of stations	32

■ Environment

Item	Specification
Noise immunity	ESD (IEC 61131-2, IEC 61000-4-2): 8KV Air Discharge EFT (IEC 61131-2, IEC 61000-4-4): Power Line: ± 2 KV, Digital Input: ± 2 KV, Communication I/O: ± 2 KV RS (IEC 61131-2, IEC 61000-4-3): 80MHz ~ 1GHz, 10V/m. 1.4GHz ~ 2.0GHz, 10V/m Conducted Susceptibility Test (EN61000-4-6, IEC61131-2 9.10): 150KHz ~ 80MHz, 3V/m Surge Test (Biwave IEC61132-2, IEC61000-4-5): Power line 0.5KV DM, Ethernet 0.5KV CM, RS-485 0.5KV CM
Operation temperature	0°C ~ 55 °C (temperature), 50 ~ 95% (humidity), pollution degree 2
Storage temperature	-25°C ~ 70 °C (temperature), 5 ~ 95% (humidity)
Vibration/shock immunity\	International standards: IEC61131-2, IEC 68-2-6 (TEST Fc)/IEC61131-2 & IEC 68-2-27 (TEST Ea)
Certificates	IEC 61131-2, UL508

■ Electrical specifications

Item	Specification
Power voltage	24VDC (-15% ~ 20%) supplied by feed-through terminal
Power consumption	3W
Insulation voltage	500V
Weight (g)	140g

2 Product Profile & Outline

2.1 Dimension

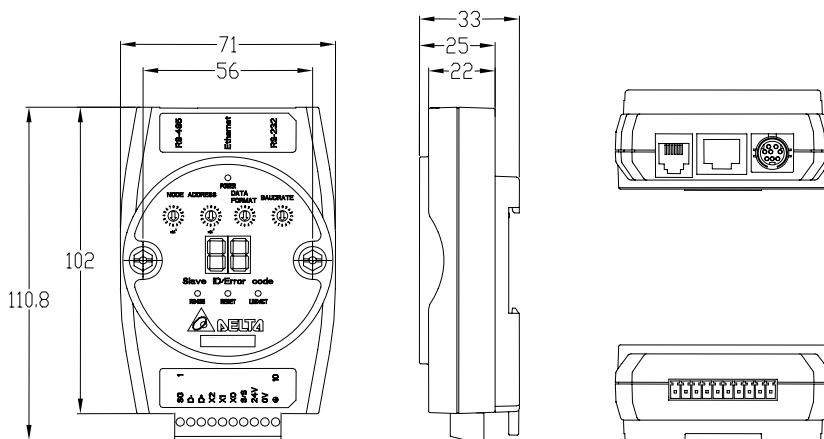

Unit: mm

2.2 Product Profiles

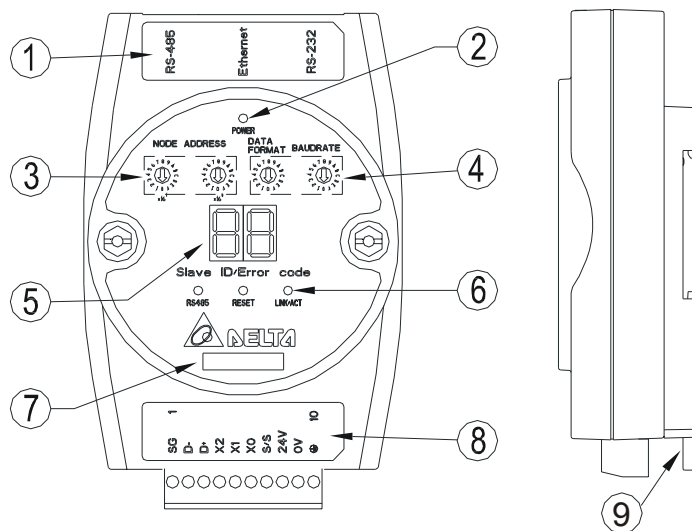

- | | |
|---|--|
| ① Communication ports: RS-485, Ethernet, RS-232 | ⑥ RS-485 indicator, Reset button, Ethernet indicator |
| ② Power indicator | ⑦ Module name |
| ③ Address setup rotary switch | ⑧ RS-485 connector, digital input points, power input point, earth point |
| ④ Communication format/baud rate setup switch | ⑨ DIN rail connector |
| ⑤ Message display | |

2.3 LED Indicators

Name	Color	Function
POWER	Green	Power status
RS-485	Green	Status of series communication port
LINK/ACT	Green	Status of network communication

2.4 RJ-11 PIN Definition

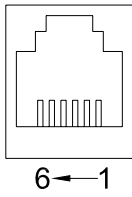
RJ-11 sketch	PIN.	Signal	Definition
	1	--	N/C
	2	--	N/C
	3	D+	Positive pole for data
	4	D-	Negative pole for data
	5	GND	Reference
	6	--	N/C

2.5 RJ-45 PIN Definition

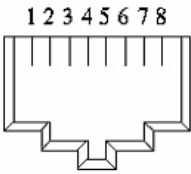
RJ-45 sketch	PIN	Signal	Definition
	1	Tx+	Positive pole for data transmission
	2	Tx-	Negative pole for data transmission
	3	Rx+	Positive pole for data receiving
	4	--	N/C
	5	--	N/C
	6	Rx-	Negative pole for data receiving
	7	--	N/C
	8	--	N/C

2.6 RS-232 PIN Definition

PIN	Signal	Content
1	--	N/C
2	--	N/C
3	--	N/C
4	Rx	Reception data
5	Tx	Transmission data
6	--	N/C
7	--	N/C
8	GND	Ground

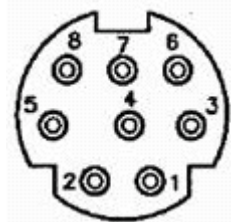

2.7 Address Switch

Switch setting	Content
01...F7	Valid node address setting

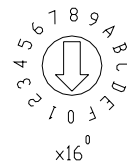
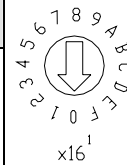

2.8 Data Format

Switch setting	Format	Switch setting	Format
0	7-N-1	8	7-N-2
1	8-N-1	9	8-N-2
2	7-O-1	A	7-O-2
3	8-O-1	B	8-O-2
6	7-E-1	E	7-E-2
7	8-E-1	F	8-E-2

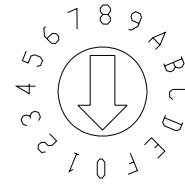

2.9 Baud Rate for Modbus Communication

Switch setting	Baud rate	Switch setting	Baud rate
1	110	7	4,000
2	150	8	9,600
3	300	9	19,200
4	600	A	38,400
5	1,200	B	57,600
6	2,400	C	115,200

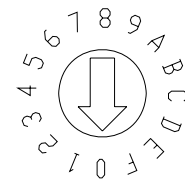

2.10 Feed-through Terminal PIN Definition

PIN	Signal	Content
1	SG	Reference ground of signal
2	D-	Data-
3	D+	Data-
4	X2	Digital input 2
5	X1	Digital input 1
6	X0	Digital input 0
7	S/S	Reference ground of digital input
8	24V	+24V input
9	0V	0V input
10		Earth ground

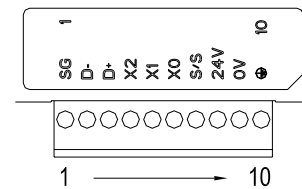

3 Installation & Wiring

This section gives instructions on how to connect IFD9507 with other devices and how to connect IFD9507 to the network.

3.1 How to Install

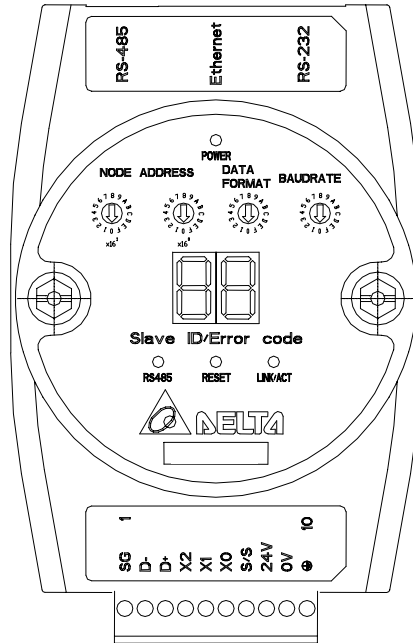

3.2 How to Connect IFD9507 to Network

Connect IFD9507 to the Ethernet hub by twisted pair cable CAT-5e. IFD9507 has auto MDI/MDIX function; therefore, IFD9507 does not need to jump wire if selecting CAT-5e. The network connection between the PC and IFD9507:

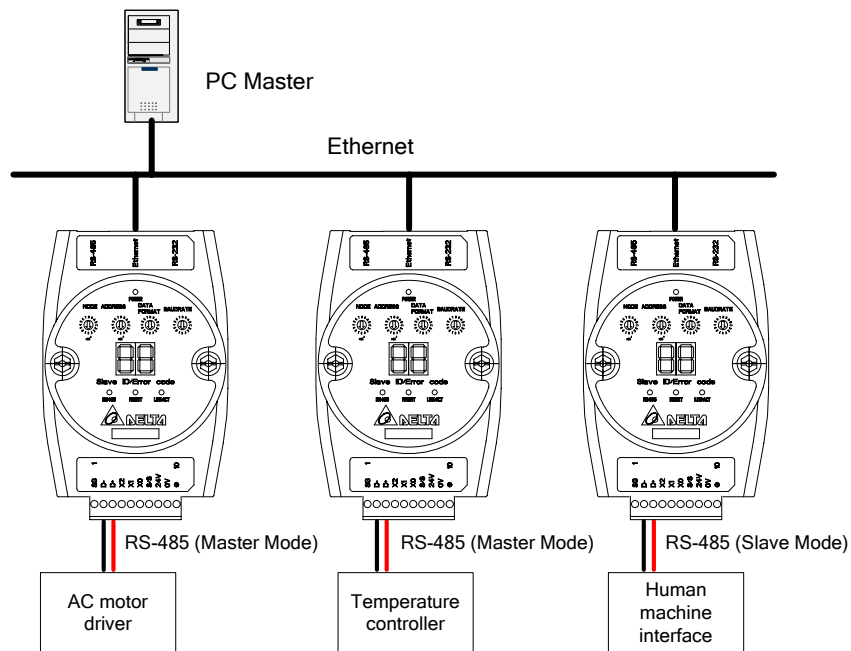

4 Registers in IFD9507

4.1 Basic Registers (BR)

BR#	Attribute	Content	Explanation	Default	Latched
0	R	Model name	Set up by the system; read only. The model code of IFD9507= H'0201		Yes
1	R	Firmware version	Displaying the current firmware version in hex, e.g. V1.2 is indicated as high byte = 0x01 and low byte = 0x20.		Yes
2	R	Release date of the version	Displaying the date in decimal form. 10,000s digit and 1,000s digit are for "month"; 100s digit and 10s digit are for "day". For 1s digit: 0 = morning; 1 = afternoon. Example: 12191 indicates the version released in the afternoon of December 19.		Yes
3		Reserved			
4	R/W	Communication format	See the table of communication format setting		No
5	R/W	Baud rate	See the table of baud rate setting		No
6	R/W	Address	For setting up the station address		No
7	R	Number of DI/DO points	DI: high byte; DO: low byte	0x300	Yes
8		Reserved			
9	R	Error code	Displaying the errors. See the table of error codes.	0	No
10		Reserved			
11	R/W	Communication time-out	For setting up the communication time-out (unit: ms) in Modbus	5,000	Yes
12	R/W	Communication delay time	For setting up the minimum interval time between every communication datum	0	Yes
13	R/W	Keep alive time	For setting up the communication time-out (unit: second) in TCP connections	30	Yes
14	R/W	I/O Enable Flag	High byte is input buffer enable flag. Low byte is output buffer enable flag. The flag will be cleared when data was sent.	0	No
15	R/W	IP Index	Destination IP index	1	Yes
16~32		Reserved			
33	R/W	Returning to default setting		0	No

Symbol "R" refers to read only; "R/W" refers to read and write.

4.2 Explanations on BR

BR#0: Model Name

Explanations:

1. Model code of IFD9507 = H' 0201.
2. You can read the model code in the program to see if the extension module exists

BR#1: Firmware Version

Explanations:

The firmware version of IFD9507 is displayed in hex, e.g. H'0100 indicates version V1.00.

BR#2: Release Date of the Version

Explanations:

Displaying the date in decimal form. 10,000s digit and 1,000s digit are for “month” ; 100s digit and 10s digit are for “day” . For 1s digit: 0 = morning; 1 = afternoon.

Example: 12191 indicates the version released in the afternoon of December 19.

BR#4: Communication Format

Explanations:

BR4 low byte								
	b7 ~ b4		b3		b2 ~ b1		b0	
Explanation	Reserved		Stop bit 0: 1 stop bit 1: 2 stop bits		Parity bit 00: none parity bit 01: odd parity bit 11: even parity bit		Data bit 0: 7 data bits 1: 8 data bits	
Content	0000 (0)	7-N-1	0011 (3)	8-O-1	1000 (8)	7-N-2	1011 (B)	8-O-2
	0001 (1)	8-N-1	0110 (6)	7-E-1	1001 (9)	8-N-2	1110 (E)	7-E-2
	0010 (2)	7-O-1	0111 (7)	8-E-1	1010 (A)	7-O-2	1111 (F)	8-E-2
BR4 high byte								
	b7	B6 ~ b4	B3	b2		b1		b0
Explanation	RS-485 User Define 0: Disable 1: Enable	Reserved	RS-232 User Define 0: Disable 1: Enable	COM2 RS-485 setting 0: Serial Master Ethernet Server 1: Serial Slave Ethernet Client		COM1 RS-232 setting 0: Delta Configuration 1: Modbus		Mode 0: ASCII 1: RTU
Content	00000000 (0)	Disable	Disable	Serial Master		Delta configuration		ASCII
	00000001 (1)	Disable	Disable	Serial Master		Delta configuration		RTU
	00000010 (2)	Disable	Disable	Serial Master		Modbus		ASCII
	00000011 (3)	Disable	Disable	Serial Master		Modbus		RTU
	00000100 (4)	Disable	Disable	Serial Slave		Delta configuration		ASCII
	00000101 (5)	Disable	Disable	Serial Slave		Delta configuration		RTU
	00000110 (6)	Disable	Disable	Serial Slave		Modbus		ASCII
	00000111 (7)	Disable	Disable	Serial Slave		Modbus		RTU
	00001000 (8)	Disable	Enable	Serial Master		Delta configuration		ASCII
	:	:	:	:		:		:
	10000111 (135)	Enable	Disable	Serial Slave		Modbus		RTU
	10001000 (136)	Enable	Enable	Serial Master		Delta configuration		ASCII
	10001001 (137)	Enable	Enable	Serial Master		Delta configuration		RTU
	10001010 (138)	Enable	Enable	Serial Master		Modbus		ASCII
	10001011 (139)	Enable	Enable	Serial Master		Modbus		RTU
	10001100 (140)	Enable	Enable	Serial Slave		Delta configuration		ASCII
10001101 (141)	Enable	Enable	Serial Slave		Delta configuration		RTU	
10001110 (142)	Enable	Enable	Serial Slave		Modbus		ASCII	
10001111 (143)	Enable	Enable	Serial Slave		Modbus		RTU	

BR#5: Baud Rate

Explanations:

BR#5 low byte for baud rate of COM1							
Content	Communication interface	Explanation					
	RS-232	Data	Baud rate (bps)	Data	Baud rate (bps)	Data	Baud rate (bps)
0x01		110	0x06	2,400	0x0B	57,600	
0x02		150	0x07	4,800	0x0C	115,200	
0x03		300	0x08	9,600			
0x04		600	0x09	19,200			
0x05		1,200	0x0A	38,400			
BR#5 high byte for baud rate of COM2							
Content	RS-485 same as low byte						

BR#6: Address

Explanations:

For filling in or reading the Modbus address. The address will be displayed in the message display after being set up.

BR#7: Number of DI/DO Points

Explanations:

Read the number of DI/DO points from BR#7.

BR#9: Error Code

Explanations:

Error code = 0 refers to no error occurring.

Code	Indication	How to correct
01 ~ F7	Node address of the scan module (when operating normally)	--
F0	Returning to default setting	--
F1	IFD9507 being powered	--
F2	Power supply in low voltage	Check if the power supply of the module works normally.
F3	Internal memory detection error	1. Re-power IFD9507. If the error still exists, try step 2. 2. Reset IFD9507. If the error still exists, send the module back to the factory for repair.
F4	Internal error. Manufacturing error.	1. Re-power IFD9507. If the error still exists, try step 2. 2. Reset IFD9507. If the error still exists, send the module back to the factory for repair.
F5	Network connection error	Check if IFD9507 is connected normally to the network.
F6	Full number of devices connected in the network.	Check if the number is too much.
F7	UART setting error.	Check if the RS-485, RS-232 communication format is correct.
E1	Alarm 1 triggered	Check alarm input point 1.

Code	Indication	How to correct
E2	Alarm 2 triggered	Check alarm input point 2.
E3	Alarm 3 triggered	Check alarm input point 3.
04	CRC error	1. Check if IFD9507 is normally connected to RS-485. 2. Make sure the transmission speed of IFD9507 is consistent with that of other nodes on the network.
0B	No response from the station	1. Check if IFD9507 is normally connected to RS-485. 2. Make sure the transmission speed of IFD9507 is consistent with that of other nodes on the network.

BR#11: Communication Time-out (ms)

Explanations:

or setting up the communication time-out in Modbus. Default = 5,000ms. For example, if you wish to set up the communication time-out as 7 seconds manually, write 7,000 into BR11.

BR#12: Communication Delay Time (ms)

Explanations:

For setting up the minimum interval time between every Modbus communication datum. Default = 0ms. For example, if you wish to set up the communication delay time as 100ms manually, write 100 into BR12.

BR#13: Keep Alive Time (s)

Explanations:

For setting up the communication time-out in TCP connections. Default = 30s. For example, if you wish to set up the communication time-out as 7 seconds manually, write 7 into BR13.

BR14: I/O Enable Flag

Explanations:

Setting up input buffer and output buffer enable or not. Default = 0. Setting high byte to 1 can enable input buffer and setting low byte to 1 can enable output buffer.

BR15: IP index

Explanations:

Destination IP index is used in a TCP connection. Default = 1. In delta DCISoft, there are 4 items can be set therefore the index is 1 to 4. User can select one of items to connect with others Ethernet/IP device.

BR#33: Returning to Default Setting

Explanations:

IFD9507 will return to default setting when "1" is written into BR#33. BR#33 will be cleared to "0" automatically after the returning.

4.3 Alarm Registers (AL) in IFD9507

AL#	Attribute	Content	Explanation	Default	Latched
0	R/W	Alarm point 1		0	Yes

AL#	Attribute	Content	Explanation	Default	Latched
1	R/W	Alarm point 2		0	Yes
2	R/W	Alarm point 3		0	Yes

Symbol "R" refer to read only; "R/W" refers to read and write.

AL#0: Alarm Point 1

Explanations:

You can designate one RX extension point as the alarm point by setting up the AL register in IFD9507. When the alarm point is triggered, IFD9507 will execute its corresponding function. When b15 of AL0 is set as "1", the Gateway will execute the event immediately. When RX point is triggered, the Gateway will only execute the triggered event once.

Device		Function	Setting	Attribute	Default	Latched	
AL#0	b15	Enabling the function	b15 = 1: Enabling b15 = 0: Disabling	R/W	0	Yes	
	b4 ~ b14	Reserved		R/W	0	No	
	b2 ~ b3	Type of event enabled when RX alarm point is triggered		b3 b2	R/W	0	Yes
			Reserved	0 0			
			Trigger E-Mail	0 1			
			Reserved	1 0			
		Reserved	1 1				
			The setting will be invalid when the alarm function is being executed.				
b1	Reserved	Reserved					
b0	Condition for triggering RX	b0 = 0: Triggered when RX input point is low b0 = 1: Triggered when RX input point is high		R/W	0	Yes	

AL#1: Alarm Output 2

Explanations:

The settings for AL#1 are the same as those in AL#0.

AL#2: Alarm Output 3

Explanations:

The settings for AL#2 are the same as those in AL#0.

4.4 In buffer registers (IN) in IFD9507

IN#	Attribute	Content	Explanation	Default	Latched
0~255	R/W	Data input buffer	Ethernet/IP input data	0	No

Symbol "R" refers to read only; "R/W" refers to read and write.

Explanations:

The input data was sent to Ethernet.

4.5 Out buffer registers (OUT) in IFD9507

OUT#	Attribute	Content	Explanation	Default	Latched
0~255	R	Data output buffer		0	No

Symbol "R" refers to read only; "R/W" refers to read and write.

Explanations:

The output data was sent to RS-485.

5 Monitoring Functions

5.1 Monitor Bit Registers (MB)

MB#	Attribute	Content	Explanation	Default	Latched
0	R/W	Number of devices monitored	Cache mode normally enabled (b15=1), monitoring data in max. 16 slaves.	0	Yes
1	R/W	No. of station monitored	No. of the station to be monitored	0	Yes
2	R/W	Address of the device monitored	Recording the address of the device monitored.	0	Yes
3 ~ 32	R/W	No. of station monitored, address of the device monitored	No. of the station to be monitored; recording the address of the device monitored.	0	Yes
33 ~ 200	R/W	Reserved			
201	R	Monitored value	Every MB records the value in the 16-bit device.	0	No
202 ~ 213	R	Reserved			
214	R	Monitored status	Every MB records the status in the 16-bit device. 1 = normal; 0 = abnormal	0	No

Symbol "R" refer to read only; "R/W" refers to read and write.

MB#0: Number of Devices Monitored

Explanations:

For setting up the number of devices to be monitored. Max. data in 16 slaves can be monitored.

b15 is read only (Default =1: normally enabled cache mode)

MB# (Odd Number): No. of Station Monitored

Explanations:

MB#1, MB#3, MB#5...MB#33 are for setting up the station No. (0 ~ 255) to be monitored.

MB# (Even Number): Address of Device Monitored

Explanations:

MB#2, MB#4, MB#6...MB#34 are for setting up the address of the device to be monitored.

MB#201: Monitored Value

Explanations:

Every MB records the values in the 16-bit device.

b15	b14	b13	b12	b11	b10	b9	b8	b7	b6	b5	b4	b3	b2	b1	b0
Device 16	Device 15	Device 14	Device 13	Device 12	Device 11	Device 10	Device 9	Device 8	Device 7	Device 6	Device 5	Device 4	Device 3	Device 2	Device 1

MB#214: Monitored Status

Explanations:

Every MB records the status in the 16-bit device. 1 = normal; 0 = abnormal.

b15	b14	b13	b12	b11	b10	b9	b8	b7	b6	b5	b4	b3	b2	b1	b0
Device 16	Device 15	Device 14	Device 13	Device 12	Device 11	Device 10	Device 9	Device 8	Device 7	Device 6	Device 5	Device 4	Device 3	Device 2	Device 1

5.2 Monitor Word Registers (MW)

MW#	Attribute	Content	Explanation	Default	Latched
0	R/W	Number of devices monitored	Cache mode normally enabled (b15=1), monitoring data in max. 16 slaves.	0	YES
1	R/W	No. of station monitored	No. of the station to be monitored	0	YES
2	R/W	Address of the device monitored	Recording the address of the device monitored	0	YES
3 ~ 32	R/W	No. of station monitored, address of the device monitored	No. of the station to be monitored; recording the address of the device monitored.	0	YES
33 ~ 200	R/W	Reserved			
201 ~ 216	R	Monitored value	Every MW records the monitored value in 1 register	0	NO
216 ~ 300	R	Reserved			
301	R	Monitored status	Every MW records the status in a 16-bit register. 1 = normal; 0 = abnormal	0	NO

Symbol "R" refers to read only; "R/W" refers to read and write.

MW#0: Number of Devices Monitored

Explanations:

For setting up the number of devices to be monitored. Max. data in 16 slaves can be monitored.

b15 is read only (Default =1: normally enabled cache mode)

MW# (Odd Number): No. of Station Monitored

Explanations:

MW#1, MW#3, MW#5...MW#33 are for setting up the station No. (0 ~ 255) to be monitored.

MW# (Even Number): Address of Device Monitored

Explanations:

MW32, MW34, MW#36...MW#34 are for setting up the address of the device to be monitored.

MW#201~#216: Monitored Value

Explanations:

Every MW records the values in 1 register.

MW#201	MW#202	MW#203	MW#204	MW#205	MW#206	MW#207	MW#208	MW#209	MW#210
Device 1	Device 2	Device 3	Device 4	Device 5	Device 6	Device 7	Device 8	Device 9	Device 10

MW#211	MW#212	MW#213	MW#214	MW#215	MW#216
Device 11	Device 12	Device 13	Device 14	Device 15	Device 16

MW#301: Monitored Status

Explanations:

Every MW records the status in a 16-bit register. 1 = normal; 0 = abnormal.

b15	b14	b13	b12	b11	b10	b9	b8	b7	b6	b5	b4	b3	b2	b1	b0
Device 16	Device 15	Device 14	Device 13	Device 12	Device 11	Device 10	Device 9	Device 8	Device 7	Device 6	Device 5	Device 4	Device 3	Device 2	Device 1

6 Setting up Device Address and Relay Address in Slave Mode (For Modbus TCP protocol only)

MIP#	Attribute	Content	Explanation	Default	Latched
0 ~ 50	R/W	Corresponding address	Max. 100 addresses are allowed. High byte for 1 address and low byte for 1 address.	0	Yes
50 ~ 249	R/W	Relay IP address	Total 100 IPs. Every address (1 byte) corresponds to 1 IP address (4 bytes).	0	Yes

Symbol “R” refers to read only; “R/W” refers to read and write.

MIP#0: Corresponding Address

Explanations:

The low bytes of MIP#0 are for the first address, and the high byte are for the second address, and so on.

MIP#51 ~ #52: Corresponding IP for the 1st Device Address

Explanations:

Example 1: If you wish to convert “192.168.0.1” into C0A80001 (hex), write A8C0 into MIP50 and H0100 into MIP51.

Example 2: Data in address 1 have to correspond to 192.168.0.8. Data in address 2 have to correspond to 192.168.0.6. To complete such settings, write H0102 into MIP0, H0800 into MIP50, HA8C0 into MIP51, H0600 into MIP52, and HA8C0 into MIP53.

7 Setting up Device Address and Other Network Settings in Slave Mode

Parameter	Explanation
Device address	Address of Modbus device
Relay IP address	Corresponding IP address for a device
Priority/Time Tick	Scale of time. Unit: ms
Timeout Tick	Scale of timeout
Timeout	Timeout = Time Tick × Timeout Tick (Unit: ms)

Parameter	Explanation
Multiple	Max. timeout times
Trigger	Cyclic, changing status, application object
O→T packet interval	Packet interval between originator and target
T→O packet interval	Packet interval between originator and target

8 Modbus Communication

8.1 Function Codes Supported

Function code	Explanation	Devices supported
0x02	Read discrete input	RX
0x03	Read holding register	BR, AL, MB, MW, MIP
0x06	Write single holding register	BR, AL, MB, MW, MIP
0x10	Write multiple holding register	BR, AL, MB, MW, MIP
0x17	Read/write multiple holding register	BR, AL, MB, MW, MIP

8.2 Exception Codes Supported

Exception code	Explanation
0x01	Illegal function
0x02	Illegal data addresss
0x03	Illegal data value
0x04	Slave device failure
0x0A	Gateway path unavailable
0x0B	Gateway target device failed to respond

8.3 Device Type & Device Address

Discrete input				
Device type	Modbus address (Hex)	5-digit Modbus address (Dec)	6-digit Modbus address (Dec)	Number
RX	0x0400 ~ 0x0402	11025 ~ 11027	101025 ~ 101027	3
Holding register				
Device type	Modbus address (Hex)	5-digit Modbus address (Dec)	6-digit Modbus address (Dec)	Number
BR	0x0000 ~ 0x00FF	40001 ~ 40256	400001 ~ 400256	64
AL	0x0200 ~ 0x0202	40513 ~ 40515	400513 ~ 400515	3
X	0x0400 ~ 0x0402	41025 ~ 41027	401025 ~ 401027	3
IN	0x0500 ~ 0x05FF	41281 ~ 41536	401281 ~ 401536	256
OUT	0x0600 ~ 0x06FF	41537 ~ 41791	401537 ~ 401791	256
MB	0x2000 ~ 0x20FF	48193 ~ 48448	408193 ~ 408448	256
MW	0x2200 ~ 0x23FF	48705 ~ 49216	408705 ~ 409216	512
MIP	0x2400 ~ 0x24FF	49217 ~ 49471	409217 ~ 409471	256

9 Ethernet/IP Communication

9.1 Service code supported

Service Code	Object	Service	Description
0x01	ID Message Router Object Assembly Object Connection Manager Object BR AL MB MW TCP Interface TCP Link	Get_Attribute_All	Returns a predefined listing of this objects attributes
0x05	ID	Reset	Invokes the Reset service for the device.
0x0E	ID Message Router Object Assembly Object Connection Manager Object BR AL MB MW TCP Interface TCP Link	Get_Attribute_Single	Return the contents of the specified attribute.
0x10	Assembly Object BR AL MB MW TCP Interface	Set_Attribute_Single	Used to modify an attribute.
0x4E	Connection Manager Object	Forward_Close	Closes a connection.
0x54	Connection Manager Object	Forward_Open	Opens a connection, maximum data size is 511 bytes.

9.2 Object supported

Object Name	Class ID Code	Instance Code	Function Description	Object Type	Attribute
ID	0x01	0x01	Identity	Attribute	Get
Message Router Object	0x02	0x01	Router Command		
Assembly Object	0x04	0x64	Assembly	GO	Set
	0x04	0x65	Input device object	GI	Get
Connection Manager Object	0x06	0x01	Connection monitor object		
RX			Digital input	Discrete input	Get
BR	0x64	0x01	Basic registers	Attribute	Get/Set
AL	0x64	0x02	Alarm function	Attribute	Get/Set
MB	0x64	0x03	Bit monitor	Attribute	Get/Set
MW	0x64	0x04	Register monitor	Attribute	Get/Set
TCP Interface	0xF5	0x01	TCP/IP Interface Object	Attribute	Get/Set

Object Name	Class ID Code	Instance Code	Function Description	Object Type	Attribute
TCP Link	0xF6	0x01	TCP/IP Link Object	Object	Get

9.3 CIP General Status Code (Reference Volume 1:CIP Common Specification Appendix B)

General Status Code (in hex)	Status Name	Description of Status
00	Success	Service was successfully performed by the object specified.
01	Connection failure	A connection related service failed along the connection path.
02	Resource unavailable	Resources needed for the object to perform the requested service were unavailable
04	Path segment error	The path segment identifier or the segment syntax was not understood by the processing node. Path processing shall stop when a path segment error is encountered.
05	Path destination unknown	The path is referencing an object class, instance or structure element that is not known or is not contained in the processing node. Path processing shall stop when a path destination unknown error is encountered.
08	Service not supported	The requested service was not implemented or was not defined for this Object Class/Instance.
09	Invalid attribute value	Invalid attribute data detected
0E	Attribute not settable	A request to modify a non-modifiable attribute was received.
13	Not enough data	The service did not supply enough data to perform the specified operation.
14	Attribute not supported	The attribute specified in the request is not supported
15	Too much data	The service supplied more data than was expected
16	Object does not exist	The object specified does not exist in the device.
20	Invalid parameter	A parameter associated with the request was invalid. This code is used when a parameter does not meet the requirements of this specification and/or the requirements defined in an Application Object Specification.
26	Path Size Invalid	The size of the path which was sent with the Service Request is either not large enough to allow the Request to be routed to an object or too much routing data was included.

9.4 Connection Manager Service Request Error Codes (Reference Volume 1:CIP Common Specification Table3-5.29)

General Status	Extended Status	Explanation and Description
0x00		Service completed successfully
0x01	0x0100	CONNECTION IN USE OR DUPLICATE FORWARD OPEN This extended status code shall be returned when an originator is trying to make a connection to a target with which the originator may have already established a connection
0x01	0x0103	TRANSPORT CLASS AND TRIGGER COMBINATION NOT SUPPORTED A transport class and trigger combination has been specified which is not supported by the target. Routers shall not fail the connection based on the transport class and trigger combination. Only targets shall return this extended status code.
0x01	0x0108	INVALID NETWORK CONNECTION PARAMETER This extended status code shall be returned as the result of specifying a connection type, connection priority, redundant owner or fixed / variable that is not supported by the target application. Only a target node shall return this extended status code.

General Status	Extended Status	Explanation and Description
0x01	0x0114	VENDOR ID OR PRODUCT CODE MISMATCH The Product Code or Vendor Id specified in the electronic key logical segment does not match the Product Code or Vendor Id of in the target device.
0x01	0x0115	PRODUCT TYPE MISMATCH The Product Type specified in the electronic key logical segment does not match the Product Type of in the target device.
0x01	0x0116	REVISION MISMATCH The major and minor revision specified in the electronic key logical segment does not correspond to a valid revision of the target device.
0x01	0x0315	INVALID SEGMENT IN CONNECTION PATH Invalid Segment Type or Segment Value in Connection Path This extended status code is the result of a device being unable to decode the connection path. This could be caused by an unrecognized path type, a segment type occurring unexpectedly, or a myriad of other problems in the connection path.

10 Setting up the Software - DCISoft

This section gives instructions on how to set up IFD9507 by DCISoft and explanations on each setup page. IFD9507 is set up by UDP port 20006; therefore, you have to be aware of the relevant settings of the firewall. See the explanations below on the software.

10.1 Setting up Communication & Searching for Modules in DCISoft

- Broadcast search

1. Open DCISoft on the PC and click on the "IP Search" icon.

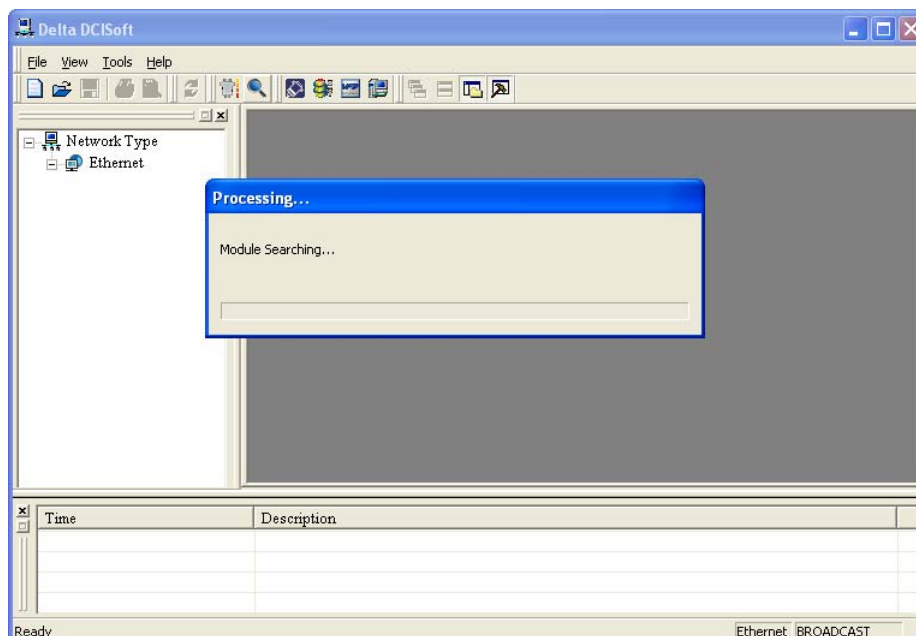

2. You will see the network modules found.

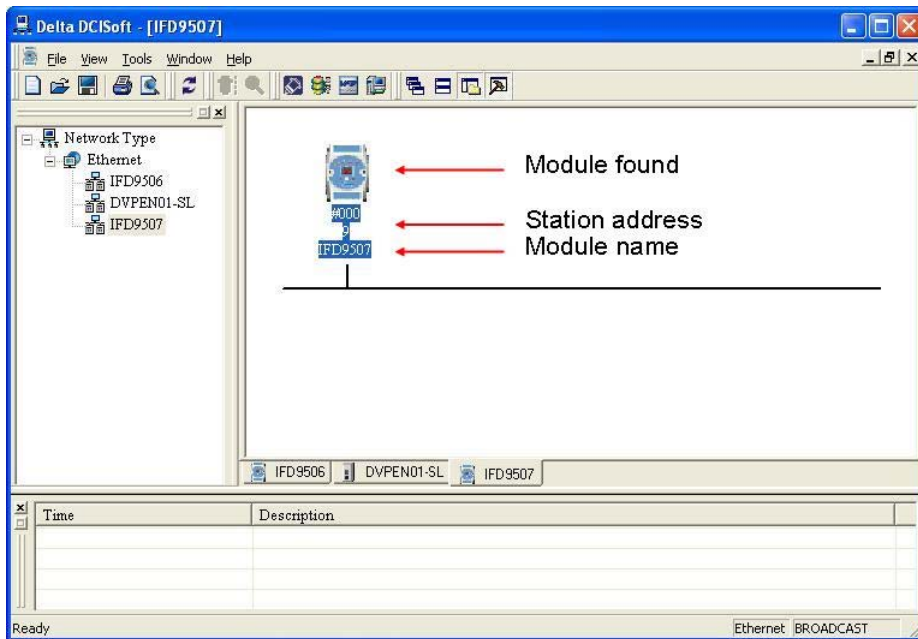

3. Double-click on the module to be set up to enter the setup page. The first page overviews the basic status of the module.

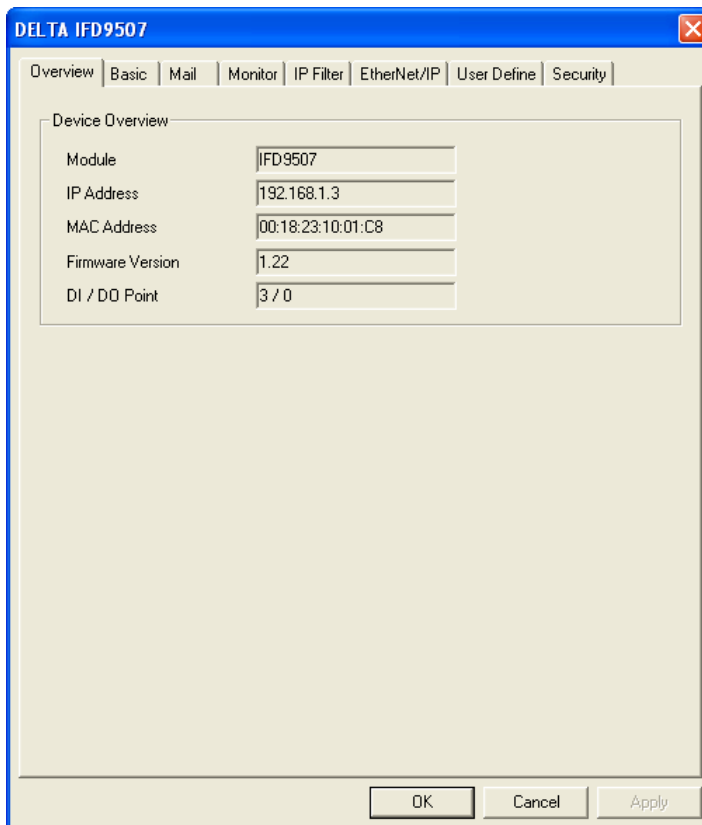

4. The next page is for basic network setup. Consult your ISP for relevant network settings. For other settings, see BR4~BR6 and BR11~BR13.

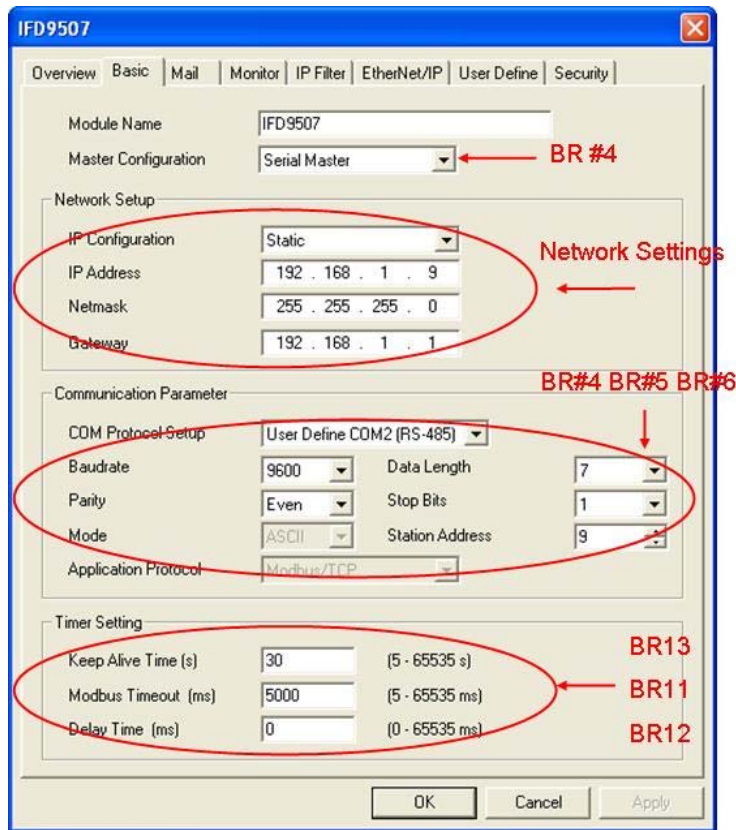

10.2 Basic Settings

The basic settings include parameters such as module name, network settings and serial communication.

■ The basics

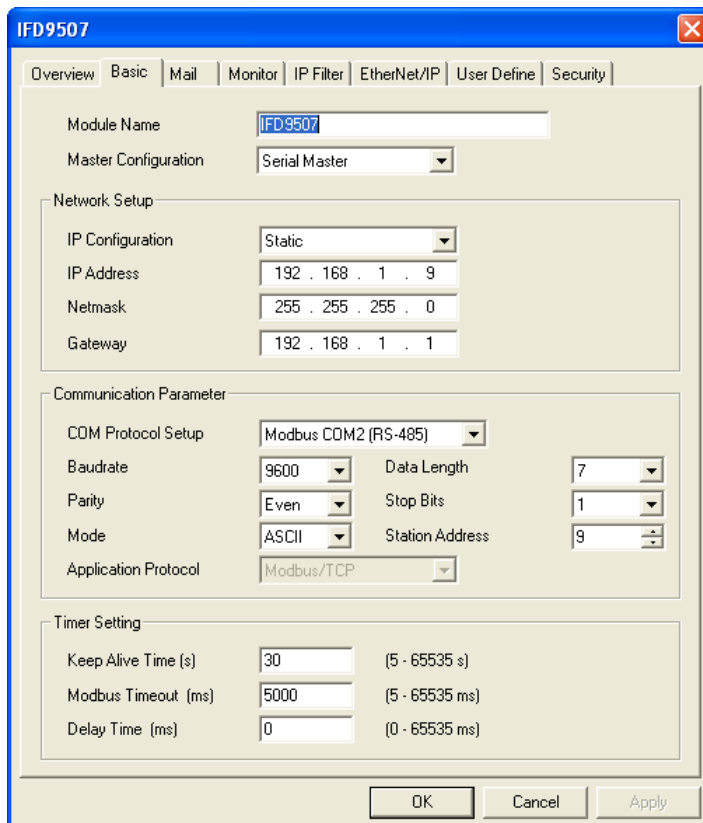

1. Module name:

There can be many IFD9507s on the network. Thus, you can set up a module name for each module to

identify the module when you need to use them.

2. Master configuration:

Open “Serial Master” mode or “Serial Slave” mode.

3. Network settings:

Enable DHCP or static IP. Consult your ISP for other relevant settings.

A. IP configuration:

There are 2 types of IP, static IP and DHCP.

Static IP: Preset or manually modified by the user.

DHCP: Automatically updated by the server. There has to be a server in the LAN.

IP	Explanation
Static	The user enters the IP address, subnet mask and gateway.
DHCP	DHCP server offers the IP address, subnet mask and gateway.

B. IP address:

IP address is the location of the equipment on the network. All equipment connected to the network has to have an IP address. Incorrect IP address will result in connection failure on the equipment or even other equipment. Ask your ISP for questions about IP address setup. The default IP for IFD9507 is 192.168.1.5.

C. Subnet mask:

Subnet mask is an important parameter for setting up the subnet, used for seeing if the destination IP and the local equipment are in the same subnet. If not, the equipment will send the packet to the gateway, and the gateway will send the packet to another subnet. Incorrect setting may cause the destination equipment unable to communication to IFD9507. To see if your setting is correct, conduct bitwise AND operations between your IP and subnet mask and destination IP and subnet mask. If the two values obtained are the same, the two IPs are in the same subnet. The default subnet mask of IFD9507 is 255.255.255.0.

D. Gateway:

Gateway is the window for two different subnets, allowing the two ends in different subnets to communicate. For example, if the LAN has to be connected to WAN, it will need a gateway to bridge the communication. The IP of the gateway has to be in the same subnet as IFD9507. The default gateway of IFD9507 is 192.168.1.254.

4. Communication parameter setting:

See how to set up BR4, BR5, and BR6.

Applicable protocol: Modbus/TCP or Ethernet/IP.

5. Timer setting:

For setting up TCP communication idle time, communication timeout and minimum delay time for every communication datum. Please refer to the settings of BR11, BR12 and BR13.

10.3 Network Settings

The first step for all the network equipment to connect to the network is to have its own IP address (Internet Protocol). The IP address is like a number for all network equipment to be identified in the network.

■ Setting up static IP of the PC

1. Enter Control Panel → Network Connection → click on “Local Area Connection”.

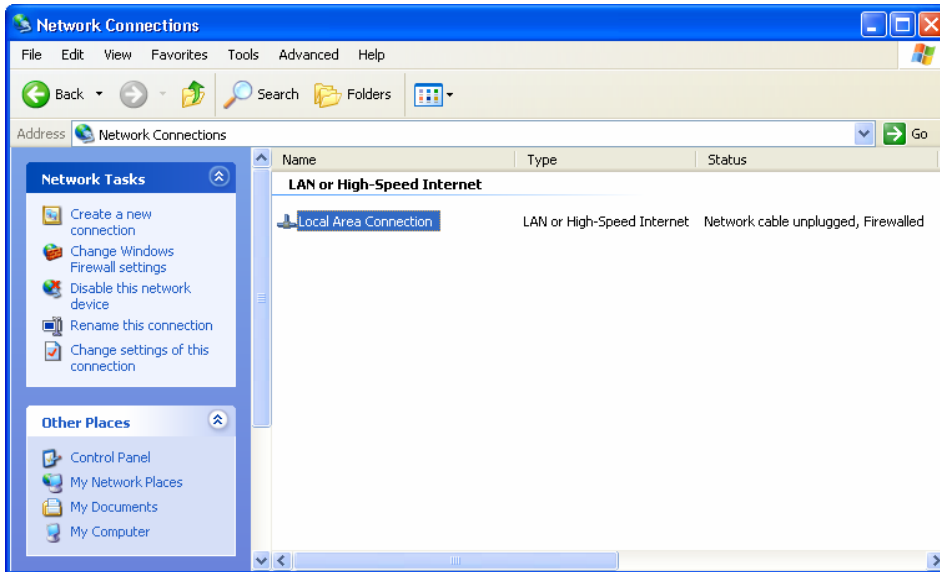

2. You will see the “Local Area Connection Status” window. Click on “Properties”.

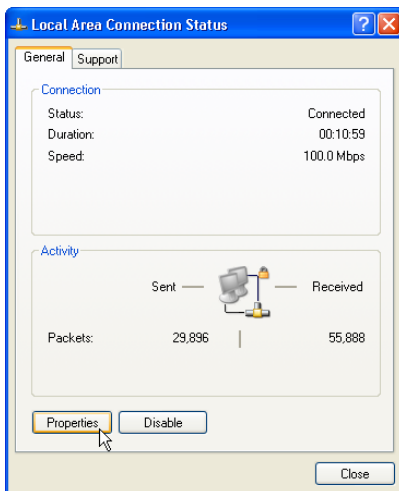

3. Click on “Internet Protocol (TCP/IP)”.

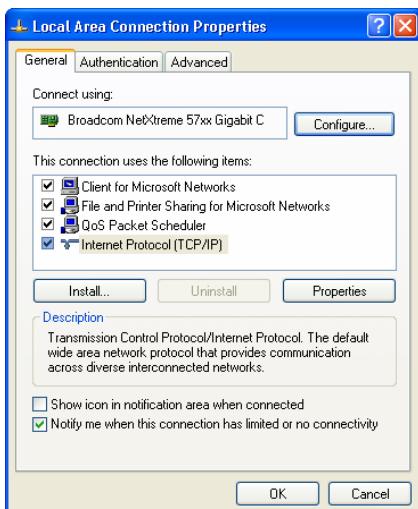

4. Enter “192.168.0.1” into IP address. Click on “OK” to complete the IP address setting of the PC.

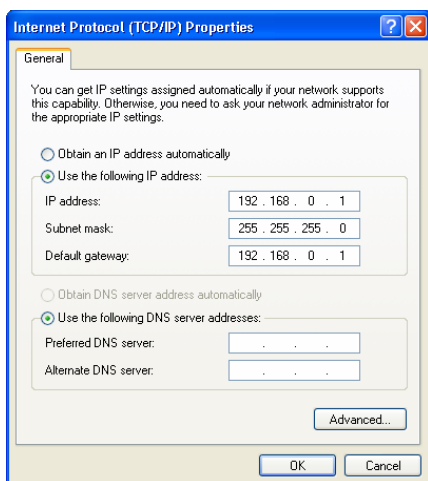

10.4 Setting up E-Mails

E-Mail is the abbreviation of electronic mail which transmits mails through the network. IFD9507 has E-Mail functions for the user to pre-save a segment of text message, which can be a descriptive message or error message, into the subject of the E-Mail. When the E-Mail is triggered, IFD9507 will send the messages to the user by E-Mail.

■ Mail settings

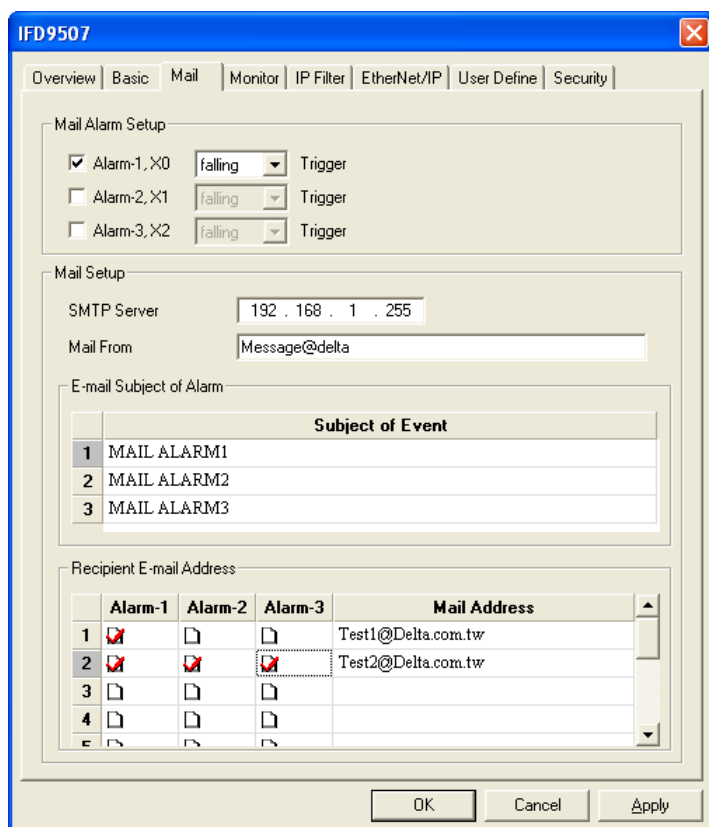

1. Mail alarm setup:

There are 3 mail alarms to be set up. Check the boxes to enable the alarms. The alarm can be triggered by "low" and "high".

2. SMTP server:

When alarm 1 is triggered, the E-Mail will first be sent to SMTP server, and the SMTP server will send it to the designated address. For example, assume there is an E-Mail to be sent to

Test@delta.com.tw, and the SMTP server is 192.168.0.1. The E-Mail will be sent to the SMTP server first, and the server will further send it to the recipient Test@delta.com.tw.

3. E-Mail of sender:

Maximum 63 English characters are allowed.

4. Subject of E-Mail:

You can enter the text message in the column, and the message will be placed in the subject of the E-Mail and sent to the recipient. IFD9507 is able to contain 1 ~ 3 E-Mail subjects (max. 63 English characters are allowed).

5. E-Mail of recipient:

One mail can be sent to 10 addresses according to the alarm settings. Every address allows max.63 English characters. For example, (see the figure above) when Alarm 1 is triggered, the E-Mail will be sent to Test1@delta.com.tw and Test2@delta.com.tw . When Alarm 2 is triggered, the E-Mail will be sent to Test2@delta.com.tw

Note:

To correctly send out E-Mails, there has to be a SMTP server in the network. When we send out an E-Mail, the mail will be sent to SMTP server first, and the server will further send the mail to the designated address.

10.5 Monitoring Settings

You can read data in designated addresses in different equipment in the network by setting up IFD9507. The data can be temporarily stored in IFD9507 for fast storing and acquisition.

■ Setting up monitoring functions

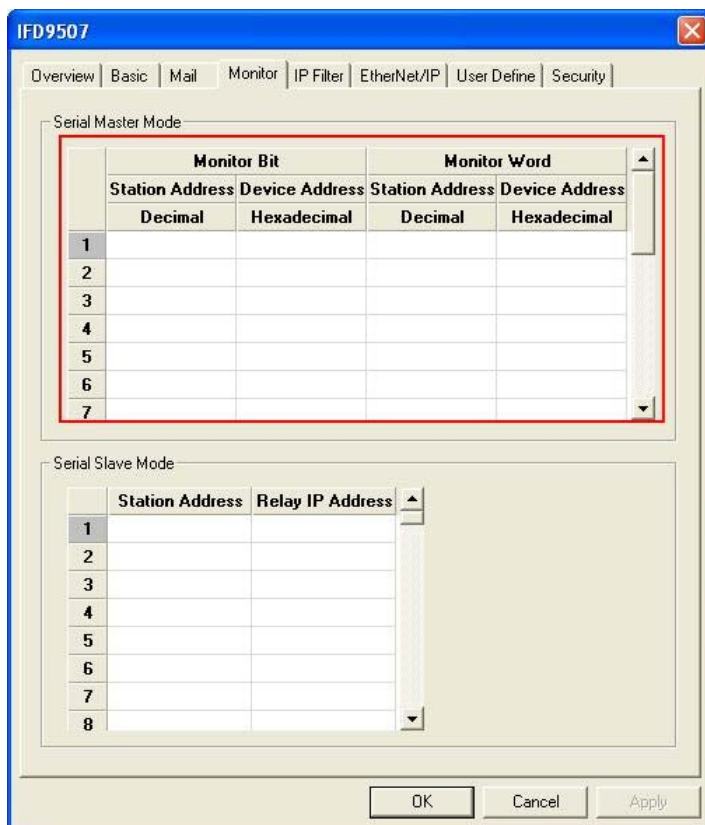

1. Monitor bit:

Device addresses for setting up the bit status of serial slave; able to read the content in the

corresponding address of the designated slave.

2. Monitor word:

Device addresses for setting up the word status of serial slave; able to read the content in the corresponding address of the designated slave.

Note:

Cache mode normally enabled, and Max. data in 16 slaves can be monitored. When the cache mode is enabled, the data you would like to read will be sent back directly from the register in IFD9507.

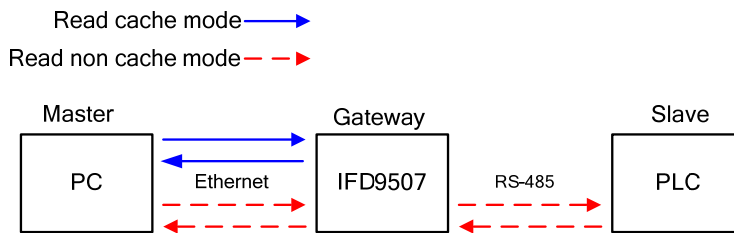

3. Serial slave mode (used when in Modbus TCP protocol):

The instruction sent from the master is received and transferred to the network. Please designate the station address and relay IP address.

Station address: slave PLC address (Gateway and PLC address cannot be the same)

Relay IP address: serial master IP

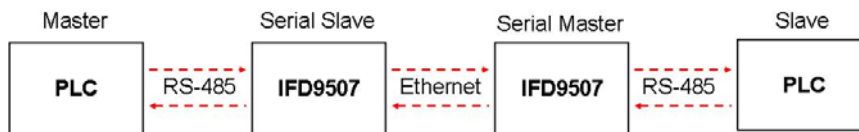

10.6 IP Filter

The IP filter is used for restricting the connection of the network in case some uncertain IP will cause errors. Only the IP set within a certain range can establish a connection. Other IPs will be rejected.

■ Setting up IP filter

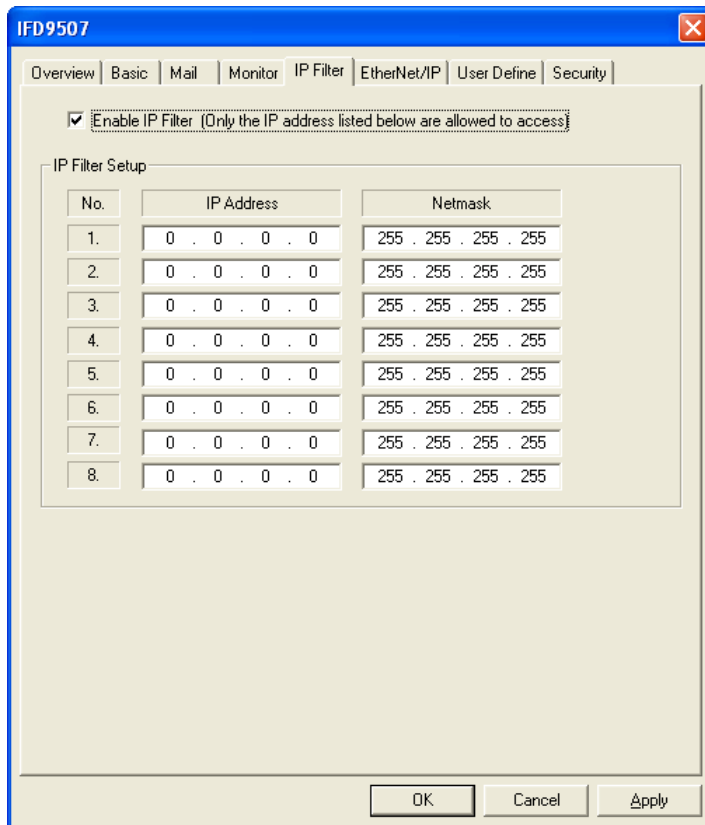

1. Enable IP filter function:

Check the box to enable IP filter.

2. IP address:

IP addresses that are allowed to establish connections. Maximum 8 IPs are allowed.

3. Netmask:

Subnet mask of the IP that is allowed to establish a connection. To see whether the subnet mask is allowed, conduct bitwise AND operation between the allowed IP and subnet mask and destination IP and subnet mask. If the two values obtained are the same, the subnet mask is allowed by the network. For example, assume the IP is 192.168.0.1 and subnet mask 255.255.255.255, the only IP allowed to establish a connection will be 192.168.0.1. If the subnet mask is 255.255.255.0, the IPs allowed to establish connections will become 192.168.0.0 ~ 192.168.0.255.

10.7 Ethernet/IP settings

Ethernet/IP parameters are used for a connection.

- Setting Ethernet/IP parameters

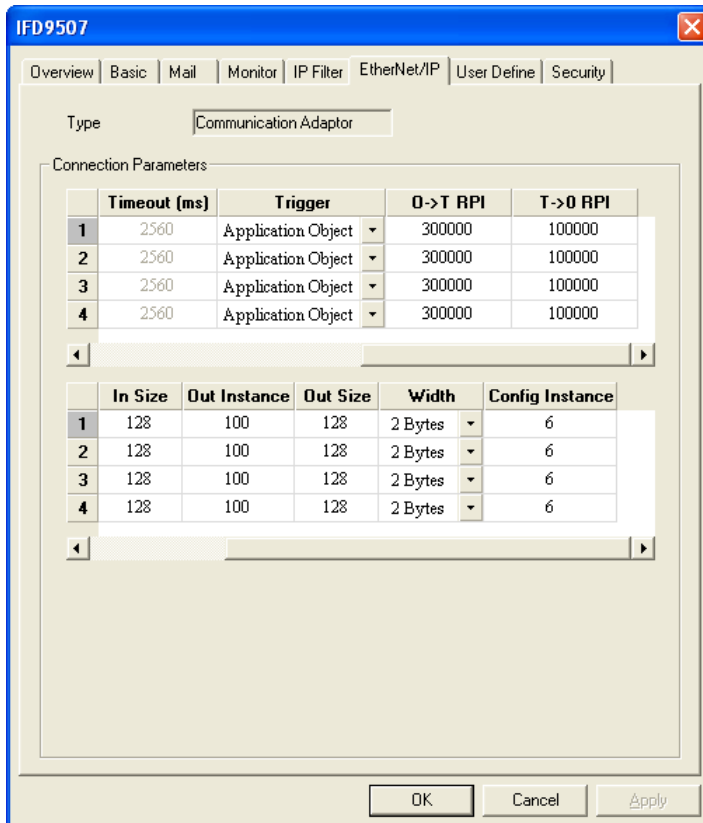
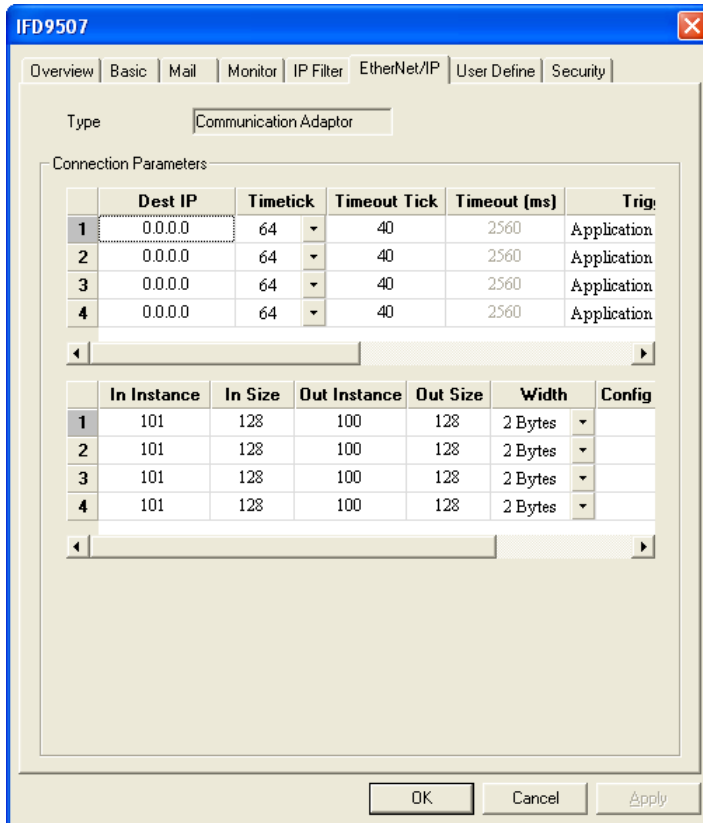

1. Dest IP
This is Destination IP address.
2. Timeout (ms)
Timetick * Timeout tick = Timeout
※ Available time tick: 20 ~ 215

※ Max. Timeout tick: 255

3. Trigger

There are three trigger types. The cyclic used to describe event that repeat in regular. Production occurs when a change of state is detected by application object. The Application object used to provide the run time exchange of messages across network.

4. O→T RPI

Originator to target requested packet interval.

When the trigger occurs, the packet is sent to the target within the set interval time.

5. T→O RPI

Target to originator requested packet interval.

When the trigger occurs, the packet is sent to the source within the set interval time.

6. In Instance

Target input buffer Instance. Range: 1 ~ 65,535.

7. In Size

Target input buffer size. Range: 0 ~ 256.

8. Out Instance

Target output buffer instance. Range: 1 ~ 65,535.

9. Out Size

Target output buffer size. Range: 0 ~ 256.

10. Width

Data width

11. Config Instance

Configuration instance. Range: 1 ~ 65,535.

10.8 User Defined Settings

When you set up user-defined communication protocol for IFD9507, please set up the following parameters.

- Setting up communication parameter between RS-232/RS-485 serial master and serial slave

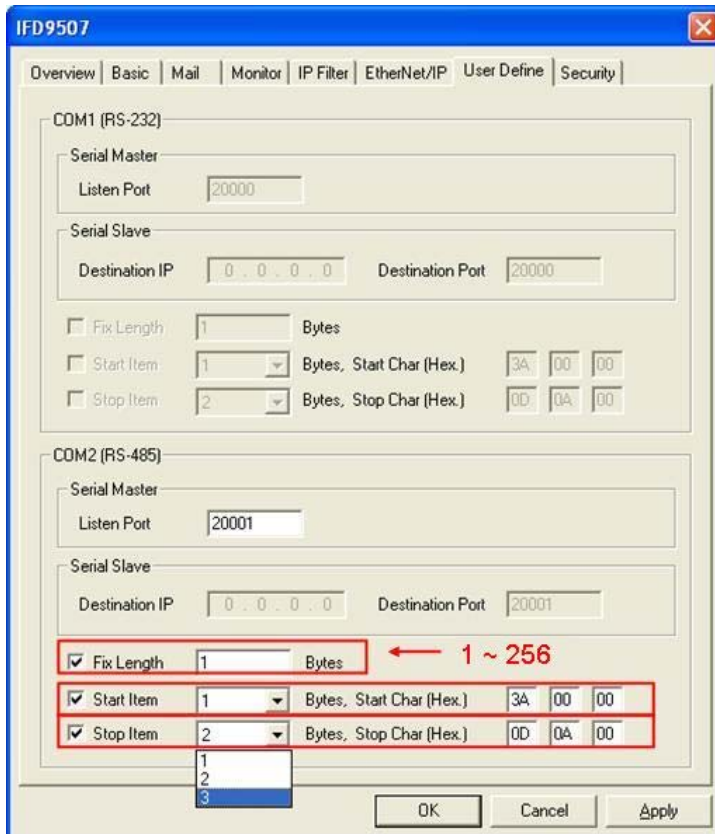
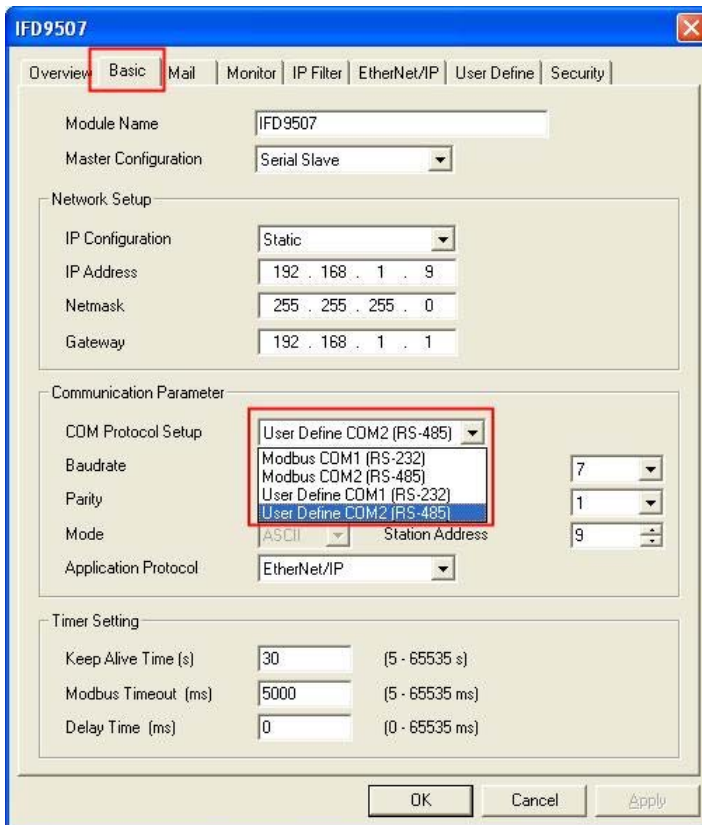

1. Listen Port/Destination IP:
Range: 1,024 ~ 65,535
2. Fix Length:
Length of the packet to be transmitted. Unit: byte
3. Start Item:

1 ~ 3 bytes of characters as the start of a packet.

4. Stop Item:

1 ~ 3 bytes of characters as the stop of a packet.

10.9 Virtual COM

Virtual COM converts the data transmitted to RS-232 to Ethernet.

- Select "User Define COM".

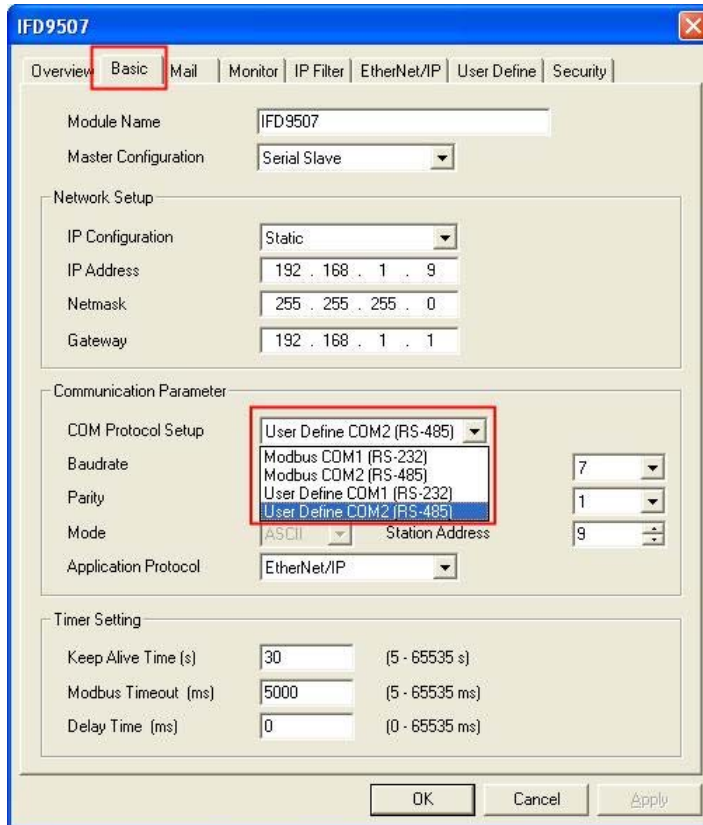

- Switch to "User Define" page and select "Listen Port".

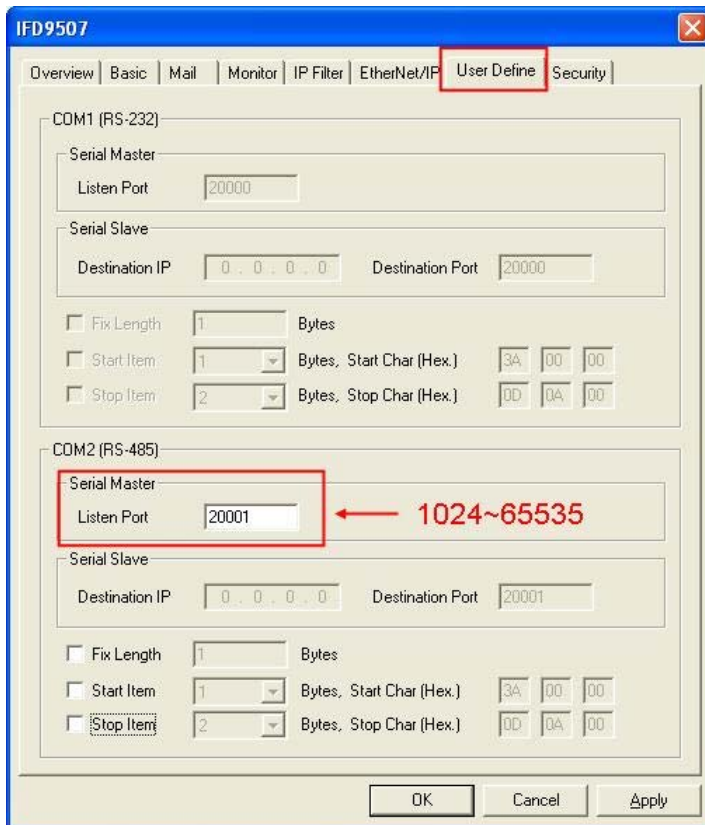

- Open Virtual COM setup page.

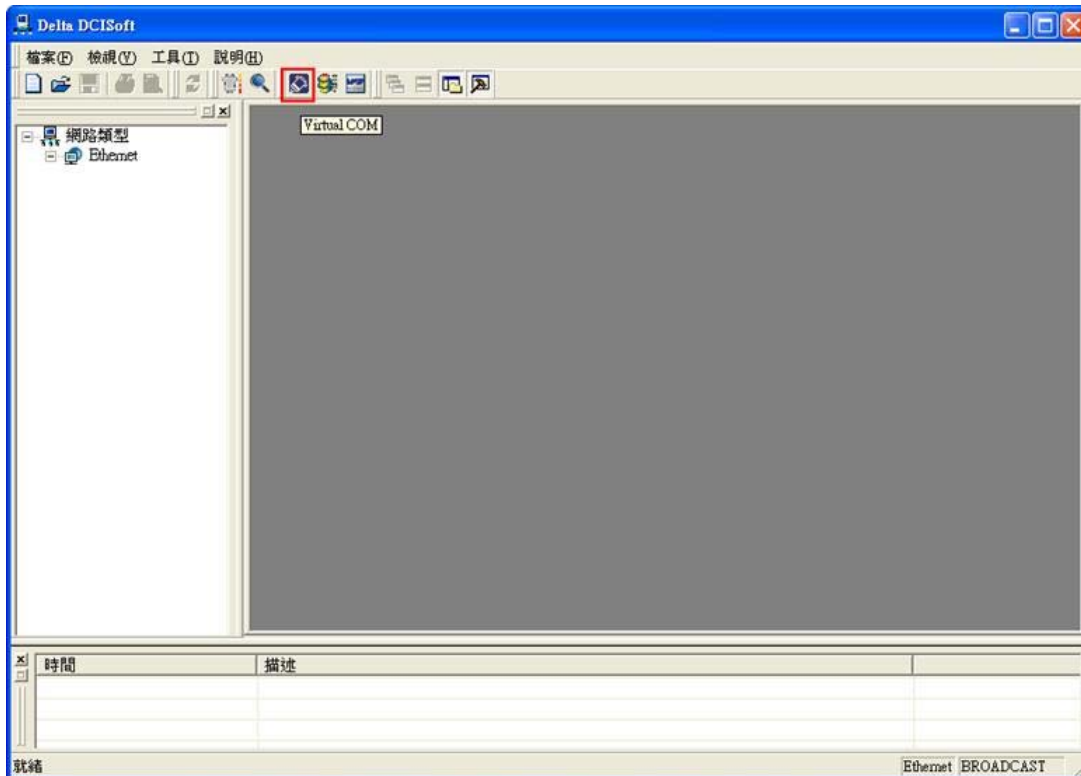

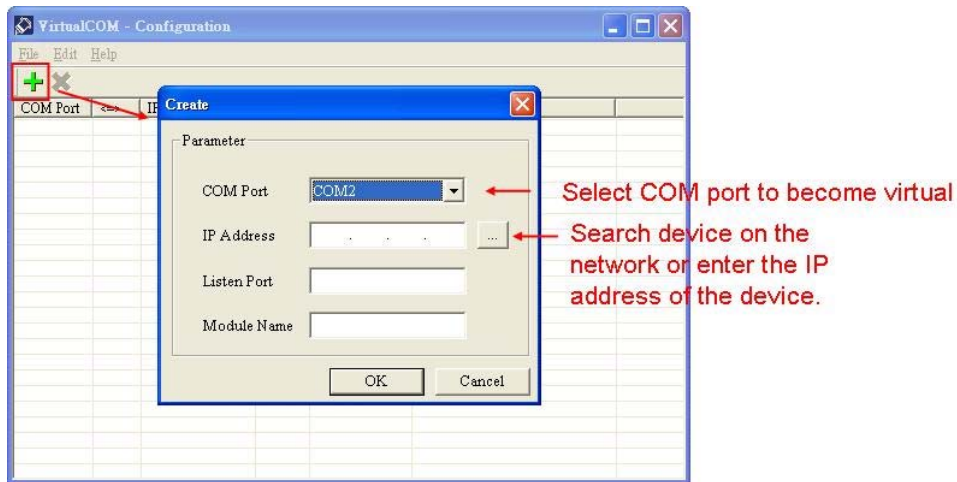

- Press “OK”, and you will see all the devices connected on the network.

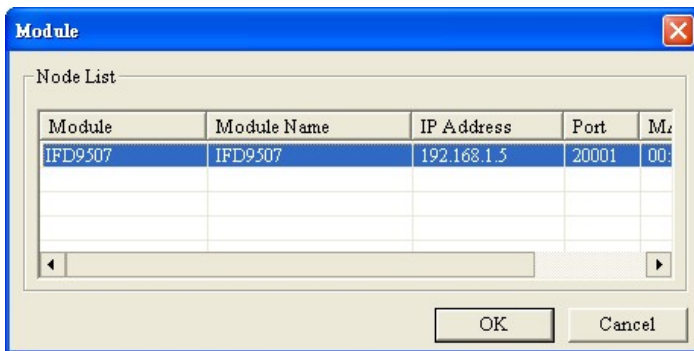

- Select the module you need and press “OK”. Relevant information of the device will be imported automatically. Press “OK” to complete the setup.

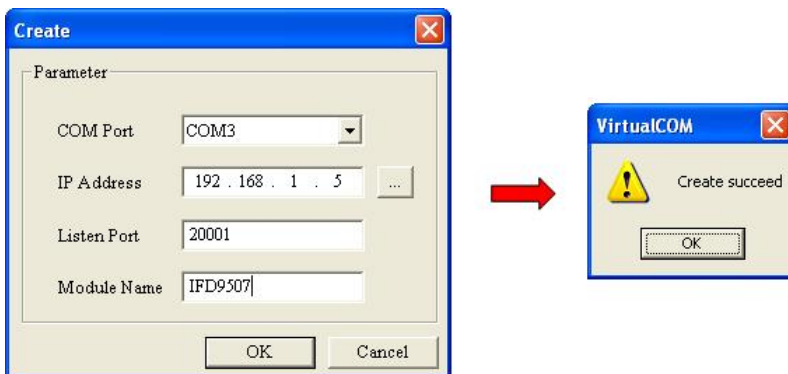

- Once the setup is successful, you can see the virtual COM you set in the Device Manager.

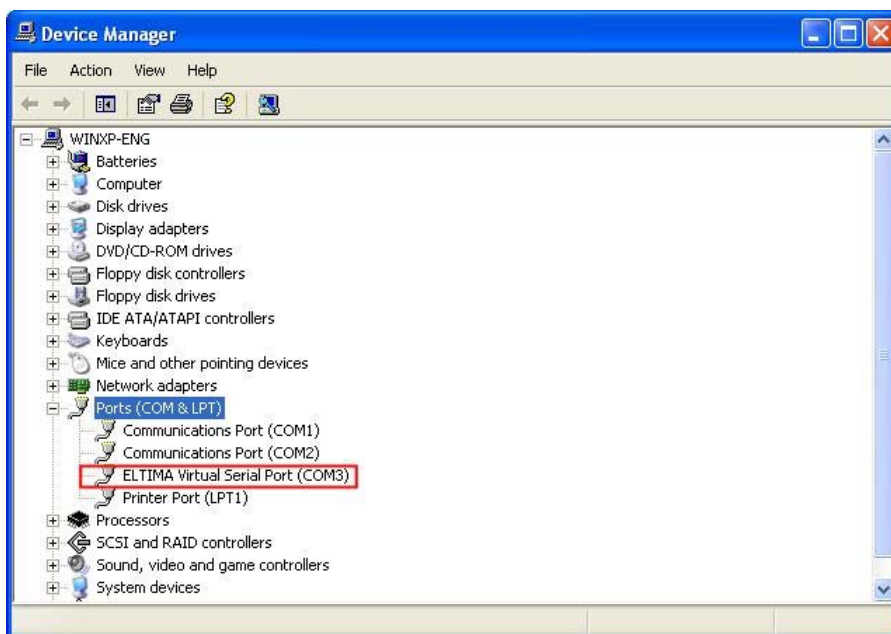

10.10 Security Settings

To prevent the set values in IFD9507 from being modified, you can set up passwords to lock the settings in IFD9507.

■ Setting up password

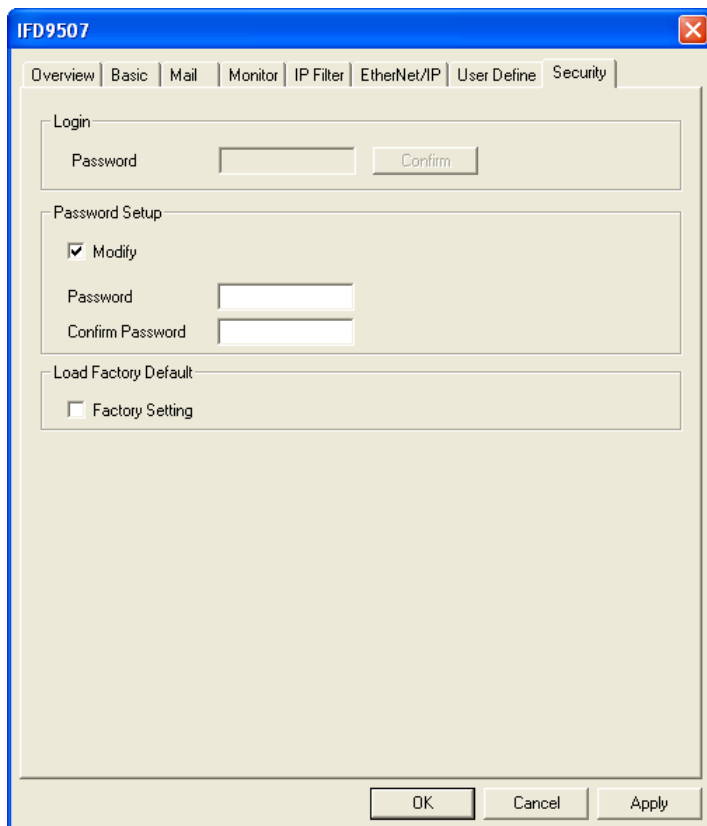

1. Password setup:
Check the "Modify" box to set up the password.
2. Confirm password:
Enter the new password again.
3. See "12.1 Application Examples" for more details.

Note:

Once the password is locked, all the pages cannot be set up unless you unlock the password. However, if you set up IFD9507 by RS-232, you can return the setting to default one whether the password is locked or not. For example, if you have locked IFD9507 but forget the password, you have to return IFD9507 to default setting by RS-232, and all the settings will return to default ones.

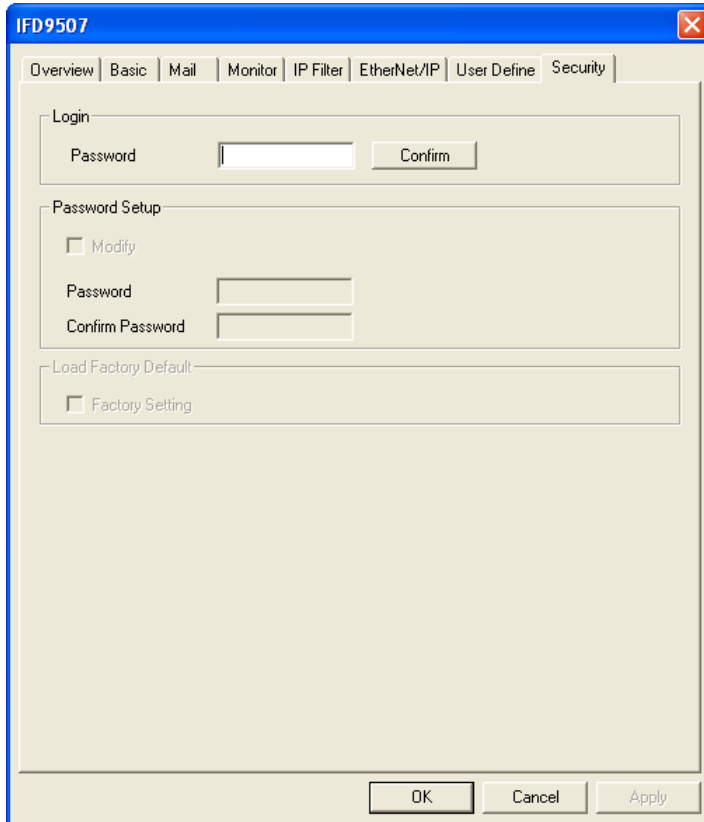
■ Login passwordThe image shows a screenshot of the IFD9507 configuration software window, specifically the Security tab. The window has a blue title bar with the text 'IFD9507' and a close button. Below the title bar is a menu bar with tabs: Overview, Basic, Mail, Monitor, IP Filter, EtherNet/IP, User Define, and Security. The Security tab is active. The main area is divided into three sections: 'Login' with a 'Password' input field and a 'Confirm' button; 'Password Setup' with a 'Modify' checkbox, a 'Password' input field, and a 'Confirm Password' input field; and 'Load Factory Default' with a 'Factory Setting' checkbox. At the bottom of the window are three buttons: 'OK', 'Cancel', and 'Apply'.**Password:**

Enter the password to unlock the editing function for other pages.

10.11 Returning to Default Settings

If you need to clear all the settings after many modifications on the settings and return the settings to default ones, check the “Factory Setting” box.

■ Returning to default settings

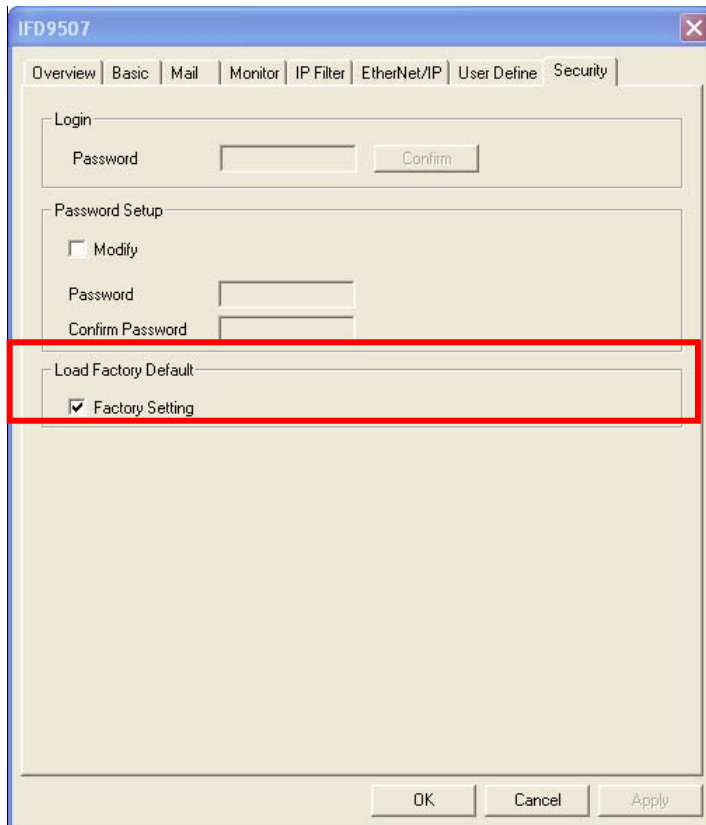

Returning to default setting:

Check "Factory Setting" box and click on "Yes".

Note:

If you set up IFD9507 by RS-232, you can return to settings to default ones whether the password is locked or not. It will take approximately 10 seconds to return to default settings, so DO NOT switch off the power within the 10 seconds. Besides, you can also press "Reset" button for 2 seconds to return to default settings.

11 Setting up Configuration by Homepage

This section gives instructions on how to set up IFD9507 by homepage and explanations on each configuration page. IFD9507 is set up by UDP port 20006; therefore, you have to be aware of the relevant settings of the firewall. See the explanations below on the homepage.

11.1 Webpage connection

- Enabling webpage function

1. Open IE, and enter the IP address of IFD9507 into the address column.
2. See below for the setup page offered by the webpage. Preview all the information in the column on the left hand side.

The screenshot shows the configuration interface for the IFD9507 module. The 'Basic' tab is active, displaying the following information:

- Module:** IFD9507
- IP Address:** 192.168.1.9
- MAC Address:** 00:18:23:10:03:E9
- Firmware Version:** 1.40

The configuration fields are as follows:

- Module Name:** IFD9507
- Module Configuration:** Serial Master
- Network Setup:**
 - IP Configuration: Static
 - IP Address: 192.168.1.9
 - Netmask: 255.255.255.0
 - Gateway: 192.168.1.1
- Communication Parameter:**
 - COM Protocol Setup: Modbus COM2 (RS-485)
 - Baudrate: 9600
 - Data Length: 7
 - Parity: E
 - Stop Bit: 1
 - Mode: ASCII
 - Station Address: 9
 - Application Protocol: EtherNet/IP
- Timer Setting:**
 - Keep Alive Time(s): 30 (5 ~ 65535 s)
 - Modbus Timeout (ms): 5000 (5 ~ 65535 ms)
 - Delay Time (ms): 0 (0 ~ 65535 ms)

An 'Apply' button is located at the bottom right of the configuration area.

11.2 Basic settings

The basic settings include parameters as module name, network settings and series communication. Please consult your Internet service provider for relevant network settings. For other settings, please refer to BR4 ~ BR6 and BR11 ~ BR13.

- The basics

The screenshot shows the configuration interface for the IFD9507 module. The 'Basic' tab is selected, displaying the following information:

- Module:** IFD9507
- IP Address:** 192.168.1.9
- MAC Address:** 00:18:23:10:03:E9
- Firmware Version:** 1.40

The 'Network Setup' section is highlighted with a red box and labeled 'Network settings'. It includes:

- IP Configuration:** Static
- IP Address:** 192.168.1.9
- Netmask:** 255.255.255.0
- Gateway:** 192.168.1.1

The 'Communication Parameter' section is highlighted with a red box and labeled 'BR4 BR5 BR6'. It includes:

- COM Protocol Setup:** Modbus COM2 (RS-485)
- Baudrate:** 9600
- Data Length:** 7
- Parity:** E
- Stop Bit:** 1
- Mode:** ASCII
- Station Address:** 9
- Application Protocol:** EtherNet/IP

The 'Timer Setting' section is highlighted with a red box and labeled 'BR13 BR11 BR12'. It includes:

- Keep Alive Time(s):** 30 (5 ~ 65535 s)
- Modbus Timeout (ms):** 5000 (5 ~ 65535 ms)
- Delay Time (ms):** 0 (0 ~ 65535 ms)

An 'Apply' button is located at the bottom right of the interface.

See 10.2 for how to set up.

11.3 Setting up E-Mails

Email is the abbreviation of electronic mail which transmits mails through the network. IFD9507 has E-Mail functions for the user to pre-save a segment of text messages, which can be a descriptive message or error message, into the subject of the E-Mail. When the E-Mail is triggered, IFD9507 will send the messages to the user by E-Mail.

■ Mail settings

1. Mail alarm setup:

There are 3 mail alarms to be setup. Check the boxes to enable the alarms. The alarms can be triggered by “falling” or “rising” .

2. See 10.4 for how to set up SMTP server/Mail From/E-mail Subject of Event/Recipient E-Mail Address columns.

11.4 IP filter

The IP filter is used for restricting the connection of the network in case some uncertain IP will cause errors. Only the IP set within a certain range can establish a connection. Other IPs will be rejected.

■ Setting up IP filter

See 10.6 for how to set up.

11.5 Security Settings

To prevent the set values in IFD9507 being modified, you can set up passwords to lock the settings in IFD9507.

■ Setting up IFD9507 password

The screenshot shows the configuration web interface for the IFD9507 module. The 'Security' tab is selected. On the left, a sidebar lists the module name (IFD9507), IP Address (192.168.1.9), MAC Address (00:18:23:10:03:E9), and Firmware Version (1.40). The main content area is divided into two sections: 'Password Setup' and 'Load Factory Default'. The 'Password Setup' section is highlighted with a red box and contains two input fields: 'Password' and 'Confirm Password'. The 'Load Factory Default' section contains a checkbox labeled 'Factory Setting' and an 'Apply' button.

1. Password setup:

Maximum 4 characters are allowed. Leave the column “blank” to disable the password protection function.

2. Confirming password:

Enter the new password again.

Note:

Once the password is locked, all the pages cannot be set up unless you unlock the password. However, if you set up IFD9507 by RS-232, you can return the setting to default one whether the password is locked or not. For example, if you have locked IFD9507 but forget the password, you have to return IFD9507 to default setting by RS-232, and all the settings will return to default ones.

■ Login password

This screenshot is identical to the one above, showing the 'Security' tab configuration. The 'Password Setup' section is highlighted with a blue box. It contains two input fields: 'Password' and 'Confirm Password'. Below it is the 'Load Factory Default' section with a 'Factory Setting' checkbox and an 'Apply' button.

1. Refreshing webpage:
Once IFD9506 is locked by a password, please click on “Refresh” on the webpage toolbar to display the password login page.
2. Setting up password:
Enter the password to enable the editing function on other pages.

11.6 Returning to default setting

If you need to clear all the settings after many modifications on the settings and return the settings to default ones, check the “Factory Setting” box.

- Returning to default setting

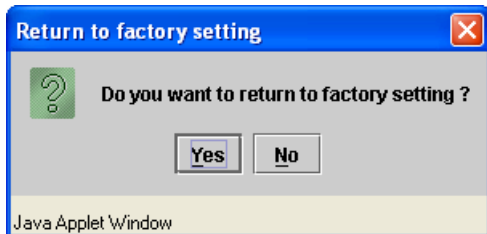
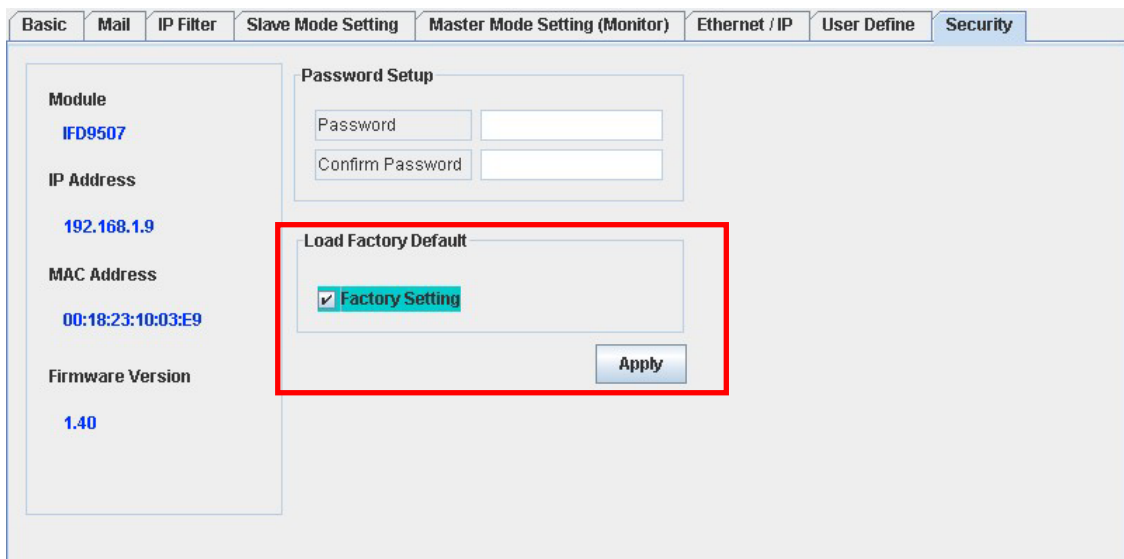

Returning to default setting:
Check “Factory Setting” box and click on “Yes”.

Note:

If you set up IFD9507 by RS-232, you can return to settings to default ones whether the password is locked or not. It will take approximately 10 seconds to return to default settings, so DO NOT switch off the power within the 10 seconds. Besides, you can also press “Reset” button for 2 seconds to return to default settings.

11.7 Monitoring settings

You can read data in designated addresses in different equipment in the network by setting up IFD9507. The data can be temporarily stored in IFD9507 for fast storing and acquisition.

- Setting up Master Mode monitoring functions

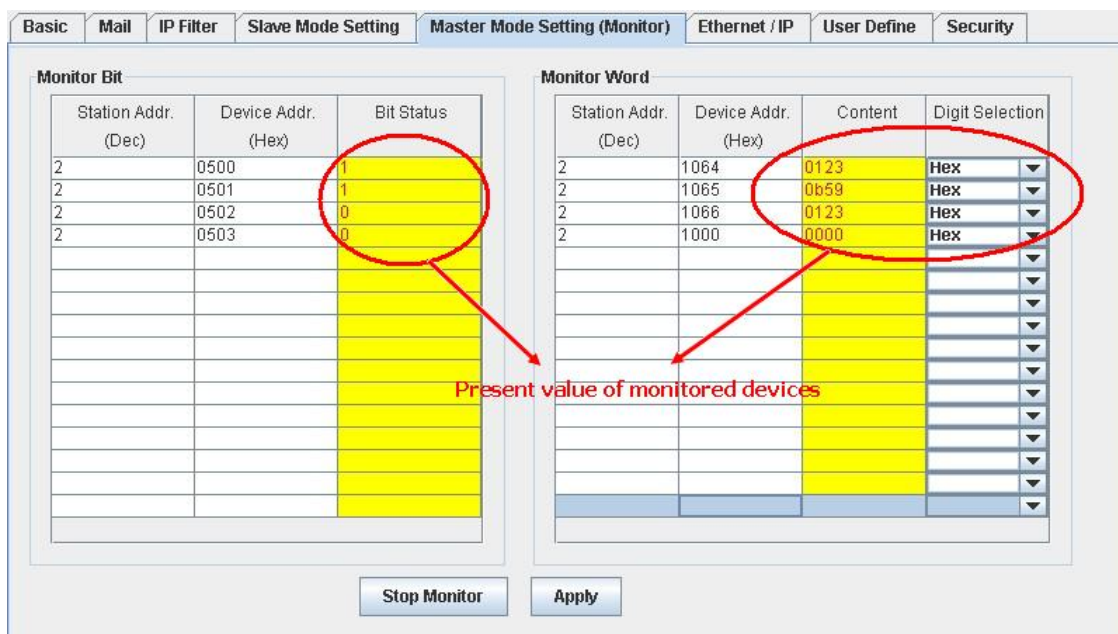

1. Monitor bit:
Device addresses for setting up the bit status of serial slave; able to read the content in the corresponding address of the designated slave.
2. Content:
The corresponding monitored value of the device address.
3. Digit Selection:
The monitored value can be displayed in hex or decimal form.
4. Monitor word:
Device addresses for setting up the word status of serial slave; able to read the content in the corresponding address of the designated slave.

Note:

Cache mode normally enabled, and Max. data in 16 slaves can be monitored. When the cache mode is enabled, the data you would like to read will be sent back directly from the register in IFD9507.

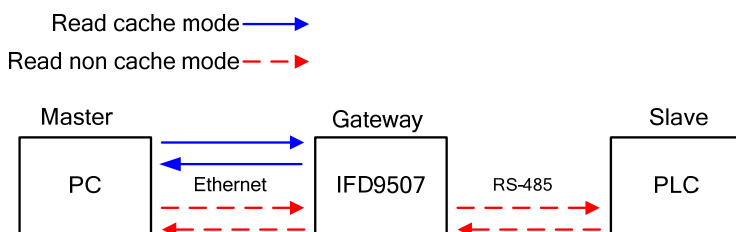

■ Setting up Slave Mode monitoring functions

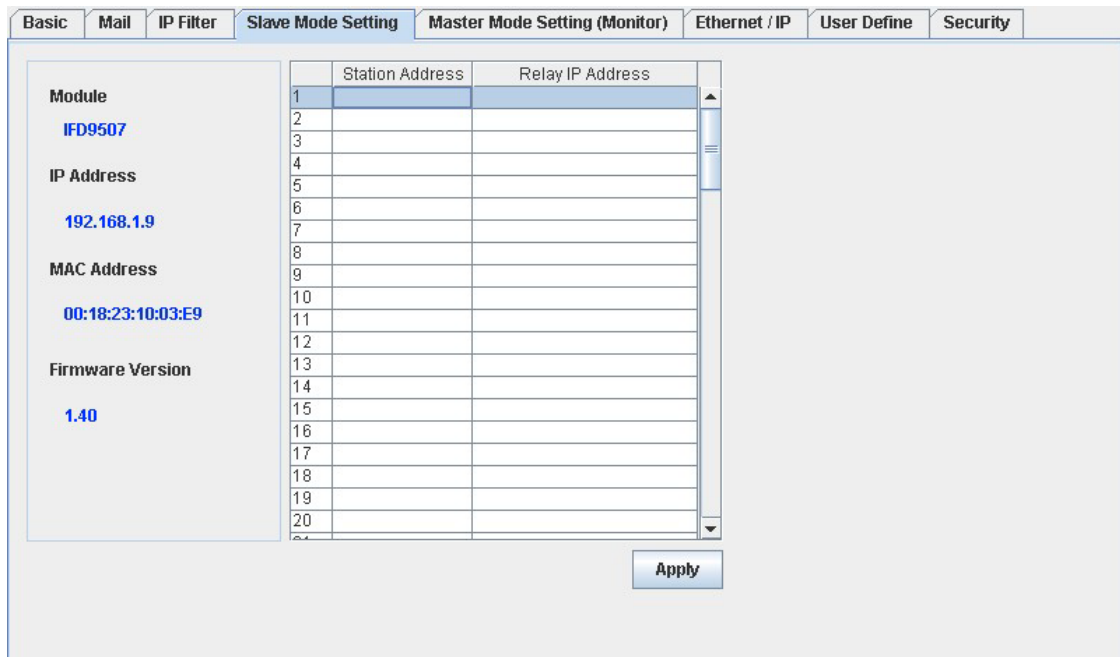

1. Serial slave mode: (used when in Modbus TCP protocol)

The instruction sent from the master is received and transferred to the network. Please designate the station address and relay IP address.

Station address: slave PLC address (Gateway and PLC address cannot be the same)

Relay IP address: serial master IP

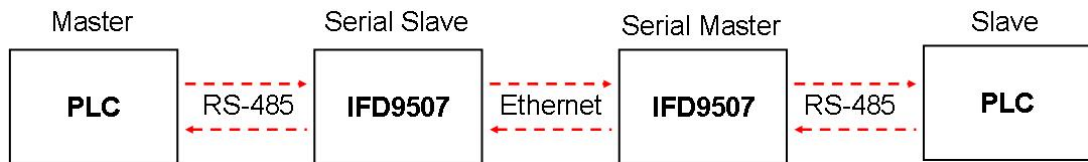

11.8 Ethernet/IP

You can read data in designated addresses in different equipment in the network by setting up IFD9507. The data can be temporarily stored in IFD9507 for fast storing and acquisition.

- Setting up Slave Mode connection parameters

The screenshot shows the 'Ethernet / IP' configuration window. The 'Type' is set to 'Communication Adaptor'. The 'Connection Parameters' section contains two tables. The first table lists four connection entries with columns for Dest IP, Timetick, Timeout Tick, Timeout (ms), Trigger, O --> T RPI, and T --> O RPI. The second table lists four instance entries with columns for In Instance, In Size, Out Instance, Output Size, Width, and Config Instance. An 'Apply' button is located at the bottom right.

	Dest IP	Timetick	Timeout Tick	Timeout (ms)	Trigger	O --> T RPI	T --> O RPI
1	192.168.1.72	64	40	2560	Cyclic	300000	100000
2	192.168.1.72	64	40	2560	Application Object	300000	100000
3	192.168.1.72	64	40	2560	Application Object	300000	100000
4	192.168.1.72	64	40	2560	Application Object	300000	100000

	In Instance	In Size	Out Instance	Output Size	Width	Config Instance
1	1	4	2	2	2 Bytes	6
2	1	4	2	2	2 Bytes	6
3	1	4	2	2	2 Bytes	6
4	1	4	2	2	2 Bytes	6

1. Dest IP
This is Destination IP address.
2. Timeout (ms)
Timetick * Timeout tick = Timeout
※ Available time tick: $2^0 \sim 2^{15}$
※ Max. Timeout tick: 255.
3. Trigger
There are three trigger types. The cyclic used to describe event that repeat in regular. Production occurs when a change of state is detected by application object. The Application object used to provide the run time exchange of messages across network.
4. O→T RPI
Originator to target requested packet interval.
When the trigger occurs, the packet is sent to the target within the set interval time.
5. T→O RPI
Target to originator requested packet interval.
When the trigger occurs, the packet is sent to the originator within the set interval time.
6. In Instance
Target input buffer Instance. Range: 1 ~ 65,535.
7. In Size
Target input buffer size. Range: 0 ~ 256.
8. Out Instance
Target output buffer instance. Range: 1 ~ 65,535.
9. Out Size
Target output buffer size. Range: 0 ~ 256.
10. Width
Data width
11. Config Instance
Configuration instance. Range: 1 ~ 65,535.

11.9 User Define

You can define your own format for data to be transmitted. The items to be defined include the fixed length, start item and stop item.

- Select RS-232 or RS-485 to connect the device.

- Switch to “User Define” page to set up the “Fix Length”, “Start Item” and “Stop Item”.

1. Listen Port/Destination Port:

Range: 1024 ~ 65535.

1. Fix Length:

When this is set, IFD9507 will transmit data following the fixed length.

2. Start Item:

The start item of data. Range: 1 ~ 3

3. Stop Item:

The stop item of data. Range: 1 ~ 3

When the start item and stop item are set, IFD9507 will transmit data following the start item and stop item. If the transmission time exceeds the Modbus time-out, IFD9507 will dispose of incomplete data.

Note:

When using two IFD9507 modules as Master and Slave and its user define functions, the settings of the fixed length, start item and stop item have to be consistent. If not, the data will be filtered automatically.

12 Application Examples – DCISoft

12.1 Setting up & Unlocking Password

Application	Setting up password by IFD9507 configuration
Steps	(1) Set up password in IFD9507. (2) Unlock IFD9507.

1. See 10.1 for the connection and how to set up the communication.
2. Open the setup page and switch to “Security” page.

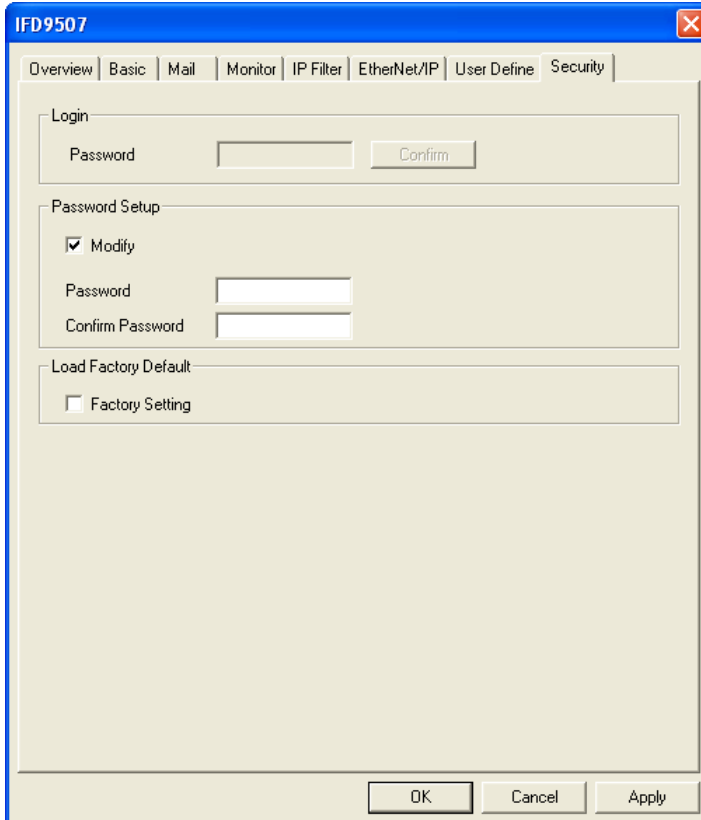

3. Check “Modify” and enter “aabb” in “Password” and “Confirm Password” columns. Click on “Apply” to save the password.

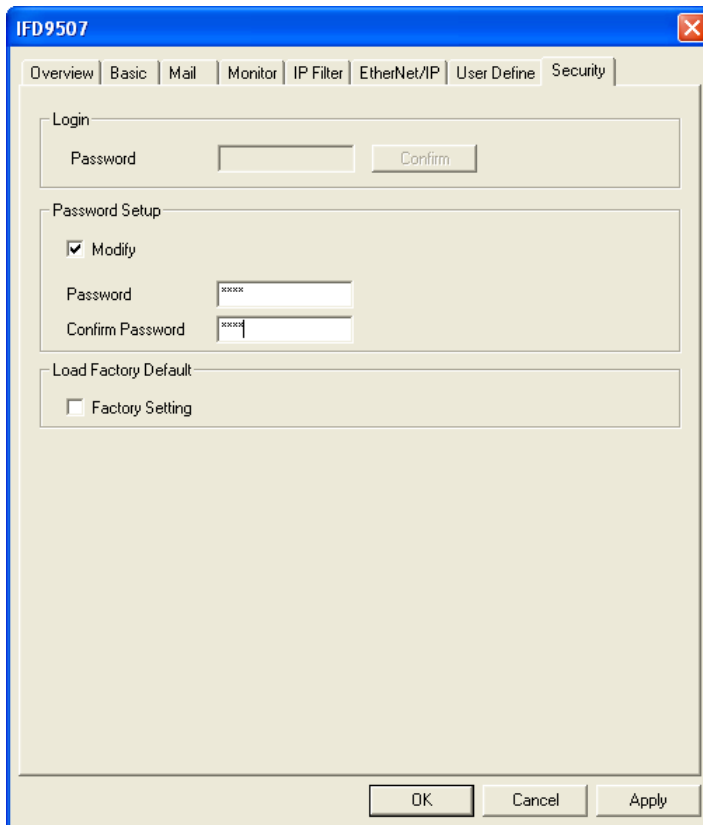

4. Open the setup page again, and IFD9507 is now locked by the password. You cannot open any of the settings now. Enter the password and press “Confirm”, and you will be able to unlock the editing function on other pages.

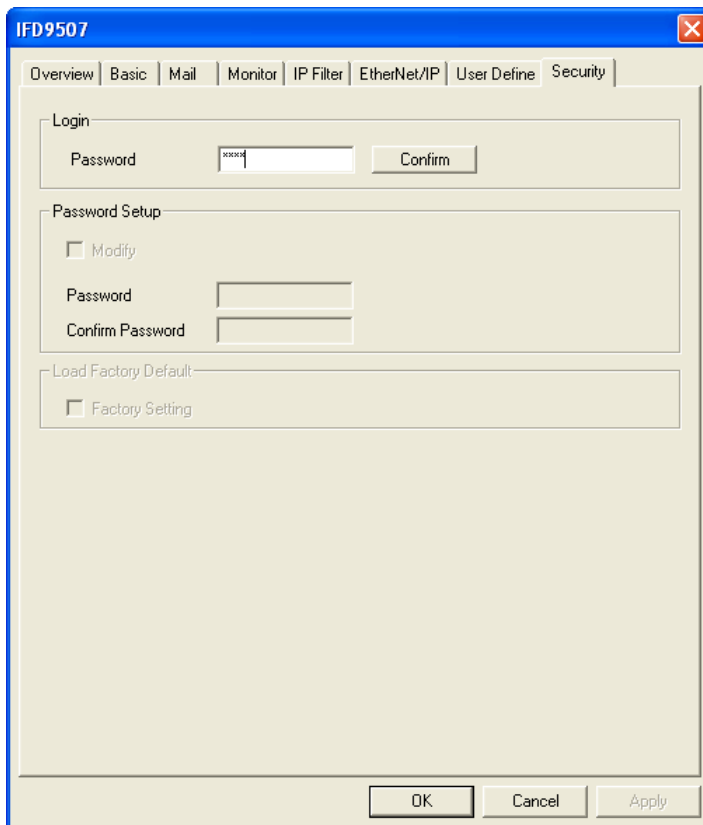

12.2 Password Loss (Returning to Default Settings by RS-232)

Application	Returning to default settings by RS-232.
Steps	(1) Set up password in IFD9507. (2) Supposed the password is forgotten, return to default settings through RS-232.

1. Use DVPACAB2A30 cable to connect the PC and IFD9507. Open the setup page.
2. Check "Factory Setting" box and the warning dialog box will appear. Click on "Yes" to return to default settings (in approx. 5 ~ 10 seconds), and the password will be cleared as well.

12.3 IP Filter Protection

Application	Setting up IP filter protection. Only connections to 192.168.0.7 and 172.16.0.1 ~ 172.16.0.255 are allowed.
Steps	(1) Check "Enable IP Filter" box. (2) Set up IP address to "192.168.0.7" and netmask to "255.255.255.255". (3) Set up the IP address to "172.16.0.1" and Netmask to "255.255.255.0".

1. See 10.1 for the connection and how to set up the communication.
2. Open the setup page and switch to "IP Filter" page.

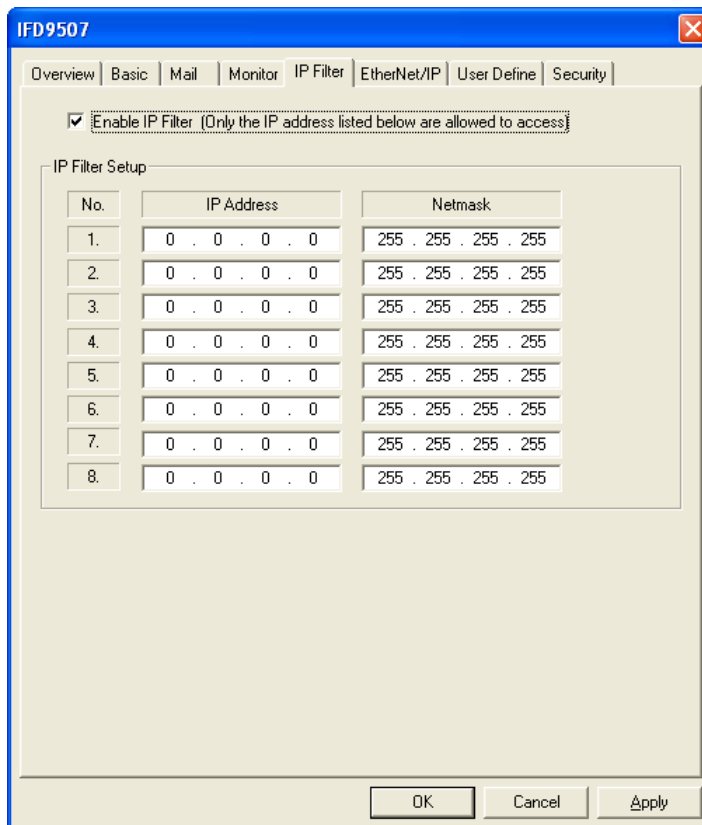

3. Check "Enable IP Filter" box. Enter "192.168.0.7" into No. 1 IP and "255.255.255.255" in all "Netmask" columns.

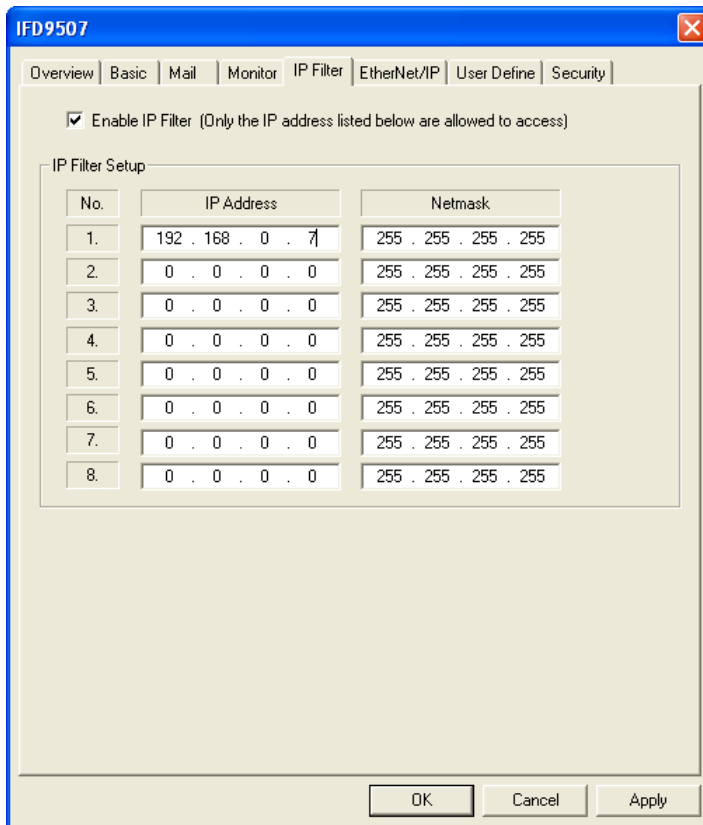

4. Enter "172.16.0.1" in No. 2 IP and "255.255.255.0" in No. 2 Netmask column. Click on "OK" to complete the setting. Only the equipment within the UP range can be connected.

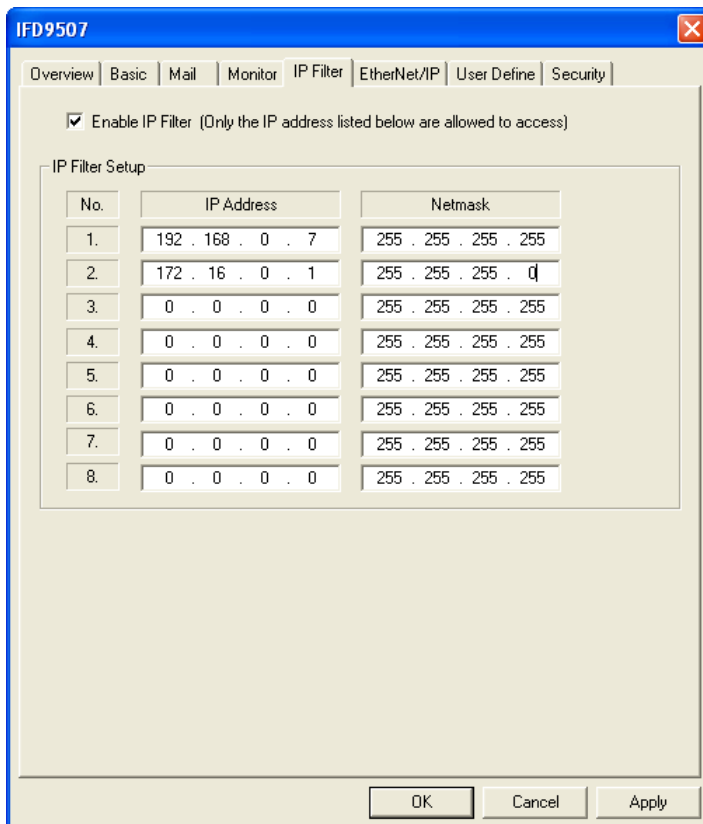

12.4 Application of E-Mail

Application	Sending E-Mail to notify the administrator when Alarm 1 is triggered.
Steps	(1) Check "Alarm 1" to enable it. (2) Set the IP of SMTP server to " 192.168.1.99" and "Mail From" to "Message@Delta" (3) Set the E-mail Subject of Event to "MAIL ALARM". (4) Set the E-mail address of administrator to test@Delta.com.tw

1. See 10.1 for the connection and how to set up the communication.
2. Open the setup page and switch to "Mail" page.

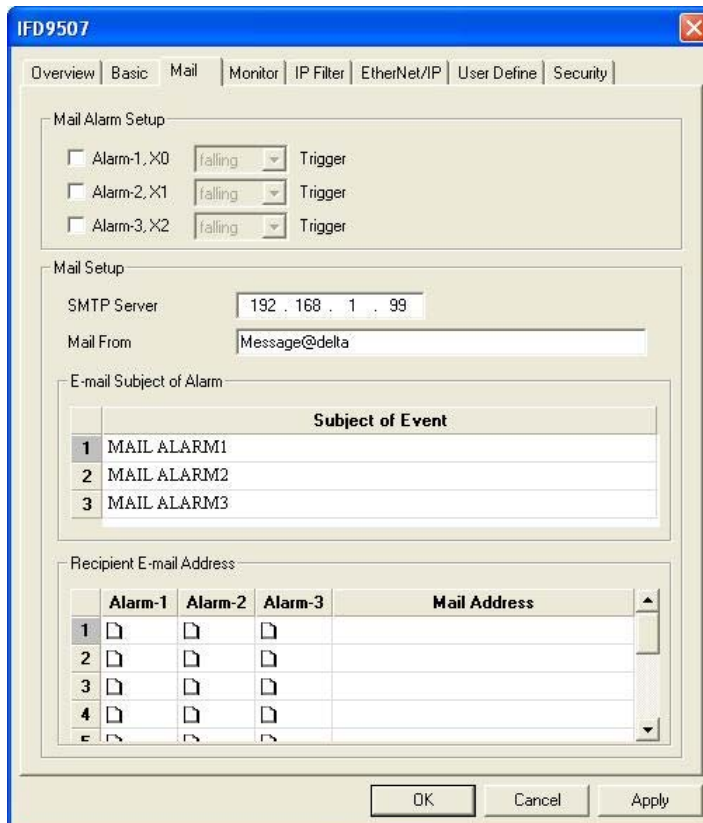

3. Setting up "Mail" page and check "Mail Alarm Setup".
 Enter SMTP server address, "Mail From" column, "Subject of Event" and "Recipient E-mail Address". For example, when Alarm 1 is triggered, the mail will be sent to test@sample.com. Trigger Alarm 1 by "low". Enter 172.16.144.121 into "SMTP Server" column and Mail From Message@ENA01. Enter "MAIL EVENT" as the subject and recipient e-mail address as test@delta.com.tw. Check "Alarm 1" and press "OK" to complete the settings.

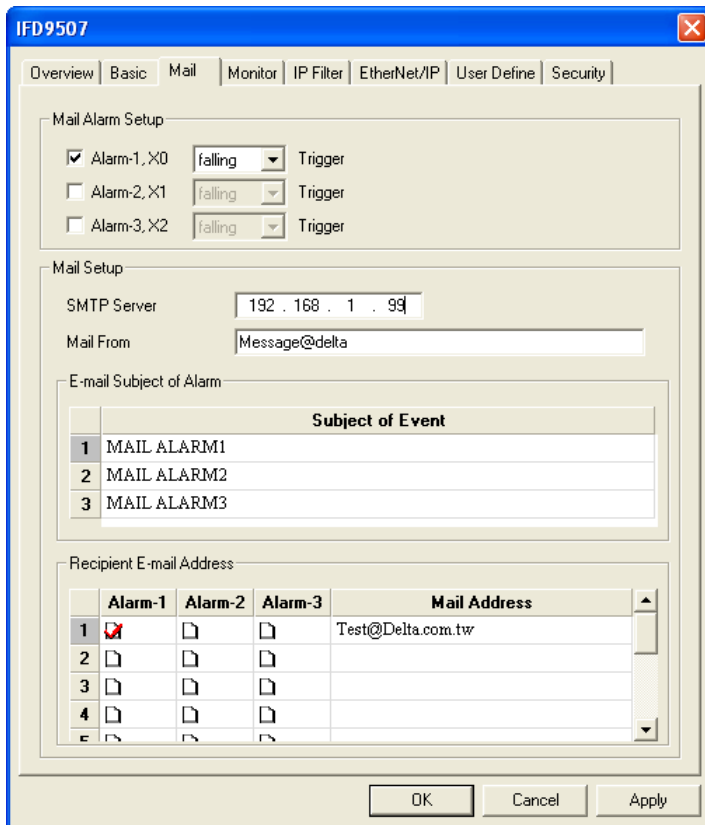

12.5 Monitoring Mode

Application	Writing the address of the device to be monitored into the monitor table.
Steps	<ol style="list-style-type: none"> (1) Use monitor bit and monitor word functions. (2) Monitor bit data in station address 1, H100 and H300, and word data in station address 1 H150. (3) Monitor bit data in station address 2, H200. (4) Monitor word data in station address 3, H200. (5) Monitor word data in station address 4, H100. (6) Monitor bit quantity: 3; monitor word quantity: 3

1. See 10.1 for how to set up communication.
2. Open IFD9507 Configuration page and switch to “Monitor” page.

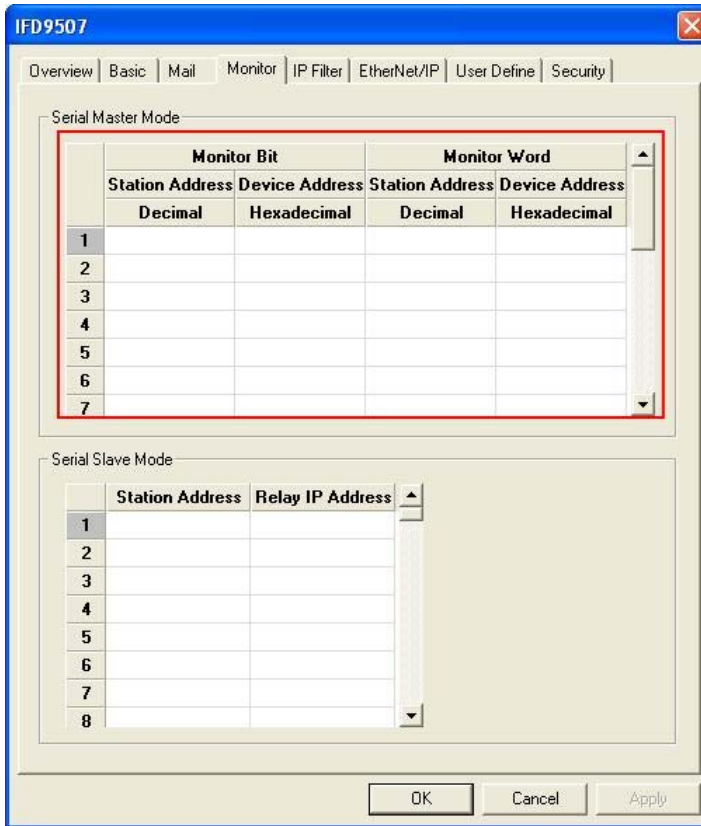

3. The settings:

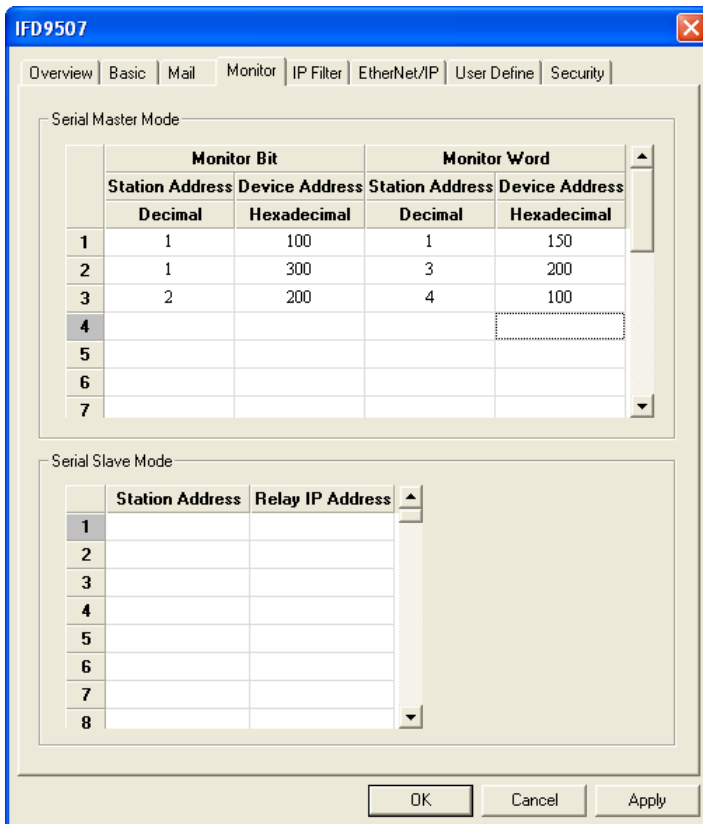

Note:

When the cache mode is enabled, you do not need to modify the station address and device address. You will read data from IFD9507, in which way you will be able to speed up the reading.

12.6 Application of Virtual COM Port

Application	Through the virtual COM port, IFD9507 is able to transmit the data sent to RS-232 to the Ethernet by connecting to the software supporting serial ports, e.g. Delta's WPLSoft, VFDSOft and ASDA-Soft. See the example below for how to connect IFD9507 to VFD-E AC motor drive through the virtual COM port by VFDSOft.
Steps	<ol style="list-style-type: none"> (1) Select "User Define" protocol and set the parameters in the serial master and serial slave to the ones consistent with those in VFD-E. (2) Set up virtual COM port. (3) Open Delta VFDSOft, set up the communication format (COM Setup) and establish the connection.

1. Setting up Virtual COM Port

- For the COM setting, select "User Define" and set the communication parameters to the ones consistent with those in VFD-E.

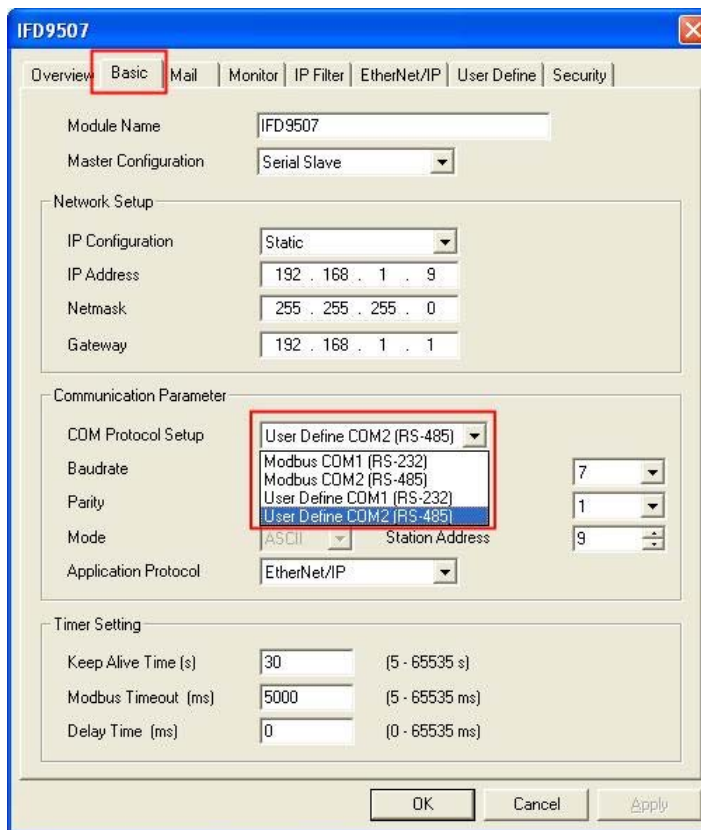

- Switch to "User Define" page and select "Listen Port".

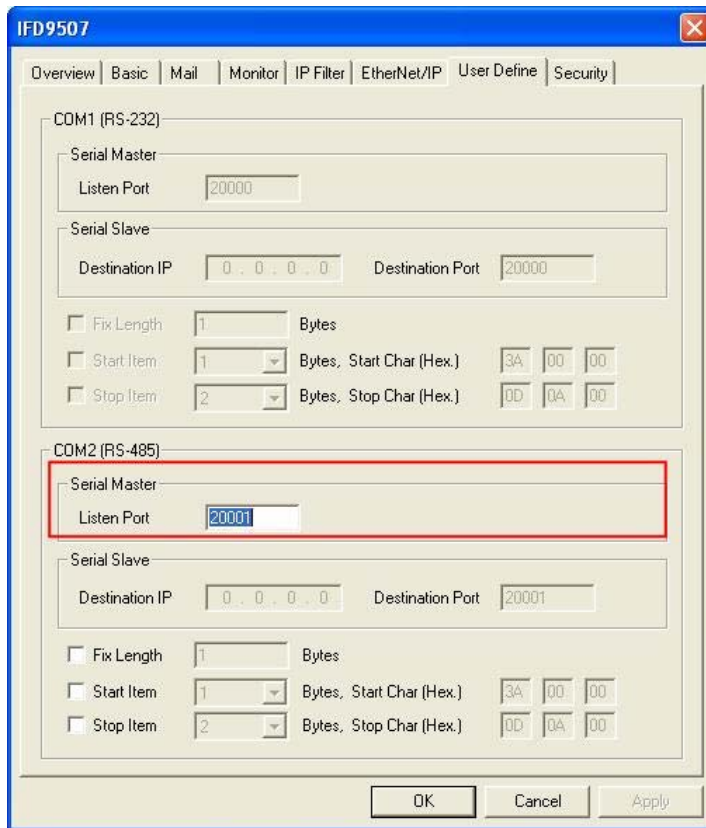

- Open Virtual COM setup page.

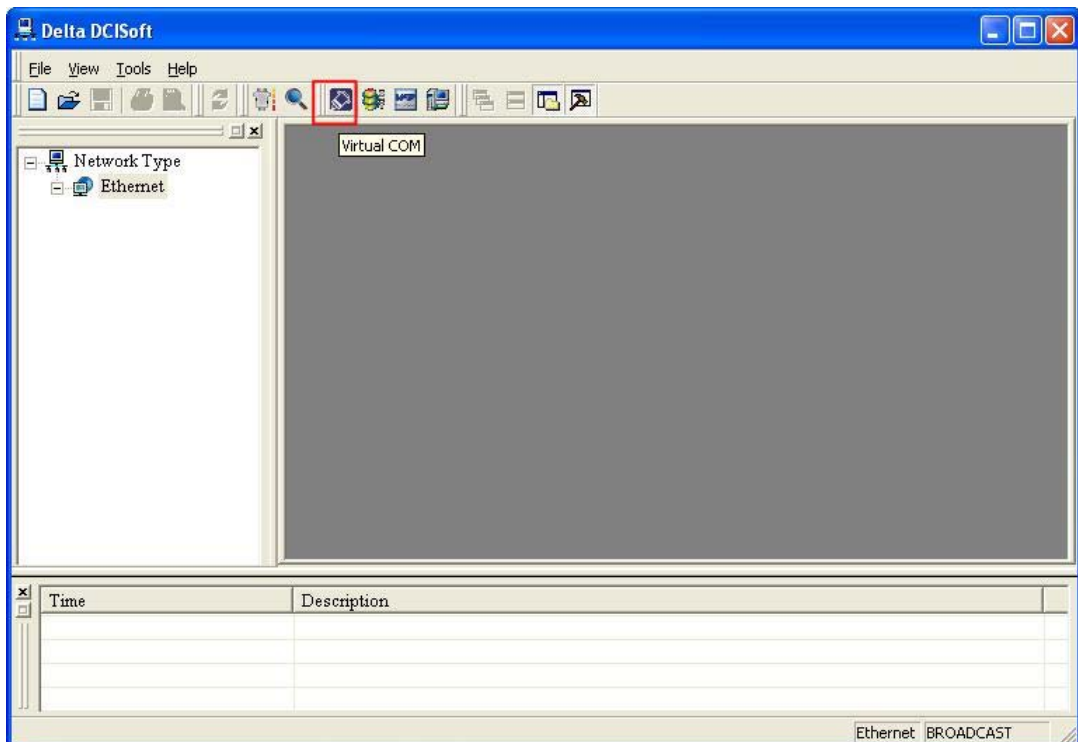

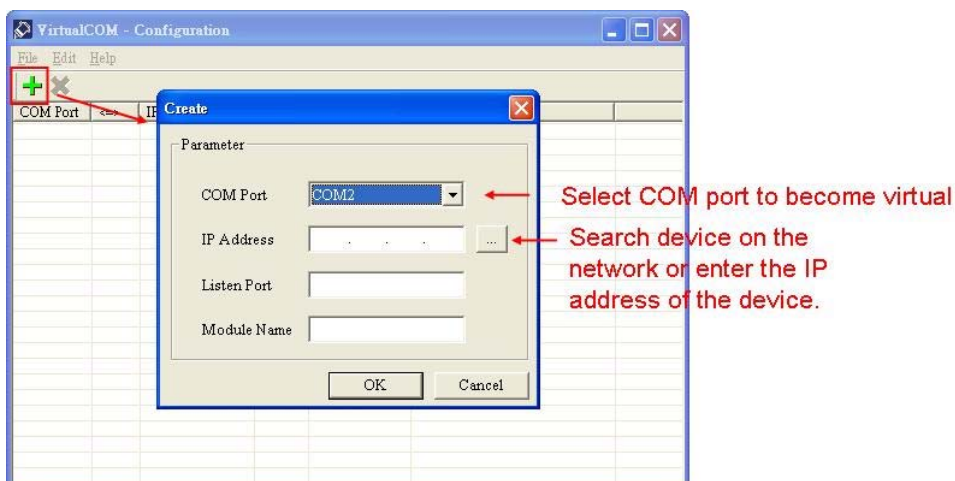

- Press “OK”, and you will see all the devices connected on the network.

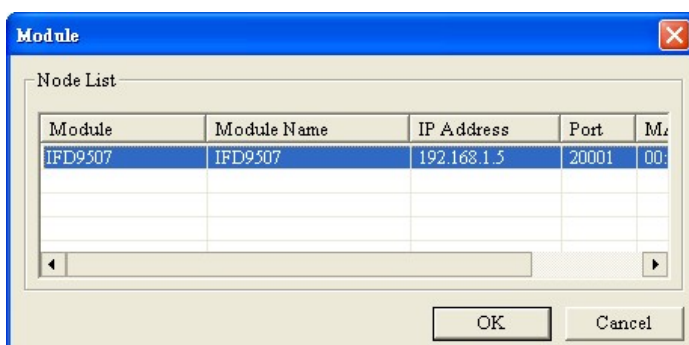

- Select the module you need and press “OK”. Relevant information of the device will be imported automatically. Press “OK” to complete the setup.

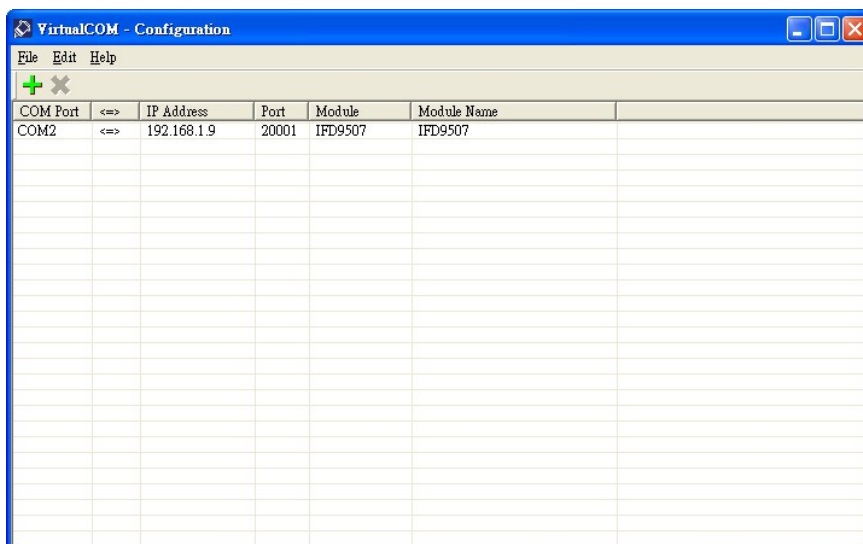
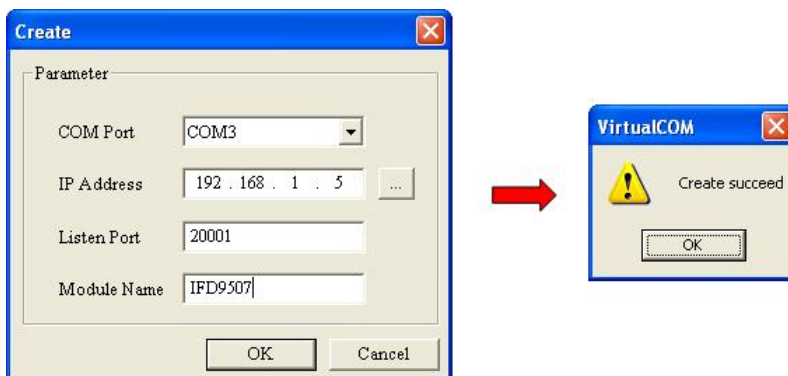

- Once the setup is successful, you can see the virtual COM you set in the Device Manger.

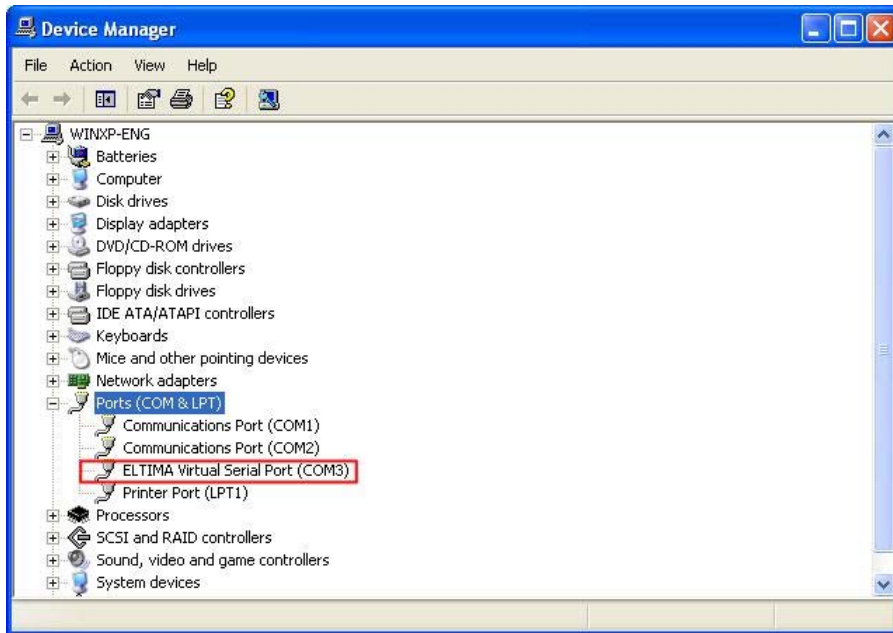

2. Using Virtual COM in Delta VFDSOft

- Open Delta VFDSOft.

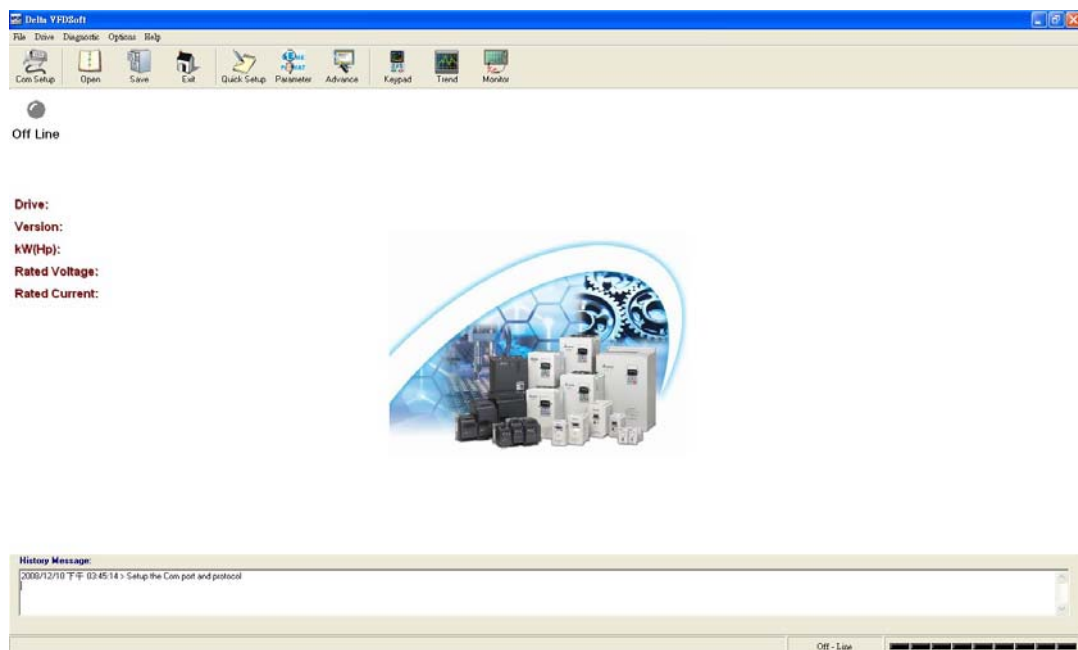

- Setting up communication format (COM Setup)
Enter the virtual COM (COM2) set in the previous steps to "Com Port" column. Next, enter the communication format of VFD-E (38400, 7, E, 1) and press "Test" button. Once the "Success" light is ON, the communication test is regarded successful.

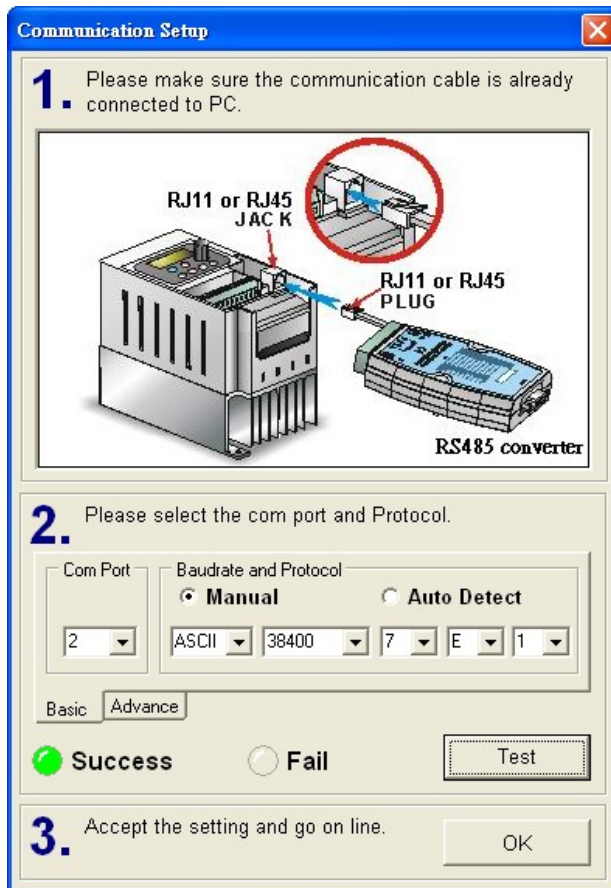

- Press "OK", and IFD9507 will be able to communicate with VFD-E by VFDSOft.

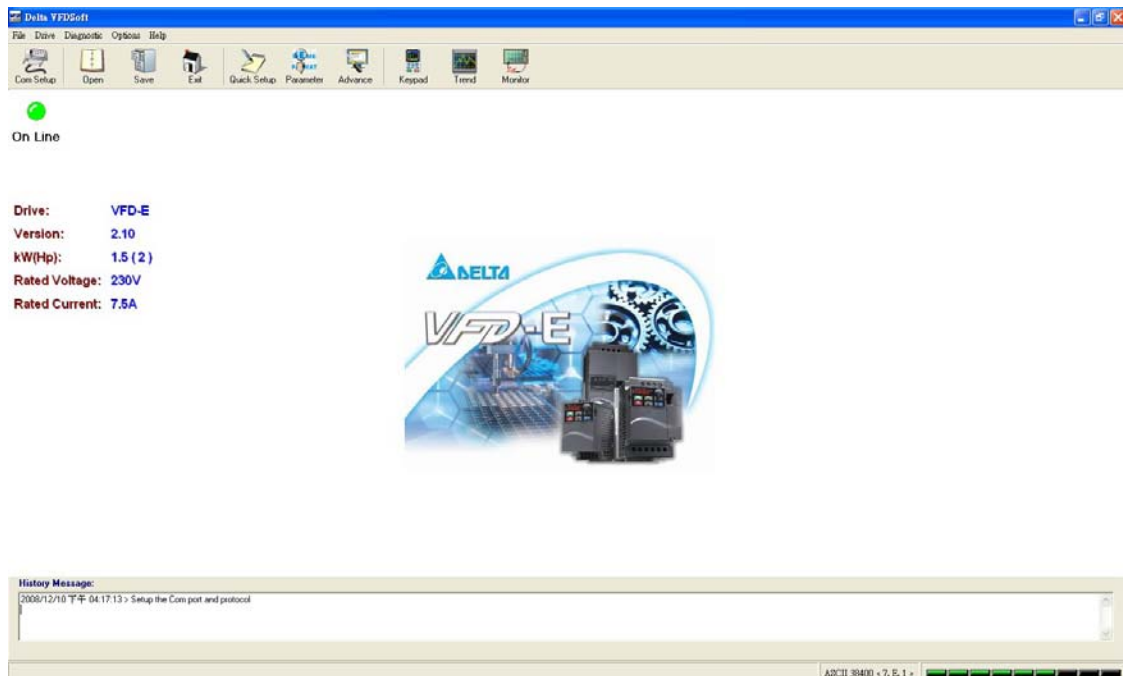

13 Application Examples – AB Software (Revision:2.10.118.0)

13.1 Serial Slave

Using Delta PLC DVP28SV11T to control AB PowerFlex 40P via IFD9507.

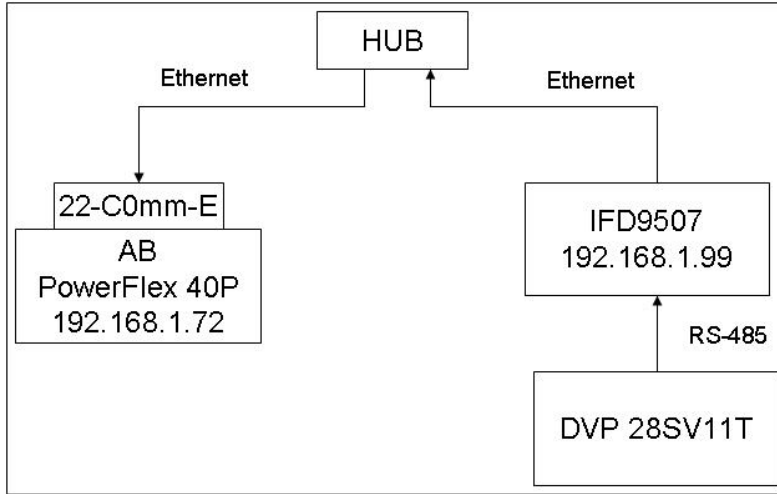

- Configure 22-COMM-E IP
 - Use AB software “Driver Explorer Application” to Set the PowerFlex40P+22CommE IP.
 - 1. Open Driver Explorer Application.
 - 2. Select “Configure Communication” in Explore.

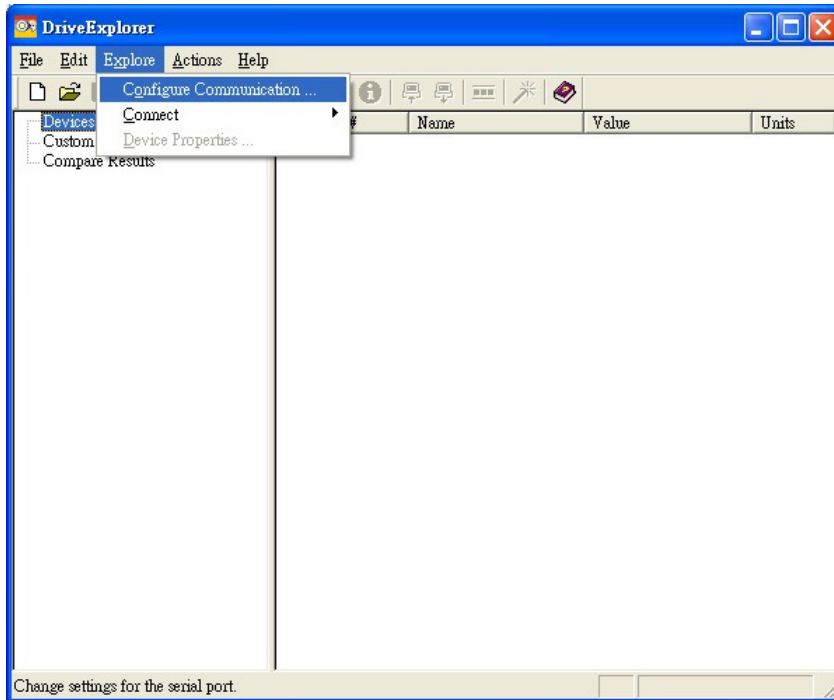

- 3. Select “Serial”
 - Select your RS232 com port, Baud = “38400”, Checksum Type=“CRC-16” and click “OK”

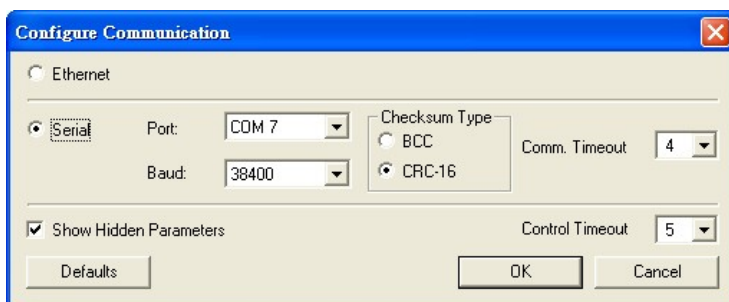

4. Select "Connect Serial Point-to-Point" in Explore.

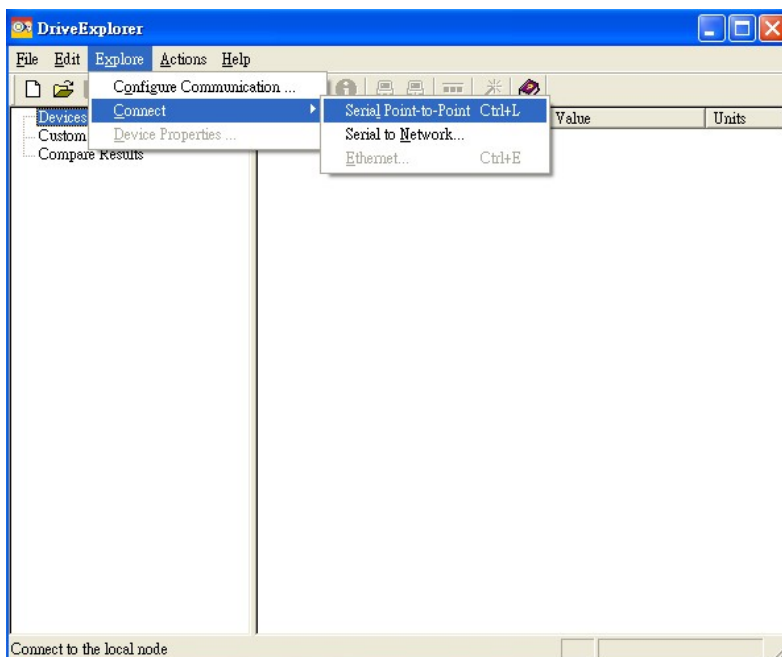

5. Select "Parameter List" in 22-COMM-E Ethernet/IP and enter "IP" in IP Addr Cfg1~Cfg4 and "Netmask" in Subnet Cfg1~Cfg4.

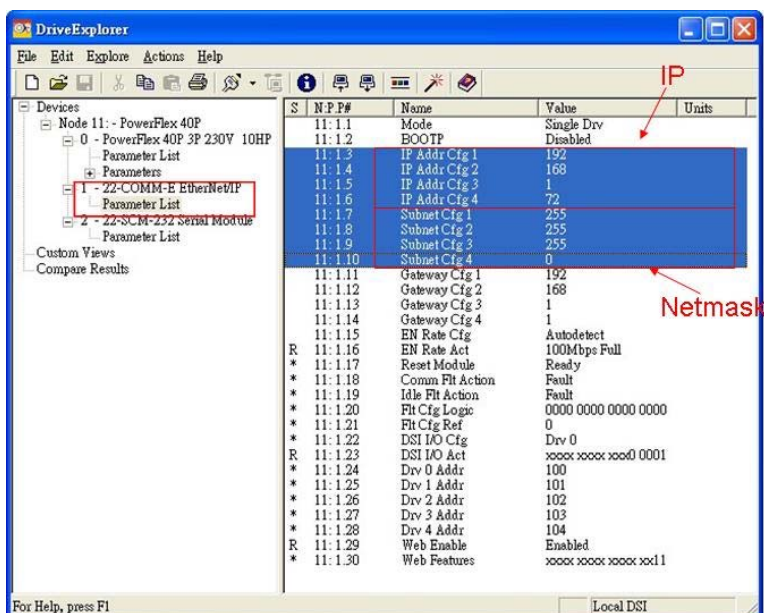

■ DCISoft configuration

1. Open DCISoft "Basic" configuration screen.
2. Select "Serial Slave" in Master Configuration.

3. Select "Static" in IP Configuration.
4. Enter "192.168.1.99" in IP Address field.
5. Enter "255.255.255.0" in Netmask field.
6. Select "Ethernet/IP" in Application Protocol.
7. Enter "231" in Station Address.
8. Press "OK".

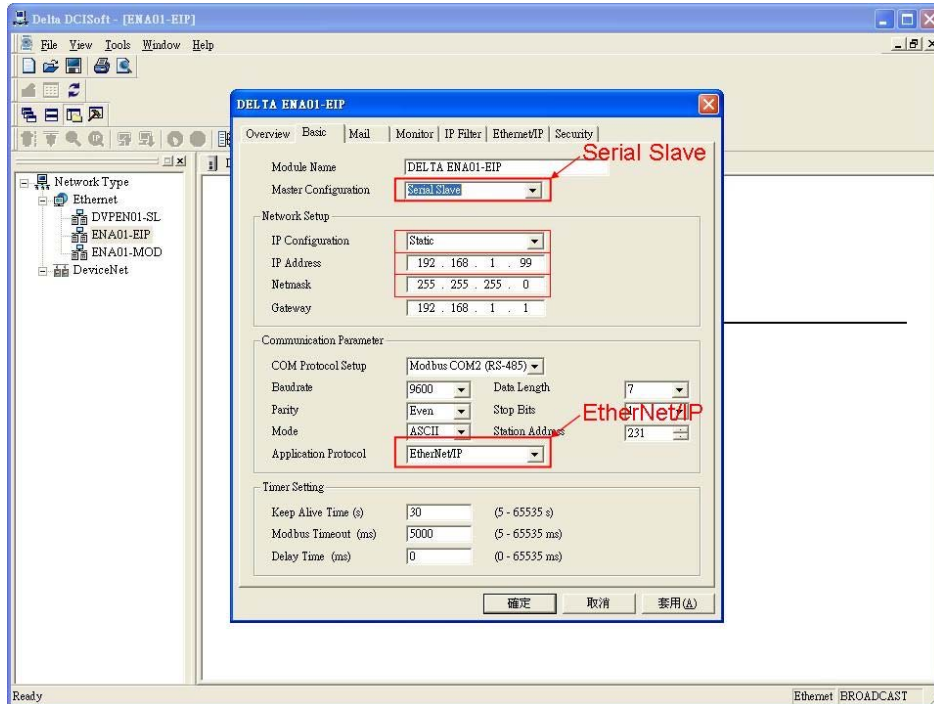

9. Open DCISoft "Ethernet/IP" configuration screen.
10. Enter AB PowerFlex 40P IP Address "192.168.1.72" in Dest IP Field.
11. Select "Cyclic" in Trigger.
12. Enter PowerFlex 40P parameter "1", "4", "2", "2", "2 byte", "6" in In Instance, In Size, Out Instance, Out Size, Width, Config Instance in turn.
13. Press "OK".

■ WPL program

1. Write control data to DVP IFD9507 IN register (H0500)
2. Use WPL MODWR instruction to write the control data to EIP (H0500).
3. Ex. RUN : 11100000011010→H701A

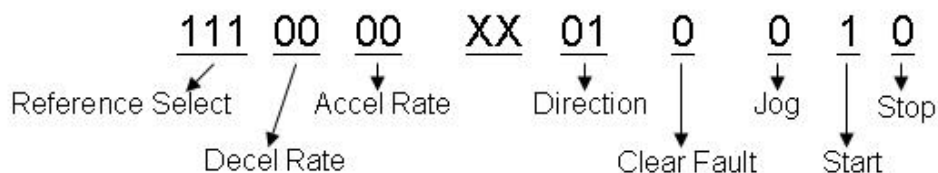

STOP : 11100000011001→H7019

Reverse RUN : 111000000101010→H702A

4. Select which communication index you want. Write 1~4 to DVPIFD9507 BR15 (H000F). Use WPL MODWR instruction to select the DVP IFD9507 BR (H0500) index.
5. Set the I/O Enable Flag (BR14).

Use WPL MODWR instruction to write "0101" set I/O enable Flag.

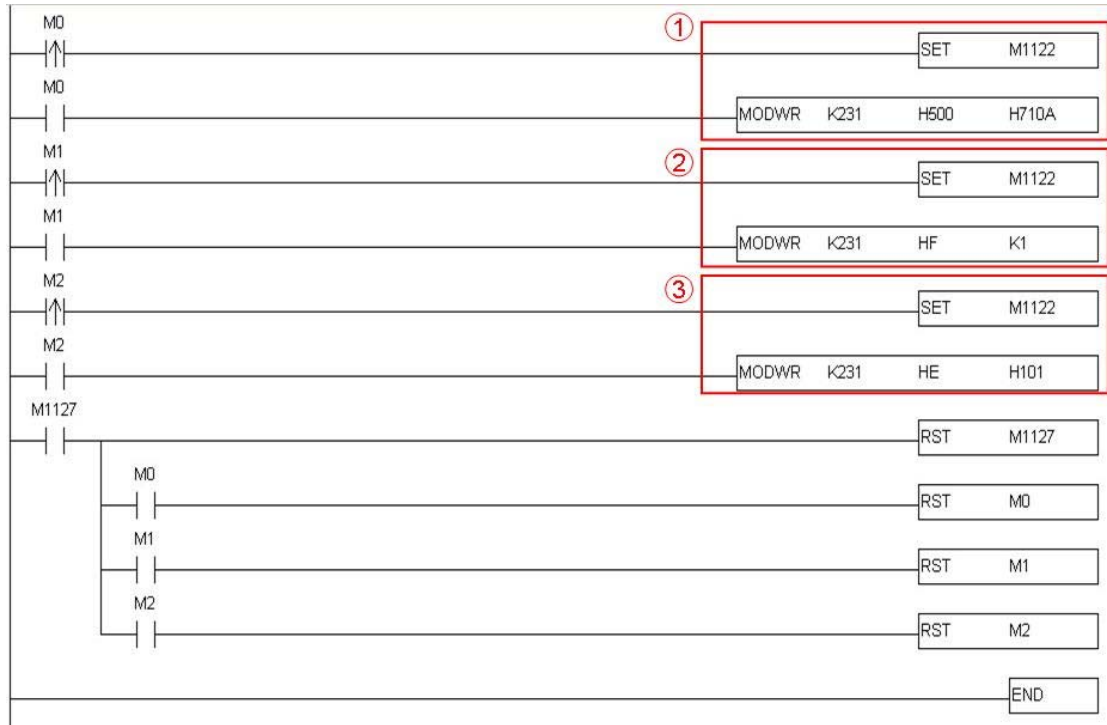

13.2 Serial Master

Using AB PLC 1769-L32E to write Delta PLC DVP28SV11T bit and register via IFD9507.

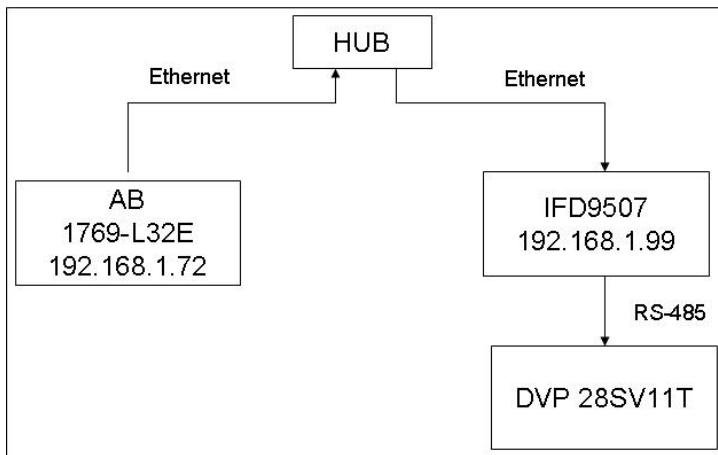

■ Configure RSLinx 1769-L32E

1. Open RSLinx and configure drivers

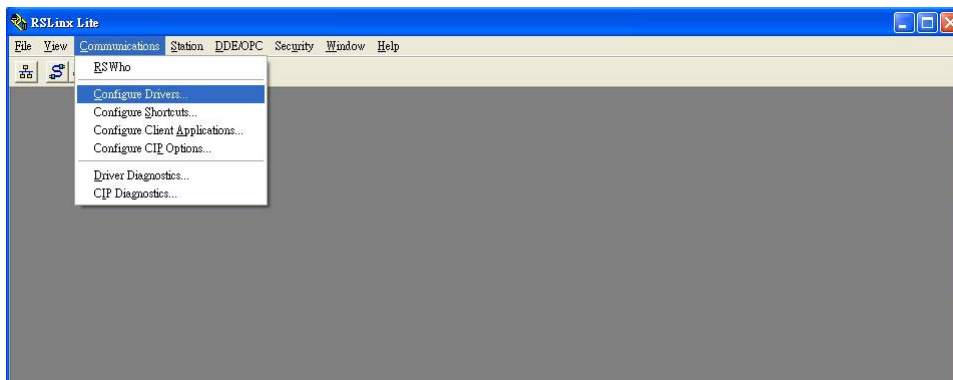

2. Select RS232 device and click "Add New"

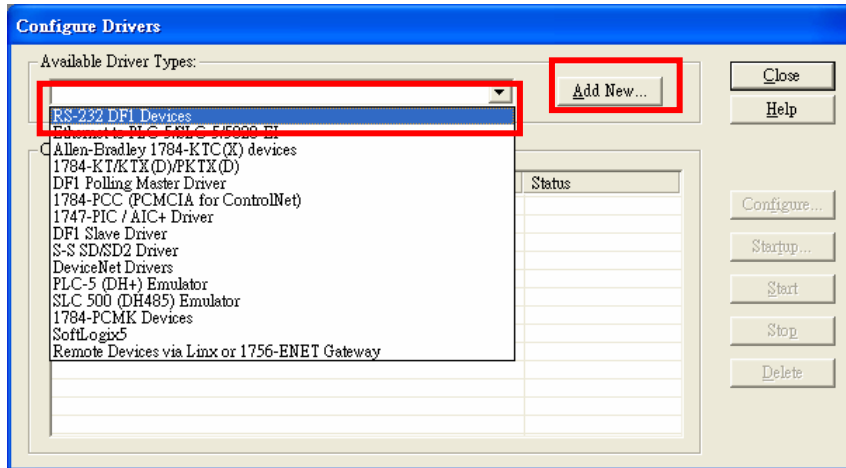

3. Select Com port and click “Auto-Configure”. When it is successful, it will show successful messages.

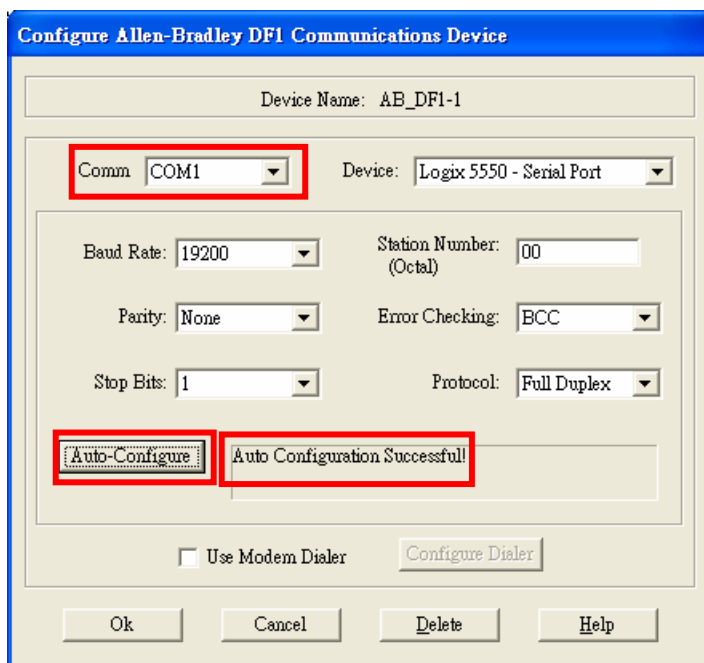

- Configure IFD9507
 1. Open DCISoft “Basic” configuration screen.
 2. Select “Serial Master” in Master Configuration.
 3. Select “Static” in IP Configuration.
 4. Enter “192.168.1.99” in IP Address field.
 5. Enter “255.255.255.0” in Netmask field.
 6. Enter “231” in Station Address
 7. Press “OK”.

The screenshot shows the IFD9507 configuration window with the following settings:

- Module Name: IFD9507
- Master Configuration: Serial Slave
- Network Setup:
 - IP Configuration: Static
 - IP Address: 192 . 168 . 1 . 99
 - Netmask: 255 . 255 . 255 . 0
 - Gateway: 192 . 168 . 1 . 1
- Communication Parameter:
 - CDM Protocol Setup: User Define CDM2 (RS-485)
 - Baudrate: 9600
 - Data Length: 7
 - Parity: Even
 - Stop Bits: 1
 - Mode: ASCII
 - Station Address: 9
 - Application Protocol: Modbus/TCP
- Timer Setting:
 - Keep Alive Time (s): 30 (5 - 65535 s)
 - Modbus Timeout (ms): 5000 (5 - 65535 ms)
 - Delay Time (ms): 0 (0 - 65535 ms)

Buttons: OK, Cancel, Apply

■ Configure RSLogix 5000

1. Select "New".
2. Select controller type "1769-L32E" and type Name → click "OK".

The screenshot shows the "New Controller" dialog box with the following settings:

- Vendor: Allen-Bradley
- Type: 1769-L32E CompactLogix5332E Controller
- Revision: 16
- Redundancy Enabled
- Name: Program
- Description: (empty text area)
- Chassis Type: <none>
- Slot: 0 Safety Partner Slot
- Create In: C:\RSLogix 5000\Projects

Buttons: OK, Cancel, Help, Browse...

3. Add new Ethernet module.

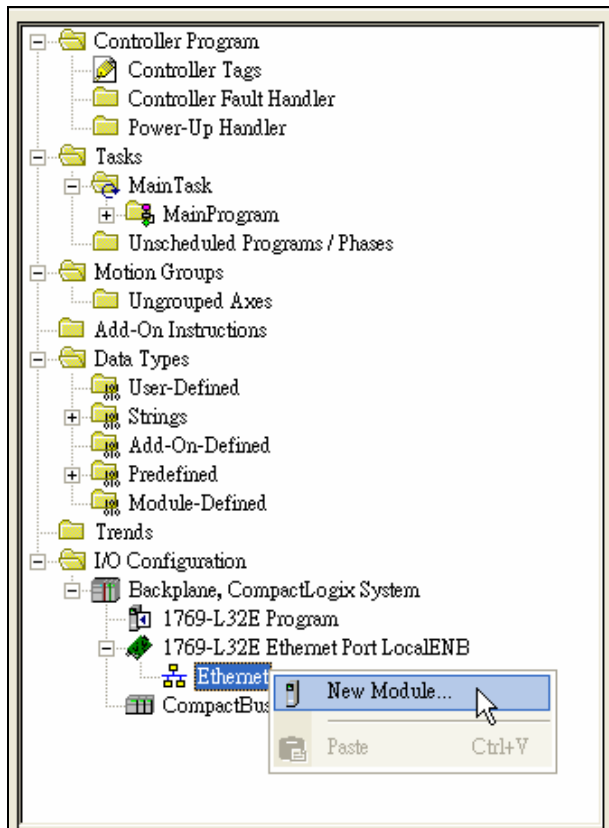

4. Select “communications” module.

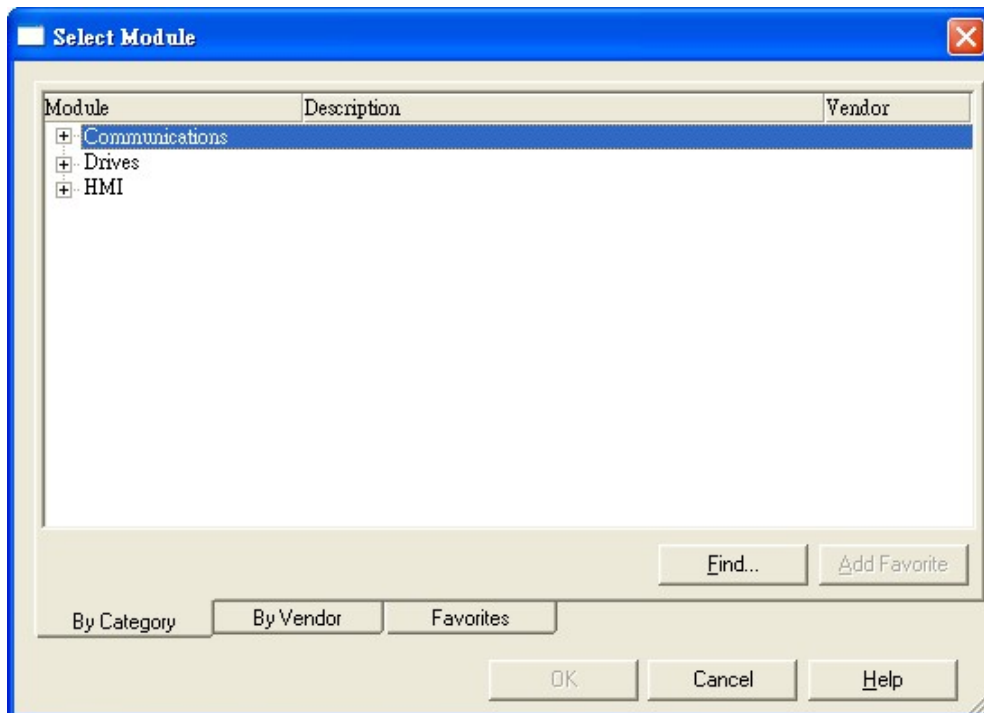

5. Select “ETHERNET-MODULE” and click “OK”.

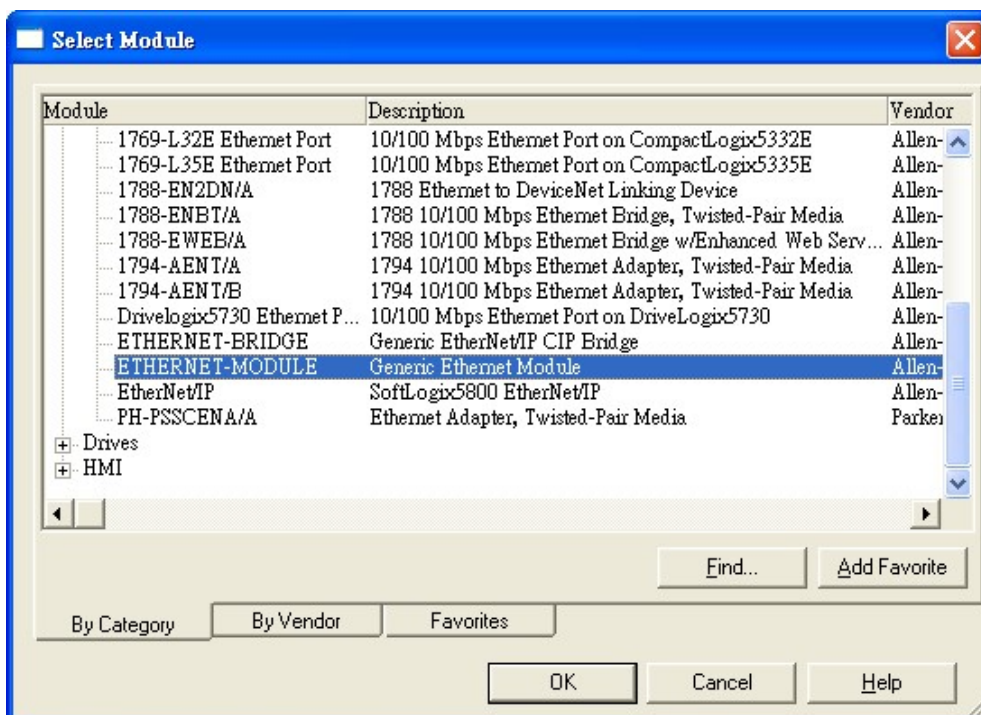

- Enter module name. Select Comm Format "Data-INT". Enter instance "101", Size "100", Out Instance "100", Output Size "100", Configuration Instance "6" and, Configuration Size "0" and IP: "192.168.1.99".

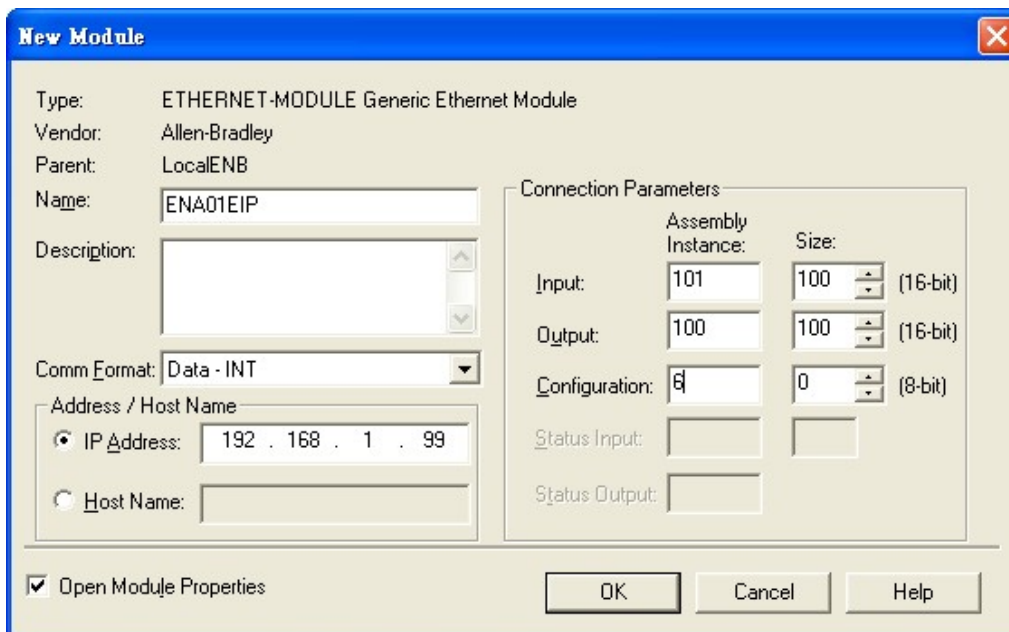

- Enter Requested Packet Interval "500.0 ms" and click "OK"

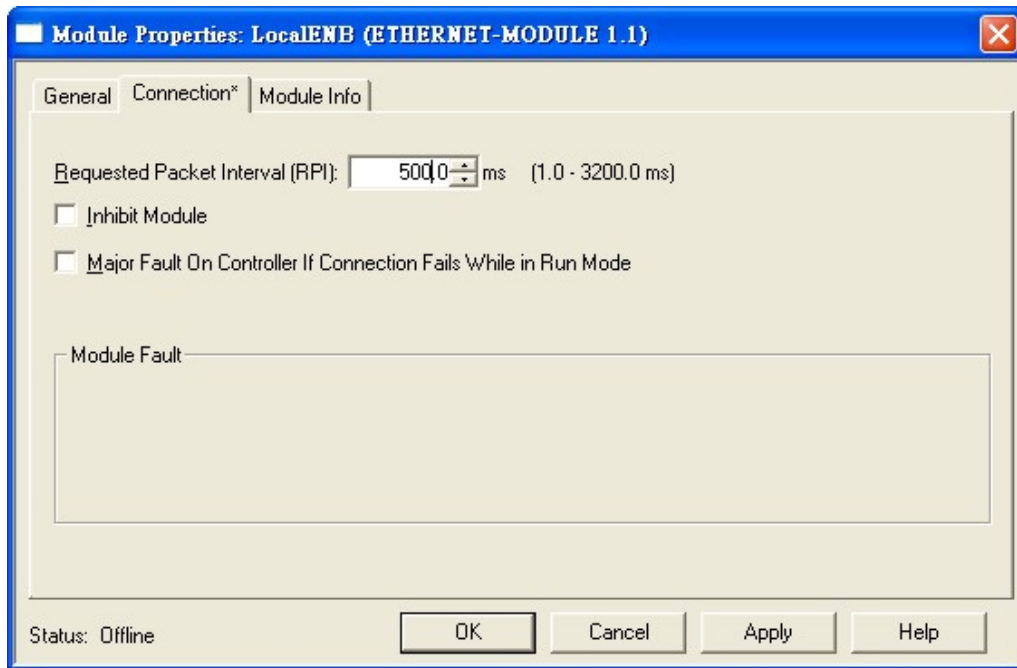

8. Open MainRoutine screen

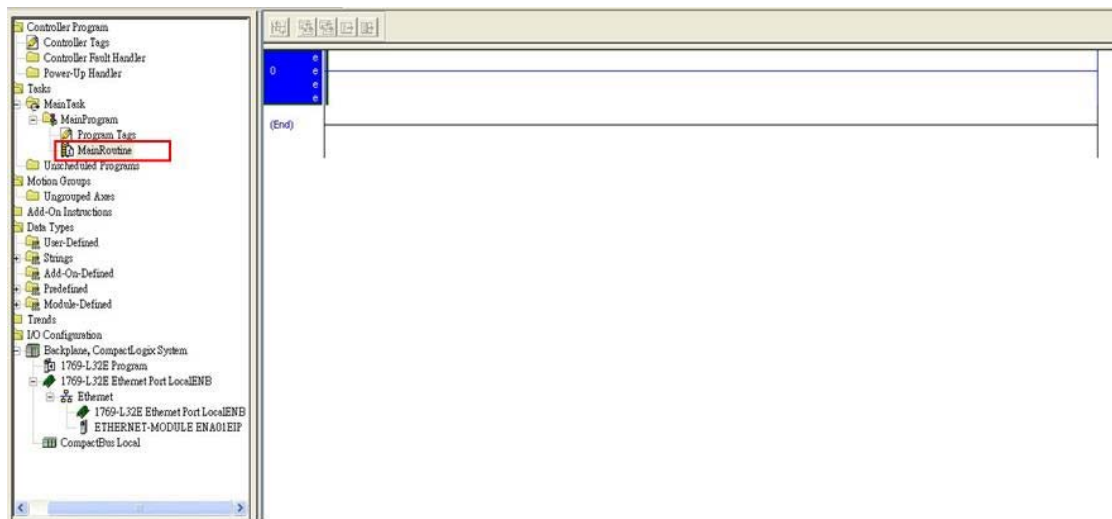

9. Create New Tag “SW1” (Use SW1 to control instruction ON/OFF)

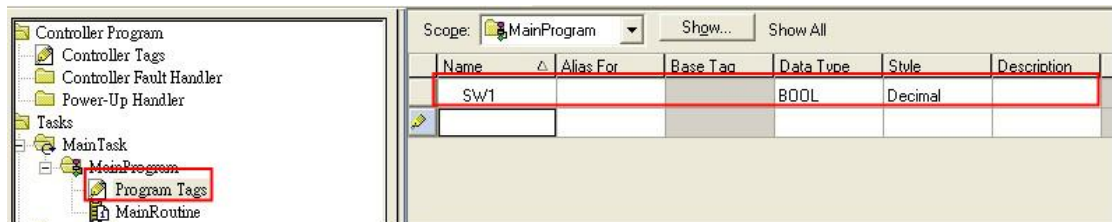

10. Using Move instruction move data to “ENA01EIP: O.Data” register.

Ex : Set Delta PLC Y0 (H0500) ON

Send instruction MODBUS TCP : 06 01 05 05 00 FF 00

- (1) H0006: Mov “06” to ENA01EIP: O.Data[0]
- (2) H0105: Mov “261” to ENA01EIP: O.Data[1]
- (3) H0500: Mov “1280” to ENA01EIP: O.Data[2]
- (4) HFF00: Mov “65280” to ENA01EIP: O.Data[3]

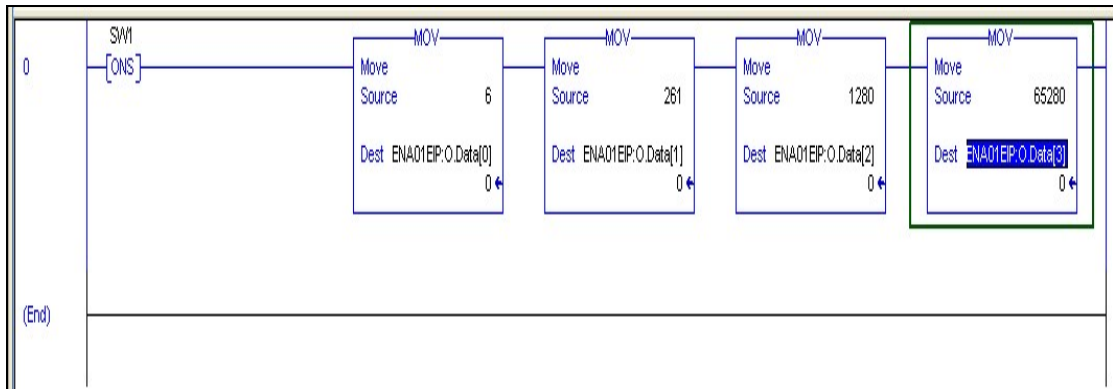
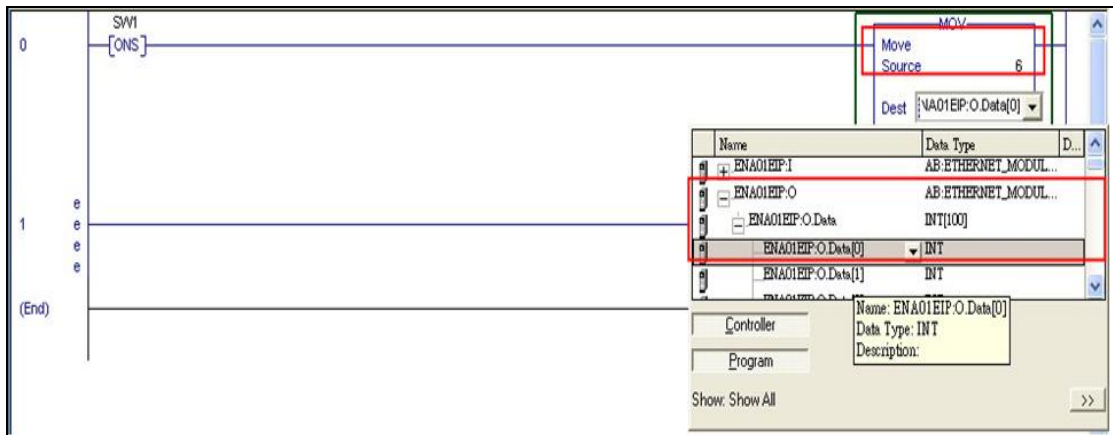

11. Download this program and make the PLC 1769-L32E go online.
12. Toggle Bit "SW1".