



Automation for a Changing World

Delta Temperature Controller DT Series



www.deltaww.com



DELTA
Smarter. Greener. Together.

Features

Many Sizes Available:

- From 48x24mm to 96x96mm, all panel sizes comply with international standards

Quality Assurance:

- All temperature controllers adopt an isolated switching power supply
- 100 ~ 240VAC input power supply applicable in all countries of the world
- CE, UL and C-Tick certified



Supports Various Sensors:

- Various built-in sensor input modes: Thermocouple, platinum RTD or linear voltage/current

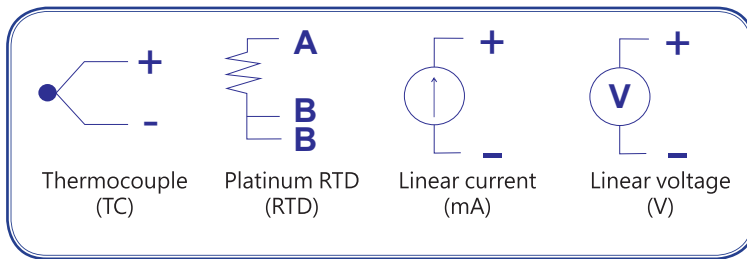

Various Output Modes:

- Relay, voltage pulse, linear voltage, and linear current

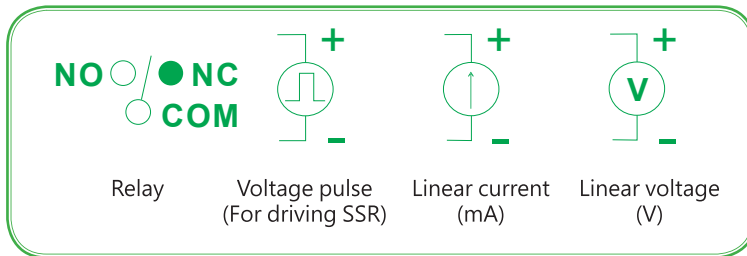

Stable Control:

- Built-in PID control function, with accurate auto-tuning (AT).
- PID parameters are automatically calculated, enhancing the stability of the system and accuracy of control

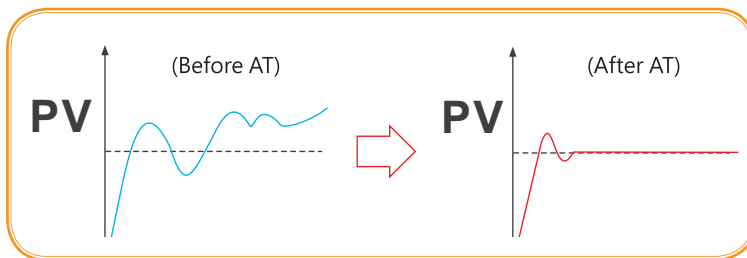

Current Transformer (CT):

- CT can enable the off-line alarm and can detect if the current is overloaded





Programmable Control:

- Max. 8 patterns available, with 8 steps in each pattern.
No master controller is required for planning many kinds of temperature control curves

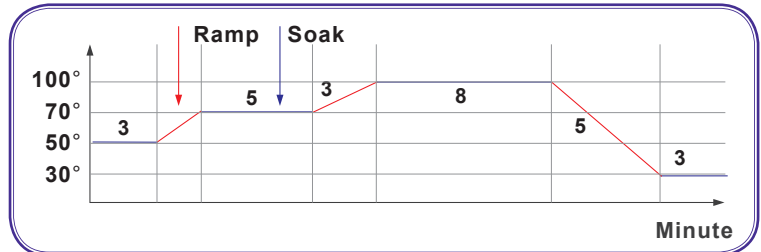

Communication:

- RS-485 communication interface, supporting Modbus ASCII/RTU communication

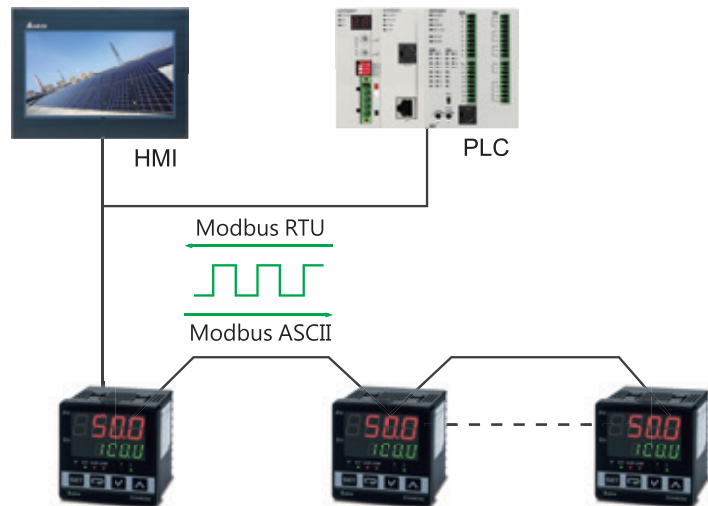

Safety:

- The key-locking function and communication protection prevents malfunction



Dual Output Control:

- Able to execute heating and cooling controls at the same time, allowing the system to reach the set temperature quickly

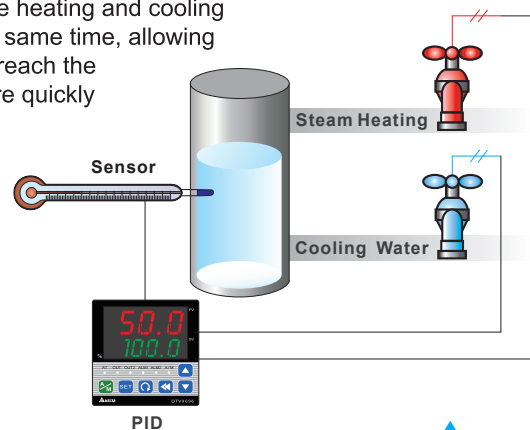

Products

DT3 High Speed Intelligent Temperature Controller

The Delta temperature controller DT3 series is designed with upgraded hardware and higher specifications as well as smart operation, fast response, easy modularization, plus user-friendly and user-defined function keys. With Self-Tuning and FUZZY temperature control functions, controllers can be installed in open space and confined space applications and are capable of presenting a smooth temperature control curve. In addition, the innovative design enables customers to replace the module with new functions to attain the ultimate in extension flexibility.



Remote Control

Sets DT3 temperature via analog output of host controller

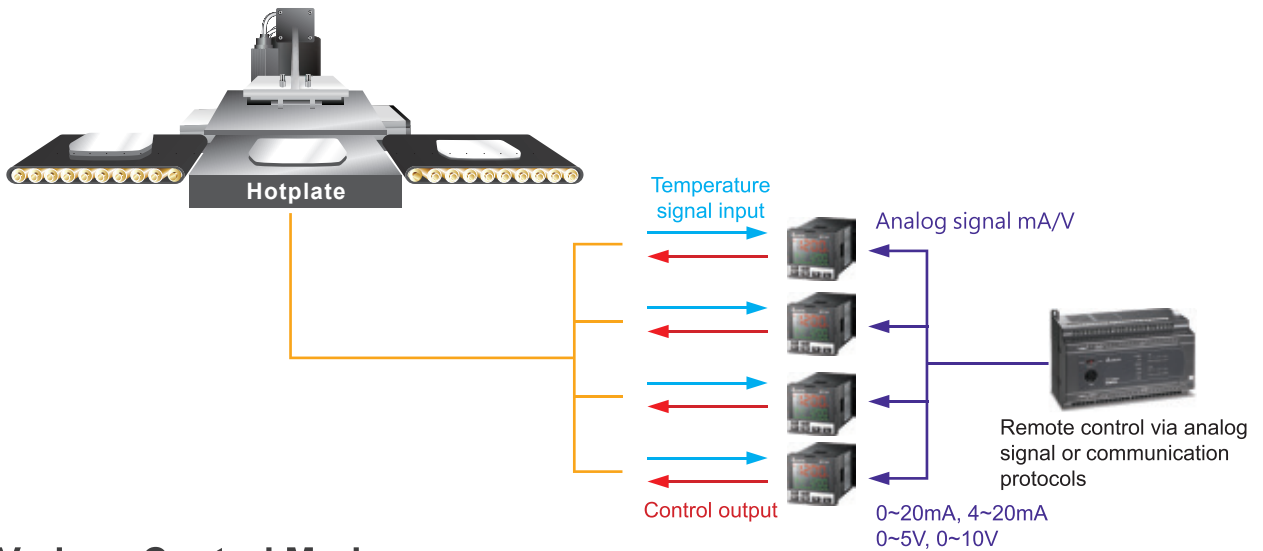

Various Control Modes

- ▶ Self Tuning
- ▶ FUZZY
- ▶ Auto-tuning
- ▶ ON/OFF
- ▶ Manual

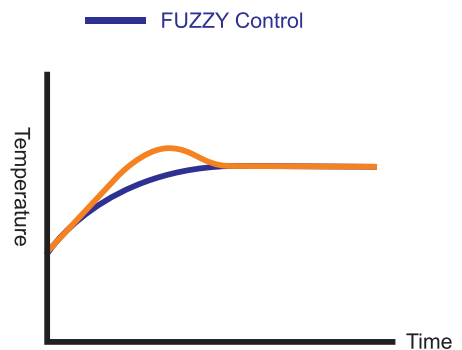
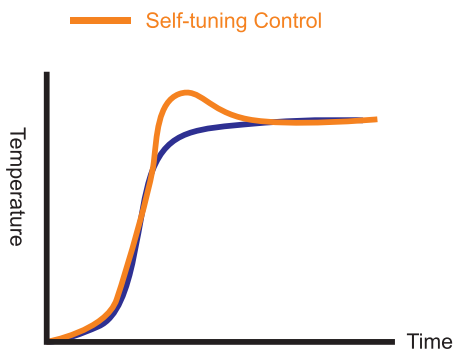

■ Extension Ability

Modular design of functional devices lets users replace the module as needed for application flexibility



■ Large 3-color LCD Display

The 1st 3-color LCD temperature controller in Taiwan.



■ Heater Disconnection Detection

Measurable up to 100A

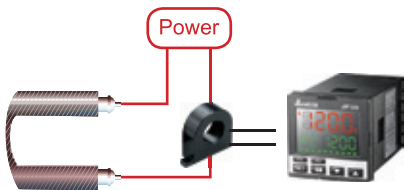

■ Retransmission Output

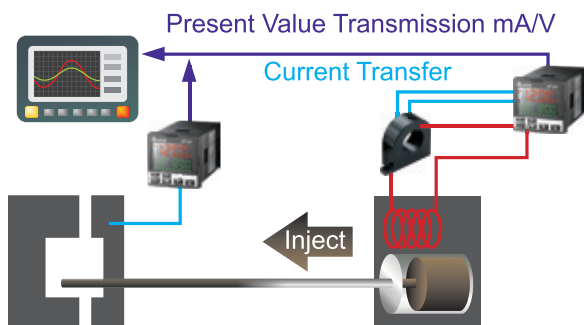

■ User-defined Function Keys

- ▶ Menu
- ▶ Auto-tuning
- ▶ Control modes selection
- ▶ RUN/STOP Mode
- ▶ Program hold



■ Point-to-point Control (Proportional Output mA/V)

Sets the Present Value by point-to-point control.



■ Dual Output Control

- ▶ Preset temperature is rapidly attained using two sets of outputs for heating and cooling control
- ▶ This function is used to automatically calculate two sets of PID parameters, one for heating and one for cooling

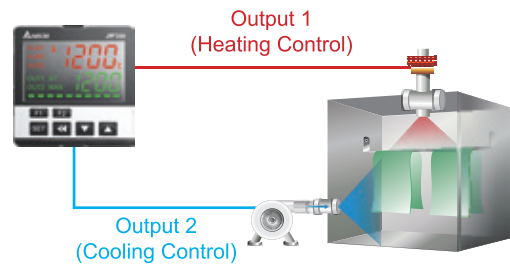

Specifications

Input power supply	AC 100 to 240V, 50/60Hz, DC 24V \pm 10%
Display method	LCD. Present Value: red, Set Value: green
Input sensors	Thermocouple: K, J, T, E, N, R, S, B, L, U, TXK
	Platinum RTD: Pt100, JPt100
	Analog input: 0 to 5 V, 0 to 10 V, 0 to 20 mA, 4 to 20 mA, 0 to 50 mV
Control modes	PID, PID programmable, FUZZY, Self-tuning, manual, ON/OFF
Display accuracy	0 or 1 digit to the right of the decimal point
Sampling rate	Analog input: 0.1s, Thermocouple or platinum RTD: 0.1s
Ambient temperature	0 ~ +50°C
Ambient humidity	35 to 80% RH (non-condensing)

Alarm Outputs

The DT3 offers 3 alarm outputs, and each alarm output has 18 alarm modes to choose from in the initial setting mode. When the target temperature exceeds or falls below the set point, the alarm output is enabled.

SV	Alarm Mode	Alarm Output Operation
0	Alarm function disabled	
1	Deviation upper- and lower-limit: This alarm output operates when PV value is higher than the set value SV + (AL - H) or lower than the set value SV - (AL - L).	
2	Deviation upper-limit: This alarm output operates when PV value is higher than the set value SV + (AL - H).	
3	Deviation lower-limit: This alarm output operates when PV value is lower than the set value SV - (AL - L).	
4	Absolute value upper- and lower-limit: This alarm output operates when PV value is higher than the set value AL - H or lower than the set value AL - L.	
5	Absolute value upper-limit: This alarm output operates when PV value is higher than the set value AL - H.	
6	Absolute value lower-limit: This alarm output operates when PV value is lower than the set value AL - L.	
7	Hysteresis upper-limit alarm output: This alarm output operates if PV value is higher than the set value SV + (AL - H). This alarm output is OFF when PV value is lower than the set value SV + (AL - L).	
8	Hysteresis lower-limit alarm output: This alarm output operates if PV value is lower than the set value SV - (AL - H). This alarm output is OFF when PV value is higher than the set value SV - (AL - L).	
9	Disconnection Alarm: This alarm output operates if the sensor connection is incorrect or has been disconnected.	
11	CT1 Alarm: CT1 is ON if the value of CT1 is lower than the value of AL - L or higher than AL - H.	
12	CT2 Alarm: CT2 is ON if the value of CT2 is lower than the value of AL - L or higher than AL - H.	
13	When SOAK status (temperature hold) happens to PID program control, alarm output is ON.	
14	When RAMP UP status happens to PID program control, alarm output is ON.	
15	When RAMP DOWN status happens to PID program control, alarm output is ON.	
16	When RUN status happens to PID program control, alarm output is ON.	
17	When HOLD status happens to PID program control, alarm output is ON.	
18	When STOP status happens to PID program control, alarm output is ON.	
19	When END status happens to PID program control, alarm output is ON.	

RS-485 Communication

DT3 supports baudrate 2,400 to 38,400 bps, MODBUS ASCII/RTU protocol, function code 03H and reads maximum 8 words from the register.

Address	Content	Definition
1000H	Present value (PV)	Measuring unit: 0.1 scale. The following values read mean error occurs. 8002H: Temperature not yet acquired 8003H: Not connected to sensor 8004H: Incorrect sensor
1001H	Set value (SV)	Measuring unit: 0.1 scale
1002H	Upper limit of temp. range	Cannot exceed the default value
1003H	Lower limit of temp. range	Cannot fall below the default value
1005H	Control mode	0: PID, 1: ON/OFF, 2: Manual, 3: FUZZY
1006H	Heating/ Cooling control	0: Heating/ Heating, 1: Cooling/ Heating, 2: Heating/ Cooling, 3: Cooling/ Cooling
1007H	1 st Heating/ Cooling control cycle	0.1 ~ 99 sec.
1008H	2 nd Heating/ Cooling control cycle	0.1 ~ 99 sec.
1009H	Proportional band (PB)	0.1 ~ 999.9
100AH	Ti value	0 ~ 9999
100BH	Td value	0 ~ 9999
1012H	Read/write Output 1 volume	Unit: 0.1%, only valid in manual control mode
1013H	Read/write Output 2 volume	Unit: 0.1%, only valid in manual control mode
1016H	Regulated temp. value	-99.9 ~ +99.9, Unit: 0.1
102AH	Read/write LED status	b0: ALM3, b1: ALM2, b2: °F, b3: °C, b4: ALM1, b5: OUT2, b6: OUT1, b7 : AT
102BH	Read/write key status	b0: Set, b1: Select, b2: Up, b3: Down, 0: Press it
102CH	Panel lockup status	0: Normal, 1: Fully locked, 11: SV adjustable
102DH	CT value	Unit: 0.1A
103BH	AT setting	0: OFF(default), 1: ON
103CH	Control RUN/STOP setting	0: STOP, 1: RUN (default), 2: END (program), 3: HOLD (program)

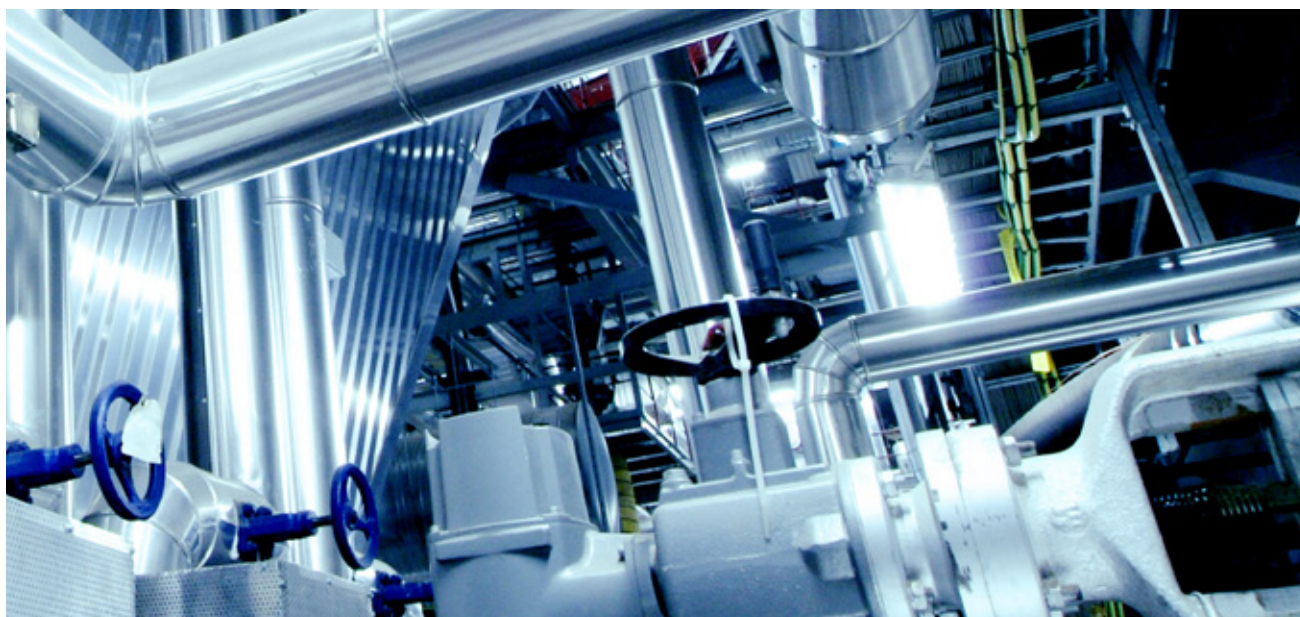

Parameters Operation

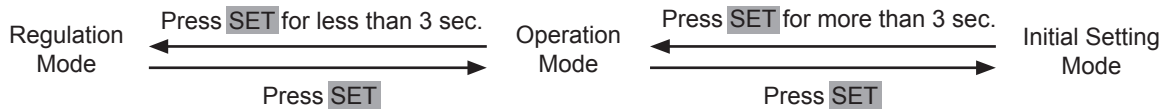

Regulation Mode	Operation Mode	Initial Setting Mode
AL Auto-tuning (when CTRL set in PID or FUZZY and in RUN mode) Press ◀ ▽	T34 Use ▲ ▼ to set up target temperature Press ◀ ▽	INPE Set up input type Press ◀ ▽
SE Self-tuning switch (set when in PID control and the TUNE parameter = ST)	R-S Control loop RUN or STOP	EPUN Set up temperature unit (not displayed when in analog input)
PcD Select the nth (n = 0 ~ 5) PID. When n = 6, PID is auto-selected.	PERN Set up start pattern (when in PID programmable control and PSLP)	EP-H Set up upper temperature limit
Pdof Set up PID control offset	SEEP Set up start step (when in programmable control)	EP-L Set up lower temperature limit
FZ-R Set up FUZZY gain value	SP Set up the position of decimal point	CTRL Select control modes
FZdb Set up FUZZY Deadband	LoL Lock the keys	CTRLS Select SV control modes
o1-S Adjust Output 1 hysteresis (when in ON/OFF control)	AL1H Set up upper limit of Alarm 1	WESV Set up waiting temperature (when in programmable control)
o2-S Adjust Output 2 hysteresis (when in ON/OFF control)	AL1L Set up lower limit of Alarm 1	W-EN Set up waiting time (when in programmable control)
o1-H o1-L Control cycle for Output 1 (except in ON/OFF control)	AL2H Set up upper limit of Alarm 2	SLoP Set up start slope (when in programmable control)
o2-H o2-L Control cycle for Output 2 (except in ON/OFF control)	AL2L Set up lower limit of Alarm 2	PR-EM Select pattern to be edited
CoEF Ratio of Output 1 against Output 2 when in dual output control (set when in PID and dual output control)	AL3H Set up upper limit of Alarm 3	EUNE Select AT or ST
DEAd Set up deadband (when in dual output)	AL3L Set up lower limit of Alarm 3	S-HC Select heating, cooling or dual output heating and cooling
PV-F Set up input filter factor	ALHP Record highest temperature of Alarm 1	AL1 AL2 AL3 Set up Alarm 1 mode
PV-R Set up input filter range	ALLP Record lowest temperature of Alarm 1	AL1o AL2o AL3o Set up Alarm 1 options
PVoF Adjust input compensation	R2HP Record highest temperature of Alarm 2	AL1d AL2d AL3d Set up Alarm 1 delay
PVGR Adjust input gain	R2LP Record lowest temperature of Alarm 2	o-EN Set up reverse alarm output
SVSL Set up rising slope (when CRTS = SLOP)	R3HP Record highest temperature of Alarm 3	RMEF Set up Remote type
ALMR Adjust upper limit compensation for analog Output 1*	R3LP Record lowest temperature of Alarm 3	EXEC Select auxiliary function

Regulation Mode	Operation Mode	Initial Setting Mode
RLM Adjust lower limit compensation for analog Output 1*	oUL1 Display and adjust Output 1 volume	CoSH Enable/disable communication write-in
RUM Adjust upper limit compensation for analog Output 2*	oUL2 Display and adjust Output 2 volume	C-SL Select ASCII or RTU format
R2ML Adjust lower limit compensation for analog Output 2*	o1MA Set up upper limit percentage for Output 1	C-Ad Set up communication address
R2MR Adjust upper limit compensation for Retransmission*	o1ML Set up lower limit percentage for Output 1	bPS Set up baudrate
R2ML Adjust lower limit compensation for Retransmission*	o2MR Set up upper limit percentage for Output 2	LEN Set up data length
RM-6 Adjust Remote gain	o2ML Set up lower limit percentage for Output 2	StoP Set up stop bit
RM-F Adjust Remote compensation	CL1 Display current measured at CT1	PRLY Set up parity bit
EVe1 Set up EVENT1 function	CL2 Display current measured at CT2 Press ◀ to return to set up target temperature	Press ◀ to return to set up input type
EVe2 Set up EVENT2 function		
EVe3 Set up EVENT3 function Press ◀ to return to auto-tuning		

*1 scale = 1μA; 1 scale = 1mV

PID mode: Any of the 6 PID groups can be selected. When n = 6, the program will automatically select the PID group that is the closest to the target temperature.

PcD Select the nth PID (n = 0 ~ 5) Press ◀ ▷ 0 ~ 5 th PID	SP0 Set up the 0 th PID temperature value Press ◀ ▾	SP5 Set up the 5 th PID temperature value Press ◀ ▾
	P0 Set up the 0 th proportional band value	P5 Set up the 5 th proportional band value
	T0 Set up the 0 th Ti value	T5 Set up the 5 th Ti value
	d0 Set up the 0 th Td value	d5 Set up the 5 th Td value
	CoFD Set up the 0 th PID integral deviation Press ◀ to return to PID deviation	CoFS Set up the 5 th PID integral deviation Press ◀ to return to PID deviation

Patterns and steps: Edit **PRo6** in **CLRL** parameter. Take editing pattern 0 for example:

PLRM Select the pattern number to be edited Select number ▷ Press ◀ ▾ to select OFF	SP00 Edit temperature for Step 0 Press ◀ ▾	PSY0 Select actual number of steps when the program is executing Press ◀ ▾
Exit pattern and step editing and switch to S-HC to continue the setup process	EM00 Edit time for Step 0 (time unit: hr, min)	CYCO Set up additional cycles (0 ~ 99) for the pattern execution
	Set up Step 0 ~ 15 in order	LCND Set up link pattern. OFF refers to the program end. Press ◀ to return to select the pattern number to be edited
	SP15 Edit temperature for Step 15 TM15 Edit time for Step 15 Press ◀ to set up actual step numbers	

Ordering Information

DT3

1 2 3 4 5 6 7 8

Series Name		Delta DT3 Series Temperature Controller	
1 2	Panel size (W x H)	20: 4848: 1/16 DIN W48 x H48 mm 30: 7272: W72 x H72mm	40: 4896: 1/8 DIN W48 x H96 mm 60: 9696: 1/4 DIN W96 x H96 mm
3	Output 1 options	R: Relay, 250 VAC, 5A V: Voltage pulse, 12V +10 to 20%	C: DC current, 4 to 20mA L: Linear voltage, 0 to 10 VDC
4	Power supply	A: AC 100 to 240V D: DC 24 V	
5	Output 2 options	R: Relay, 250 VAC, 5A V: Voltage pulse, 12V +10 to 20%	C: DC current, 4 to 20mA L: Linear voltage, 0 to 10 VDC
6	Optional function 1	0: None, 1: Event input 3, 2: RS-485 communication	
7	Optional function 2	0: None, 1: Event input 2, 2: CT input 2, 3: Retransmission output	
8	Optional function 3	0: None, 1: Event input 1, 2: CT input 1, 3: Remote setup input	

DT3 Accessories

D T 3 - 1

Accessories		Delta DT3 Series Temperature Controller	
1	Option 1	20ESTD: DT320 EXTENSION without RS-485 & EV3	R: Relay Output
		20ECOM: DT320 EXTENSION include RS-485	V: DC Voltage Pulse Output
		20EEV3: DT320 EXTENSION include EVENT3	C: DC Current Output
		40ESTD: DT340/DT360 EXTENSION without RS-485 & EV3	L: DC Linear Voltage Output
		40ECOM: DT340/360 EXTENSION include RS-485	EVENT: Event Input
		40EEV3: DT340/360 EXTENSION include EVENT3	CTI: CT Input
		DT330 is a replacement for DTA7272 (with basic function). It has less extension function. <ul style="list-style-type: none"> DT330 <input type="checkbox"/> A-0 has 1 output, 1 alarm output, and has no extension functions DT330 <input type="checkbox"/> A has 1 output, 2 alarm outputs, but no extension functions (similar to DTA7272 <input type="checkbox"/> 0) DT330 <input type="checkbox"/> A-0000 has extension board without communication function. Functional extension card is an optional part DT330 <input type="checkbox"/> A-0200 has 1 output, 2 alarm outputs, and has no extension functions. It supports RS-485 communication function (similar to DTA7272 <input type="checkbox"/> 1) 	
		REMOTE: Remote set point	
		CT30A: 30A CT	
		CT100A: 100A CT	

DTK

1 2 3 4 5 6 7

Series Name		Delta DTK Series Temperature Controller	
1 2 3 4	Panel size (W x H)	4848: W48 × H48mm 4896: W48 × H96mm	7272: W72 × H72mm
5	Output options	R: Relay, 250 VAC, 5A V: Voltage Pulse, 12 VDC +10~20%	C: DC Current Output 4 ~ 20 mA
6 7	Optional function	01: 1 Alarm output 02: 2 Alarm outputs	

DTA

1 2 3 4 5 6 - 7

Series Name		Delta DTA Series Temperature Controller	
1 2 3 4	Panel size (W x H)	4848: 1/16 DIN W48 x H48 mm 4896: 1/8 DIN W48 x H96 mm 9696: 1/4 DIN W96 x H96 mm	7272: W72 x H72 mm 9648: W96 x H48 mm
5	Output	R: Relay, SPST (4848: SPST), 250VAC, 5A V: Voltage pulse, 14V +10% ~ -20% (Max. 40mA)	C: Current, 4~20mA
6	Communication (optional)	0: N/A	1: RS-485 communication
7	CT (optional)	<input type="checkbox"/> : N/A	T: With CT (only DTA7272R0)



Dimensions

4824

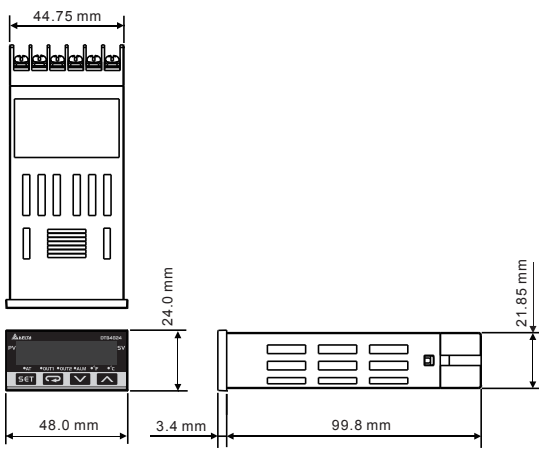

4896

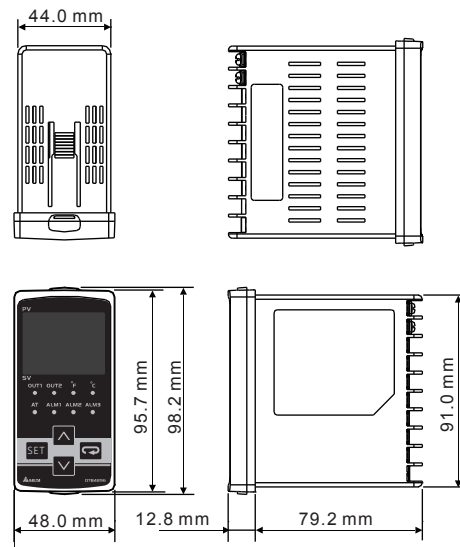

4848

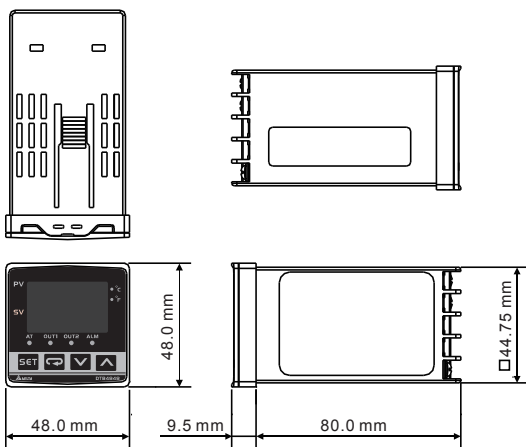

7272

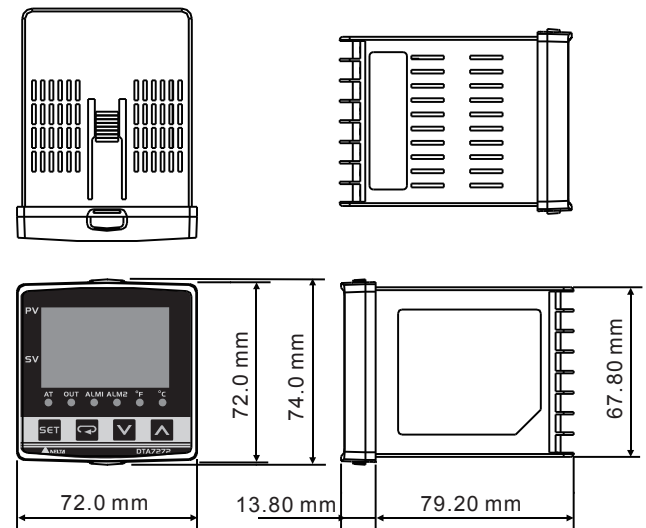



9648

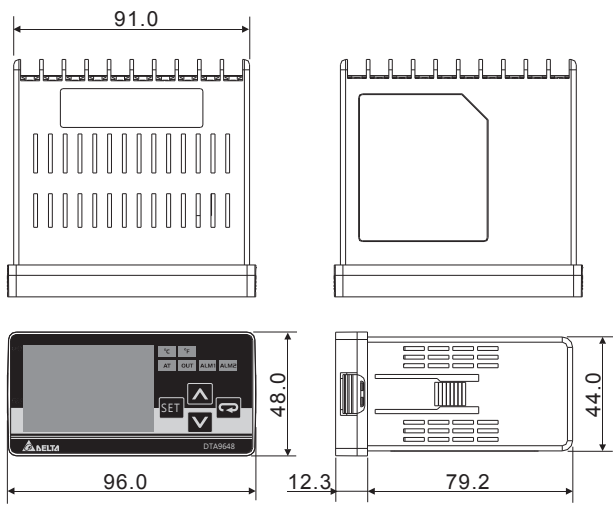

9696

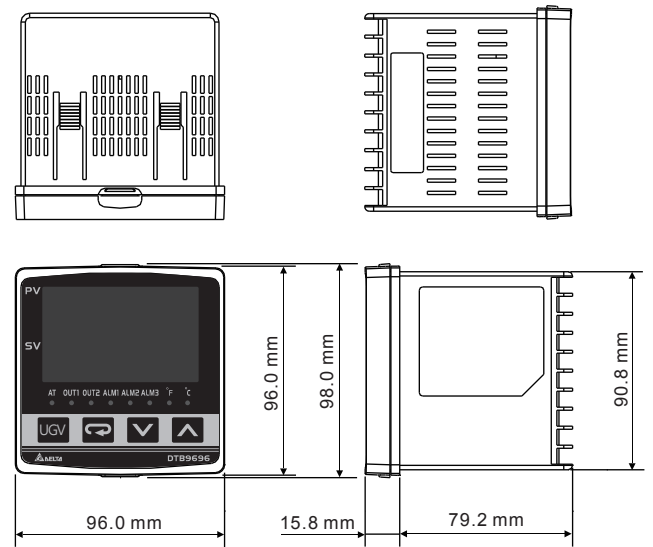

DTC

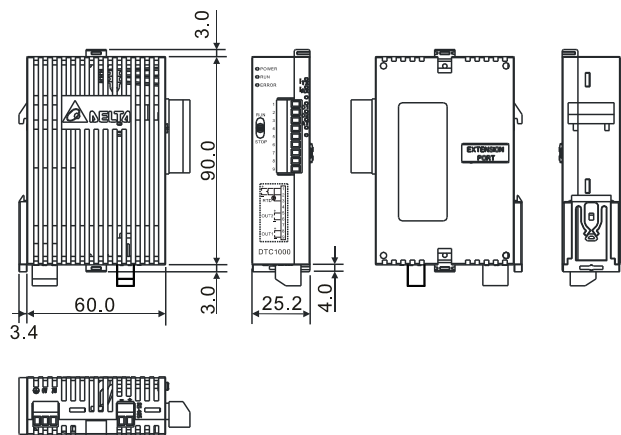

DTE

