

BX Series Long Sensing, Amplifier Built-in Type With Universal Voltage (terminal)

Terminal Type And Long Sensing Distance Type

■ Features

- Built-in sensitivity adjustment VR
- Timer function: ON Delay, OFF Delay, One-shot Delay
- NPN/PNP open collector output (DC power type)
- Self-diagnosis function (Green LED turns ON in stable level)
- Wide power supply range: Universal 24-240VDC/24-240VAC
- Protection structure IP66 (IEC standard)

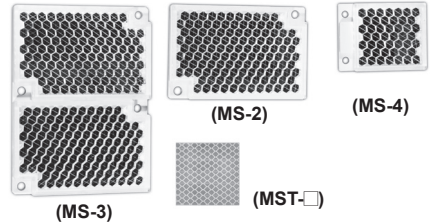

※MS-4, MST-□ is sold separately.

⚠ Please read "Caution for your safety" in operation manual before using.



■ Specifications

◎ Free power type, Relay contact output type

Model	Standard type	BX15M-TFR	BX5M-MFR	BX3M-PFR	BX700-DFR
	With Timer	BX15M-TFR-T	BX5M-MFR-T	BX3M-PFR-T	BX700-DFR-T
Sensing type		Through-beam	Retroreflective (Standard type)	Retroreflective (Built-in polarizing filter)	Diffuse reflective
Sensing distance		15m	0.1 to 5m (MS-2) ^{※1}	0.1 to 3m (MS-3) ^{※2}	700mm ^{※3}
Sensing target		Opaque materials of Min. Ø15mm	Opaque materials of Min. Ø60mm		Translucent, opaque material
Hysteresis		—			
Response time		Max. 20ms			
Power supply		24-240VAC ±10% 50/60Hz, 24-240VDC ±10% (Ripple P-P:Max. 10%)			
Power consumption		Max. 3VA			
Light source		Infrared LED (850nm)		Red LED (660nm)	Infrared LED (940nm)
Sensitivity adjustment		Built-in the adjustment VR			
Operation mode		Selectable Light ON or Dark ON by switch			
Control output		Relay contact output (Contact capacity: 30VDC 3A, 250VAC 3A at resistive load, Contact composition: 1c) ^{※4}			
Relay life cycle		Mechanically: Min. 50,000,000, Electrically: Min. 100,000			
Self-diagnosis output		Self-diagnosis indicator (green LED) turns on at stable operation			
Timer function		Selectable ON Delay, OFF Delay, One Shot Delay by slide switch [Delay Time: 0.1 to 5sec. (Adjustable VR)]			
Indicator		Operation indicator: yellow LED, Self-diagnosis indicator: green LED			
Connection		Terminal connection			
Insulation resistance		Min. 20MΩ (at 500VDC megger)			
Insulation type		Double or strong insulation (Mark: ) Dielectric voltage between the measured input and the power: 1.5kV)			
Noise resistance		±1,000V the square wave noise (pulse width: 1μs) by the noise simulator			
Dielectric strength		1500VAC 50/60Hz for 1minute			
Vibration	Mechanical	1.5mm amplitude at frequency of 10 to 55Hz (for 1 min.) in each X, Y, Z direction for 2 hours			
	Malfunction	1.5mm amplitude at frequency of 10 to 55Hz (for 1 min.) in each X, Y, Z direction for 10 minutes			
Shock	Mechanical	500m/s ² (approx. 50G) in each X, Y, Z direction for 3 times			
	Malfunction	100m/s ² (approx. 10G) in each X, Y, Z direction for 3 times			
Environment	Ambient illumination	Sunlight: Max. 11,000lx, Incandescent lamp: Max. 3,000lx (Receiver illumination)			
	Ambient temperature	-20 to 55°C, storage: -25 to 70°C			
	Ambient humidity	35 to 85%RH, storage: 35 to 85%RH			
Protection structure		IP66 (IEC standard)			
Material		Case, Lens cover: PC, Sensing part: Acrylic			
Accessory	Individual	—	Reflector (MS-2)	Reflector (MS-3)	—
	Common	VR adjustment driver, Mounting bracket, Bolts, Nuts			
Approval		CE			
Unit weight	TFR: Approx. 225g	MFR: Approx. 130g	PFR: Approx. 148g	DFR: Approx. 115g	
	TFR-T: Approx. 226g	MFR-T: Approx. 131g	PFR-T: Approx. 149g	DFR-T: Approx. 116g	

※1: It is the same when using the MS-4 reflector (sold separately). The sensor can detect under 0.1m.

※2: When using the MS-2 reflector, the sensing distance is 0.1 to 2m. The sensor can detect under 0.1m.

When using reflective tapes, the reflectivity will vary by the size of the tape. Please refer to the "Reflectivity By Reflective Tape Model" table before using the tapes.

※3: It is for Non-glossy white paper (200×200mm)

※4: Relay contact output of 1a type is option.

※Relay contact output of 1a type is option.

※The temperature or humidity mentioned in Environment indicates a non freezing or condensation environment.

(A) Photoelectric Sensors

(B) Fiber Optic Sensors

(C) Door/Area Sensors

(D) Proximity Sensors

(E) Pressure Sensors

(F) Rotary Encoders

(G) Connectors/Sockets

(H) Temperature Controllers

(I) SSRs / Power Controllers

(J) Counters

(K) Timers

(L) Panel Meters

(M) Tacho / Speed / Pulse Meters

(N) Display Units

(O) Sensor Controllers

(P) Switching Mode Power Supplies

(Q) Stepper Motors & Drivers & Controllers

(R) Graphic/Logic Panels

(S) Field Network Devices

(T) Software

BX Series

■ Specifications

◎ DC power type, Solid state output type

Model	Standard type	BX15M-TDT	BX5M-MDT	BX3M-PDT	BX700-DDT
	With Timer	BX15M-TDT-T	BX5M-MDT-T	BX3M-PDT-T	BX700-DDT-T
Sensing type		Through-beam	Retroreflective (Standard type)	Retroreflective (Built-in polarizing filter)	Diffuse reflective
Sensing distance		15m	0.1 to 5m (MS-2) ^{※1}	0.1 to 3m (MS-3) ^{※2}	700mm ^{※3}
Sensing target		Opaque materials of Min. Ø15mm	Opaque materials of Min. Ø60mm		Translucent, opaque material
Hysteresis		—			Max. 20% at rated setting distance
Response time		Max. 1ms			
Power supply		12-24VDC ±10% (Ripple P-P:Max. 10%)			
Current consumption		Max. 50mA			
Light source		Infrared LED (850nm)		Red LED (660nm)	Infrared LED (940nm)
Sensitivity adjustment		Built-in VR			
Operation mode		Selectable Light ON or Dark ON by switch			
Control output		NPN or PNP open collector output ●Load voltage: Max. 30VDC ●Load current: Max. 200mA ●Residual voltage - NPN:Max. 1V, PNP:Max. 2.5V			
Self-diagnosis output		NPN open collector output(Green LED turns on at stable operation and output (transistor output) turns on) ●Load voltage: Max. 30VDC ●Load current: Max. 50mA ●Residual voltage - Max. 1V(50mA), PNP: 0.4V(16mA)			
Protection circuit		Reverse polarity protection, Short-circuit protection			
Timer function		Selectable ON Delay, OFF Delay, One Shot Delay by slide switch [Delay Time: 0.1 to 5sec. (Adjustable VR)]			
Indicator		Operation indicator: yellow LED, Self-diagnosis indicator: green LED			
Connection		Terminal connection			
Insulation resistance		Min. 20MΩ (at 500VDC megger)			
Noise resistance		±240V the square wave noise (pulse width: 1μs) by the noise simulator			
Dielectric strength		1500VAC 50/60Hz for 1minute			
Vibration	Mechanical	1.5mm amplitude at frequency of 10 to 55Hz (for 1 min.) in each X, Y, Z direction for 2 hours			
	Malfunction	1.5mm amplitude at frequency of 10 to 55Hz (for 1 min.) in each X, Y, Z direction for 10 minutes			
Shock	Mechanical	500m/s ² (approx. 50G) in each X, Y, Z direction for 3 times			
	Malfunction	100m/s ² (approx. 10G) in each X, Y, Z direction for 3 times			
Environment	Ambient illumination	Sunlight: Max. 11,000lx, Incandescent lamp: Max. 3,000lx (Receiver illumination)			
	Ambient temperature	-20 to 55°C, storage: -25 to 70°C			
	Ambient humidity	35 to 85%RH, storage: 35 to 85%RH			
Protection structure		IP66 (IEC standard)			
Material		Case, Lens cover: PC, Sensing part: Acrylic			
Accessory	Individual	—	Reflector (MS-2)	Reflector (MS-3)	—
	Common	VR adjustment driver, Mounting bracket, Bolts, Nuts			
Approval		CE			
Unit weight		TDT: Approx. 211g	MDT: Approx. 123g	PDT: Approx. 141g	DDT: Approx. 116g
		TDT-T: Approx. 212g	MDT-T: Approx. 124g	PDT-T: Approx. 142g	DDT-T: Approx. 117g

※1: It is the same when using the MS-4 reflector (sold separately). The sensor can detect under 0.1m.

※2: When using the MS-2 reflector, the sensing distance is 0.1 to 2m. The sensor can detect under 0.1m.

When using reflective tapes, the reflectivity will vary by the size of the tape. Please refer to the "Reflectivity By Reflective Tape Model" table before using the tapes.

※3: It is for Non-glossy white paper (200×200mm)

※The temperature or humidity mentioned in Environment indicates a non freezing or condensation environment.

Long Sensing, Amplifier Built-in Type With Universal Voltage (terminal)

Feature Data

Through-beam type

- BX15M-TFR / BX15M-TFR-T
- BX15M-TDT / BX15M-TDT-T

Diffuse reflective type

- BX700-DFR / BX700-DFR-T
- BX700-DDT / BX700-DDT-T

Parallel shifting characteristic		Angle Characteristic		Sensing area	
Measuring method	Data	Measuring method	Data	Measuring method	Data
<p>Receiver</p> <p>Emitter</p> <p>Sensing distance L (m)</p> <p>Left ← Center → Right</p> <p>Sensing area (cm)</p>		<p>Receiver</p> <p>Emitter</p> <p>Sensing distance L (m)</p> <p>Left ← Center → Right</p> <p>Operation angle (θ)</p>		<p>Standard sensing target: non-glossy white paper 200x200mm</p> <p>Diffuse reflective</p> <p>Sensing distance L (m)</p> <p>Left ← Center → Right</p> <p>Sensing area (mm)</p>	

Retroreflective type

- BX5M-MFR / BX5M-MFR-T
- BX5M-MDT / BX5M-MDT-T

Parallel shifting characteristic		Angle Characteristic		Reflector angle characteristic	
Measuring method	Data	Measuring method	Data	Measuring method	Data
<p>Reflector (MS-2)</p> <p>Retroreflective type (standard type)</p> <p>Sensing distance L (m)</p> <p>Left ← Center → Right</p> <p>Sensing area (mm)</p>		<p>Reflector (MS-2)</p> <p>Retroreflective type (standard type)</p> <p>Sensing distance L (m)</p> <p>Left ← Center → Right</p> <p>Operation angle (θ)</p>		<p>Reflector (MS-2)</p> <p>Retroreflective type (standard type)</p> <p>Sensing distance L (m)</p> <p>Left ← Center → Right</p> <p>Operation angle (θ)</p>	

Retroreflective type (Built-in polarizing filter)

- BX3M-PFR / BX3M-PFR-T
- BX3M-PDT / BX3M-PDT-T

Parallel shifting characteristic		Sensor angle characteristic		Reflector angle characteristic	
Measuring method	Data	Measuring method	Data	Measuring method	Data
<p>Reflector (MS-3)</p> <p>Retroreflective type (Built-in polarizing filter)</p> <p>Sensing distance L (m)</p> <p>Left ← Center → Right</p> <p>Sensing area (mm)</p>		<p>Reflector (MS-3)</p> <p>Retroreflective type (Built-in polarizing filter)</p> <p>Sensing distance L (m)</p> <p>Left ← Center → Right</p> <p>Operation angle (θ)</p>		<p>Reflector (MS-3)</p> <p>Retroreflective type (Built-in polarizing filter)</p> <p>Sensing distance L (m)</p> <p>Left ← Center → Right</p> <p>Operation angle (θ)</p>	

(A) Photoelectric Sensors

(B) Fiber Optic Sensors

(C) Door/Area Sensors

(D) Proximity Sensors

(E) Pressure Sensors

(F) Rotary Encoders

(G) Connectors/Sockets

(H) Temperature Controllers

(I) SSRs / Power Controllers

(J) Counters

(K) Timers

(L) Panel Meters

(M) Tacho / Speed / Pulse Meters

(N) Display Units

(O) Sensor Controllers

(P) Switching Mode Power Supplies

(Q) Stepper Motors & Drivers & Controllers

(R) Graphic/Logic Panels

(S) Field Network Devices

(T) Software

BX Series

■ Control Output Diagram

◎ Free power type (Relay contact output)

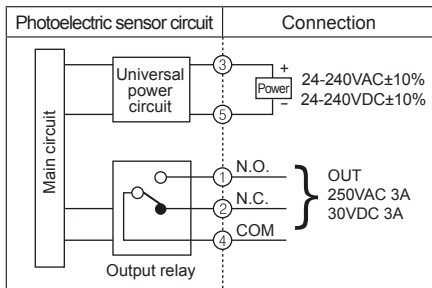

◎ DC power type (NPN/PNP open collector simultaneous output)

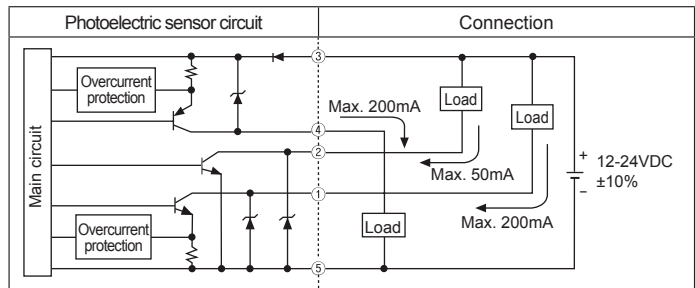

※ In case of product with the output protection device, if terminals of control output are short-circuited or overcurrent condition exists, the control output will turn off due to protection circuit.

■ Operation Timing Diagram

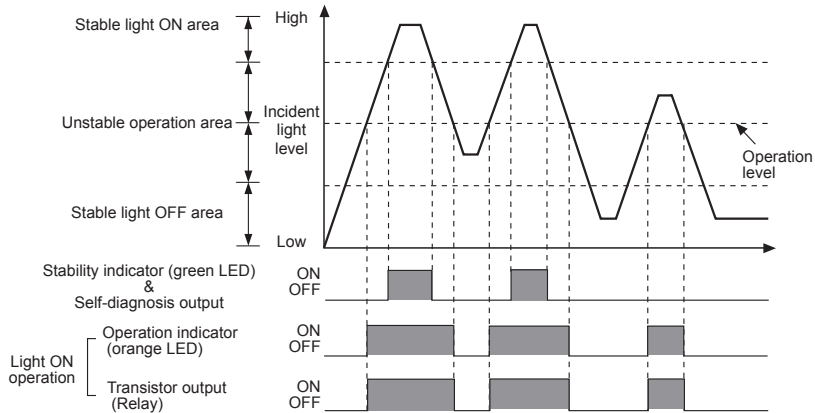

※ The waveforms of "Operation indicator" and "Transistor output" are for Light ON operation. They are opposite operation for Dark ON operation.
 ※ If the control output terminal is short-circuit or over current than the rated current flows in the unit, the sensor does not operate normally by protection circuit.

■ Timer Mode

Timer mode	Switch position		Status of light	Received light	Interrupted light
	S1	S2			
Normal	ON	ON	Light ON	ON	[ON pulse]
			Dark ON	OFF	[OFF pulse]
One-shot Delay	ON	OFF	Light ON	ON	[ON pulse with delay T]
			Dark ON	OFF	[OFF pulse with delay T]
ON Delay	OFF	ON	Light ON	ON	[ON pulse with delay T]
			Dark ON	OFF	[OFF pulse with delay T]
OFF Delay	OFF	OFF	Light ON	ON	[ON pulse with delay T]
			Dark ON	OFF	[OFF pulse with delay T]

※ T: Time can be set by the timer adjustment VR.
 ※ Conversion to other timer modes is applied after a former mode is finished.

Long Sensing, Amplifier Built-in Type With Universal Voltage (terminal)

■ Connections

◎ Through-beam type

● BX15M-TFR1

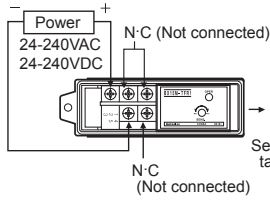

● BX15M-TFR2 BX15M-TFR2-T

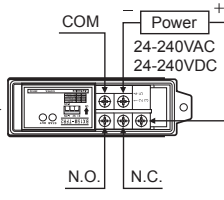

● BX15M-TDT1

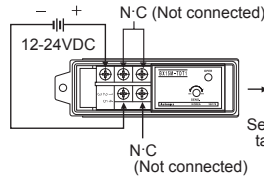

● BX15M-TDT2 BX15M-TDT2-T

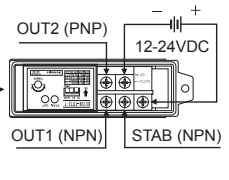

◎ Retroreflective type / Retroreflective type with polarizing filter

● BX5M-MFR, BX5M-MFR-T (Standard type)

● BX3M-PFR, BX3M-PFR-T (Built-in polarizing filter)

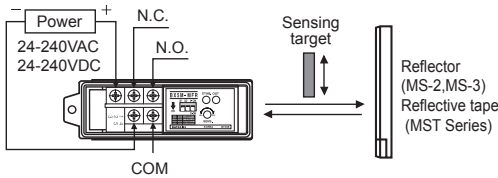

● BX5M-MDT, BX5M-MDT-T (Standard type)

● BX3M-PDT, BX3M-PDT-T (Built-in polarizing filter)

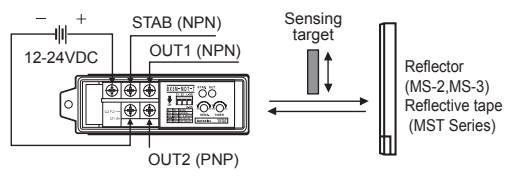

◎ Diffuse reflective type

● BX700-DFR, BX700-DFR-T

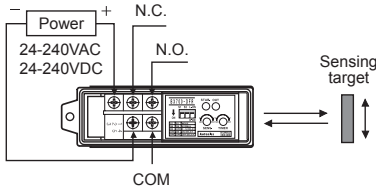

● BX700-DDT, BX700-DDT-T

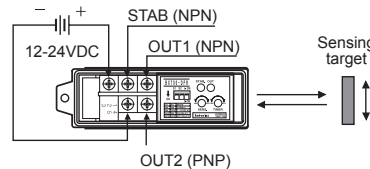

◎ Cable

(unit: mm)

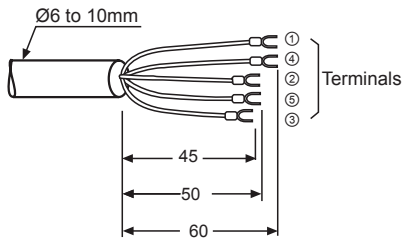

● Crimp terminal size

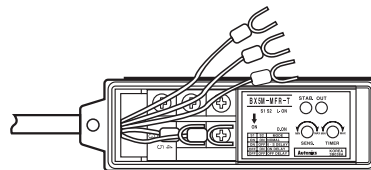
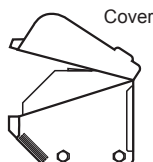
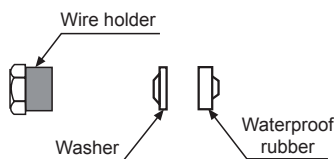
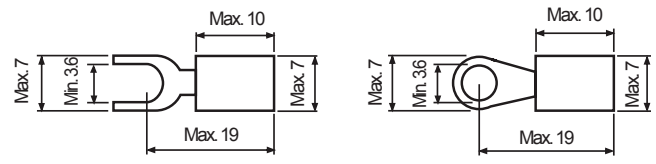

※ To connect the wires on the terminal, following as above figures.

※ Select the round wire with the size of Ø6 to 10mm for the waterproof and tighten the cable holder by torque of 1.0 to 1.5N·m.

※ To connect the wires on the terminal, tighten screws by torque of 0.8N·m.

(A) Photoelectric Sensors

(B) Fiber Optic Sensors

(C) Door/Area Sensors

(D) Proximity Sensors

(E) Pressure Sensors

(F) Rotary Encoders

(G) Connectors/ Sockets

(H) Temperature Controllers

(I) SSRs / Power Controllers

(J) Counters

(K) Timers

(L) Panel Meters

(M) Tacho / Speed / Pulse Meters

(N) Display Units

(O) Sensor Controllers

(P) Switching Mode Power Supplies

(Q) Stepper Motors & Drivers & Controllers

(R) Graphic/ Logic Panels

(S) Field Network Devices

(T) Software

BX Series

■ Front Panel Identification

◎ Through-beam type

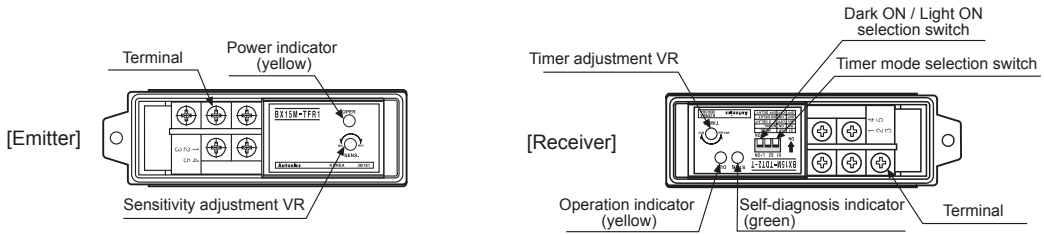

◎ Retroreflective type (Standard type, Built-in polarizing filter)

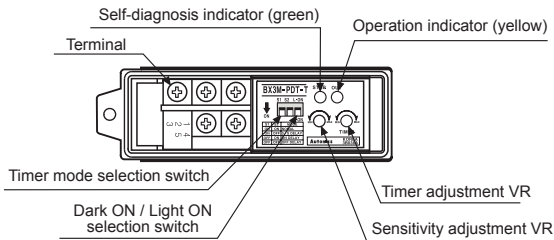

◎ Diffuse reflective type

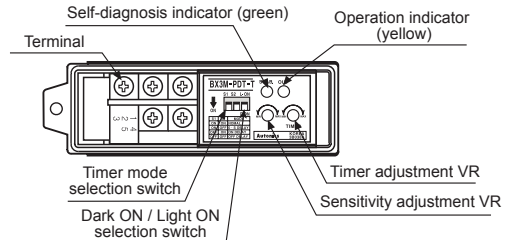

※There are no Timer mode selection switch and the timer adjustment VR in no timer function type.

■ Dimensions

(unit: mm)

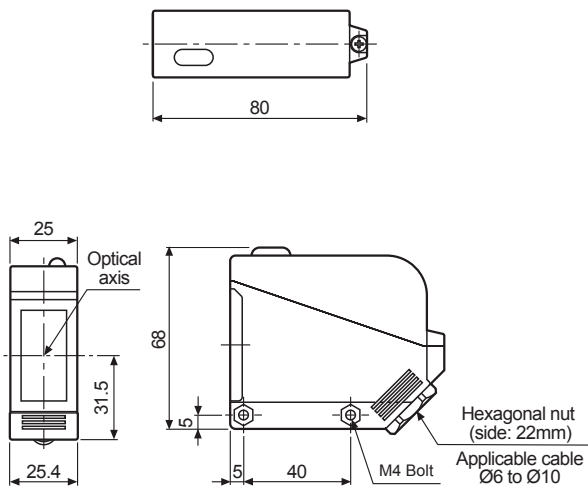

● Connect the bracket

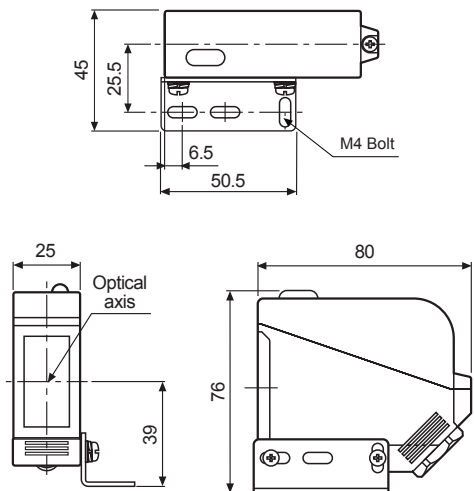

Long Sensing, Amplifier Built-in Type With Universal Voltage (terminal)

■ Dimensions

(unit: mm)

● Bracket

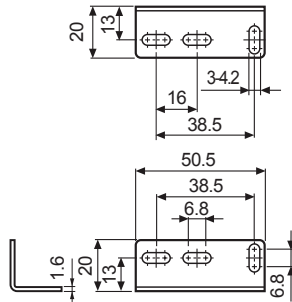

● Reflector

• MS-2

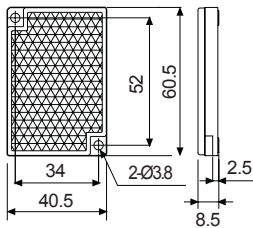

• MS-3 (sold separately)

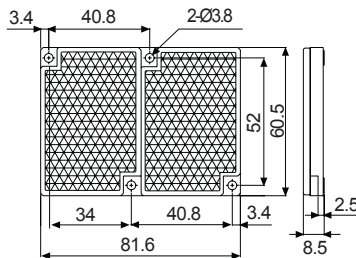

• MS-4 (sold separately)

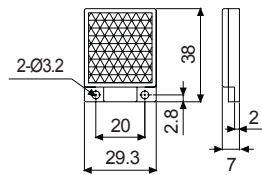

● Reflective tape (sold separately)

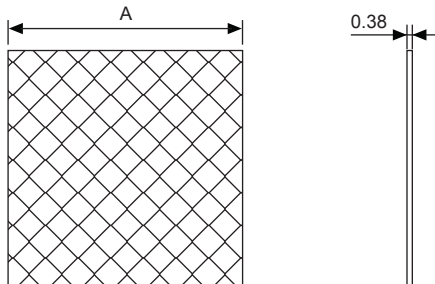

(unit: mm)

	A
MST-50-10	□50
MST-100-5	□100
MST-200-2	□200

■ Mounting And Sensitivity Adjustment

◎ Through-beam type

1. Supply the power to the photoelectric sensor, after setting the emitter and the receiver facing each other.
2. Set the receiver in center of position in the middle of the operation range of indicator by adjusting the receiver or the emitter right and left, up and down.
3. After the adjustment, check the stability of operation by putting the object at the optical axis.

※If the sensing target is translucent body or smaller than $\varnothing 15\text{mm}$, it can be missed by sensor because light penetrate it.

※Sensitivity adjustment: Refer to the diffuse reflective type's.

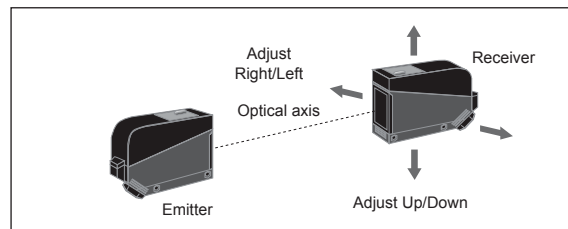

(A) Photoelectric Sensors

(B) Fiber Optic Sensors

(C) Door/Area Sensors

(D) Proximity Sensors

(E) Pressure Sensors

(F) Rotary Encoders

(G) Connectors/ Sockets

(H) Temperature Controllers

(I) SSRs / Power Controllers

(J) Counters

(K) Timers

(L) Panel Meters

(M) Tacho / Speed / Pulse Meters

(N) Display Units

(O) Sensor Controllers

(P) Switching Mode Power Supplies

(Q) Stepper Motors & Drivers & Controllers

(R) Graphic/ Logic Panels

(S) Field Network Devices

(T) Software

BX Series

◎ Diffuse reflective type

1. The sensitivity should be adjusted depending on a sensing target or mounting place.
 2. Set the target at a position to be detected by the beam, then turn the adjustment VR until position ① where the operation indicator (yellow LED) turns ON and the self-diagnosis indicator (green LED) turns OFF from min. position of the adjustment VR.
 3. Take the target out of the sensing area, then turn the adjustment VR until position ② where the operation indicator (yellow LED) turns OFF and the self-diagnosis indicator (green LED) turns ON. If the indicators do not operate, max. position is ③.
 4. Set the adjustment VR at the center of two switching position ①, ②.
- ※Above sensitivity adjustment is for Light ON mode. If it is for Dark ON mode, operation indicator (yellow LED) operates opposite.
- ※The sensing distance indicated on specification chart is for 200×200mm of non-glossy white paper. Be sure that it can be different by size, surface and gloss of target.

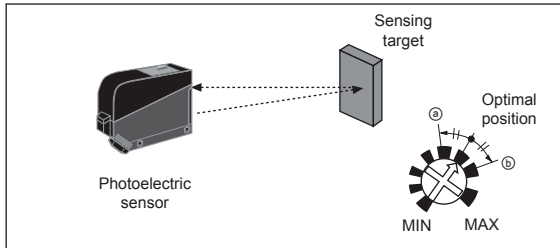

◎ Retroreflective type

1. Supply the power to the photoelectric sensor, after setting the photoelectric sensor and the reflector or reflective tape face to face.
 2. Set the photoelectric sensor in the position which indicator turns on, by adjusting the reflector (or reflective tape) or the sensor right and left, up and down.
 3. Fix both units tightly after checking that the unit detects the target.
- ※If using more than 2 photoelectric sensors in parallel, the space among them should be more than 30cm.
- ※If reflectance of target is higher than non-glossy white paper, it might cause malfunction by reflection from the target when the target is near to photoelectric sensor. Therefore put enough space between the target and the photoelectric sensor or the surface of the target should be installed at angle of 30° to 45° against optical axis. (When a sensing target with high reflectance near by, photoelectric sensing with the polarizing filter should be used.)
- ※Sensitivity adjustment: Refer to the diffuse reflective type's.

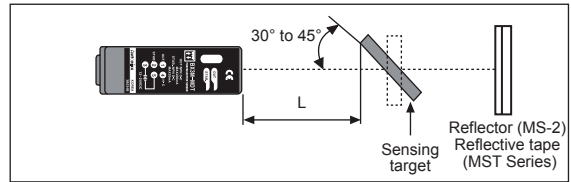
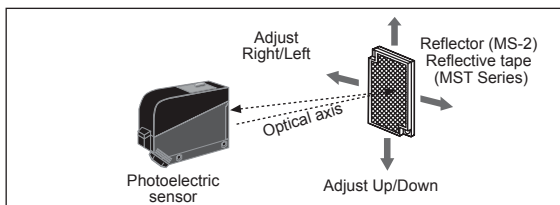

※If the mounting place is too narrow, please use MS-4 instead of MS-2.

※Please use reflective tape (MST Series) for where a reflector is not installed.

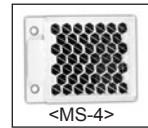

◎ Retroreflective type (Built-in polarizing filter)

The light passed through the polarizing filter of the emitter reaches to the MS-3 reflector or reflective tape converting as horizontal direction. It reaches to the receiver element of polarizing filter converting as vertical by the MS-3 reflector or reflective tape. Therefore, this type can also detect reflective mirror.

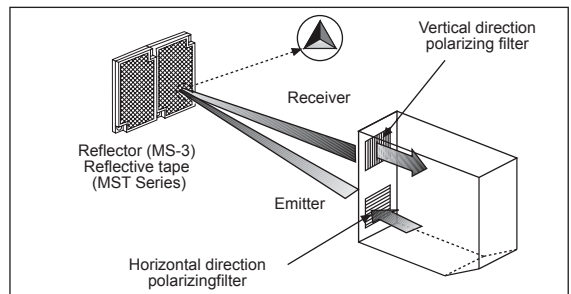

※Please use reflective tape (MST Series) for where a reflector is not installed.

■ Reflectivity By Reflective Tape Model

	Standard	Built-in polarizing filter
MST-50-10 (50×50mm)	90%	30%
MST-100-5 (100×100mm)	100%	40%
MST-200-2 (200×200mm)	110%	60%

※This reflectivity is based on the reflector (MS-2).

※Reflectivity may vary depending on usage environment and installation conditions.

The sensing distance and minimum sensing target size increase as the size of the tape increases.

Please check the reflectivity before using reflective tapes.

※For using reflective tape, installation distance should be min. 20mm.