

# ATN Series

## DIN W48×H48mm, Universal Voltage Multi-Function Timer

### ■ Features

- Realization of wide range of power supply  
:100-240VAC 50/60Hz, 24-240VDC universal,  
24VAC 50/60Hz, 24VDC universal, 12VDC
- Various output operation (6 kinds modes)
- Multi time range (16 kinds of time range)
- Wide control time (0.05sec to 100hour)
- Easy setting of time, time range, output operation mode
- Easy to check output status by indicator



⚠ Please read "Safety Considerations" in operation manual before using.



### ■ Ordering Information

<b>AT</b>	<b>8</b>	<b>N</b>	-	
Item				
Number of plug pins				
Time operation				
Power supply				
				No mark
				1
				2
		N		
		DN		
		EN		
	8			
	11			
		AT		

※8-pin socket (PG-08, PS-08(N), PS-08) and 11-pin socket (PG-11, PS-11(N)) are sold separately.

### ■ Specifications

Model	AT8N-□	AT11DN-□	AT11EN-□
Function	Multi Function Timer		
Control time setting range※1	0.05sec to 100hour		
Power supply	• 100-240VAC~ 50/60Hz, 24-240VDC≡ universal • 24VAC~ 50/60Hz, 24VDC≡ universal • 12VDC≡		
Allowable voltage range	90 to 110% of rated voltage		
Power consumption	<ul style="list-style-type: none"> <li>• Max. 4.3VA (100-240VAC~), Max. 2W (24-240VDC≡)</li> <li>• Max. 4.5VA (24VAC~), Max. 2W (24VDC≡)</li> <li>• Max. 1.5W (12VDC≡)</li> </ul>	<ul style="list-style-type: none"> <li>• Max. 3.5VA (100-240VAC~), Max. 1.5W (24-240VDC≡)</li> <li>• Max. 4VA (24VAC~), Max. 1.5W (24VDC≡)</li> <li>• Max. 1W (12VDC≡)</li> </ul>	<ul style="list-style-type: none"> <li>• Max. 4.3VA (100-240VAC~), Max. 2W (24-240VDC≡)</li> <li>• Max. 4.5VA (24VAC~), Max. 2W (24VDC≡)</li> <li>• Max. 1.5W (12VDC≡)</li> </ul>
Return time	Max. 100ms		
Timing operation	Power ON Start	Signal ON Start	
Min. input signal width	—	INHIBIT, START, RESET: Approx. 50ms	
Input	—	INHIBIT, START, RESET: [No-voltage input] - Short-circuit impedance: Max. 1kΩ, Residual voltage: Max. 0.5V, Open-circuit impedance: Min. 100kΩ	
Control output	Contact type	Time limit DPDT (2c) or Instantaneous SPDT (1c)+ Time limit SPDT (1c) selectable by output operation mode	Time limit DPDT (2c) Instantaneous SPDT (1c)+ Time limit SPDT (1c)
	Contact capacity	250VAC~ 5A, 30VDC≡ 5A resistive load	250VAC~ 5A, 24VDC≡ 5A resistive load
Relay life cycle	Mechanical	Min. 10,000,000 operations	
	Electrical	Min. 100,000 operations (250VAC 5A resistive load)	
Repeat error	Max. ±0.2% ±10ms		
SET error	Max. ±5% ±50ms		
Voltage error	Max. ±0.5%		
Temperature error	Max. ±2%		
Insulation resistance	Over 100MΩ (at 500VDC megger)		

※1: Refer to time specifications for control time setting range by model.

# Multi Function Analog Timer

## Specifications

Model	AT8N-□	AT11DN-□	AT11EN-□
Dielectric strength	2,000VAC 50/60Hz for 1 minute		
Noise immunity	AT□□-1	±500V the square wave noise (pulse width 1μs) by noise simulator	
	AT□□-2	±500V the square wave noise (pulse width 1μs) by noise simulator	
	AT□□	±2kV the square wave noise (pulse width 1μs) by noise simulator	
Vibration	Mechanical	0.75mm amplitude at frequency of 10 to 55Hz (for 1min) in each X, Y, Z direction for 1hour	
	Malfunction	0.5mm amplitude at frequency of 10 to 55Hz (for 1min) in each X, Y, Z direction for 10min	
Shock	Mechanical	300m/s <sup>2</sup> (approx. 30G) in each X, Y, Z direction 3 times	
	Malfunction	100m/s <sup>2</sup> (approx. 10G) in each X, Y, Z direction 3 times	
Environment	Ambient temperature	-10 to 55°C, storage: -25 to 65°C	
	Ambient humidity	35 to 85%RH, storage: 35 to 85%RH	
Approval	CE  us		
Accessory	Bracket		
Weight <sup>※2</sup>	Approx. 134.12g (approx. 86.71g)	Approx. 132.2g (approx. 85g)	Approx. 134.7g (approx. 87.5g)

※2: The weight includes packaging. The weight in parenthesis is for unit only.

※Environment resistance is rated at no freezing or condensation.

## Connections

### ○ AT8N

- When selecting [A], [F] output operation mode

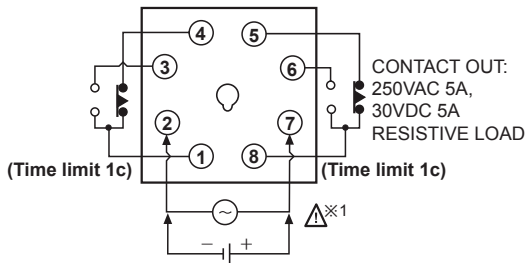

※1: AC/DC voltage: 100-240VAC 50/60Hz, 24-240VDC  
: 24VAC 50/60Hz, 24VDC  
DC voltage: 12VDC

- When selecting [A1], [B], [F1], [I] output operation mode

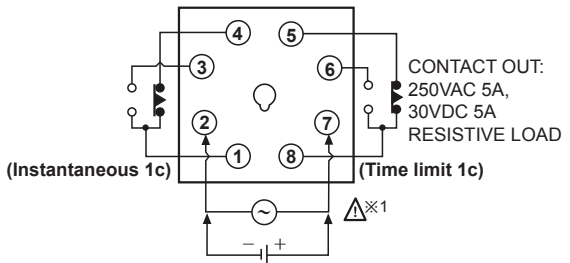

### ○ AT11DN

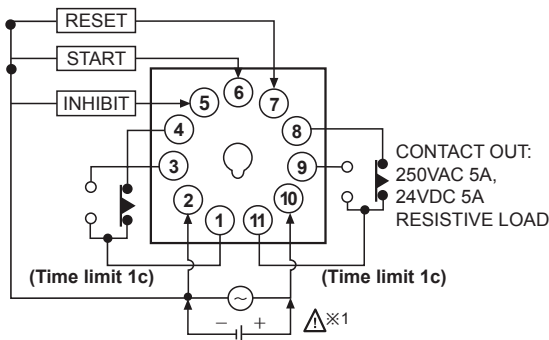

※1: AC/DC voltage: 100-240VAC 50/60Hz, 24-240VDC  
: 24VAC 50/60Hz, 24VDC  
DC voltage: 12VDC

### ○ AT11EN

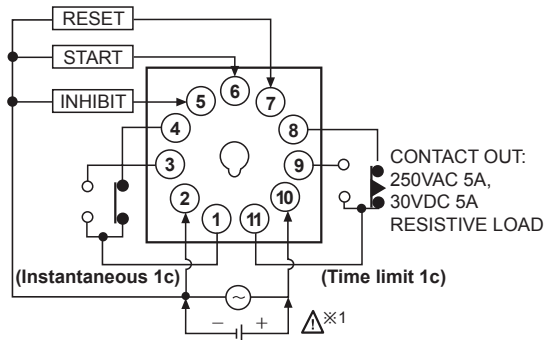

(A) Photoelectric Sensors
(B) Fiber Optic Sensors
(C) Door/Area Sensors
(D) Proximity Sensors
(E) Pressure Sensors
(F) Rotary Encoders
(G) Connectors/ Connector Cables/ Sensor Distribution Boxes/Sockets
(H) Temperature Controllers
(I) SSRs / Power Controllers
(J) Counters
(K) Timers
(L) Panel Meters
(M) Tacho / Speed / Pulse Meters
(N) Display Units
(O) Sensor Controllers
(P) Switching Mode Power Supplies
(Q) Stepper Motors & Drivers & Controllers
(R) Graphic/ Logic Panels
(S) Field Network Devices
(T) Software

# ATN Series

## ■ Dimensions

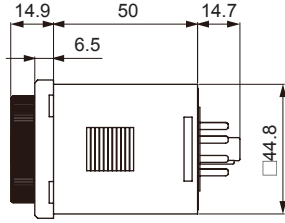
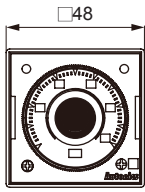

(unit: mm)

## ○ Bracket

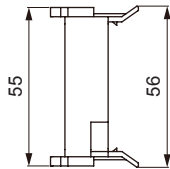
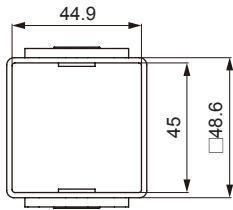
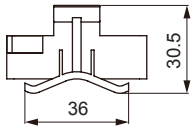

## ○ Panel cut-out

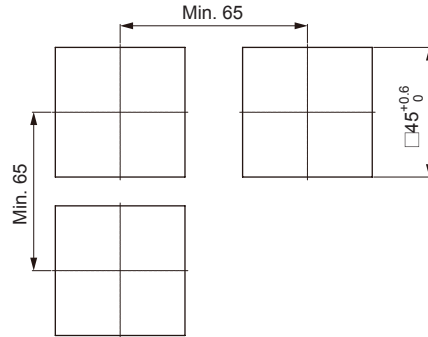

## ■ Unit Description

Operation/Power indicator  
(Flashes for timer operation,  
Turns ON for timer stop)

Time range indication

Time range setting switch

Time unit indication  
(SEC, MIN, HOUR, 10H mode)

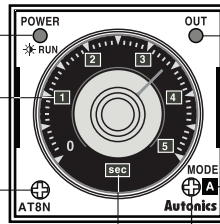

Time limit output indication

Output operation mode display part

**AT8N**  
(A, A1, B, F, F1, I mode)  
**AT11DN/AT11EN**  
(A, F, F1, C, D, I mode)

Output operation mode setting switch

## ■ Time Specifications

Time range	Time unit	Time setting range	Time range	Time unit	Time setting range
0.5	SEC	0.05 to 0.5sec	0.5	HOUR	0.05 to 0.5hour
1		0.1 to 1sec	1		0.1 to 1hour
5		0.5 to 5sec	5		0.5 to 5hour
10		1 to 10sec	10		1 to 10hour
0.5	MIN	0.05 to 0.5min	0.5	10H	0.5 to 5hour
1		0.1 to 1min	1		1 to 10hour
5		0.5 to 5min	5		5 to 50hour
10		1 to 10min	10		10 to 100hour

## ■ Output Operation Mode

### ● AT8N

Display	Output operation mode
A	Power ON Delay
A1	Power ON Delay1 (One-Shot output)
B	Power ON Delay2
F	Flicker (OFF Start)
F1	Flicker1 (ON Start)
I	Interval

### ● AT11DN/AT11EN

Display	Output operation mode
A	Signal ON Delay
F	Flicker (OFF Start)
F1	Flicker1 (ON Start)
C	Signal OFF Delay
D	Signal ON/OFF Delay
I	Interval

# Multi Function Analog Timer

## ■ Output Operation Mode (AT8N)

[t: Setting time,  $t > t-a$ , Rt: Return time,  $Rt1 > Rt$ ]

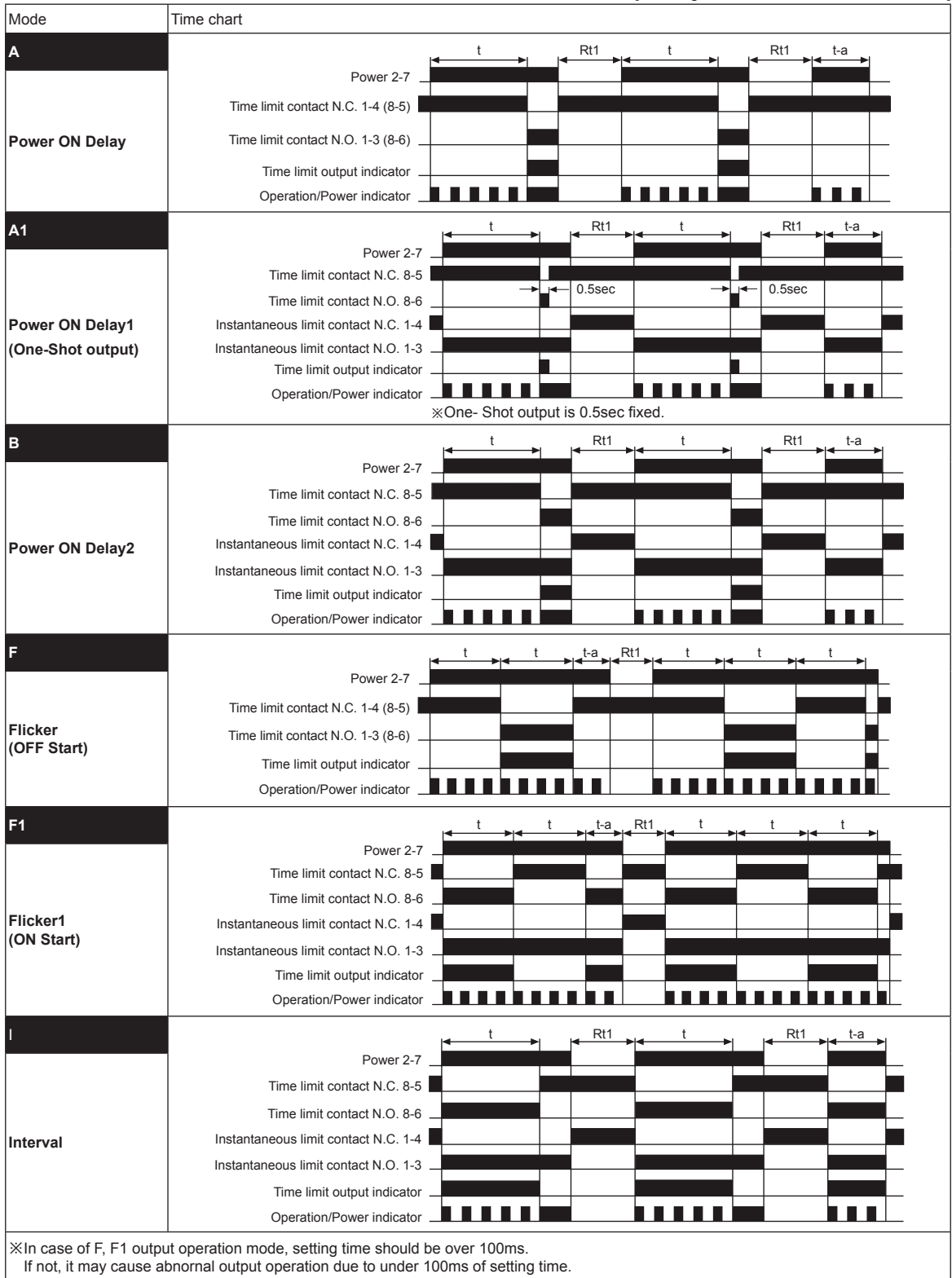

- (A) Photoelectric Sensors
- (B) Fiber Optic Sensors
- (C) Door/Area Sensors
- (D) Proximity Sensors
- (E) Pressure Sensors
- (F) Rotary Encoders
- (G) Connectors/ Connector Cables/ Sensor Distribution Boxes/Sockets
- (H) Temperature Controllers
- (I) SSRs / Power Controllers
- (J) Counters
- (K) Timers
- (L) Panel Meters
- (M) Tacho / Speed / Pulse Meters
- (N) Display Units
- (O) Sensor Controllers
- (P) Switching Mode Power Supplies
- (Q) Stepper Motors & Drivers & Controllers
- (R) Graphic/ Logic Panels
- (S) Field Network Devices
- (T) Software

## ■ Output Operation Mode (AT11DN/AT11EN)

[t: Setting time,  $t=t_1+t_2$ ,  $t>t-a$ ]

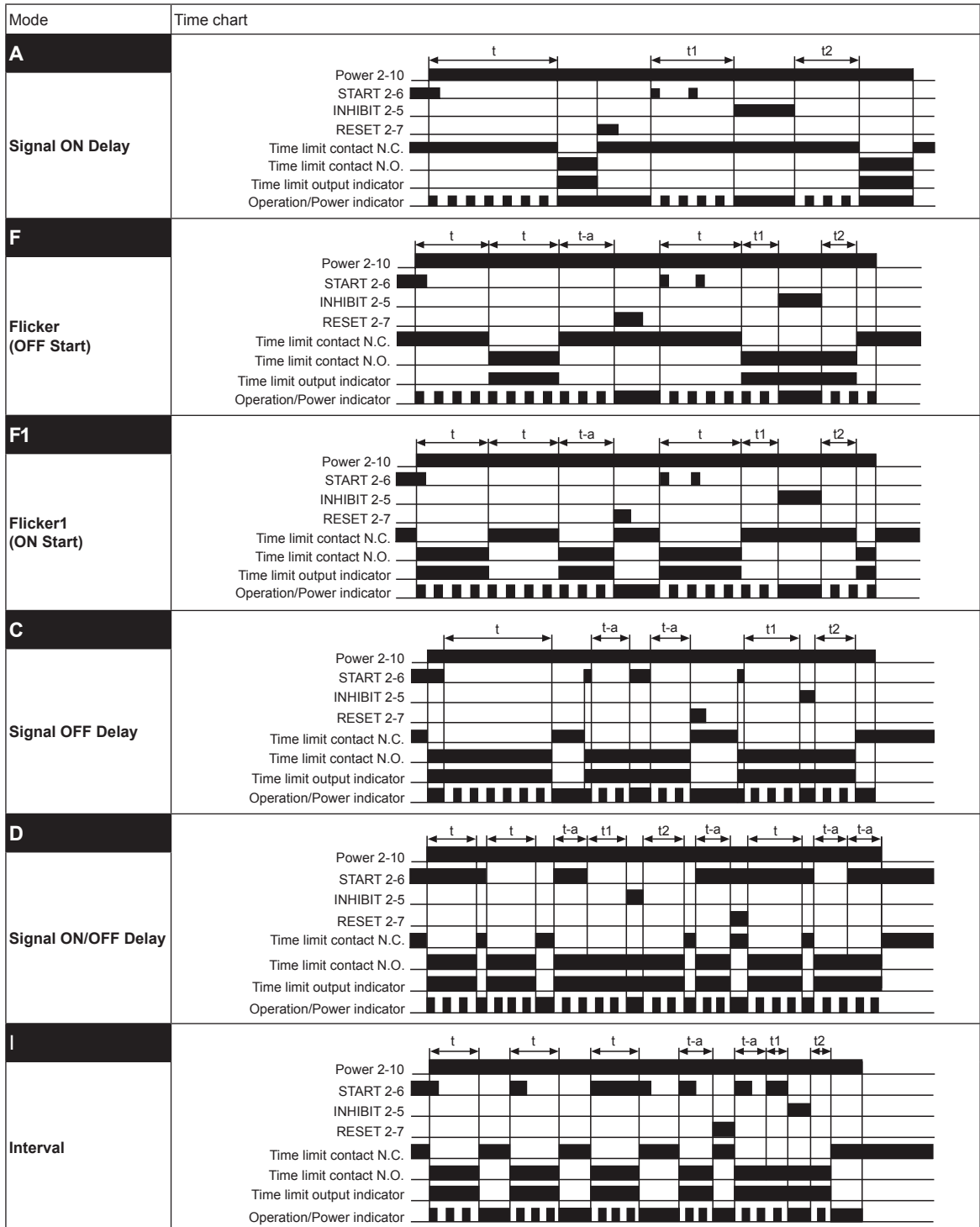

- ※If power is cut or the RESET terminal is short-circuited, the timer will be RESET.
- ※If the INHIBIT terminal is short-circuited during a time limit operation, the time will stop.
- ※In case of F, F1 output operation mode, setting time should be over 100ms.  
If not, it may cause abnormal output operation due to under 100ms of setting time.

# Multi Function Analog Timer

## ■ Proper Usage

- Follow instructions in 'Proper Usage'. Otherwise, it may cause unexpected accidents.
  - 12VDC, 24VDC, 24VAC power supply should be insulated and limited voltage/current or Class 2, SELV power supply device.
  - When supplying or turning off the power, use a switch or etc. to avoid chattering.
  - Install a power switch or circuit breaker in the easily accessible place for supplying or disconnecting the power.
  - In order to avoid leakage current flowing, connect resistance and condenser as (Figure 2).
- If connect as (Figure 1), it may cause malfunction due to leakage current.

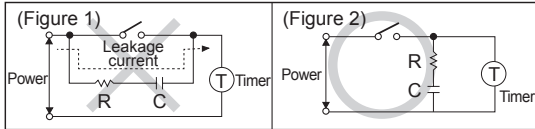

- Keep away from high voltage lines or power lines to prevent inductive noise.  
In case installing power line and input signal line closely, use line filter or varistor at power line and shielded wire at input signal line.  
Do not use near the equipment which generates strong magnetic force or high frequency noise.
- Change setting time, time range, operation mode or etc. after turning off the power of the timer.
- This unit may be used in the following environments.
  - ① Indoors (in the environment condition rated in 'Specifications')
  - ② Altitude max. 2,000m
  - ③ Pollution degree 2
  - ④ Installation category II

(A)	Photoelectric Sensors
(B)	Fiber Optic Sensors
(C)	Door/Area Sensors
(D)	Proximity Sensors
(E)	Pressure Sensors
(F)	Rotary Encoders
(G)	Connectors/ Connector Cables/ Sensor Distribution Boxes/Sockets
(H)	Temperature Controllers
(I)	SSRs / Power Controllers
(J)	Counters
(K)	Timers
(L)	Panel Meters
(M)	Tacho / Speed / Pulse Meters
(N)	Display Units
(O)	Sensor Controllers
(P)	Switching Mode Power Supplies
(Q)	Stepper Motors & Drivers & Controllers
(R)	Graphic/ Logic Panels
(S)	Field Network Devices
(T)	Software