

# Autonics 5-CH TEMPERATURE INDICATOR T4WM SERIES

## INSTRUCTION MAUAL



Thank you for choosing our Autonics product.  
Please read the following safety considerations before use.

### ■ Safety Considerations

- ※Please observe all safety considerations for safe and proper product operation to avoid hazards.
- ※Safety considerations are categorized as follows.
- Warning** Failure to follow these instructions may result in serious injury or death.
- Caution** Failure to follow these instructions may result in personal injury or product damage.
- ※The symbols used on the product and instruction manual represent the following
- ▲ symbol represents caution due to special circumstances in which hazards may occur.

### ▲ Warning

- Fail-safe device must be installed when using the unit with machinery that may cause serious injury or substantial economic loss.** (e.g. nuclear power control, medical equipment, ships, vehicles, railways, aircraft, combustion apparatus, safety equipment, crime/disaster prevention devices, etc.)  
Failure to follow this instruction may result in fire, personal injury, or economic loss.
- Install on a device panel to use.**  
Failure to follow this instruction may result in electric shock or fire.
- Do not connect, repair, or inspect the unit while connected to a power source.**  
Failure to follow this instruction may result in electric shock or fire.
- Check 'Connections' before wiring.**  
Failure to follow this instruction may result in fire.
- Do not disassemble or modify the unit.**  
Failure to follow this instruction may result in electric shock or fire.
- Since Lithium battery is embedded in the product, do not disassemble or burn the unit.**  
Failure to follow this instruction may result in fire.

### ▲ Caution

- When connecting the power input and relay output, use AWG 20(0.50mm<sup>2</sup>) cable or over and tighten the terminal screw with a tightening torque of 1.0N·m. When connecting the sensor input and communication cable without dedicated cable, use AWG 28~16 cable and tighten the terminal screw with a tightening torque of 1.0N·m.**  
Failure to follow this instruction may result in fire or malfunction due to contact failure.
- Use the unit within the rated specifications.**  
Failure to follow this instruction may result in fire or product damage.
- Use dry cloth to clean the unit, and do not use water or organic solvent.**  
Failure to follow this instruction may result in electric shock or fire.
- Do not use the unit in the place where flammable/explosive/corrosive gas, humidity, direct sunlight, radiant heat, vibration, impact, or salinity may be present.**  
Failure to follow this instruction may result in fire or explosion.
- Keep metal chip, dust, and wire residue from flowing into the unit.**  
Failure to follow this instruction may result in fire or product damage.

### ■ Unit Description

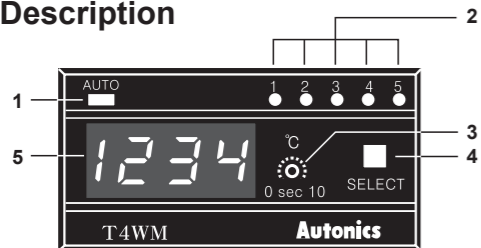

- Channel auto switching indicator**  
LED ON: Auto switching, LED OFF: Manual switching
- Channel indicator (LED ON display)**
- Auto switching time adjuster (1 to 10 sec)**
- Selection switch**  
Auto/Manual channel switching
- Temperature display**

※The above specifications are subject to change and some models may be discontinued without notice.  
※Be sure to follow cautions written in the instruction manual and the technical descriptions (catalog, homepage).

### ■ Ordering information

|      |               |                |                   |                |                    |                |                   |                   |      |                        |
|------|---------------|----------------|-------------------|----------------|--------------------|----------------|-------------------|-------------------|------|------------------------|
| T    | 4             | W              | M                 | -              | N                  | 3              | N                 | P                 | 4    | C                      |
| Item | Size          | Digit          | Input             | Control method | Power supply       | Control output | Sensor input type | Temperature range | Unit | Item                   |
|      | W             | 4              | M                 | N              | 3                  | N              | J                 | 0                 | C    | Temperature Controller |
|      | DIN W96×H48mm | 9999 (4-digit) | 5-Point Indicator | No control     | 110/220VAC 50/60Hz | No output      | J(IC)             | -99.9 to 199.9    | °C   |                        |
|      |               |                |                   |                |                    |                | K(CA)             | 0 to 399          |      |                        |
|      |               |                |                   |                |                    |                | P                 | 0 to 500          |      |                        |
|      |               |                |                   |                |                    |                |                   | 0 to 1200         |      |                        |

※Please check the range of 'Temperature Range For Each Sensor' when select model.

### ■ Specifications

|                         |  |  |
|-------------------------|--|--|
| Series                  | T4WM   |  |
| Power supply            | 110/220VAC~ 50/60Hz  |  |
| Allowable voltage range | 90 to 110% of rated voltage  |  |
| Power consumption       | Max. 3VA   |  |
| Display method          | 7-segment LED method   |  |
| Character size (W×H)    | 9.8×14.2mm   |  |
| Display accuracy        | F.S. ±0.5% rdg ±1-digit  |  |
| Input sensor            | Thermocouples: K(CA), J(IC) / RTD: DPT100Ω                                   |  |
| Input line resistance   | Thermocouples: Max. 100Ω / RTD: Allowable line resistance max. 5Ω per a wire |  |
| Connectable sensors     | 5 (thermocouple, RTD are not used as mixed)                                  |  |
| Channel switch          | Selectable Auto/Manual switching   |  |
| Auto switching time     | Variable 1 to 10 sec (by built-in adjuster)                                  |  |
| Insulation resistance   | Over 100MΩ (at 500VDC megger)  |  |
| Dielectric strength     | 2,000VAC 50/60Hz for 1 min   |  |
| Noise immunity          | ±1kV the square wave noise (pulse width: 1μs) by the noise simulator         |  |
| Vibration               | Mechanical   | 0.75mm amplitude at frequency of 10 to 55Hz (for 1 min) in each X, Y, Z direction for 1 hour |
|                         | Malfunction  | 0.5mm amplitude at frequency of 10 to 55Hz (for 1 min) in each X, Y, Z direction for 10 min  |
| Shock                   | Mechanical   | 300m/s <sup>2</sup> (approx. 30G) in each X, Y, Z direction for 3 times                      |
|                         | Malfunction  | 100m/s <sup>2</sup> (approx. 10G) in each X, Y, Z direction for 3 times                      |
| Environment             | Ambient temperature  | -10 to 50°C, storage:-25 to 65°C   |
|                         | Ambient humidity   | 35 to 85%RH  |
| Unit weight             | Approx. 322g   |  |

※Environment resistance is rated at no freezing or condensation.

### ■ Connection

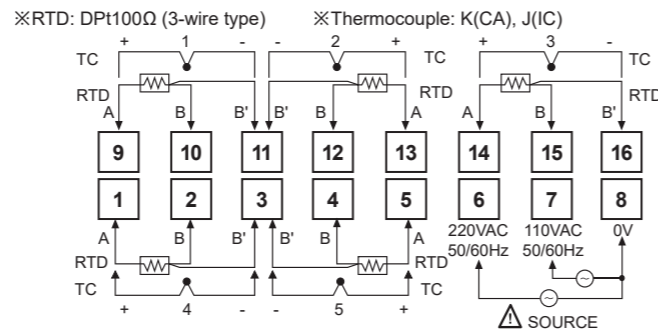

※Use terminals of size specified below.

|   |            |            |
|---|------------|------------|
|   |            |            |
| a | Min. 3.5mm | Min. 3.5mm |
| b | Max. 7.2mm | Max. 7.2mm |

### ■ Temperature Range For Each Sensor

| Model                     | T4WM         |        |                         |
|---------------------------|--------------|--------|-------------------------|
|                           | Thermocouple |        | RTD                     |
| Sensor input type         | J(IC)        | K(CA)  | DPT100Ω                 |
| Standard scale range (°C) | 500°C        | 1200°C | 199.9°C, -99.9°C, 399°C |

### ■ Channel Switching

#### ◎ Auto/Manual channel switching

| Auto switching   | Select witch | Manual switching  |
|--|--------------|---|
| When pressing this for 3 sec and the channel auto switching indicator turns ON and channels switch automatically. (AUTO LED: ON) |              | When press this once, the channel indicator turns ON and channels switch manually (AUTO LED: OFF) |

#### ◎ Auto channel switching

- The temperature of each channel is displayed during auto switching time and switching to the next channel automatically.
- Auto switching time is variable up to 10 sec by the auto switching time adjuster.
- When it is auto channel switching, the channel auto switching indicator turns ON.

#### ◎ Manual channel switching

Whenever touching selection switch (SELECT), channel switches. When a channel indicator turns ON, the temperature of the channel is displayed and whenever touching the switch, it moves to next channel.

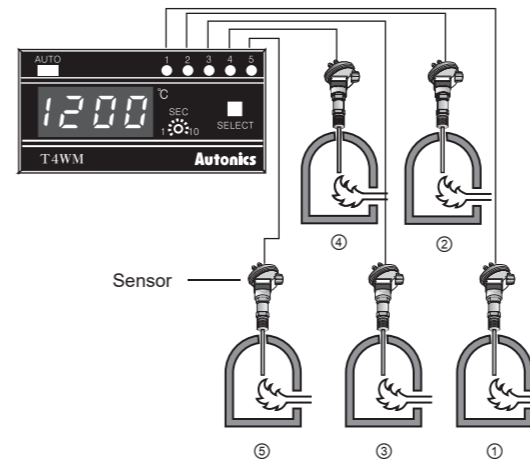

### ■ Memory Protection

When the power fails, the data value will be protected for 3 months. (The battery must be charged fully.)

### ■ Dimensions

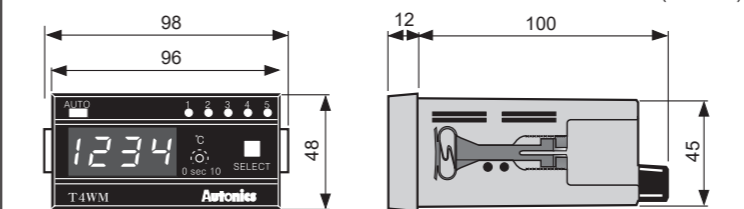

#### ● Panel cut-out

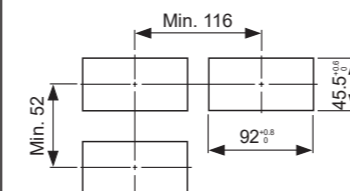

### ■ 5 Point indicator

#### ◎ Mode selection

- How to select the auto mode and manual mode  
: The select switch is ON for 3sec.



- Manual selection : Touch the select switch

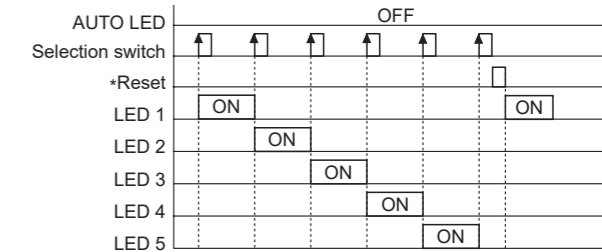

- Auto selection : Display value for each sensor is changed automatically.

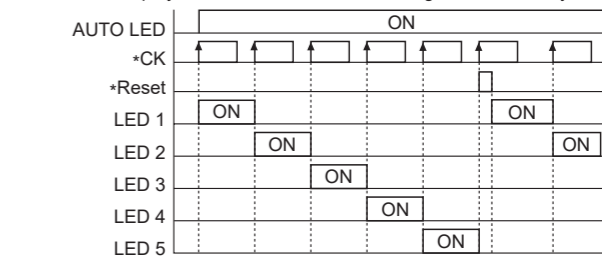

(Note) \*Reset : Automatic reset by DIP switch  
\*CK : Automatic time adjustment

#### ◎ Selection of input sensor by inner DIP switch

Max. 5 different sensors can be connected but cannot use thermocouple and RTD together.

| Sensor Switching | 2            | 3            | 4            | 5            |
|------------------|--------------|--------------|--------------|--------------|
| SW               | ON OFF 3 2 1 | ON OFF 3 2 1 | ON OFF 3 2 1 | ON OFF 3 2 1 |

### ■ Cautions during Use

- Follow instructions in 'Cautions during Use'. Otherwise, It may cause unexpected accidents.
- Check the polarity of the terminals before wiring the temperature sensor.  
For RTD temperature sensor, wire it as 3-wire type, using cables in same thickness and length.  
For thermocouple (TC) temperature sensor, use the designated compensation wire for extending wire.
- Keep away from high voltage lines or power lines to prevent inductive noise.  
In case installing power line and input signal line closely, use line filter or varistor at power line and shielded wire at input signal line.  
Do not use near the equipment which generates strong magnetic force or high frequency noise.
- Install a power switch or circuit breaker in the easily accessible place for supplying or disconnecting the power.
- Do not use the unit for other purpose (e.g. voltmeter, ammeter), but temperature controller.
- Make a required space around the unit for radiation of heat.  
For accurate temperature measurement, warm up the unit over 20 min after turning on the power.
- Make sure that power supply voltage reaches to the rated voltage within 2 sec after supplying power.
- Do not wire to terminals which are not used.
- This unit may be used in the following environments.
  - ①Indoors (in the environment condition rated in 'Specifications')
  - ②Altitude max. 2,000m
  - ③Pollution degree 2
  - ④Installation category II

### ■ Main products

- Photoelectric Sensors
- Fiber Optic Sensors
- Door Sensors
- Door Side Sensors
- Area Sensors
- Proximity Sensors
- Pressure Sensors
- Rotary Encoders
- Connector/sockets
- Switching Mode Power Supplies
- Control Switches/Lamps/Buzzers
- I/O Terminal Blocks & Cables
- Stepper Motors/Drivers/Motion Controllers
- Graphic/Logic Panels
- Field Network Devices
- Laser Marking System (Fiber, Co., Nd: YAG)
- Laser Welding/Cutting System
- Temperature Controllers
- Temperature/Humidity Transducers
- SSRs/Power Controllers
- Counters
- Timers
- Panel Meters
- Tachometer/Pulse (Rate) Meters
- Display Units
- Sensor Controllers

**Autonics Corporation**  
http://www.autonics.com

HEADQUARTERS:  
18, Bansong-ro 513beon-gil, Haeundae-gu, Busan, South Korea, 48002  
TEL: 82-51-519-3232  
E-mail: sales@autonics.com