



LOVATO ELECTRIC S.P.A.

24020 GORLE (BERGAMO) ITALIA
VIA DON E. MAZZA, 12
TEL.: 035 4282111
TELEFAX (Nazionale): 035 4282200
TELEFAX (Intern.): +39 035 4282400
Web www.lovatoelectric.com
E-mail lovato.s@lovatoelectric.com

1225 GB 03 07

TOSHIBA

E6581386

Safety precautions **I**

Introduction **II**

Contents

Read first **1**

Connection equipment **2**

Operations **3**

Searching and setting parameters **4**

Basic parameters **5**

Extended parameters **6**

Operation with external signal **7**

Monitoring the operation status **8**

Measures to satisfy the standards **9**

Selection of peripheral devices **10**

Table of parameters **11**

Specifications **12**

Before making a service call **13**

Inspection and maintenance **14**

Warranty **15**

Disposal of the inverter **16**

Instruction Manual

Variable torque inverter TOSVERT™ VF-PS1

200V class 0.4~90kW
400V class 0.75~630kW



NOTICE

1. Make sure that this instruction manual is delivered to the end user of the inverter unit.
2. Read this manual before installing or operating the inverter unit, and store it in a safe place for reference.

I. Safety precautions





The items described in these instructions and on the inverter itself are very important so that you can use the inverter safely prevent injury to yourself and other people around you as well as prevent damage to property in the area. Thoroughly familiarize yourself with the symbols and indications shown below and then continue to read the manual. Make sure that you observe all cautions given.

Explanation of markings

Marking	Meaning of marking
 Danger	Indicates that errors in operation may lead to death or serious injury.
 Caution	Indicates that errors in operation may lead to injury (*1) to people or that these errors may cause damage to physical property. (*2)

(*1) Such things as injury, burns or shock that will not require hospitalization or long periods of outpatient treatment.
 (*2) Physical property damage refers to wide-ranging damage to assets and materials.

Meanings of symbols

Marking	Meaning of marking
	Indicates prohibition (Don't do it). What is prohibited will be described in or near the symbol in either text or picture form.
	Indicates something mandatory (must be done). What is mandatory will be described in or near the symbol in either text or picture form.
	Indicates danger. What is dangerous will be described in or near the symbol in either text or picture form.
	Indicates caution. What the caution should be applied to will be described in or near the symbol in either text or picture form.

■ Limits in purpose





This inverter is used for controlling speeds of three-phase induction motors in general industrial use.



 **Safety precautions**

- ▼ The inverter cannot be used in any device that would present danger to the human body or which a malfunction or error in operation would present a direct threat to human life (nuclear power control device, aviation and space flight control device, traffic device, life support or operation system, safety device, etc.). If the inverter is to be used for any special purpose, first get in touch with the supplier.
- ▼ When using inverters for critical equipment, even though the inverters are manufactured under strict quality control always fit your equipment with safety devices to prevent serious accident or loss should the inverter fail (such as failure to issue an inverter trouble signal)
- ▼ Do not use the inverter for loads other than those of properly applied three-phase induction motors in general industrial use.
 (Use in other than properly applied three-phase induction motors may cause an accident.)
 When the inverter is used to control the operation of a permanent magnet motor, a combination test must be conducted in advance. For details on the test, contact your supplier.









General Operation

 Danger		Reference
 Disassembly prohibited	<ul style="list-style-type: none"> Never disassemble, modify or repair. This can result in electric shock, fire and injury. For repairs, call your sales agency. 	2.
 Prohibited	<ul style="list-style-type: none"> Never remove the front cover when power is on or open door if enclosed in a cabinet. The unit contains many high voltage parts and contact with them will result in electric shock. Don't stick your fingers into openings such as cable wiring hole and cooling fan covers. This can result in electric shock or other injury. Don't place or insert any kind of object into the inverter (electrical wire cuttings, rods, wires). This can result in electric shock or fire. Do not allow water or any other fluid to come in contact with the inverter. This can result in electric shock or fire. 	2. 2. 2. 2.
 Mandatory	<ul style="list-style-type: none"> Turn power on only after attaching the front cover or closing door if enclosed in a cabinet. If power is turned on without the front cover attached or closing door if enclosed in a cabinet, this can result in electric shock or other injury. If the inverter begins to emit smoke or an unusual odor, or unusual sounds, immediately turn power off. If the equipment is continued to operate in such a state, the result may be fire. Call your local sales agency for repairs. Always turn power off if the inverter is not used for long periods of time since there is a possibility of malfunction caused by leaks, dust and other material. The leakage current caused by the contamination may result in fire. 	2. 3. 3. 3.

 Caution		Reference
 Prohibited contact	<ul style="list-style-type: none"> Do not touch any radiating fins or radiating resistors. They can become very hot, and you may get burned if you touch them. 	3.





■ Transportation & installation



 Danger		Reference
 Prohibited	<ul style="list-style-type: none"> Do not install or operate the inverter if it is damaged or any component is missing. This can result in electric shock or fire. Please consult your local sales agency for repairs. Do not place any inflammable objects nearby. If a flame is emitted due to malfunction, it may result in a fire. Do not install in any location where the inverter could come into contact with water or other fluids. This can result in electric shock or fire. 	<p>2.</p> <p>1.4.4</p> <p>2.</p>
 Mandatory	<ul style="list-style-type: none"> Must be used in the environmental conditions prescribed in the instruction manual. Use under any other conditions may result in malfunction. Must be installed in non-inflammables such as metals. The rear panel gets very hot. If installation is in an inflammable object, this can result in fire. Do not operate with the front panel cover removed. Doing so could result in electric shock. An emergency stop device must be installed that fits with system specifications (e.g. shut off input power then engage mechanical brake). Operation cannot be stopped immediately by the inverter alone, thus risking an accident or injury. All options used must be those specified by Toshiba. The use of any other option may result in an accident. 	<p>1.4.4</p> <p>1.4.4</p> <p>1.4.4</p> <p>10.</p> <p>1.4.4</p> <p>1.4.4</p>



 Caution		Reference
 Prohibited	<ul style="list-style-type: none"> When operating, do not hold by the front panel covers. The covers may come off and the unit will drop out resulting in injury. Do not install in any area where the unit would be subject to large amounts of vibration. That could result in the unit falling, resulting in injury. 	<p>2.</p> <p>1.4.4</p>
 Mandatory	<ul style="list-style-type: none"> Models (20kg or more in weight) designed for 200V-18.5kW or larger and 400V-22kW or larger should be carried by 2 people more, or it could fall and cause an injury. Handle large capacity models using a crane. Lifting heavy inverters can cause injury to persons. Taking care of safety for users, handle carefully in order not to damage the inverter. Carefully lift up the inverter, hanging wires on the hanging bolts or holes on the top or bottom of the inverter. <div style="text-align: center;">  <p>45° max.</p> </div> <p>Note 1: Always keep the two sling ropes in balance when lifting the inverter, and take care that unexpected force does not apply to the inverter during lifting.</p> <p>Note 2: Always protect the inverter with a cover when transporting it.</p> <p>Note 3: Do not put your hand in the wiring port or do not hold it when transporting the inverter.</p> <ul style="list-style-type: none"> The main unit must be installed on a base that can bear the unit's weight. If the unit is installed on a base that cannot withstand that weight, the unit may fall resulting in injury. Install a mechanical brake whenever the motor requires a brake (device which retains the motor shaft). Failure to do so could lead to injury to persons because the inverter itself has no function of mechanically retaining the brake shaft. 	<p>2.</p> <p>1.4.4</p> <p>1.4.4</p>



Wiring



 Danger		Reference
 Prohibited	<ul style="list-style-type: none"> Do not connect input power to the output (motor side) terminals (U/T1,V/T2,W/T3). That will destroy the inverter and may result in fire. Do not connect resistors to the DC terminals (between PA/+ and PC/-, or between PO and PC/-). That may cause a fire. Connect resistors as directed by the instructions for "Installing separate braking resistors." Within 15 minutes after turning off input power, do not touch wires of devices (MCCB) connected to the input side of the inverter. That could result in electric shock. 	<p>2.2</p> <p>2.2 5.19</p> <p>2.2</p>
 Mandatory	<ul style="list-style-type: none"> Electrical construction work must be done by a qualified expert. Connection of input power by someone who does not have that expert knowledge may result in fire or electric shock. Connect output terminals (motor side) correctly. If the phase sequence is incorrect, the motor will operate in reverse and that may result in injury. Wiring must be done after installation. If wiring is done prior to installation that may result in injury or electric shock. The following steps must be performed before wiring. <ol style="list-style-type: none"> Turn off all input power to the inverter. Wait at least 15 minutes and check to make sure that the charge lamp is no longer lit. Use a tester that can measure DC voltage 800VDC or more, and check to make sure that the voltage to the DC main circuits (between PA/+ and PC/-) is 45V or less. If these steps are not properly performed, the wiring will cause electric shock. Tighten the screws on the terminal board to specified torque. If the screws are not tightened to the specified torque, it may lead to fire. Check to make sure that the input power voltage is +10%, -15% of the rated power voltage written on the rating label ($\pm 10\%$ when the load is 100% in continuous operation). If the input power voltage is not +10%, -15% of the rated power voltage ($\pm 10\%$ when the load is 100% in continuous operation) this may result in fire. 	<p>2.</p> <p>2.</p> <p>2.</p> <p>2.</p> <p>2.</p> <p>1.4,4</p>
 Be Grounded	<ul style="list-style-type: none"> Ground must be connected securely. If the ground is not securely connected, it could lead to electric shock or fire when a malfunction or current leak occurs. 	<p>2.</p> <p>2.2</p> <p>10.</p>



 Caution		Reference
 Prohibited	<ul style="list-style-type: none"> Do not attach equipment (such as noise filters or surge absorbers) that have built-in capacitors to the output (motor side) terminals. That could result in a fire. 	<p>2.1</p>

	Caution		Charged capacitors can present a shock hazard even after source power is removed
<p>Drives with EMC filters will retain a charge on the input terminals for up to 15 min. after the power has been removed. To avoid electrical shock, don't touch the connector terminals and uninsulated source cables at either the main circuit disconnect or the drive until the capacitive charge has dissipated.</p>			





Operations



 Danger		Reference
 Prohibited	<ul style="list-style-type: none"> Do not touch inverter terminals when electrical power is applied to the inverter even if the motor is stopped. Touching the inverter terminals while power is connected to it may result in electric shock. Do not touch switches when hands are wet and do not try to clean the inverter with a damp cloth. Such practices may result in electric shock. Do not go near the motor in alarm-stop status when the retry function is selected. The motor may suddenly restart and that could result in injury. Take measures for safety, e.g. attaching a cover to the motor, against accidents when the motor unexpectedly restarts. 	3. 3. 3.
	<ul style="list-style-type: none"> The inverter is tuned automatically (auto-tuning $F400=2, 3$) when the inverter is started for the first time after setup. During auto-tuning, which takes several seconds, the motor is energized, although it is standing still. Noise may be produced by the motor during auto-tuning, which, however, does not indicate that something is wrong with the inverter or the motor. Do not set the stall prevention level ($F501$) extremely low. If the stall prevention level parameter ($F501$) is set at or below the no-load current of the motor, the stall preventive function will always be active and increase the frequency when it judges that regenerative braking is taking place. Do not set the stall prevention level parameter ($F501$) below 30% under normal use conditions. 	6.19 6.26.1
 Mandatory	<ul style="list-style-type: none"> Do not turn on the power before attaching the front cover. When storing inside the cabinet and using with the front cover removed, always close the cabinet doors first and then turn power on. If the power is turned on with the front cover or the cabinet doors open, it may result in electric shock. Make sure that operation signals are off before resetting the inverter after malfunction. If the inverter is reset before turning off the operating signal, the motor may restart suddenly causing injury. Provide cranes and hoists with sufficient circuit protection such as mechanical braking. Without sufficient circuit protection, the resulting insufficient motor torque during tuning could create a risk of machine stalling/falling. 	3. 10. 3. 6.19

 Caution		Reference
 Mandatory	<ul style="list-style-type: none"> Observe all permissible operating ranges of motors and mechanical equipment. (Refer to the motor's instruction manual) Not observing these ranges may result in injury. 	3.

When sequence for restart after a momentary failure is selected



 Caution		Reference
 Mandatory	<ul style="list-style-type: none"> Stand clear of motors and mechanical equipment. If the motor stops due to a momentary power failure, the equipment will start suddenly when power is restored. This could result in unexpected injury. Attach cautions about sudden restart after a momentary power failure on inverters, motors and equipment for prevention of accidents in advance. 	5.18.1

When retry function is selected



 Caution		Reference
 Mandatory	<ul style="list-style-type: none"> Stand clear of motors and equipment. If the motor and equipment stop when the alarm is given, selection of the retry function will restart them suddenly after the specified time has elapsed and alarm condition has disappeared. This could result in unexpected injury. To prevent accidents, stick caution notices that the inverter has a retry function to the inverter, the motor and the machine. 	6.15.1



Maintenance and inspection

 Danger		Reference
 Prohibited	<ul style="list-style-type: none"> Never replace any part by yourself. This could be a cause of electric shock, fire and bodily injury. To replace parts, call the local sales agency. 	14.2
 Mandatory	<ul style="list-style-type: none"> The equipment must be inspected every day. If the equipment is not inspected and maintained, errors and malfunctions may not be discovered which could lead to accidents. Before inspection, perform the following steps. <ol style="list-style-type: none"> Turn off all input power to the inverter. Wait at least 15 minutes and check to make sure that the charge lamp is no longer lit. Use a tester that can measure DC voltage 800VDC or more, and check to make sure that the voltage to the DC main circuits (between PA/+ and PC/-) is 45V or less. If inspection is performed without performing these steps first, it could lead to electric shock. 	14. 14. 14.2

Disposal

 Caution		Reference
 Mandatory	<ul style="list-style-type: none"> If you throw away the inverter, have it done by a specialist in industry waste disposal*. If you throw away the inverter by yourself, this can result in explosion of capacitor or produce noxious gases, resulting in injury. (* Persons who specialize in the processing of waste and known as "industrial waste product collectors and transporters" or "industrial waste disposal persons." If the collection, transport and disposal of industrial waste is done by someone who is not licensed for that job, it is a punishable violation of the law. (Laws in regard to cleaning and processing of waste materials) 	16.

Attach caution labels

Shown here are examples of caution labels to prevent, in advance, accidents in relation to inverters, motors and other equipment.

If the inverter has been programmed for auto-restart function after momentary power failure or retry function, place caution labels in a place where they can be easily seen and read.

If the inverter has been programmed for restart sequence of momentary power failure, place caution labels in a place where they can be easily seen and read.
(Example of caution label)

 **Caution**
(Functions programmed for restart)

Do not go near motors and equipment. Motors and equipment that have stopped temporarily after momentary power failure will restart suddenly after recovery.

If the retry function has been selected, place caution labels in a location where they can be easily seen and read.
(Example of caution label)

 **Caution**
(Functions programmed for retry)

Do not go near motors and equipment. Motors and equipment that have stopped temporarily after an alarm will restart suddenly after the specified time has elapsed and alarm condition has disappeared.

II. Introduction

Thank you for your purchase of the Toshiba "TOSVERT VF-PS1" industrial inverter.

II

- Contents -

I. Safety precautions	1
I.1. Introduction	7
1. Read first	A-1
1.1 Check the product	A-1
1.2 Contents of the product code	A-1
1.3 Structure of the main body	A-2
1.3.1 Names and functions	A-2
1.3.2 Detaching the cover	A-9
1.3.3 Grounding capacitor switching method	A-12
1.3.4 Installing the DC reactor	A-15
1.4 Notes on the application	A-16
1.4.1 Motors	A-16
1.4.2 Inverters	A-18
1.4.3 What to do about the leak current	A-19
1.4.4 Installation	A-21
2. Connection equipment	B-1
2.1 Cautions on wiring	B-1
2.2 Standard connections	B-3
2.3 Description of terminals	B-10
2.3.1 Main circuit terminals	B-10
2.3.2 Control circuit terminal block	B-11
2.3.3 Serial RS485 communication connector	B-16
3. Operations	C-1
3.1 Setting/monitor modes	C-2
3.2 Simplified operation of the VF-PS1	C-3
3.2.1 Terminal board operation	C-3
3.2.2 Panel operation	C-7
4. Searching and setting parameters	D-1
4.1 How to set parameters	D-2
4.1.1 Setting parameters in the selected quick mode	D-2
4.1.2 Setting parameters in the standard setting mode	D-3
4.2 Functions useful in searching for a parameter or changing a parameter setting	D-4
5. Basic parameters	E-1
5.1 History function	E-1
5.2 Setting acceleration/deceleration time	E-2
5.2.1 Automatic acceleration/deceleration	E-2
5.2.2 Manually setting acceleration/deceleration time	E-3
5.3 Increasing starting torque	E-3
5.4 Setting parameters by operating method	E-5
5.5 Selection of operation mode	E-6
5.6 Selecting control mode	E-11
5.7 Manual torque boost—increasing torque boost at low speeds	E-16
5.8 Base frequency	E-16
5.9 Maximum frequency	E-17
5.10 Upper limit and lower limit frequencies	E-17
5.11 Setting frequency command characteristics	E-18
5.12 Preset speed operation (speeds in 15 steps)	E-18
5.13 Selecting forward and reverse runs (operation panel only)	E-20
5.14 Setting the electronic thermal	E-21
5.15 Changing the display unit % to A (ampere)/V (volt)	E-25
5.16 Meter setting and adjustment	E-26

5.17	PWM carrier frequency	E-30
5.18	Trip-less intensification	E-31
5.18.1	Auto-restart (Restart during coasting)	E-31
5.18.2	Regenerative power ride-through control/Deceleration stop during power failure	E-33
5.19	Dynamic (regenerative) braking - For abrupt motor stop	E-34
5.20	Standard default setting	E-40
5.21	Searching for all reset parameters and changing their settings	E-42
5.22	EASY key function	E-43
6.	Extended parameters	F-1
6.1	Input/output parameters	F-1
6.1.1	Low-speed signal	F-1
6.1.2	Putting out signals of arbitrary frequencies	F-2
6.2	Input signal selection	F-3
6.2.1	Priority when forward/reverse run commands are entered simultaneously	F-3
6.2.2	Assigning priority to the terminal board in the operation panel and operation mode	F-4
6.2.3	Analog input signal switching	F-5
6.3	Terminal function selection	F-6
6.3.1	Keeping an input terminal function always active (ON)	F-6
6.3.2	Modifying input terminal functions	F-6
6.3.3	Modifying output terminal functions	F-8
6.4	Basic parameters 2	F-8
6.4.1	Switching among V/f characteristics 1 and 2 from input terminal	F-8
6.5	V/f 5-point setting	F-10
6.6	Speed command switching	F-10
6.6.1	Using two types of frequency (speed) commands	F-10
6.7	Operation frequency	F-12
6.7.1	Start frequency/Stop frequency	F-12
6.7.2	Run/Stop control with frequency setting signals	F-12
6.7.3	Frequency setting signal 0Hz dead zone handling function	F-13
6.8	DC braking	F-13
6.8.1	DC braking	F-13
6.8.2	Motor shaft fixing control	F-15
6.8.3	Function of issuing a 0Hz command during a halt	F-16
6.9	Auto-stop in case of lower-limit frequency continuous operation (Sleep/Wake-up function)	F-17
6.10	Jog run mode	F-18
6.11	Setting frequency via external contact input (Up/Down frequency setting)	F-19
6.12	Jump frequency - jumping resonant frequencies	F-21
6.13	Preset speed operation frequencies	F-22
6.13.1	Preset speed operation frequency 8 to 15	F-22
6.13.2	Forced operation control	F-22
6.14	Bumpless operation	F-23
6.15	Trip-less intensification	F-24
6.15.1	Retry function	F-24
6.15.2	Avoiding overvoltage tripping	F-25
6.15.3	Output voltage adjustment/Supply voltage correction	F-25
6.15.4	Reverse run prohibition	F-27
6.16	Drooping control	F-27
6.17	Commercial power/inverter switching	F-29
6.18	PID control	F-31
6.19	Setting motor constants	F-35
6.20	Increasing the motor output torque further in low speed range	F-39
6.21	Torque limit	F-40
6.22	Speed control gain	F-42
6.23	Fine adjustment of frequency setting signal	F-42
6.24	Operating a synchronous motor	F-43
6.25	Acceleration/deceleration 2	F-43
6.25.1	Setting acceleration/deceleration patterns and switching acceleration/deceleration patterns 1 and 2	F-43

6.26	Protection functions	F-46
6.26.1	Setting of stall prevention level	F-46
6.26.2	Inverter trip record retention	F-46
6.26.3	Emergency stop	F-47
6.26.4	Output phase failure detection	F-48
6.26.5	OL reduction starting frequency	F-48
6.26.6	Input phase failure detections	F-48
6.26.7	Control mode for low current	F-49
6.26.8	Detection of output short circuit	F-50
6.26.9	Overtorque trip	F-50
6.26.10	Cooling fan control selection	F-51
6.26.11	Cumulative operation time alarm setting	F-51
6.26.12	Abnormal speed detection	F-52
6.26.13	Overvoltage limit operation	F-52
6.26.14	Undervoltage trip	F-52
6.26.15	VI/II analog input wire breakage detection level	F-53
6.26.16	Guide to time of replacement	F-53
6.26.17	Rush current suppression relay activation time	F-54
6.26.18	Motor thermal protection	F-54
6.26.19	Braking resistance overload curve	F-54
6.26.20	Selection of a restart condition for the motor stopped with a mechanical brake	F-55
6.26.21	Motor PTC thermal protection	F-56
6.26.22	Protection against a failure of the control power backup device (optional CPS002Z)	F-56
6.27	Forced fire-speed control function	F-58
6.28	Low torque detection signals	F-59
6.29	Override	F-60
6.30	Adjustment parameters	F-62
6.30.1	Pulse train output for meters	F-62
6.30.2	Setting of optional meter outputs	F-63
6.30.3	Calibration of analog outputs	F-63
6.31	Operation panel parameter	F-64
6.31.1	Prohibition of key operations and parameter settings	F-64
6.31.2	Displaying the rotational speed of the motor or the line speed	F-65
6.31.3	Changing the steps in which the value displayed changes	F-66
6.31.4	Changing the standard monitor display	F-67
6.31.5	Selection of operation panel stop pattern	F-67
6.32	Tracing functions	F-67
6.33	Integrating wattmeter	F-70
6.34	Communication function	F-71
6.34.1	2-wire RS485/4-wire RS485	F-71
6.34.2	Open network option	F-77
6.35	My function	F-77
6.36	Instruction manuals for optionally available devices and special functions	F-78
7.	Operation with external signal	G-1
7.1	External operation	G-1
7.2	Applied operation with input and output signals (operation by terminal board)	G-2
7.2.1	Functions of input terminals (in case of sink logic)	G-2
7.2.2	Functions of output terminals (in case of sink logic)	G-5
7.2.3	Analog input filter	G-9
7.3	Setup of external speed command (analog signal)	G-10
7.3.1	Setup by analog input signals (RR/S4 terminal)	G-11
7.3.2	Setup by analog input signals (VI/II terminal)	G-12
7.3.3	Setup by analog input signals (RX terminal)	G-13
8.	Monitoring the operation status	H-1
8.1	Screen composition in the status monitor mode	H-1
8.2	Monitoring the status	H-2

8.2.1	Status monitor under normal conditions	H-2
8.2.2	Display of detailed information on a past trip	H-5
8.3	Changing status monitor function	H-6
8.4	Display of trip information	H-8
8.4.1	Trip code display	H-8
8.4.2	Monitor display at tripping	H-10
8.5	Display of alarm, pre-alarm, etc.	H-12
9.	Taking measures to satisfy the CE/UL/CSA standards	I-1
9.1	Measures to satisfy the standards	I-1
9.1.1	EMC directive	I-1
9.1.2	Measures to satisfy the EMC directive	I-2
9.1.3	Low-voltage directive	I-7
9.1.4	Measures to be taken to satisfy the low-voltage directive	I-7
9.2	Measures to be taken to satisfy the UL/CSA standards	I-8
9.2.1	Caution in installing the inverter	I-8
9.2.2	Caution in wiring and rated current	I-8
9.2.3	Caution as to peripheral devices	I-8
9.2.4	Caution as to the protection of motors from overload	I-9
9.3	Compliance with safety standards	I-10
10.	Selection of peripheral devices	J-1
10.1	Selection of wiring materials and devices	J-1
10.2	Installation of a magnetic contactor	J-3
10.3	Installation of an overload relay	J-3
10.4	Application and functions of options	J-4
10.5	Optional internal devices	J-8
10.6	Connection of a DC power supply and other electric units	J-11
10.6.1	Connection of a single-phase 200V power supply	J-11
10.6.2	When using the inverter along with a DC power supply	J-11
11.	Table of parameters	K-1
12.	Specifications	L-1
12.1	Models and their standard specifications	L-1
12.2	Outside dimensions and weight	L-5
13.	Before making a service call- Trip information and remedies	M-1
13.1	Trip causes/warnings and remedies	M-1
13.2	Method of resetting causes of trip	M-6
13.3	If the motor does not run while no trip message is displayed.	M-7
13.4	How to check other troubles	M-8
14.	Inspection and maintenance	N-1
14.1	Regular inspection	N-1
14.2	Periodical inspection	N-2
14.3	Making a call for servicing	N-4
14.4	Keeping the inverter in storage	N-4
15.	Warranty	O-1
16.	Disposal of the inverter	P-1

1. Read first

1.1 Check the product

Before using the product you have purchased, check to make sure that it is exactly what you ordered.

Caution

Mandatory

Use an inverter that conforms to the specifications of the power supply and three-phase induction motor being used. If the inverter being used does not conform to those specifications, not only will the three-phase induction motor not rotate correctly, but it may cause serious accidents through overheating and fire.

Type indication

VF-PS1 3PH-200/240V
3.7kW/5HP

Series name
Power supply
Motor capacity

Carton box

Type indication label

Instruction manual

This manual

Inverter main unit

Type indication
Warning label
Name plate

Warning label

Name plate

TOSHIBA
TRANSISTOR INVERTER

VFPS1-2004PL-WN
0.4kW-1.1kVA-0.5HP

INPUT		OUTPUT	
U/V	3PH 200/240	3PH 200/240	
F(Hz)	50/60	50/60	
I(A)	3.5 max	10 max	

S.Ctkt 5000A FUSE J 10Amax 11.5lb-in/1.3Nm

Serial No. 2510 05021303 0001
Made in *****

Motor Protective Device Class 10

LISTED 170M
IND.CONTEQ.

TOSHIBA CORPORATION
TSUJ

Inverter Type
Applicable motor
Invert rated output capacity
Power supply
Related input current
Related output current
Serial No.

1.2 Contents of the product code

Explanation of the type and form written on the label.

Type		Form					Special specification code											
V	F	P	S	1	2	0	3	7	P	L	Y	-	W	N	-	A	2	2
Model name TOSVERT VF-PS1 series	Voltage class 2: 200V~240V 4: 380V~480V	Applicable motor capacity 004:0.4kW 007:0.75kW 015:1.5kW 022:2.2kW 037:3.7kW 055:5.5kW 075:7.5kW 110:11kW 150:15kW 185:18.5kW 220:22kW 300:30kW 370:37kW		450:45kW 550:55kW 750:75kW 900:90kW 110K:110kW 132K:132kW 160K:160kW 220K:220kW 250K:250kW 280K:280kW 315K:315kW 400K:400kW 500K:500kW 630K:630kW		Operation panel P: Provided	Additional functions I L: Built-in EMC filter basic filter M: Built-in basic filter C: Built-in EMC filter		Additional functions II Y: Others (non-standard)		Special specification code A□□: Special specification code (□□ is a number)		Default interface logic (*1) WN: Negative WP: Positive					

*1): This code represents the factory default logic setting. You can switch from one input/output logic to the other using slide switch SW1. ⇒ For more details, refer to Section 2.3.2.

1.3 Structure of the main body

1.3.1 Names and functions

1) Outside view

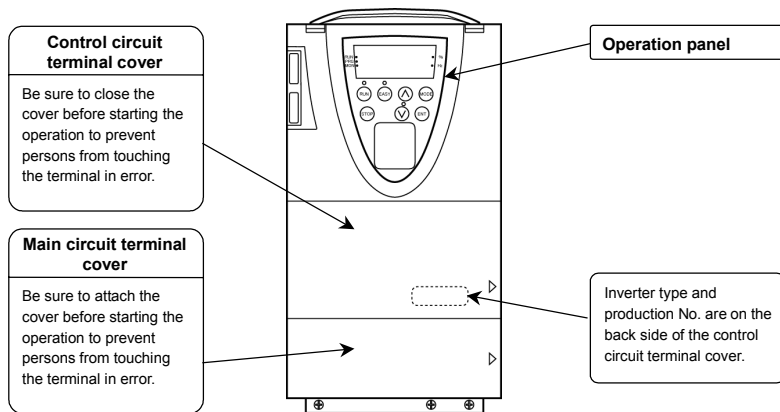

[Front panel]

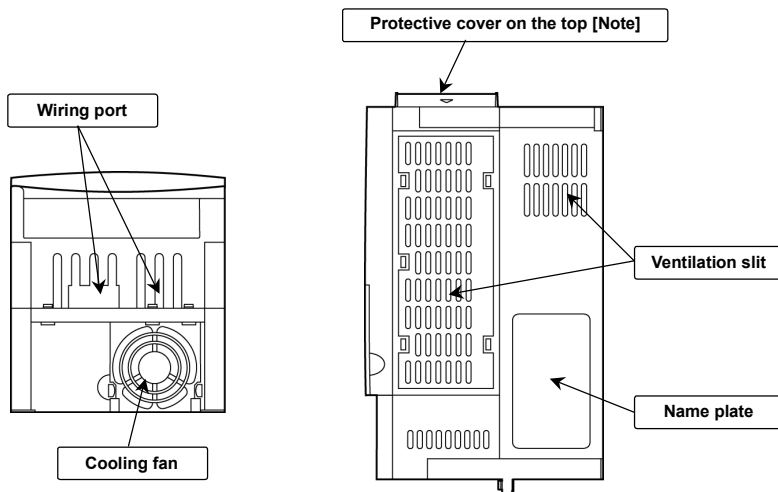

[Bottom view]

[Side view]

Note: Remove this cover when installing the inverter side by side with other inverters where the ambient temperature will rise above 40°C. ⇒ For more details, refer to Section 1.4.4.

■ Operation panel

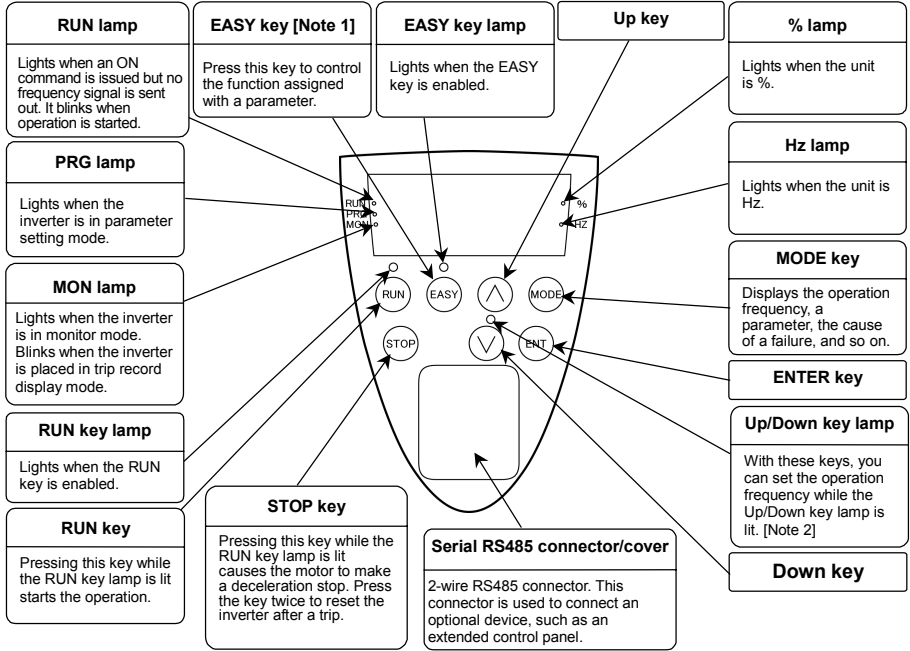

Note 1: ⇒ For details EASY Key functions, refer to Section 5.22.

Note 2: When parameter $F730$ is set to 1 , the operation frequency cannot be set even if this lamp is lit.

2) Main circuit terminal

VFPS1-2004PL~2015PL
VFPS1-4007PL~4022PL

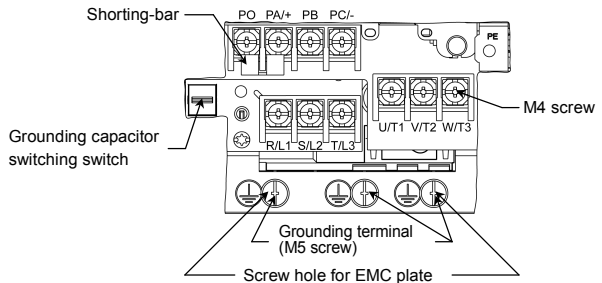

VFPS1-2022PL, 2037PL
VFPS1-4037 PL

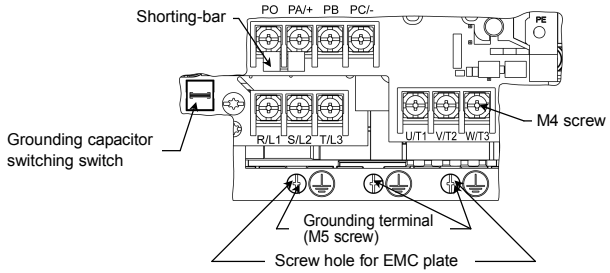

VFPS1-2055PL
VFPS1-4055PL, 4075PL

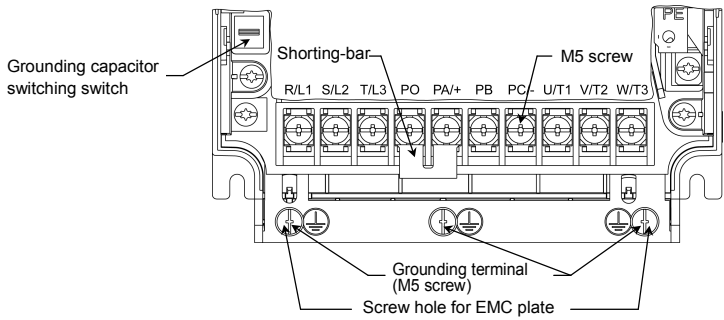

VFPS1-2075PL
VFPS1-4110PL

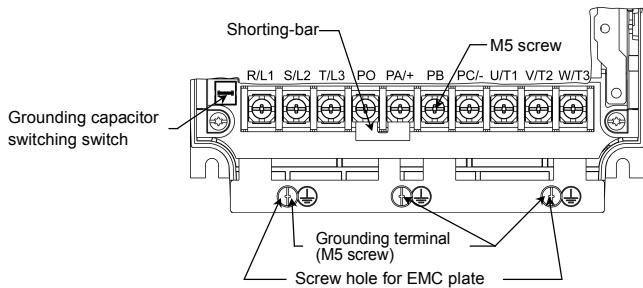

VFPS1-2110PM, 2150PM
VFPS1-4150PL, 4185PL

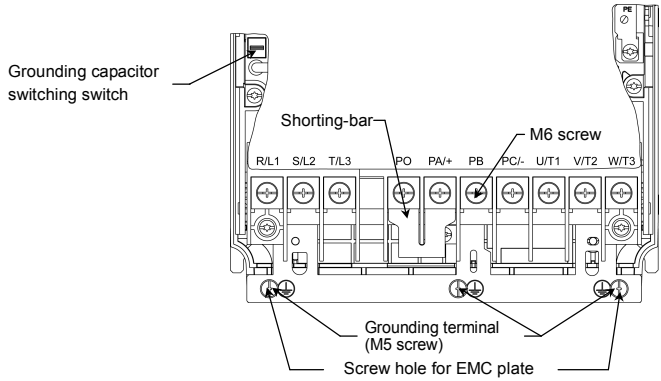

1

VFPS1-2185PM, 2220PM
VFPS1-4220PL

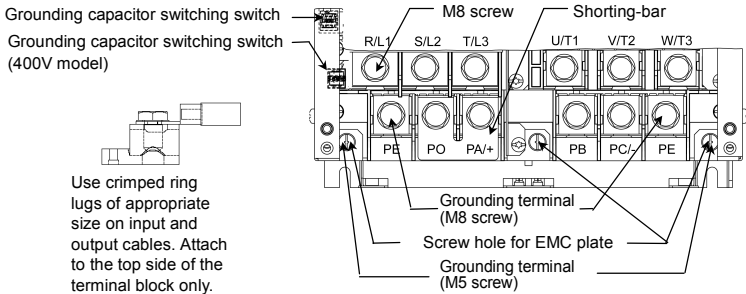

Use crimped ring lugs of appropriate size on input and output cables. Attach to the top side of the terminal block only. **Do not place wires in the hole of the terminal block.**

VFPS1-4300PL, 4370PL

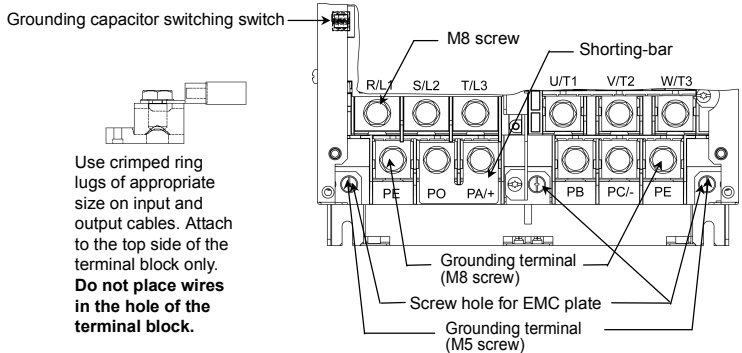

Use crimped ring lugs of appropriate size on input and output cables. Attach to the top side of the terminal block only. **Do not place wires in the hole of the terminal block.**

VFPS1-2300PM~2450PM
VFPS1-4450PL~4750PL

Grounding capacitor switching switch

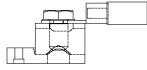

Use crimped ring lugs of appropriate size on input and output cables. Attach to the top side of the terminal block only. **Do not place wires in the hole of the terminal block.**

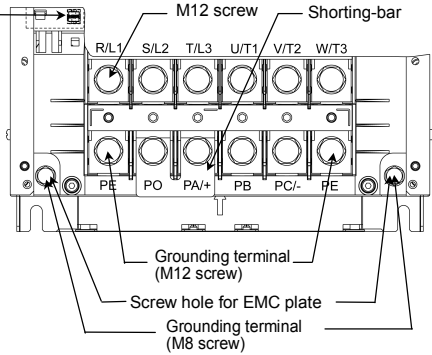

VFPS1-2550P, 2750P
VFPS1-4900PC, 4110KPC

M12 screw

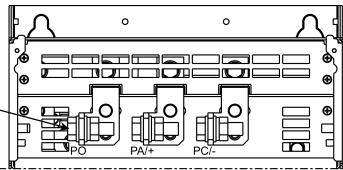

M10 screw

Grounding capacitor switching bar

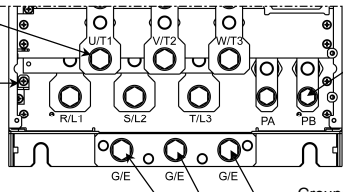

M8 screw

Grounding terminal (M10 screw)

VFPS1-2900P
VFPS1-4132KPC

M12 screw

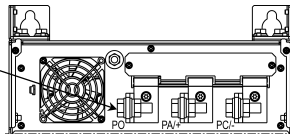

M10 screw

Grounding capacitor switching bar

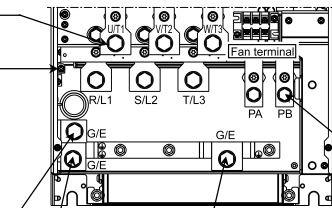

Fan terminal

RO SO TO

M4 screw

M8 screw

Grounding terminal (M10 screw)

VFPS1-4160KPC

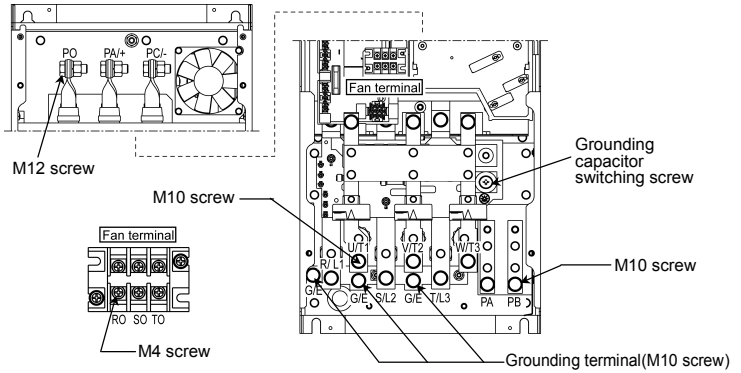

VFPS1-4220KPC

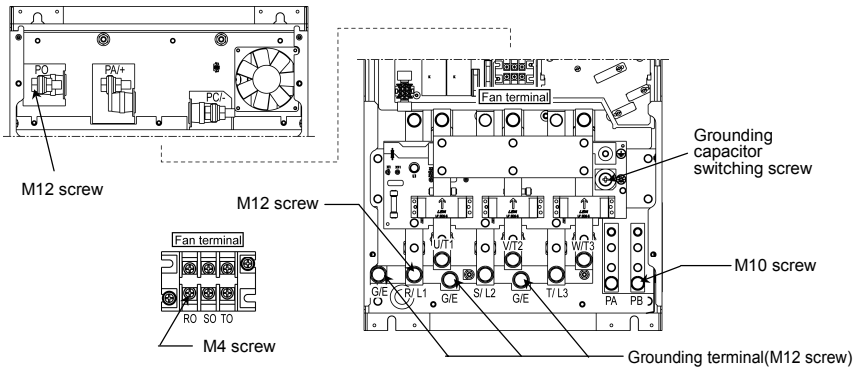

VFPS1-4250KPC~4315KPC

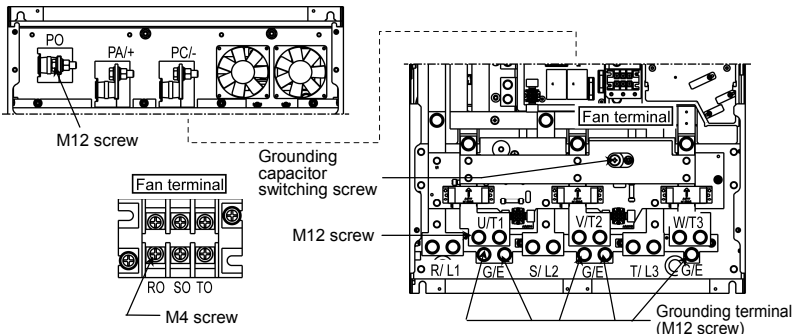

1

VFPS1-4400KPC

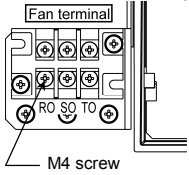

Grounding capacitor switching screw

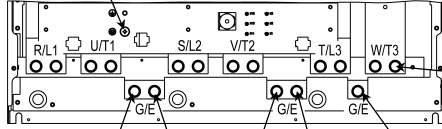
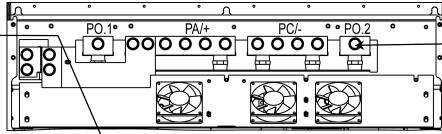

Grounding terminal (M12 screw)

VFPS1-4500KPC

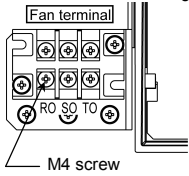

Grounding capacitor switching screw

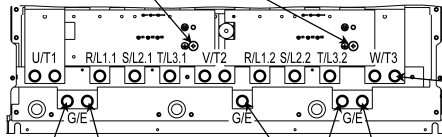
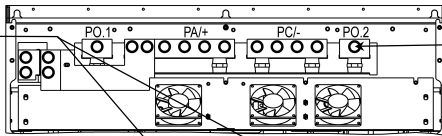

Grounding terminal (M12 screw)

VFPS1-4630KPC

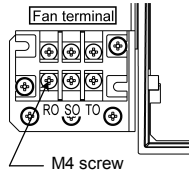

Grounding capacitor switching screw

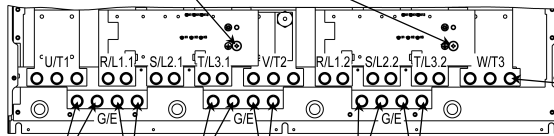
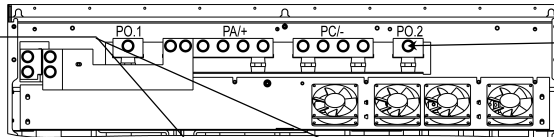

Grounding terminal (M12 screw)

3) Control circuit terminal block

The control circuit terminal block is common to all equipment.

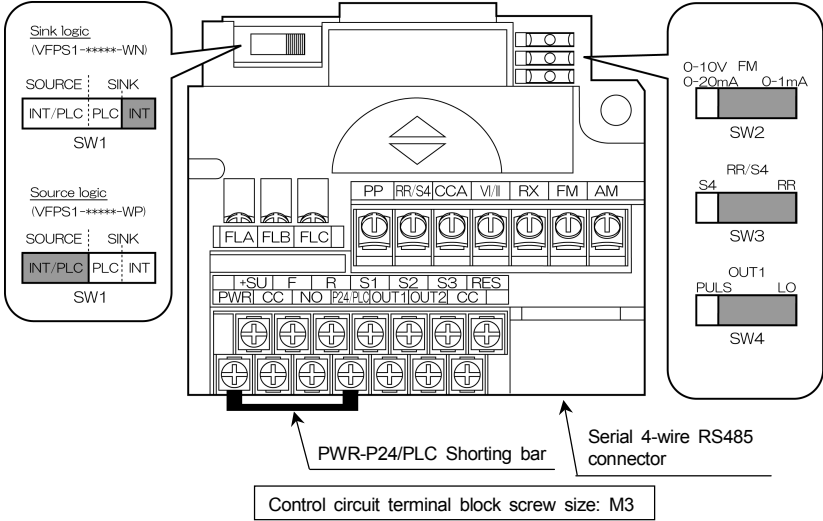

⇒ For details on all terminal functions, refer to Section 2.3.2.

1.3.2 Detaching the cover

■ Main circuit terminal cover

To wire the main circuit terminal for models 200V-15kW or smaller and 400V-18.5kW or smaller, remove the main circuit terminal cover in line with the steps given below.

(A)

(B)

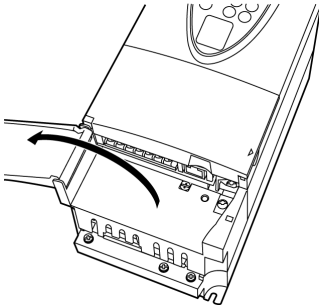

Open the main circuit terminal cover.
 * To open the cover, lift it with your finger placed at the part  on the right side of the cover.

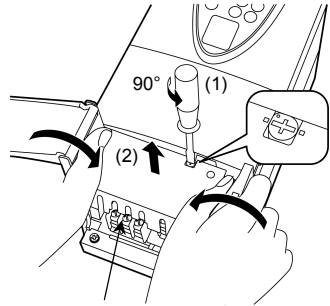

Remove the main circuit terminal cover.
 * Turn the screw securing the cover counterclockwise by 90° to release the lock (do not turn the screw by more than 90°. Or the screw might be broken.), and then hold the cover by both ends and pull the cover up, slightly bending it inward.

For 200V/0.4kW to 200V/15kW models and 400V/0.75kW to 400V/18.5kW models, cut off the tabs (part A in the figure below) on the main circuit terminal cover if necessary for connecting the cables from the power supply.

200V-0.4kW~3.7kW
400V-0.75kW~3.7kW

200V-5.5kW~15kW
400V-5.5kW~18.5kW

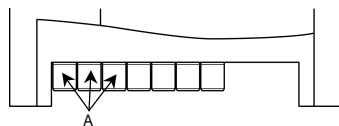
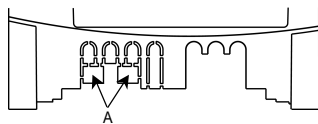

1

■ Front cover

To wire the main circuit terminal for models 200V-18.5kW or more and 400V-22kW or more, remove the front cover.

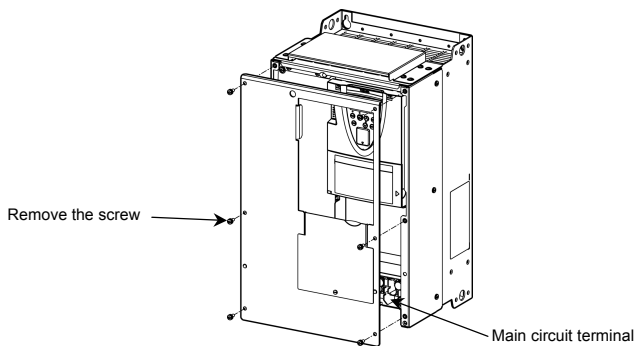

■ Control circuit terminal cover

To wire the control circuit terminal, open the control circuit terminal cover in line with the steps given below.

(A)

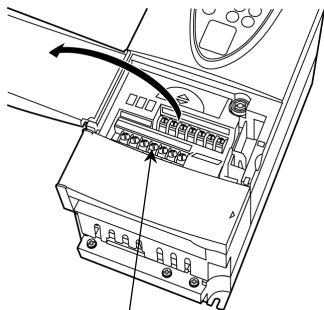

Control circuit terminal

Open the control circuit terminal cover.
* To open the cover, lift it with your finger placed at the ▸ part on the right side of the cover.

(B)

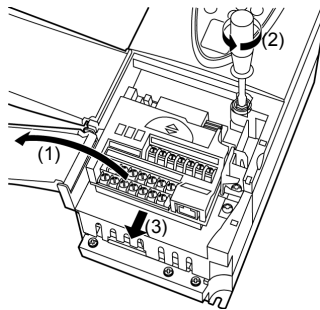

Remove the terminal, if necessary.
* To do so, open the main circuit terminal cover, loosen the screws that fix the terminal, using a (-) screwdriver or torx (T20H) screwdriver, placed your finger on part ◀ and pull out the terminal.

■ Charge lamp

This lamp is lit when a high voltage remains in the inverter. When removing the main circuit terminal cover or opening the front cover, be sure to check that this lamp is off and follow the instructions about wiring on page 4.

The mounting position of the charge lamp varies from model to model.

VFPS1-2004PL~2150PM
VFPS1-4007PL~4185PL

This lamp is placed behind the main circuit terminal cover.

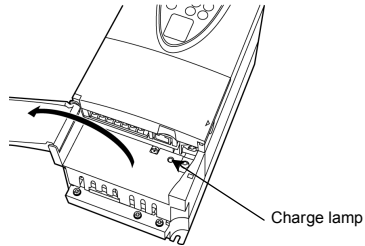

1

VFPS1-2185PM~2450PM
VFPS1-4220PL~4750PL

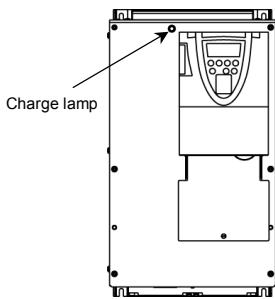

VFPS1-2550P~2900P
VFPS1-4900PC~4630KPC

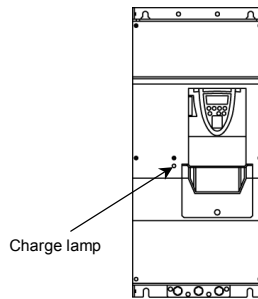

1.3.3 Grounding capacitor switching method



The inverter is grounded through a capacitor. The leakage current from the inverter can be reduced using the selector switch, switching bar or switching screw (depending on the model) on the main circuit terminal board. This switching device is used to detach the capacitor from the grounding circuit or to reduce its capacitance.

Some models have capacitors that can be detached completely, while others have capacitors whose capacitances can be reduced.

Note 1: Please note that, without the capacitor, the inverter does not comply with the EMC directive.

Note 2: When attaching or detaching the capacitor, be sure to turn off power.

■ 200V/45kW - 400V/75kW models and smaller: Grounding capacitor switching switch

 Danger	
 Prohibited	If you are using an inverter with a capacity of 400V-3.7/4.0kW or less or with a capacity between 400V-5.5kW and 400V-18.5kW, if the cables connecting the inverter to the motor is 100 m or more in length, and if the grounding capacitor is detached from the inverter, be sure to set the carrier frequency (f_c) at 4kHz or less. If the carrier frequency is set above 4kHz, internal parts of the inverter may overheat and become damaged.

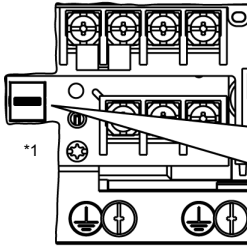

*1: There are two places according to the model.
⇒ For details, refer to Section 1.3.1.

Note: If you are using a 400V-3.7/4.0kW model or less or a model with a capacity between 400V-5.5kW and 400V-18.5kW with it connected to a motor through cables 100m or more in length, you should set the carrier frequency (f_c) at 4kHz or less when pulling up the switch. Be sure to read the above precaution.

200V 0.4kW~7.5kW, 18.5kW, 22kW
400V 0.75kW~18.5kW

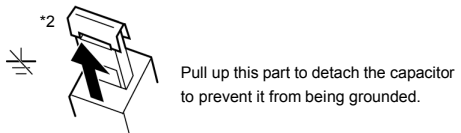
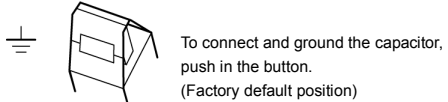

*2: For 400V-3.7/4.0kW model and smaller, the switch is fixed with a label saying "CF/SFr ≤ 4kHz." If such a label is affixed to your inverter, you should set the carrier frequency (f_c) at 4kHz or less according to the instructions when switching.

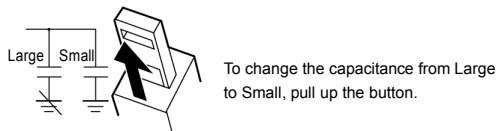
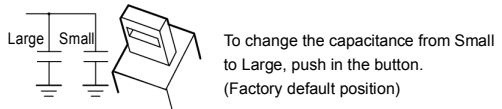

200V 11kW, 15kW, 30kW~45kW
400V 22kW~75kW

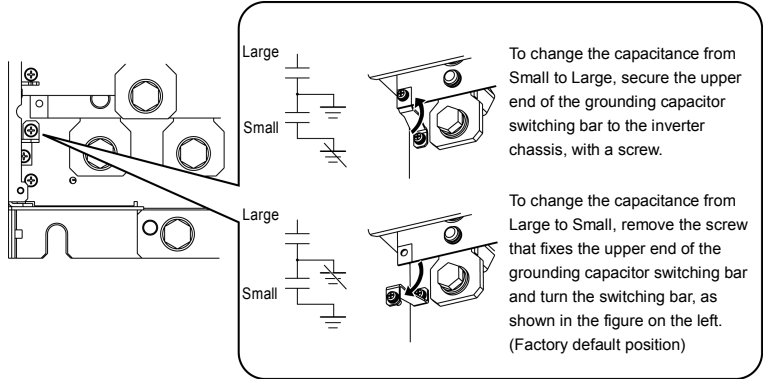

■ 200V/55kW models and larger 400V/90kW~132kW models: Grounding capacitor switching bar





1

 Danger	
	In case of one phase grounding system (A three-phase supply power is connected in delta), do not change the connection of grounding capacitor before factory setting. If connection changed (this means the capacitance is increased), the capacitor may become damaged.

Note: If a neutral grounding system is used, changing the connection of the grounding capacitor as shown in the figure at the top (changing the capacitance from Small to Large) makes the inverter compliant with the EMC directive.

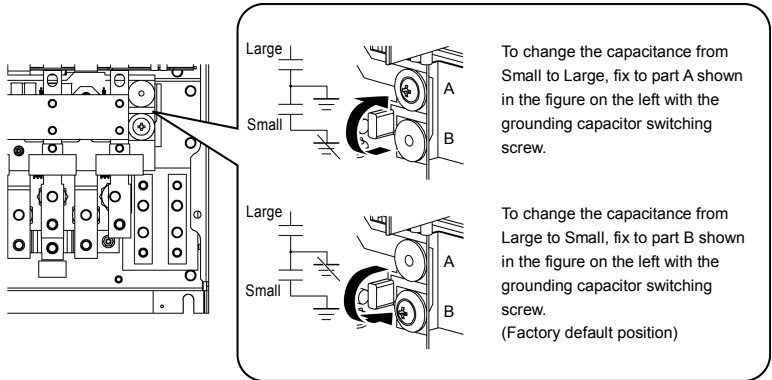
■ 400V/160kW models and larger: Grounding capacitor switching screw
 «160kW, 220kW



 Danger	
	In case of one phase grounding system (A three-phase supply power is connected in delta), do not change the connection of grounding capacitor before factory setting. If connection changed (this means the capacitance is increased), the capacitor may become damaged.

Note: If a neutral grounding system is used, changing the connection of the grounding capacitor as shown in the figure at the top (changing the capacitance from Small to Large) makes the inverter compliant with the EMC directive.

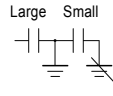
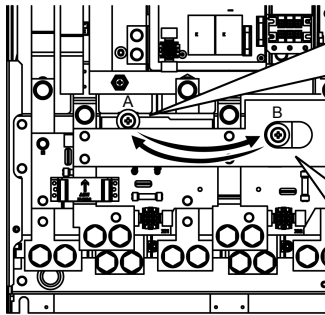

«250kW~315kW»

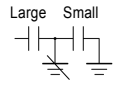

To change the capacitance from Small to Large, fix to part A shown in the figure on the left with the grounding capacitor switching screw.



To change the capacitance from Large to Small, fix to part B shown in the figure on the left with the grounding capacitor switching screw.
(Factory default position)

 Danger	
 Prohibited	In case of one phase grounding system (A three-phase supply power is connected in delta), do not change the connection of grounding capacitor before factory setting. If connection changed (this means the capacitance is increased), the capacitor may become damaged.

Note: If a neutral grounding system is used, changing the connection of the grounding capacitor as shown in the figure at the top (changing the capacitance from Small to Large) makes the inverter compliant with the EMC directive.

«400kW~630kW»

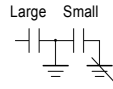
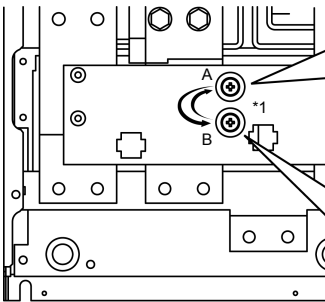

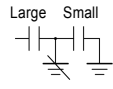

To change the capacitance from Small to Large, fix to part A shown in the figure on the left with the grounding capacitor switching screw.



To change the capacitance from Large to Small, fix to part B shown in the figure on the left with the grounding capacitor switching screw.
(Factory default position)

*1: For 500kW and 630kW models, there are two places.
=> Refer to Section 1.3.1.

 Danger	
 Prohibited	In case of one phase grounding system (A three-phase supply power is connected in delta), do not change the connection of grounding capacitor before factory setting. If connection changed (this means the capacitance is increased), the capacitor may become damaged.

Note: If a neutral grounding system is used, changing the connection of the grounding capacitor as shown in the figure at the top (changing the capacitance from Small to Large) makes the inverter compliant with the EMC directive.

1.3.4 Installing the DC reactor

■ How to install (Example: VFPS1-4220KPC)

(1)

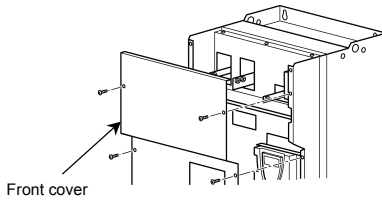

Front cover

Remove the front cover.

(2)

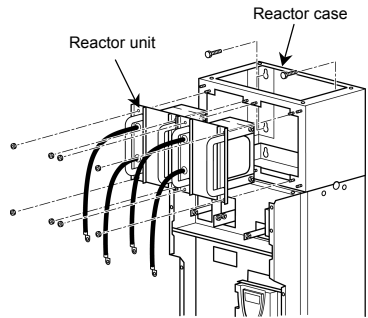

Mount the reactor case on an inner wall of the cabinet and secure the reactor unit to the case with screws.

(3)

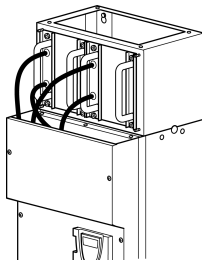

Connect the reactor unit to the PO and PA/+ terminals on the main-circuit terminal board. Then connect the supplied earth wire.
⇒ See the figures on the next page.
Fix the front cover after connection

(4)

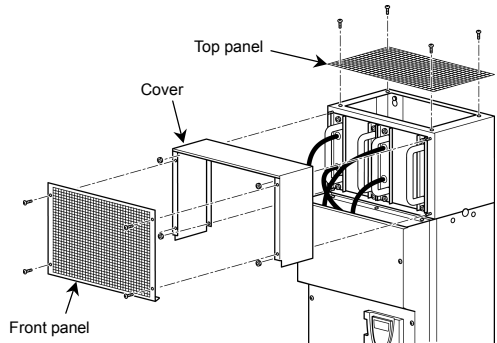

Secure the cover, front panel and top panel to the reactor case with screws.

1

■ Example of wiring of each model

«VFPS1-2550P~2900P, 4900PC~4160KPC»

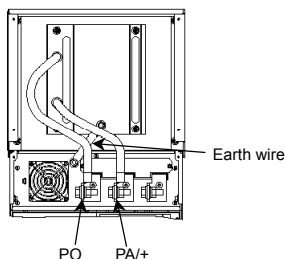

«VFPS1-4220KPC~4315KPC»

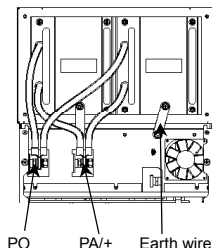

«VFPS1-4400KPC»

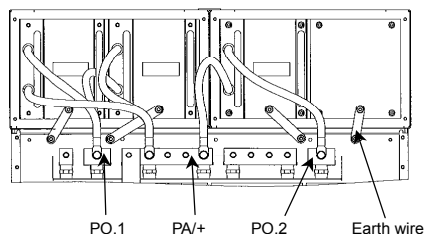

«VFPS1-4500KPC, 4630KPC»

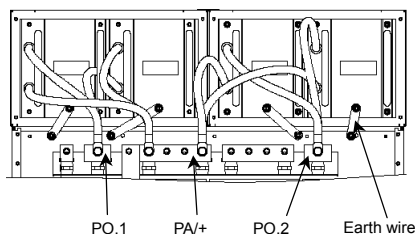

1.4 Notes on the application

1.4.1 Motors

Keep the following in mind when using the VF-PS1 to drive a motor.

⚠ Caution	
! Mandatory	Use an inverter that conforms to the specifications of power supply and three-phase induction motor being used. If the inverter being used does not conform to those specifications, not only will the three-phase induction motor not rotate correctly, but it may cause serious accidents through overheating and fire.

Comparisons with commercial power operation

The VF-PS1 Inverter employs the sinusoidal PWM system to supply the motor. This is why compared to operation with a commercial power there will be a slight increase in motor temperature, noise and vibration. The main supply voltage and current will also be distorted due to harmonic distortion while increase the line current.

Adjusting the overload protection level

The VF-PS1 Inverter protects against overloads with its electronic thermal overload detection circuits. The electronic thermal's reference current of the inverter must be adjusted in line with the rated current of the motor being used in combination.

High-speed operation at and above 50Hz/60Hz (rated frequency)

Operating at frequencies greater than 50Hz/60Hz will increase noise and vibration. There is also a possibility that such operation will exceed the motor's mechanical strength under these conditions and the bearing limits. You should verify with the motor's manufacturer operating.

Method of lubricating load mechanisms

Operating an oil-lubricated reduction gear and gear motor in the low-speed areas will worsen the lubricating effect. Check with the manufacturer to find out about operable speed range.

Low loads and low inertia loads

The motor may demonstrate instability such as abnormal vibrations or overcurrent trips at light loads of 50% or under of the rated load, or when the load's moment of inertia is extremely small. If that happens reduce the carrier frequency.

Occurrence of instability

Unstable phenomena may occur under the load and motor combinations shown below.

- Combined with a motor that exceeds applicable motor ratings recommended for the inverter
- Combined with special motors

To deal with the above lower the settings of inverter carrier frequency. (When performing vector control, set the carrier frequency at 2kHz or more. If the carrier frequency is set below 2kHz, it will be automatically corrected to 2kHz by the inverter.)

- Combined with couplings between load devices and motors with high backlash

In this case, set the S-pattern acceleration/deceleration function and adjust the response time inertial moment setting during vector control or switch to V/f control ($P \xi = \bar{G}$).

- Combined with loads that have sharp fluctuations in rotation such as piston movements

In this case, adjust the response time inertial moment setting during vector control or switch to V/f control ($P \xi = \bar{G}$).

Braking a motor when power supply is lost

A motor with its power cut off goes into freewheel, and does not stop immediately. To stop the motor quickly as soon as the power is cut off install an auxiliary brake. There are different kinds of brake devices, both electrical and mechanical. Select the brake that is best for the system.

Loads that generate negative torque

When combined with loads that generate negative torque the protection for overvoltage and overcurrent on the inverter will go into operation and may cause a trip. For this kind of situation, you must install a dynamic braking resistor, etc. that complies with the load conditions.

Motor with brake

If a brake motor is used with the braking circuit connected to the output terminals of the inverter, the brake cannot be released because of a voltage drop at startup. Therefore, when using the inverter along with a brake motor, connect the braking circuit to the power supply side of the inverter, as shown in the figure below. In most cases, the use of a brake motor causes an increase in noise at low-speed.

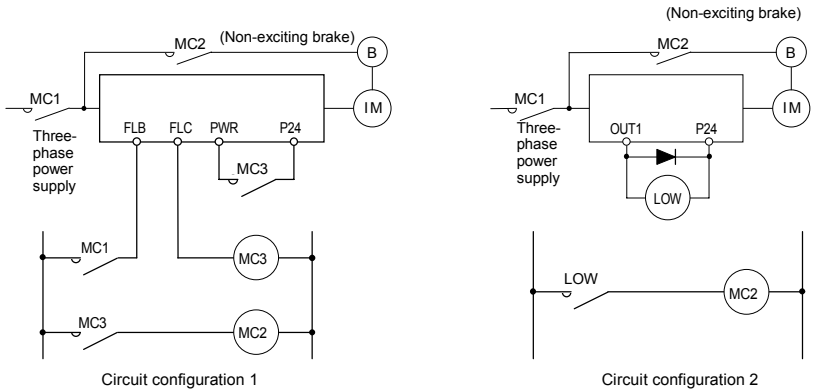

1

In circuit configuration 1, the brake is turned on and off through MC2 and MC3. If the circuit is configured in some other way, the overcurrent trip may be activated because of the locked rotor current when the brake goes into operation.

Circuit configuration 2 uses low-speed signal OUT1 to turn on and off the brake. Turning the brake on and off with a low-speed detection (OUT1 function) may be better in such applications as elevators. Please confer with your supplier before designing the system.

Measures to protect motors against surge voltages

In a system in which a 400V-class inverter is used to control the operation of a motor, very high surge voltages may be produced. When applied to the motor coils repeatedly for a long time this can cause deterioration of their insulation, depending on the wire length, wire routing and types of wires used. Here are some examples of measures against surge voltages.

- (1) Lower the inverter's carrier frequency.
- (2) Set the parameter $F\beta$ (Carrier frequency control mode selection) to 2 or 3.
- (3) Use motors with a high dielectric strength.
- (4) Insert a reactor or a surge voltage suppression filter between the inverter and the motor.

1.4.2 Inverters

Protecting inverters from overcurrent

The inverter has an overcurrent protection function. The programmed current level is set to the inverter's maximum applicable motor. If the motor used has a small capacity, the stall prevention level, overcurrent level and the motor electronic thermal protection must be readjusted. If adjustment is necessary, refer to Section 5.14, and make adjustments as directed.

Inverter capacity

Do not operate a large capacity motor with a small capacity (kVA) inverter even with light loads. Current ripple will raise the output peak current making it easier to set off the overcurrent trip.

Power factor correction capacitor

Power factor correction capacitors cannot be installed on the output side of the inverter. When a motor is run that has a power factor correction capacitor attached to it, remove the capacitors. This can cause inverter malfunction trips and capacitor destruction.

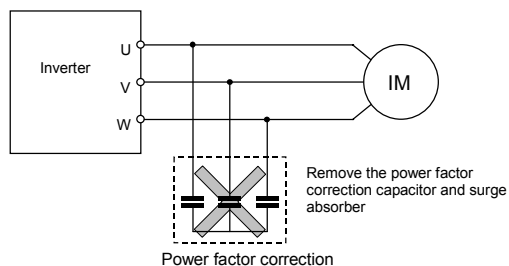

Operating at other than rated voltage

Connections to voltages other than the rated voltage described in the rating label cannot be made. If a connection must be made to a power supply other than one with rated voltage, use a transformer to raise or lower the voltage to the rated voltage.

Circuit interrupting when two or more inverters are used on the same power line.

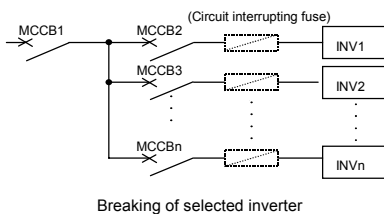

There is no fuse in the inverter's main circuit. Thus, as the diagram above shows, when more than one inverter is used on the same power line, you must select interrupting characteristics so that only the MCCB2 will trip and the MCCB1 will not trip when a short occurs in the inverter (INV1). When you cannot select the proper characteristics install a circuit interrupting fuse between the MCCB2 and the INV1.

If power supply distortion is not negligible

If the power supply distortion is not negligible because the inverter shares a power distribution line with other systems causing distorted waveforms, such as systems with thyristors or large-capacity inverters, install an input reactor to improve the input power factor, to reduce higher harmonics, or to suppress external surges.

■ Disposal

If an inverter is no longer usable, dispose of it as industrial waste.

1

1.4.3 What to do about the leak current

Caution

Current may leak through the inverter's input/output wires because of insufficient electrostatic capacity on the motor with bad effects on peripheral equipment. The leakage current's value is affected by the carrier frequency and the length of the input/output wires. Test and adopt the following remedies against leakage current.

(1) Effects of leakage current across ground

Leakage current may flow not just through the inverter system but also through ground wires to other systems. Leakage current will cause earth leakage current breakers, leakage current relays, ground relays, fire alarms and sensors to operate improperly, and it will cause superimposed noise on the CRT screen or display of incorrect current values during current detection with the CRT.

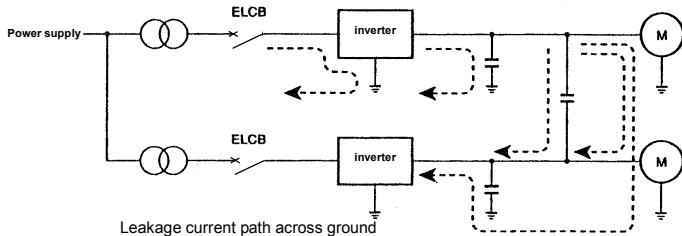

Remedies:

1. Reduce PWM carrier frequency.
The setting of PWM carrier frequency is done with the parameter ζF .
2. If there is no radio-frequency interference or similar problem, detach the built-in noise filter capacitor.
⇒ Refer to Section 1.3.3. (For inverters of certain capacities, the PWM carrier frequency (ζF) must be set 4 kHz or below.)
3. Use high frequency remedial products for earth leakage breakers.
If you use equipment like this, there is no need to reduce the PWM carrier frequency.
4. If the sensors and CRT are affected, it can be remedied by reducing the PWM carrier frequency described in 1 above, but if this cannot be remedied because of the increase in the motor's electric magnetic noise, please consult with your supplier.

* Cautions for applying models with a built-in noise filter.

As the inverter is equipped with a built-in noise filter, the leakage current value at power supply of (single-phase earth) can be larger than normal inverter, so be careful.

<Standard leakage current value (single-phase earth)>

VFPS1-2004PL~2150PM: Approx. 15mA

VFPS1-2185PM~2450PM: Approx. 1mA

(2) Affects of leakage current across supply lines

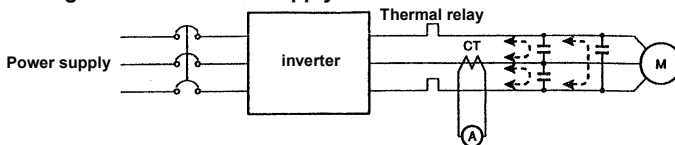

Leakage current path across wires

(1) Thermal relays

The high frequency component of current leaking into electrostatic capacity between inverter output wires will increase the effective current values and make externally connected thermal relays operate improperly. If the motor cables are more than 50m long, external thermal relay may operate improperly with models having motors of low rated current, especially the 400V class low capacity (3.7kW or less) models, because the leakage current will be high in proportion to the motor rating.

Remedies:

1. Use the electronic thermal overload built into the inverter.
The setting of the electronic thermal overload is done using parameter \overline{ULN} or tHr .
2. Reduce the inverter's PWM carrier frequency. However, that will increase the motor's acoustic noise.
The setting of PWM carrier frequency is done with the parameter ζF .
3. This can be improved by installing 0.1 μ F-0.5 μ F-1000Vdc film capacitor to the input/output terminals of each phase in the thermal overload relay.

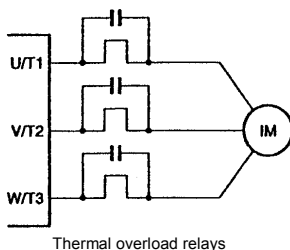

Thermal overload relays

(2) CT and ammeter

If a CT and ammeter are connected externally to measure inverter output current, the leakage current's high frequency component may destroy the ammeter or CT. If the motor cables are more than 50m long, it will be easy for the high frequency component to pass through the externally connected CT and be superimposed on and burn the ammeter with models having motors of low rated current, especially the 400V class low capacity (3.7kW or less) models, because the leakage current will increase in proportion to the motor's rated current.



Remedies:



1. Use a meter output terminal in the inverter control circuit.
The output current can be output on the meter output terminal (AM, FM). If the meter is connected, use an ammeter of 1mAcd full scale or a voltmeter of 7.5Vdc-1mA full scale.
Inverter output terminal (FM) can be changed to 0-20mAcd (4-20mAcd) with $F \overline{B} \overline{B} \overline{1}$.
2. Use the monitor functions built into the inverter.
Use the monitor functions on the panel built into the inverter to check current values.

1.4.4 Installation

■ Installation environment

The VF-PS1 Inverter is an electronic control instrument. Take full consideration to installing it in the proper operating environment.

 Danger	
 Prohibited	<ul style="list-style-type: none"> Do not place any inflammable substances near the VF-PS1 Inverter. If an accident occurs in which flames are emitted, this could lead to fire.
 Mandatory	<ul style="list-style-type: none"> Operate under the environmental conditions prescribed in the instruction manual. Operation under any other conditions may result in malfunction.

 Caution	
 Prohibited	<ul style="list-style-type: none"> Do not install the VF-PS1 Inverter in any location subject to large amounts of vibration. This could cause the unit to fall, resulting in bodily injury.
 Mandatory	<ul style="list-style-type: none"> Check to make sure that the input power supply voltage is +10%, -15% of the rated supply voltage written on the rating label ($\pm 10\%$ when the load is 100% in continuous operation). If the input power voltage is not +10%, -15% of the rated power voltage ($\pm 10\%$ when the load is 100% in continuous operation) this may result in fire.



- Do not install in any location of high temperature, high humidity, moisture condensation and freezing.
- Avoid locations where there is exposure to water and/or where there may be large amounts of dust and metallic fragments.
- Do not install the inverter where there are gases that corrode metal or solvents that adversely affect plastic.

- Operate in areas where ambient temperature ranges from -10°C to 60°C.

200V class 0.4~45kW, 400V class 0.75~75kW: When installing the inverter where the ambient temperature will rise above 40°C, remove the protective cover from the top cover. When installing the inverter where the ambient temperature will rise above 50°C, remove the protective cover from the top of it and operate it at a current lower than the rated one.

200V class 55~90kW, 400V class 90~630kW: When installing the inverter where the ambient temperature will rise above 45°C, operate it at a current lower than the rated one.

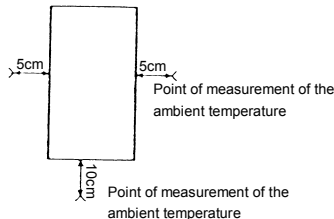
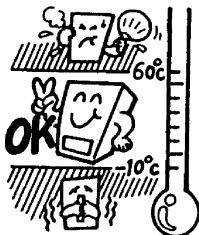

Note: The inverter is a heat-emitting body. Make sure to provide proper space and ventilation when installing in cabinet. When installing inside a cabinet, we recommend the removal of the protective cover.

- Do not install in any location that is subject to large amounts of vibration.



Note: If the VF-PS1 Inverter is installed in a location that is subject to vibration, anti-vibration measures are required.
Please consult with your supplier about these measures.

1

- If the VF-PS1 Inverter is installed near any of the equipment listed below, provide measures to insure against errors in operation.

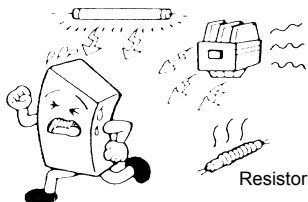



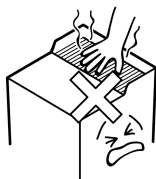

- Solenoids: Attach surge suppressor on coil.
- Brakes: Attach surge suppressor on coil.
- Magnetic contactors: Attach surge suppressor on coil.
- Fluorescent lamps: Attach surge suppressor on coil.
- Resistors: Place far away from VF-PS1 Inverter.

- Do not touch the heat sink, because it becomes hot during operation.



■ How to install

 Danger	
 Prohibited	<ul style="list-style-type: none"> • Do not operate the inverter if it is damaged or any component is missing. This can result in electric shock or fire. Call your local sales agency for repairs.
 Mandatory	<ul style="list-style-type: none"> • Must be installed in non-inflammables such as metals. The rear panel gets very hot. If installation is in an inflammable object, this can result in fire. • Do not operate with the front panel cover removed. This can result in electric shock. • An emergency stop device must be installed that fits with system specifications. (e.g. shut off input power then engage mechanical brake) • Operation cannot be stopped immediately by the inverter alone, thus risking an accident or injury. • All options used must be those specified by Toshiba. • The use of any other option may result in an accident.

 Caution	
 Mandatory	<ul style="list-style-type: none"> • The main unit must be installed on a base that can bear the unit's weight. If the unit is installed on a base that cannot withstand that weight, the unit may fall resulting in injury. • If braking is necessary (to hold motor shaft), install a mechanical brake. The brake on the inverter will not function as a mechanical hold, and if used for that purpose, injury may result.

Install the inverter in a well-ventilated indoor place and mount it on a flat metal plate in portrait orientation.

If you are installing more than one inverter, the separation between inverters should be at least 5cm, and they should be arranged in horizontal rows.

If the inverters are horizontally arranged with no space between them (side-by-side installation), remove of the protective cover on top of the inverter. If the inverters are installed where the ambient temperature is above 45 or 50°C, which depends on their capacities, the current needs to be lowered.

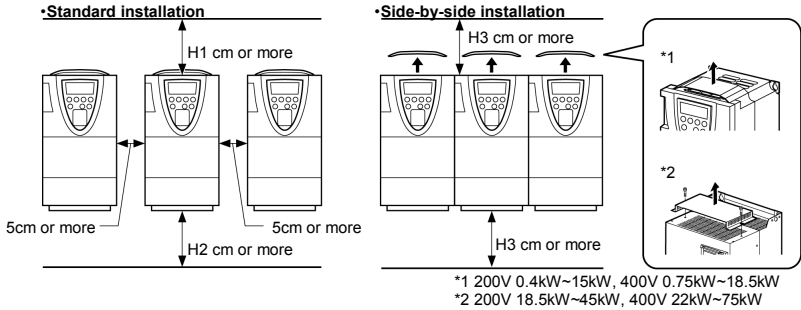

	H1(cm)	H2(cm)	H3(cm)
200V 90kW or smaller 400V 132kW or smaller	10	10	10
400V 160, 220kW	15	15	25
400V 250~315kW	20	15	25
400V 400, 500kW	30	25	25
400V 630kW	40	25	25

The space shown in the diagram is the minimum allowable clearance. Make the space on top and bottom as large as possible to allow for air passage. For models designed for 200V-90kW and 400V-132kW motors or larger, leave a space of 30cm or more above and below the inverter.

Note: Do not install in any location where there is high humidity or high temperatures and where there are large amounts of dust and metallic fragments. If you are going to install the equipment in any area that presents a potential problem, please consult with your supplier before doing so.

■ Current reduction curve

Depending on the way in which the inverter is installed, the ambient temperature and the carrier frequency setting, you may need to reduce the inverter's continuous output current.

Reduction rates vary depending on the capacity of the inverter. The capacities shown in these diagrams are capacities with the highest reduction rates. Refer to section 12, you can find 100 % value of output current there.

The VFPS1 has the function of adjusting the inverter's overload resistance automatically according to the ambient temperature, as shown in the figure below. This function enhances the inverter's overload resistance when the ambient temperature is low. To use this function, set the parameter $F531$ to 1.

If $F531$ is set to 0 (default setting), protection will be provided by reducing the output current (approximate linear reduction) in 12, "Specifications," by adjusting the PWM carrier frequency or at the occurrence of the event shown in the diagram below, which occurs first.

200V 0.4~15kW
400V 0.75~18.5kW
(See lines shown in - - - for 2.2kW)

•Standard installation with top cover

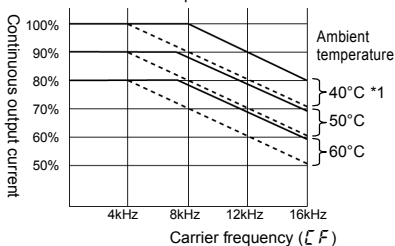

•Standard installation without top cover or side-by-side installation without top cover

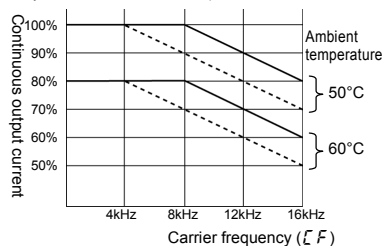

*1: It is current reductions curve, when setting a parameter $F531$ as 1.

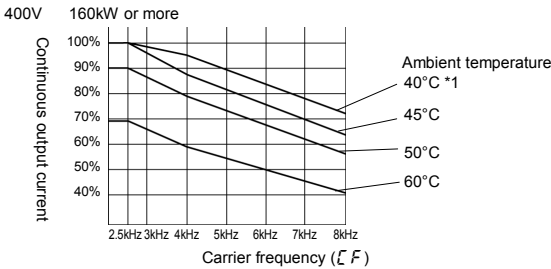
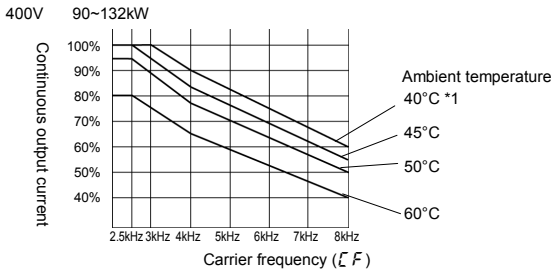
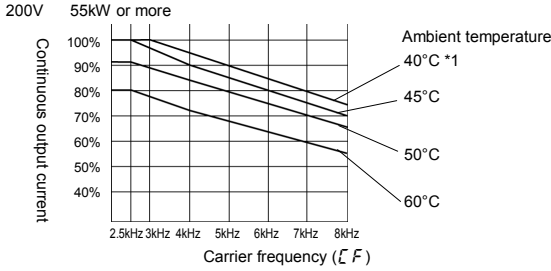
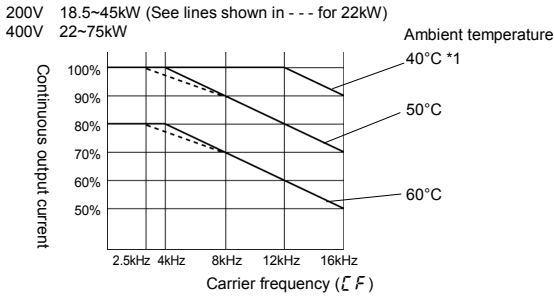

*1: It is current reductions curve, when setting a parameter $F \delta \beta$ as 1 .

■ Calorific values of the inverter and the required ventilation

The energy loss when the inverter converts power from AC to DC and then back to AC is about 5%. In order to suppress the rise in temperature inside the cabinet when this loss becomes heat loss, the interior of the cabinet must be ventilated and cooled.

The amount of forced air-cooling ventilation required and the necessary heat exchange surface area when operating in a sealed cabinet according to motor capacity are as follows.

Voltage class	Applicable Motor (kW)	Calorific values (W)	Amount of forced air cooling ventilation required (m ³ /min)	Heat exchange surface area required for sealed storage cabinet (m ²)
200V	0.4	50	0.29	1.0
	0.75	70	0.40	1.4
	1.5	113	0.65	2.3
	2.2	135	0.78	2.7
	3.7	191	1.1	3.8
	5.5	307	1.8	6.2
	7.5	408	2.4	8.2
	11	593	3.4	11.9
	15	692	4.0	13.9
	18.5	800	4.6	16.0
	22	865	5.0	17.3
	30	1140	6.6	22.8
	37	1340	7.7	26.8
	45	1570	9.0	31.4
	55	1720	9.9	34.4
	75	2240	12.8	44.8
90	2700	15.4	54.0	
400V	0.75	57	0.33	1.2
	1.5	82	0.47	1.7
	2.2	112	0.64	2.3
	3.7	136	0.78	2.8
	5.5	262	1.5	5.3
	7.5	328	1.9	6.6
	11	448	2.6	9.0
	15	577	3.3	11.6
	18.5	682	3.9	13.7
	22	720	4.2	14.4
	30	980	5.6	19.6
	37	1180	6.8	23.6
	45	1360	7.8	27.2
	55	1560	9.0	31.2
	75	2330	13.4	46.6
	90	2410	13.8	48.2
	110	2730	15.6	54.6
	132	3200	18.3	64.0
	160	3980	22.7	79.6
	220	5404	30.8	108.1
250	6279	35.8	125.6	
280	6743	38.4	134.9	
315	7749	44.2	155.0	
400	9433	53.8	188.7	
500	11853	67.6	237.1	
630	14751	84.1	295.0	

Note1: The heat loss for the optional external devices (input reactor, DC reactor, radio noise reduction filters, etc.) is not included in the calorific values in the table. With the exception of inverters indented for motors with capacities of 400kW and more, in which case the calorific value of the DC reactor is included.

Note2: Each calorific value in the table refers to the quantity of heat that an inverter produces when it is operated continuously at the factory default f_c (carrier frequency) under a load factor of 100%.

■ Panel designing taking into consideration the effects of noise

The inverter generates high frequency noise. When designing the control panel setup, consideration must be given to that noise. Examples of measures are given below.

- Wire so that the main circuit wires and the control circuit wires are separated. Do not place them in the same conduit, do not run them parallel, and do not bundle them.
- Provide shielding and twisted wire for control circuit wiring.
- Separate the input (power) and output (motor) wires of the main circuit. Do not place them in the same conduit, do not run them parallel, and do not bundle them.
- Ground the inverter ground terminals (\perp).
- Install surge suppressor on any magnetic contactor and relay coils used around the inverter.
- Install noise filters if necessary.



■ Installing more than one unit in a cabinet

If you are installing two or more inverters in one cabinet, pay attention to the following.

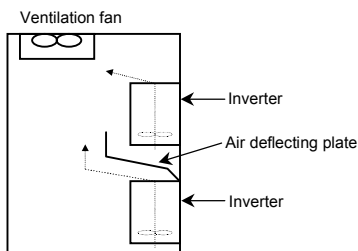

- Inverters may be installed side by side with each other with no space left between them.
- When installing inverters side by side, remove the protective cover on the top surface of each inverter.
The output current may need to be reduced, depending on the ambient temperature and the carrier frequency, so see "How to install" in this section.
- Ensure a space of at least 20cm on the top and bottom of the inverters.
- Install an air deflecting plate so that the heat rising up from the inverter on the bottom does not affect the inverter on the top.







2. Connection equipment



 Danger	
 Disassembly prohibited	<ul style="list-style-type: none"> Never disassemble, modify or repair. This can result in electric shock, fire and injury. For repairs, call your sales agency.
 Prohibited	<ul style="list-style-type: none"> Don't stick your fingers into openings such as cable wiring hole and cooling fan covers. This can result in electric shock or other injury. Don't place or insert any kind of object into the inverter (electrical wire cuttings, rods, wires). This can result in electric shock or fire. Do not allow water or any other fluid to come in contact with the inverter. That may result in electric shock or fire.

2

 Caution	
 Prohibited	<ul style="list-style-type: none"> Do not transport the inverter with its front door detached. The covers may come off and the unit will drop out resulting in injury.
 Mandatory	<ul style="list-style-type: none"> Models (20kg or more in weight) designed for 200V-18.5kW or larger and 400V-22kW or larger should be carried by at least two persons. Carrying it alone could cause injury.

2.1 Cautions on wiring

 Danger	
 Prohibited	<ul style="list-style-type: none"> Never remove the front cover when power is on or open door if enclosed in a cabinet. The unit contains many high voltage parts and contact with them will result in electric shock.
 Mandatory	<ul style="list-style-type: none"> Turn power on only after attaching the front cover or closing door if enclosed in a cabinet. If power is turned on without the front cover attached or closing door if enclosed in a cabinet. This can result in electric shock or other injury. Electrical construction work must be done by a qualified expert. Connection of input power by someone who does not have that expert knowledge may result in fire or electric shock. Connect output terminals (motor side) correctly. If the phase sequence is incorrect, the motor will operate in reverse and that may result in injury. Wiring must be done after installation. If wiring is done prior to installation that may result in injury or electric shock. The following steps must be performed before wiring. <ol style="list-style-type: none"> Shut off all input power. Wait at least 15 minutes and check to make sure that the charge lamp is no longer lit. Use a tester that can measure DC voltage (800 VDC or more), and check to make sure that the voltage to the DC main circuits (between PA/+ and PC/-) is 45 V or less. If these steps are not properly performed, the wiring will cause electric shock. Tighten the screws on the terminal board to specified torque. If the screws are not tightened to the specified torque, it may lead to fire.
 Be Grounded	<ul style="list-style-type: none"> Ground must be connected securely. If the ground is not securely connected, it could lead to electric shock or fire when a malfunction or current leak occurs.

 Caution	
 Prohibited	<ul style="list-style-type: none"> • Do not attach devices with built-in capacitors (such as noise filters or surge absorber) to the output (motor side) terminal. This could cause a fire.

■ Preventing radio noise

To prevent electrical interference such as radio noise, separately bundle wires to the main circuit's power terminals (R/L1, S/L2, T/L3) and wires to the motor terminals (U/T1, V/T2, W/T3).

■ Control and main power supply

The control power supply and the main circuit power supply for the VF-PS1 are the same. If a malfunction or trip causes the main circuit to be shut off, control power will also be shut off.

If you want to keep the control circuit alive when the main circuit shuts off due to trouble or tripping, you use an optional control power supply backup unit (CPS002Z).

■ Wiring

- Because the space between the main circuit terminals is small use sleeved pressure terminals for the connections. (stripped wires may be connected directly for 200V/18.5kW to 200V/45kW models and 400V/22kW to 400V/75kW models). Connect the terminals so that adjacent terminals do not touch each other.

- For ground terminal G/E use wires of the size that is equivalent to or larger than those given in table below and always ground the inverter.

Use as large and short a ground wire as possible and wire it as close as possible to the inverter.



Voltage class	Applicable Motor	Grounding wire size (AWG) [Note]	Grounding wire size (mm ²) [Note]
200V	0.4~2.2 kW	14	2.5
	3.7kW	12	4
	5.5 kW	10	6
	7.5 kW	10	10
	11, 15 kW	10	16
	18.5, 22 kW	8	16
	30 kW	6	25
	37, 45 kW	6	35
	55 kW	1/0	70
400V	75 kW	1/0	95
	90 kW	1/0	120
	0.75~3.7kW	14	2.5
	5.5 kW	12	2.5
	7.5 kW	12	4
	11 kW	10	6
	15~18.5 kW	10	10
	22 kW	10	8
	30 kW	10	16
	37, 45 kW	8	16
	55 kW	6	25
	75 kW	6	35
	90 kW	2	70
	110 kW	2	95
	132 kW	1	95
	160 kW	1	120
	220~250 kW	2/0	150
280~315 kW	3/0	120×2	
400 kW	4/0	150×2	
500 kW	250MCM	150×2	
600 kW	350MCM	185×2	

Note1: The recommended cable size is that of the cable (e.g. 600V class, HIV cable) with continuous maximum permissible temperature of 75°C. The ambient temperature is assumed to be 50°C or below for 200V-45kW or less models and 400V-75kW or less models, or 45°C for 200V-55kW or more models and 400V-90kW or more models. (The interconnect cable length is assumed to be 30m or less.)

- Refer to the table in Section 10.1 for wire sizes.
- The length of the main circuit wire in Section 10.1 should be no longer than 30m. If the wire is longer than 30m, the wire size (diameter) must be increased.
- Tighten the screws on the terminal board to specified torque.

Recommended tightening torque for screws on the terminal board		
	N·m	lb·ins
M3	0.6	5.3
M4	1.4	12.4
M5	3.0	26.6
M6	5.4	47.8
M8	12.0	106
M10	24.0	212
M12	41.0	360

2.2 Standard connections

 Danger	
 Prohibited	<ul style="list-style-type: none"> • Do not connect input power to the output (motor side) terminals (U/T1, V/T2, W/T3). Connecting input power to the output could destroy the inverter or cause a fire. • Do not connect a regenerative braking resistor to any DC terminal (between PA/+ and PC/-, or between PO and PC/-). If a braking resistor is connected by mistake, it may overheat extremely and cause a fire. Connect resistors as directed in the instructions for Section 5.19. • Within 15 minutes after turning off input power, do not touch wires of devices (MCCB) connected to the input side of the inverter. That could result in electric shock.
 Be Grounded	<ul style="list-style-type: none"> • Ground must be connected securely. If the ground is not securely connected, it could lead to electric shock or fire when a malfunction or current leak occurs.

[Standard connection diagram – sink logic]

The figure below shows an example of typical wiring in the main circuit 200V 0.4-45kW/400V 0.75-75kW inverter.

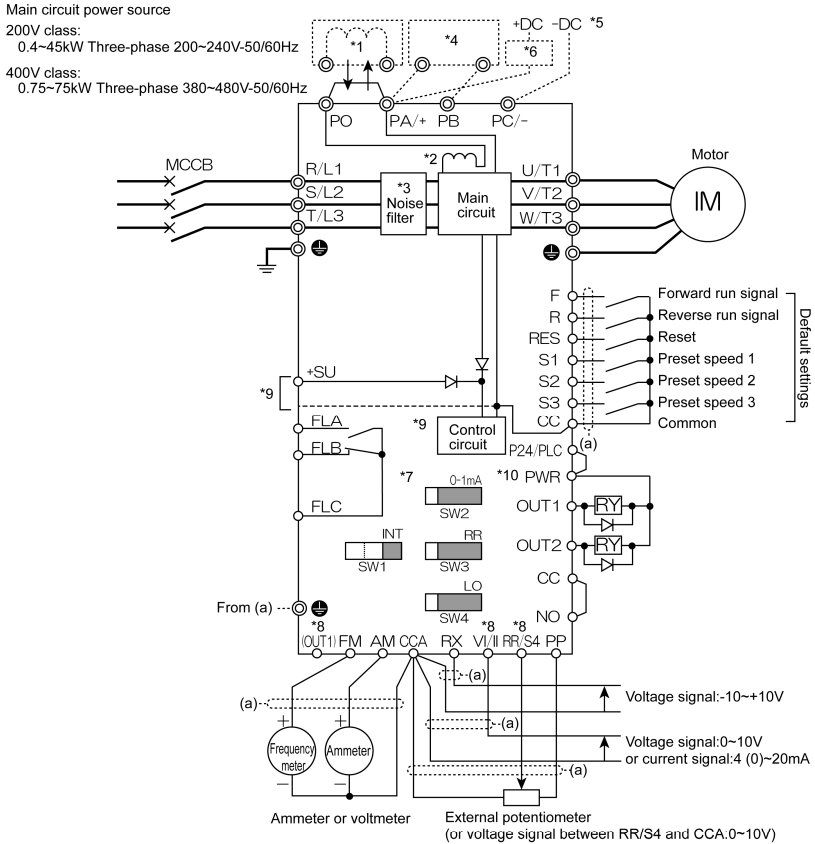

- *1: The inverter is shipped with the terminals PO and PA/+ shorted with a bar (200V-45kW or smaller, 400V-75kW or smaller). Remove this shorting bar when installing a DC reactor (DCL).
- *2: The DC reactor is built in for models 200V-11kW~45kW and 400V-18.5kW~75kW.
- *3: The noise filter is built in for models 200V-45kW or smaller and all of 400V.
- *4: External braking resistor (option). Dynamic braking drive circuit built-in (GTR7) as standard for models 220kW or smaller.
- *5: To supply a DC power, connect the cables to the PA/+ and PC/- terminals.
- *6: If you want to use a DC power supply to operate the inverter (200V: 18.5kW or more, 400V: 22kW or more), be sure to contact your supplier customer support center, because an inrush current limiting circuit is required in such a case.
- *7: ⇒ Refer to Section 2.3.2 for chip switch functions.
- *8: The functions assigned to terminals OUT1, VI/II and RR/S4 can be switched by changing parameter settings. ⇒ For details refer to Section 2.3.2.
- *9: To supply control power from an external power supply for backing up the control power supplied from the inverter, an optional control power backup device (CPS002Z) is required. In such a case, the backup device is used at the same time with the internal power supply of the inverter. The optional control power backup unit can be used with both 200V and 400V models. To back up control power, set the parameter F 5 4 7 (Control power supply backup option failure monitoring) properly. ⇒ For more information, refer to 6.33.22.
- *10: For PWR connection conforming to safety standards, refer to Section 9.3.

[Standard connection diagram - sink logic]

The figure below shows an example of typical wiring in the main circuit 200V 55- 90kW/400V 90-400kW inverter.

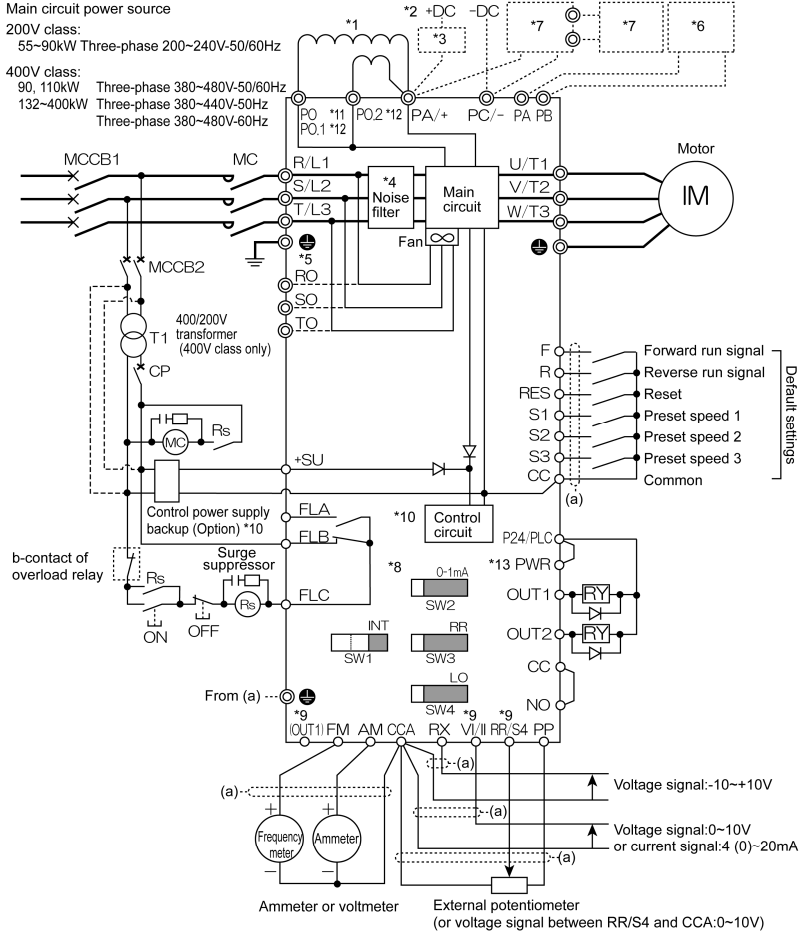

- *1: Be sure to connect the DC reactor.
- *2: To supply a DC power, connect the cables to the PA/+ and PC/- terminals.
- *3: If you want to use a DC power supply to operate the inverter, be sure to contact your supplier customer support center, because an inrush current limiting circuit is required in such a case.
- *4: The noise filter is built in for models all of 400V.
- *5: For models 200V-90kW and 400V-132kW or larger, three-phase power input is necessary to drive the fan if you want to use a DC power supply.
- *6: Every 200V model of any capacity and every 400V model with a capacity of 220kW or less come with dynamic braking unit drive circuits (GTR7) built into them as standard equipment, so if your inverter is among these models, connect an external braking resistor (optional) alone.
- *7: If you are using a 400V/250kW model or larger, use a braking unit (optional) and an external braking resistor (optional) in combination.
- *8: ⇒ Refer to Section 2.3.2 for switch functions.
- *9: The functions assigned to terminals OUT1, VI/II and RR/S4 can be switched by changing parameter settings.
⇒ For details refer to Section 2.3.2.
- *10: To supply control power from an external power supply for backing up the control power supplied from the inverter, an optional control power backup device (CPS002Z) is required. In such a case, the backup device is used at the same time with the internal power supply of the inverter.
The optional control power backup unit can be used with both 200V and 400V models.
To back up control power, set the parameter $F \ 5 \ 4 \ 7$ (Control power supply backup option failure monitoring) properly.
⇒ For more information, refer to 6.33.22.
- *11: For models 200V-55-90kW and 400V-90-315kW.
- *12: For models 400V-400kW.
- *13: For PWR connection conforming to safety standards, refer to Section 9.3.

[Standard connection diagram - sink logic]

The figure below shows an example of typical wiring in the main circuit 400V 500-630kW inverter.

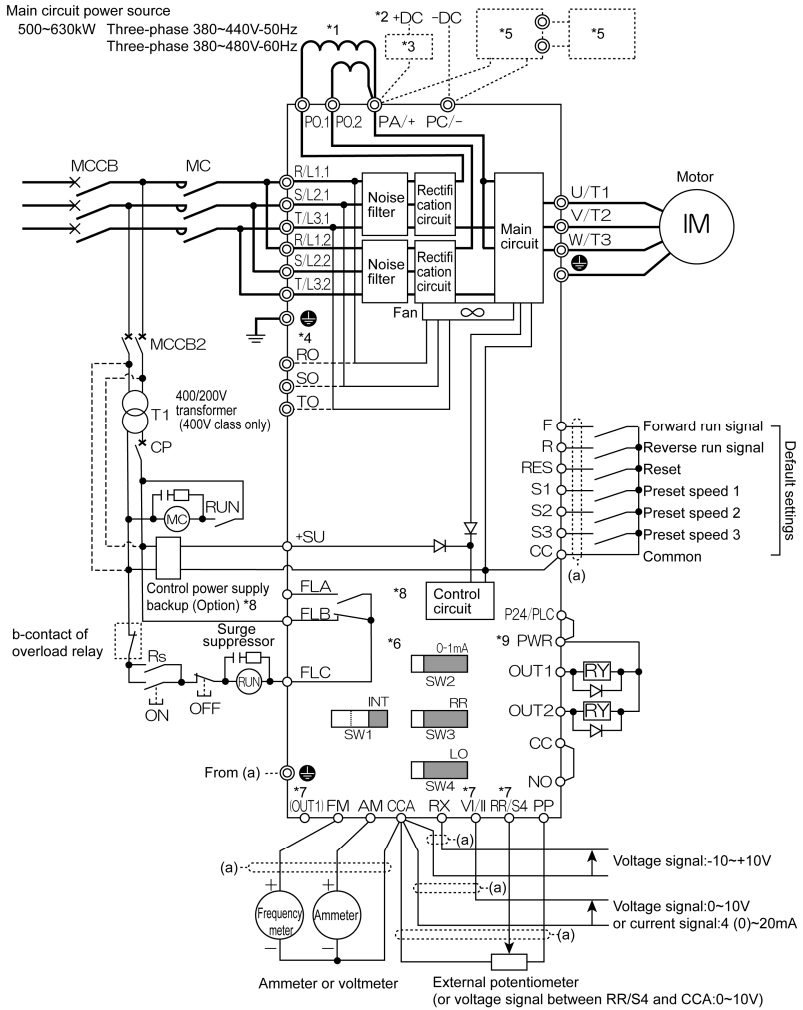

- *1: Be sure to connect the DC reactor.
- *2: To supply a DC power, connect the cables to the PA/+ and PC/- terminals.
- *3: If you want to use a DC power supply to operate the inverter, be sure to contact your supplier customer support center, because an inrush current limiting circuit is required in such a case.
- *4: Three-phase power input is necessary to drive the fan if you want to use a DC power supply.
- *5: Use a braking unit (optional) and an external braking resistor (optional) in combination.
- *6: ⇒ Refer to Section 2.3.2 for switch functions.
- *7: The functions assigned to terminals OUT1, VI/II and RR/S4 can be switched by changing parameter settings. ⇒ For details refer to Section 2.3.2.
- *8: To supply control power from an external power supply for backing up the control power supplied from the inverter, an optional control power backup device (CPS002Z) is required. In such a case, the backup device is used at the same time with the internal power supply of the inverter.
To back up control power, set the parameter $F547$ (Control power supply backup option failure monitoring) properly.
⇒ For more information, refer to 6.33.22.
- *9: For PWR connection conforming to safety standards, refer to Section 9.3.

[Standard connection diagram - source logic]

The figure below shows an example of typical wiring in the main circuit 200V 55, 90kW/400V 90-400kW inverter.

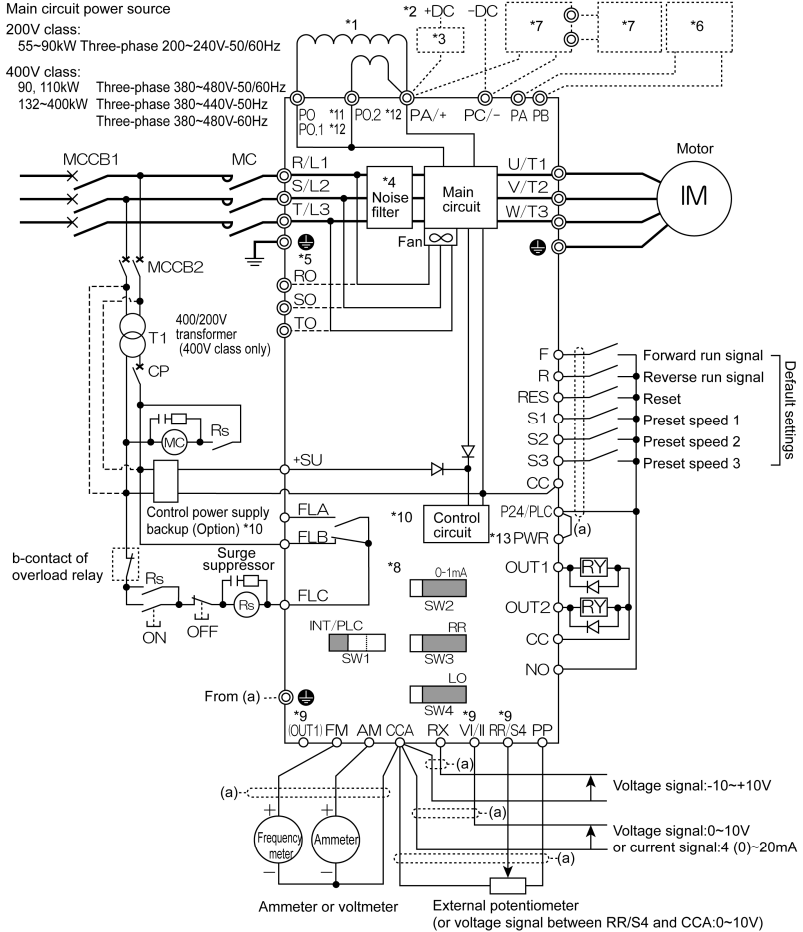

- *1: Be sure to connect the DC reactor.
- *2: To supply a DC power, connect the cables to the PA/+ and PC/- terminals.
- *3: If you want to use a DC power supply to operate the inverter, be sure to contact your supplier customer support center, because an inrush current limiting circuit is required in such a case.
- *4: The noise filter is built in for models all of 400V.
- *5: For models 200V-75kW and 400V-110kW or larger, three-phase power input is necessary to drive the fan if you want to use a DC power supply.
- *6: Every 200V model of any capacity and every 400V model with a capacity of 160kW or less come with dynamic braking unit drive circuits (GTR7) built into them as standard equipment, so if your inverter is among these models, connect an external braking resistor (optional) alone.
- *7: If you are using a 400V/250kW model or larger, use a braking unit (optional) and an external braking resistor (optional) in combination.
- *8: ⇒ Refer to Section 2.3.2 for switch functions.
- *9: The functions assigned to terminals OUT1, VI/II and RR/S4 can be switched by changing parameter settings.
⇒ For details refer to Section 2.3.2.
- *10: To supply control power from an external power supply for backing up the control power supplied from the inverter, an optional control power backup device (CPS002Z) is required. In such a case, the backup device is used at the same time with the internal power supply of the inverter.
The optional control power backup unit can be used with both 200V and 400V models.
To back up control power, set the parameter $F547$ (Control power supply backup option failure monitoring) properly.
⇒ For more information, refer to 6.33.22.
- *11: For models 200V-55-90kW and 400V-90-315kW.
- *12: For models 400V-400kW.
- *13: For PWR connection conforming to safety standards, refer to Section 9.3.

[Standard connection diagram - source logic]

The figure below shows an example of typical wiring in the main circuit 400V 500-630kW inverter.

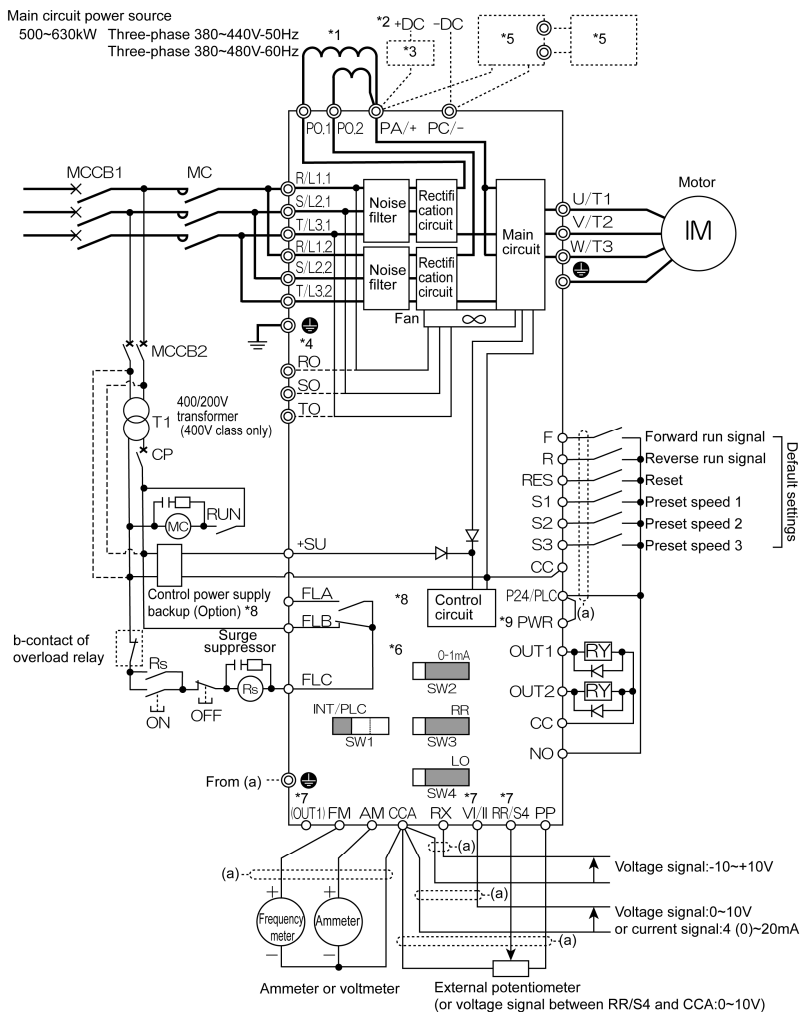

- *1: Be sure to connect the DC reactor.
- *2: To supply a DC power, connect the cables to the PA/+ and PC/- terminals.
- *3: If you want to use a DC power supply to operate the inverter, be sure to contact your supplier customer support center, because an inrush current limiting circuit is required in such a case.
- *4: Three-phase power input is necessary to drive the fan if you want to use a DC power supply.
- *5: Use a braking unit (optional) and an external braking resistor (optional) in combination.
- *6: Refer to Section 2.3.2 for switch functions.
- *7: The functions assigned to terminals OUT1, VI/II and RR/S4 can be switched by changing parameter settings. For details refer to Section 2.3.2.
- *8: To supply control power from an external power supply for backing up the control power supplied from the inverter, an optional control power backup device (CPS002Z) is required. In such a case, the backup device is used at the same time with the internal power supply of the inverter.
To back up control power, set the parameter $F 5 4 7$ (Control power supply backup option failure monitoring) properly. For more information, refer to 6.33.22.
- *9: For PWR connection conforming to safety standards, refer to Section 9.3.

2.3 Description of terminals

2.3.1 Main circuit terminals

This diagram shows an example of wiring of the main circuit. Use options if necessary.

Power supply and motor connections

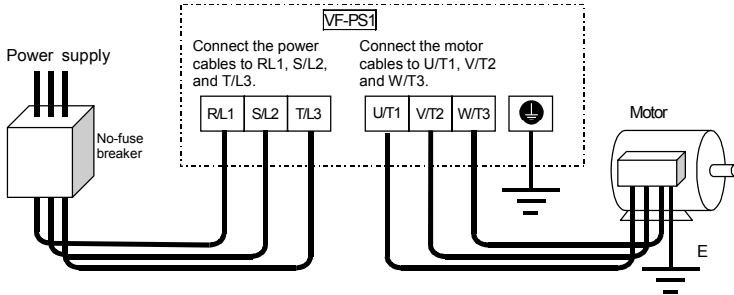

Connection with peripheral equipment

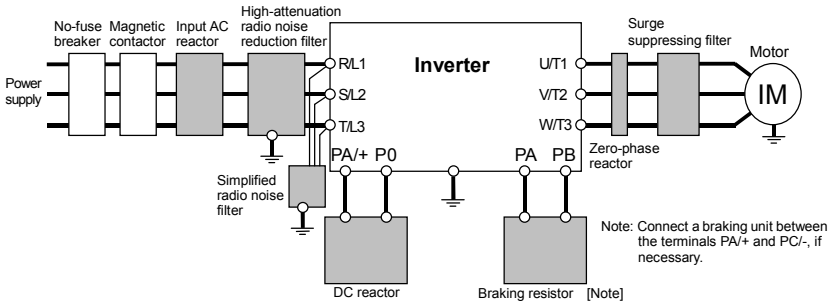

Main circuit

Terminal symbol	Terminal function
	Grounding terminal for inverter casing
R/L1, S/L2, T/L3 (R/L1.1, S/L2.1, T/L3.1, R/L1.2, S/L2.2, T/L3.2) *1	Power input terminal 200V class: 0.4~90kW Three-phase 200~240V-50/60Hz 400V class: 0.75~110kW Three-phase 380~480V-50/60Hz 132~630kW Three-phase 380~440V-50Hz Three-phase 380~480V-60Hz
U/T1, V/T2, W/T3	Connect to a (3-phase induction) motor.
PA/+, PB (PA, PB) *2	Connect a braking resistor. Change the parameters P^b_b , P^b_r and $P^b_c P$ if necessary. 250kW models and larger are not equipped with terminal PB.
PC/-	This is a negative potential terminal in the internal DC main circuit. DC power supply can be input across the PA/+ terminals (positive potential). (For 200V-18.5kW or more models, and 400V-22kW or more models, an optional circuit is needed to suppress a rush current.)
PO, PA/+	Terminals for connecting a DC reactor (DCL: optional external device). Shorted by a short bar when shipped from the factory (200V: 45kW or smaller, 400V: 75kW or smaller). Before installing DCL, remove the short bar. (The rating of 400V-500kW and 630 kW have the double terminals of PO.)
RO, SO, TO	200V class: 90kW 400V class: 132kW~630kW Inverter's cooling fan power input terminals. When using a DC power supply, connect three-phase power cables. When using DC power for the main circuit, be sure to connect a three-phase power supply to these terminals.

*1: Value in () 400V-500, 630kW.

*2: Value in () 200V-55kW or larger, 400V-90~220kW.

2.3.2 Control circuit terminal block

The control circuit terminal block is common to all equipment.

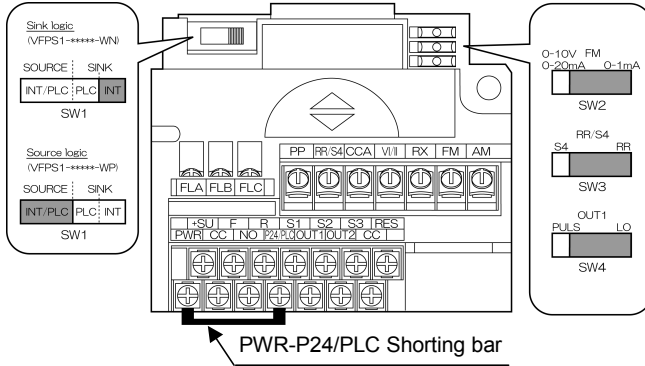

⇒ How to set input terminal function, refer to section 7.

2

Terminal symbol	Input/output	Function (Sink logic) VFPS1-****-WN	Function (Source logic) VFPS1-****-WP	Electrical specifications	
F	Input	Shorting across F-CC causes forward rotation; open causes deceleration stop. (Across PWR-P24/PLC is short state.)	Shorting across F-P24/PLC causes forward rotation; open causes deceleration stop. (Across PWR-P24/PLC is short state.)	Voltage free contact input 24Vdc-5mA or less Lan current signal. Choose low current contacts to avoid poor attaching. *Sink/source selectable with SW1 Sink input ON: Less than DC10V OFF: DC16V or more Source input ON: DC11V or more OFF: Less than DC5V Note: Even when an external power supply is used (in sink logic mode, i.e., when SINK (PLC) is selected), connect the reference potential-side (OV, side) cable from the power supply to the CC terminal.	
R	Input	Shorting across R-CC causes reverse rotation; open causes deceleration stop. (Across PWR-P24/PLC is short state.)	Shorting across R-P24/PLC causes reverse rotation; open causes deceleration stop. (Across PWR-P24/PLC is short state.)		
RES	Input	Shorting and then opening RES-CC cancels the status held by an inverter protective function. When the inverter is operating normally, shorting and then opening RES-CC produces no effect.	Shorting and then opening RES-P24/PLC cancels the status held by an inverter protective function. When the inverter is operating normally, shorting and then opening RES-P24/PLC produces no effect.		
S1	Input	Shorting across S1-CC causes preset speed operation.	Shorting across S1-P24/PLC causes preset speed operation.		
S2	Input	Shorting across S2-CC causes preset speed operation.	Shorting across S2-P24/PLC causes preset speed operation.		
S3	Input	Shorting across S3-CC causes preset speed operation.	Shorting across S3-P24/PLC causes preset speed operation.		
RR/S4	Input	SW3: When SW3 is in the S4 position, S4 and CC are shorted and preset speed operation is selected.	SW3: When SW3 is in the S4 position, S4 and P24/PLC are shorted and preset speed operation is selected.		
SW1=SINK (INT): Sink logic (When the internal 24V power supply is used)		SW1=SINK (PLC): Sink logic (When an external 24V power supply is used)		SW1=SOURCE (INT/PLC): Source logic (When the internal 24V power supply or an external 24V power supply is used)	
<p>If SW1 is set to 1</p>		<p>If SW1 is set to 2</p>		<p>If SW1 is set to 3</p>	

Terminal symbol	Input/output	Function (Sink Source logic)	Electrical specifications	Inverter internal circuits
PWR *2	Input	If P24/PLC and PWR are short-circuited, the motor is put into a standby state. And if the circuit between them is opened, the motor coasts and stops. These terminals can be used for interlock. This terminal is not a multifunction programmable input terminal. It is a terminal with the power removal function that complies with SIL II of the safety standard IEC61508 and the requirements for category 3 of EN954-1.	Regardless of the setting of SW1 ON: DC17V or more OFF: Less than DC2V (OFF: Coast stop)	
P24/ PLC	Output	24Vdc power output (when SW1 is in any position other than PLC) 24V internal output terminal	24Vdc-200mA	-
	Input	If SW1 is turned to the PLC position, this terminal can be used as a common terminal when an external power supply is used.	-	-
CC *1	Common to input/output	Digital signal equipotential (0V) terminal for the control circuit and equipotential (0V) terminal for an optional control power supply backup.	-	-
PP	Output	Analog input setting power output	10Vdc (Permissible load current:10mAdc)	
RR/S4	Input	SW3: Multifunction programmable analog input terminal when SW3 is in the RR position. Standard default setting:0~10Vdc input and 0~60Hz frequency.	10Vdc (Internal impedance:30 kΩ)	
VI/I	Input	Multifunction programmable analog input. Standard default setting: 0~10Vdc input and 0~60Hz frequency. This terminal can also be used as a 4~20mAcd (0~20mAcd) input terminal, if the parameter F_{I00} is set to 1.	10Vdc (Internal impedance:30 kΩ) 4~20mA (Internal impedance:242Ω)	
RX	Input	Multifunction programmable analog input. Standard default setting:0~±10Vdc input and 0~±60Hz frequency.	10Vdc (Internal impedance:22 kΩ)	
FM	Output	Multifunction programmable analog output. Standard default setting: output frequency Use this terminal to connect a 1mAcd full-scale ammeter. This terminal can also be used as a 0-10V (F_{50} $I=0$) or 0-20mA terminal (F_{50} $I=1$), if the SW2 switch is set to 0-10V/0-20mA side.	1mA full-scale DC ammeter (Allowable load resistance 7.5kΩ or less) or 7.5Vdc-1mA full-scale DC voltmeter 0-10V full-scale DC voltmeter (Allowable load resistance 500Ω or more)/0-20mA (4-20mA) Full-scale DC ammeter voltmeter (Allowable load resistance 500Ω or less)	
AM	Output	Multifunction programmable analog output. Standard default setting: output current Use this terminal to connect a 1mAcd full-scale ammeter or 7.5Vdc (10Vdc)-1mA full-scale voltmeter.	1mA full-scale DC ammeter (Allowable load resistance 7.5kΩ or less) or 7.5Vdc-1mA full-scale DC voltmeter	
OUT1	Output	Multifunction programmable open collector output. The default setting is to output a signal when output low speed threshold has been reached. Depending on the SW4 setting, pulses are output with frequencies of 1.00kHz to 43.20kHz. Standard default setting:3.84kHz	Open collector output 24Vdc-50mA *Sink logic/source logic switchable	
OUT2		Multifunction programmable open collector output. By default, it is set to output a signal indicating the completion of acceleration or deceleration.		
NO		Digital output signal equipotential (0V) terminal for the control circuit. It is isolated from the CC terminal.		

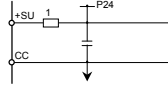
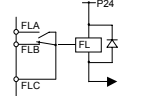
Terminal symbol	Input/output	Function (Sink Source logic)	Electrical specifications	Inverter internal circuits
CCA *1	Common to input/output	Analog input/output signal equipotential (0V) terminal for the control circuit.	-	-
+SU	Input	DC power input terminal for operating the control circuit. Connect a control power backup device (optional) between +SU and C.C.	Voltage:24Vdc±10% Use a power supply with a current rating of 1.05A or more.	
FLA FLB FLC	Output	Relay contact output. Contact rating Used to detect the activation of the inverter's protective function. Contact across FLA-FLC is closed and FLB-FLC is opened during protection function operation.	250Vac-2A 30Vdc-1A :at resistance load 250Vac-1A :cosφ=0.4	

*1: Although the CC terminal and the CCA terminal are not insulated, they should be used separately, one for the logic circuit and the other for the analog circuit

*2: The PWR terminal is not the same as the ST (standby signal input) terminal provided for conventional models. To use the ST function, assign it to a multifunction terminal (F, R, RES or S1 to S4) that is not currently in use.

Example: When assigning the ST function to the S3 terminal,

Set $F \ 1 \ 1 \ 0$ to 0 (to cancel its factory default setting: $5 = ST$ always active), and

Set $F \ 1 \ 1 \ 7$ to 5 (to assign the ST function to the S3 terminal).

These settings put the motor into a standby state if S3 and CC are short-circuited, or coast and stop the motor if the circuit between S3 and CC is opened.

→ For PWR connection conforming to safety standards, refer to Section 9.3.

2

SW	SW settings	Default setting (Settings marked with ●)	Function				
SW1	<table border="1"> <tr> <td>SOURCE</td> <td>SINK</td> </tr> <tr> <td>INT/PLC</td> <td>PLC INT</td> </tr> </table>	SOURCE	SINK	INT/PLC	PLC INT	● (-WN)	Setting for using the inverter's internal power supply in sink logic mode
	SOURCE	SINK					
	INT/PLC	PLC INT					
<table border="1"> <tr> <td>SOURCE</td> <td>SINK</td> </tr> <tr> <td>INT/PLC</td> <td>PLC INT</td> </tr> </table>	SOURCE	SINK	INT/PLC	PLC INT		Setting for using the inverter's external power supply in sink logic mode	
SOURCE	SINK						
INT/PLC	PLC INT						
<table border="1"> <tr> <td>SOURCE</td> <td>SINK</td> </tr> <tr> <td>INT/PLC</td> <td>PLC INT</td> </tr> </table>	SOURCE	SINK	INT/PLC	PLC INT	● (-WP)	Setting for operating the inverter in source logic mode	
SOURCE	SINK						
INT/PLC	PLC INT						
SW2	<table border="1"> <tr> <td>0-10V FM</td> <td>0-1mA</td> </tr> <tr> <td>0-20mA</td> <td></td> </tr> </table>	0-10V FM	0-1mA	0-20mA		●	Setting for using the analog output terminal FM to output current of 0-1mA
	0-10V FM	0-1mA					
0-20mA							
<table border="1"> <tr> <td>0-10V FM</td> <td>0-1mA</td> </tr> <tr> <td>0-20mA</td> <td></td> </tr> </table>	0-10V FM	0-1mA	0-20mA			Setting for using the analog output terminal FM to output current of 0-10V or 0-20mA (4-20mA) 0-10V ($F \ 5 \ 5 \ 1 = 0$) or 0-20mA ($F \ 5 \ 5 \ 1 = 1$) can be selected by changing parameter settings.	
0-10V FM	0-1mA						
0-20mA							
SW3	<table border="1"> <tr> <td>RR/S4</td> <td>RR</td> </tr> <tr> <td>S4</td> <td></td> </tr> </table>	RR/S4	RR	S4		●	Setting for using the input terminal RR/S4 as an analog input terminal (0-10Vdc)
	RR/S4	RR					
S4							
<table border="1"> <tr> <td>RR/S4</td> <td>RR</td> </tr> <tr> <td>S4</td> <td></td> </tr> </table>	RR/S4	RR	S4			Setting for using the input terminal RR/S4 as a contact input terminal	
RR/S4	RR						
S4							
SW4	<table border="1"> <tr> <td>OUT1</td> <td>LO</td> </tr> <tr> <td>PULS</td> <td></td> </tr> </table>	OUT1	LO	PULS		●	Setting for using the output terminal OUT1 as a logic output terminal When turning the switch to this position, always set the parameter $F \ 5 \ 5 \ 9$ to 0 (logic output).
	OUT1	LO					
PULS							
<table border="1"> <tr> <td>OUT1</td> <td>Lo</td> </tr> <tr> <td>PULS</td> <td></td> </tr> </table>	OUT1	Lo	PULS			Setting for using the output terminal OUT1 as a pulse output terminal When turning the switch to this position, always set the parameter $F \ 5 \ 5 \ 9$ to 1 (pulse output).	
OUT1	Lo						
PULS							

2

■ Sink logic/source logic (When inverter's internal power supply is used)

Current flowing out turns control input terminals on. These are called sink logic terminals.

The method generally used in Europe is source logic in which current flowing into the input terminal turns it on.

Sink logic terminals and source logic terminals are sometimes referred to as negative logic terminals and positive logic terminals, respectively.

Each logic is supplied with power from either the inverter's internal power supply or an external power supply, and its connections vary depending on the power supply used. Note that the PWR terminal is designed for safety purposes to work always in source logic mode, regardless of the setting of SW1.

<Examples of connections when the inverter's internal power supply is used>

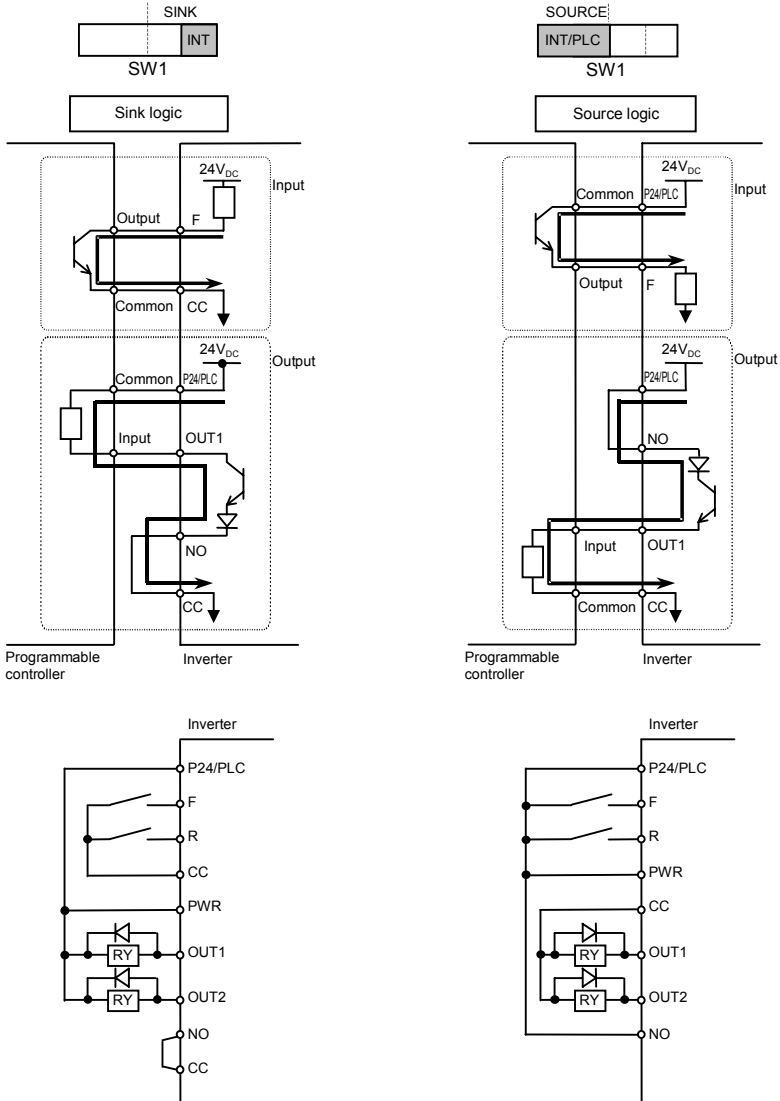

■ Sink logic/source logic (When an external power supply is used)

The P24/PLC terminal is used to connect to an external power supply or to insulate a terminal from other input or output terminals. Use the slide switch SW1 to switch between sink logic and source logic configurations. Note that the PWR terminal is designed for safety purposes to work always in source logic mode, regardless of the setting of SW1.
 <Examples of connections when an external power supply is used>

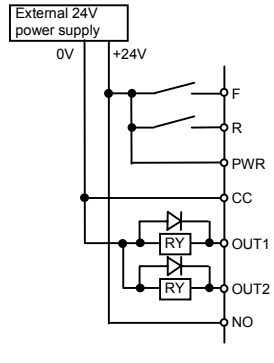
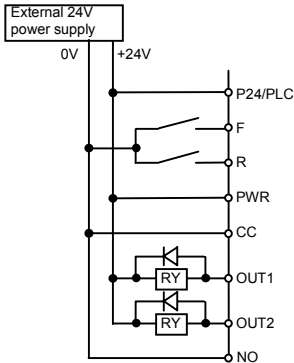
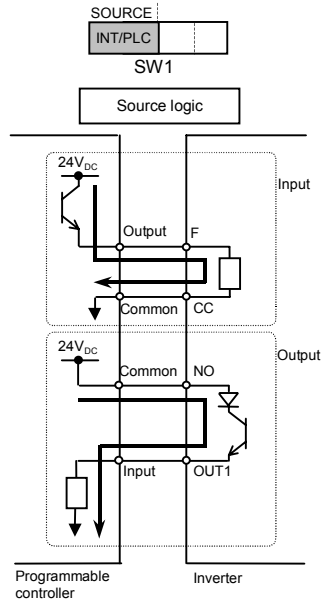
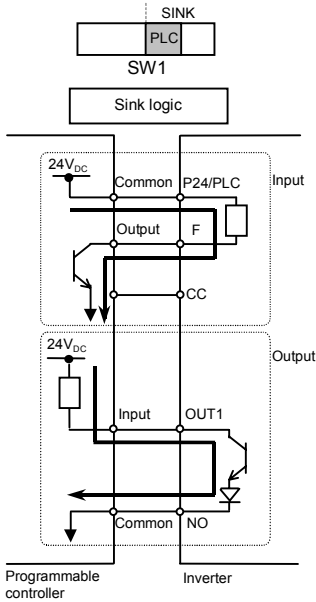

Note: Be sure to connect the 0V terminal on the external power supply to the CC terminal on the inverter.

*When OUT1 is used as a pulse output terminal (when SW4 is in the PULS position), the circuit shown below is always formed regardless of the logic selected (sink or source) and the power supply used (internal or external power supply).

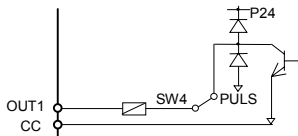

2

2.3.3 Serial RS485 communication connector

The VF-PS1 is equipped with two connectors: a two-wire RS485 connector (on the operation panel) and a four-wire RS485 connector. The two wire RS485 connector is used to connect an external option (such as remote keypad or computer) to the inverter. To connect to a network, use the four-wire RS485 connector, following the instructions below.

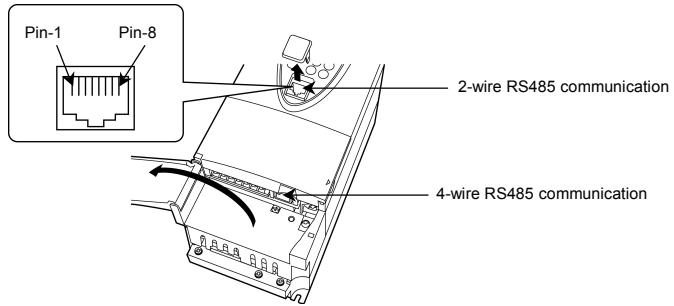

2-wire RS485

Signal name	Pin number	Description
DA	4	Same phase data
DB	5	Anti-phase data
SG	8	Ground line of signal data

This table shows signal line of inverter side.

* Never use pin-1, 2, 3, 6 and 7.

4-wire RS485

Signal name	Pin number	Description
RXA	4	Same phase reception data (positive line)
RXB	5	Anti-phase reception data (positive line)
TXA	3	Same phase transmitting data (positive line)
TXB	6	Anti-phase transmitting data (positive line)
SG	2, 8	Ground line of signal data

This table shows signal line of inverter side.

(Example: RXA signal is received by inverter.)

* Never use pin-1 (P24) and pin-7 (P11).

■ Connecting diagram for 4-wire RS485 communication

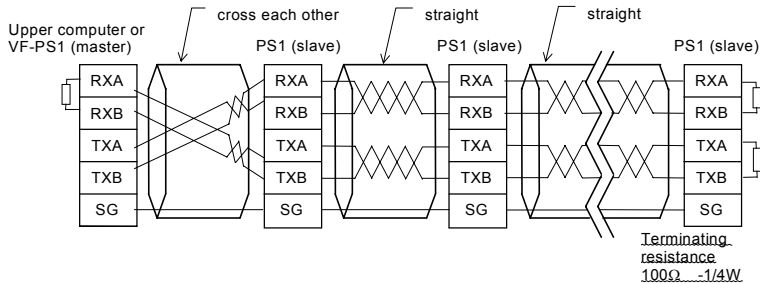

■ Note

- * Separate the communication line and the main circuit wiring by 20cm or more.
- * Never use pin-1 (P24) and pin-7 (P11).
- * Connect RXA and RXB, between TXA and TXB using twisted pair cable.
- * Connect terminating resistances at both ends of a transmission line.
- * When using 2-wire type, short RXB to TXB and RXA to TXA.

When connecting a communications device via the two-wire connector, carefully read the precautions for use in the operating manual for the communications device.



- * When connecting the VF-PS1 to other inverters, you do not need to connect the master receive lines (pins 4 and 5) or the slave send lines (pins 3 and 6).



3. Operations

This section explains the basics of operation of the inverter.

Check the following again before starting operation.

- 1) Are all wires and cables connected correctly?
- 2) Does the supply voltage agree with the rated input voltage?

 Danger	
 Prohibited	<ul style="list-style-type: none"> • Do not touch inverter terminals when electrical power is applied to the inverter even if the motor is stopped. Touching the inverter terminals while power is connected to it may result in electric shock. • Do not touch switches when the hands are wet and do not try to clean the inverter with a damp cloth. Such practices may result in electric shock. • Do not go near the motor in alarm-stop status when the retry function is selected. The motor may suddenly restart and that could result in injury. Take measures for safety, e.g. attaching a cover to the motor, against accidents when the motor unexpectedly restarts.
 Mandatory	<ul style="list-style-type: none"> • Turn power on only after attaching the front cover or closing door if enclosed in a cabinet. If power is turned on without the front cover attached or closing door may result in electric shock or other injury. • If the inverter begins to emit smoke or an unusual odor, or unusual sounds, immediately turn power off. If the equipment is continued in operation in such a state, the result may be fire. Call your local sales agency for repairs. • Always turn power off if the inverter is not used for long periods of time. • Do not turn on the power before attaching the front cover. When enclosed inside a cabinet and using with the front cover removed, always close the cabinet doors first and then turn power on. If the power is turned on with the front cover or with the cabinet doors open, it may result in electric shock. • Make sure that operation signals are off before resetting the inverter after malfunction. If the inverter is reset before turning off the operating signal, the motor may restart suddenly causing injury.

 Caution	
 Prohibited contact	<ul style="list-style-type: none"> • Do not touch heat radiating fins or discharge resistors. These devices are hot, and you'll get burned if you touch them.
 Prohibited	<ul style="list-style-type: none"> • Observe all permissible operating ranges of motors and mechanical equipment. (Refer to the motor's instruction manual.) Not observing these ranges may result in injury.

3.1 Setting/monitor modes

The VF-PS1 has the following three setting/monitor modes.

Standard monitor mode

The standard inverter mode. This mode is enabled when inverter power goes on.

This mode is for monitoring the output frequency and setting the frequency reference value. It also displays information about status alarms during running and trips.

- Setting frequency reference values ⇒ Refer to Section 3.2.2.
- Status alarm

If there is an error in the inverter, the alarm signal and the frequency will flash alternately in the LED display.

- \mathcal{L} : When a current flows at or higher than the overcurrent stall prevention level.
- P : When a voltage is generated at or higher than the over voltage stall prevention level.
- \mathcal{L} : When the cumulative amount of overload reaches 50% or more of the overload trip value.
- H : When temperature inside the inverter rises above overheating protection alarm level (about 95°C)

Setting monitor mode

The mode for setting inverter parameters.

⇒ How to set parameters, refer to Section 4. 1.

This mode is divided into two modes according to the parameter readout mode selected.

Quick mode :Eight frequently used basic parameters are just displayed.
The maximum 32 parameters that you select by yourselves are displayed.

Standard setting mode :Both basic and extended all parameters are displayed.

Status monitor mode

The mode for monitoring all inverter status.

Allows monitoring of set frequencies, output current/voltage and terminal information.

⇒ Refer to Section 8.

Pressing the key  will move the inverter through each of the modes.

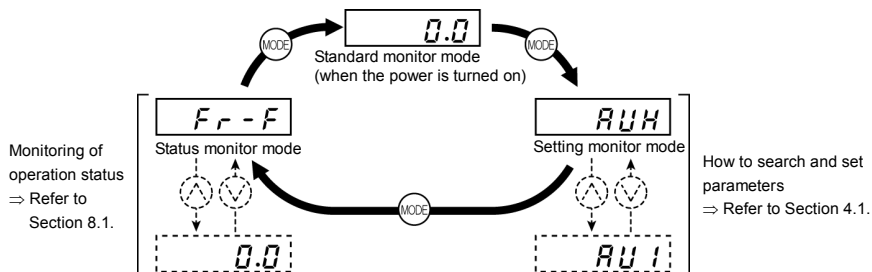

3.2 Simplified operation of the VF-PS1

On of three operation modes can be selected: terminal board operation, operation panel and combination of both.
 ⇒ For other operation modes, refer to Section 5.5.

Terminal board mode : Operation by means of external signals

Operation panel mode : Operation by pressing keys on the operation panel

Operation panel + terminal board mode : Frequency, start/stop signals can be sent individually from the operating panel and terminal board.

3.2.1 Terminal board operation

In this mode, the motor is started or stopped according to the ON/OFF signal to input terminals (such as the S3 terminal and the F terminal). Also, the frequency is set according to the potentiometer/voltage/current signals to analog input terminals (such as the RR/S4 terminal, VI/II terminal and RX terminal).
 ⇒ For more details, refer to Section 7.

Example of standard connection

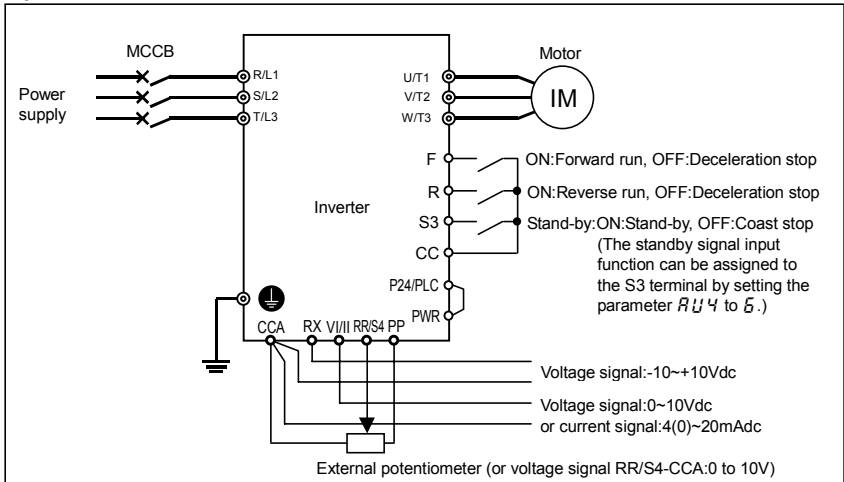

Run/Deceleration stop Selecting a command mode for basic parameters $\overline{C} \overline{N} \overline{O} \overline{d} = \overline{0}$ (standard default setting)

F and **CC** are connected: Forward run
F and **CC** are disconnected: Deceleration stop
 (When terminals **PWR** and **P24/PLC** are electrically connected)

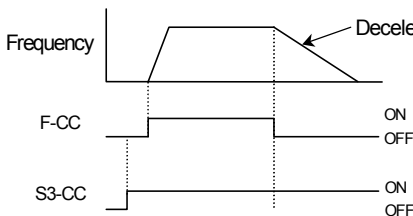

★For coast stop
 Open the connection between S3 and CC when stopping the motor in the state described at left. The monitor on the inverter at this time will display $\overline{0} \overline{F} \overline{F}$.

■ Frequency setting

1) Setting the frequency using potentiometer

★Potentiometer
The operation frequency by potentiometer (1~10kΩ- 1/4W) for setting
⇒ Refer to Section 7.3 for details of adjustment.

[Parameter setting]

Set the “basic parameter frequency setting mode selection 1” parameter F_{NOd} to 2.

(There is no need to set this parameter before the first use after purchase.)

2) Setting the frequency using input voltage (0~10V)

★Voltage signal
Voltage signal (0~10V) for setting the operation frequency
⇒ Refer to Section 7.3 for details of adjustment.

[Parameter setting]

Set the “basic parameter frequency setting mode selection 1” parameter F_{NOd} to 2.

(There is no need to set this parameter before the first use after purchase.)

3) Setting the frequency using current input (4(0)~20mA)

★Current signal
Current signal (4(0)~20mA) for setting the operation frequency
⇒ Refer to Section 7.3 for details of adjustment.

[Parameter setting]

Set the “extended parameter analog input VI/II voltage/current switching” parameter F_{NOd} to 1.
In addition, set the “basic parameter frequency setting mode selection 1” parameter F_{IOB} to 1.
To bring the operation frequency to 0Hz at an input current of 4mA, set the “VI/II input point setting 1” parameter F_{ZO1} to 20.

4) Setting the frequency using input voltage (0~10Vdc)

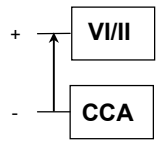

:Voltage signal 0-10Vdc

★Voltage signal
Voltage signal (0~10V) for setting the operation frequency
⇒ Refer to Section 7.3 for details of adjustment.

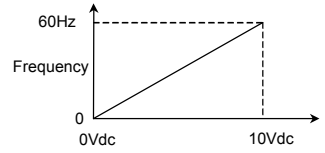

[Parameter setting]

Set the “extended parameter analog input VI/II voltage/current switching” parameter *FNOd* to *1*.
In addition, set the “basic parameter frequency setting mode selection 1” parameter *F108* to *0* (default setting).

3

5) Setting the frequency using input voltage (0~±10Vdc)

The direction can be changed by switching between positive and negative signals.

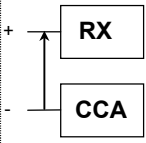

:Voltage signal 0~±10Vdc

★Voltage signal
Voltage signal (0~±10V) for setting the operation frequency
⇒ Refer to Section 7.3 for details of adjustment.

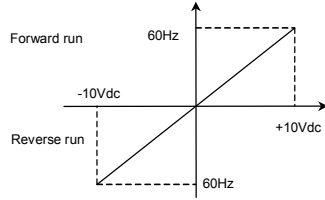















[Parameter setting]

Set the “basic parameter frequency setting mode selection 1” parameter *FNOd* to *3*.

Note: Set reference frequency priority selection *F200* to *0* (*FNOd*/*F200* terminal switching, default setting).
Changing the settings of two speed command parameters at a time, refer to Section 6.6.

[Example of setting: To set the frequency by applying a current of 4(0)~20mAdc via the VI/II terminal.]

Key operated	LED display	Operation
	0.0	Displays the operation frequency. (Perform during operation stopped.) (When standard monitor display selection <i>F710</i> = <i>0</i> [Output frequency])
MODE	RUK	Displays the first basic parameter “History function (RUK).”
▲ ▼	FNOd	Press either the ▲ or ▼ key to select “FNOd.”
ENT	2	Press the ENTER key to display the parameter setting (Default setting: 2).
▼	1	Press the ▼ key to change the parameter to 1.
ENT	1↔FNOd	Press the ENTER key to save the changed parameter. FNOd and the parameter are displayed alternately.

Key operated	LED display	Operation
 	<i>F 1--</i>	Press either the Δ key or the ∇ key to change to the parameter group <i>F 1--</i> .
	<i>F 100</i>	Press the ENTER key to display the first extended parameter <i>F 100</i> .
	<i>F 108</i>	Press the Δ key to change to <i>F 108</i> .
	<i>0</i>	Pressing the ENTER key allows the reading of parameter setting. (Default setting: <i>0</i>)
	<i>1</i>	Press the Δ key to change the parameter to <i>1</i> .
	<i>1\leftrightarrowF 108</i>	Press the ENTER key to save the changed parameter. <i>F 108</i> and the parameter are displayed alternately.
 	<i>F 2--</i>	Press either the Δ key or the ∇ key to change to the parameter group <i>F 2--</i> .
	<i>F 200</i>	Press the ENTER key to display the first extended parameter <i>F 200</i> .
	<i>F 201</i>	Press the Δ key to change to <i>F 201</i> .
	<i>0</i>	Pressing the ENTER key allows the reading of parameter setting. (Default setting: <i>0</i>)
	<i>20</i>	Press the Δ key to change the parameter to <i>20</i> .
	<i>20\leftrightarrowF 201</i>	Press the ENTER key to save the changed parameter. <i>F 201</i> and the parameter are displayed alternately.

3.2.2 Panel operation

This section describes how to start/stop the motor, and set the operation frequency with the operating panel.

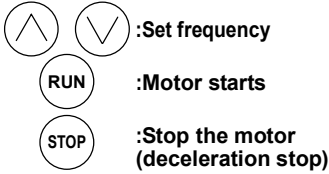

★For coast stop
Change the setting of the parameter $F72i$.

★The operation frequency can be changed anytime even during operation.

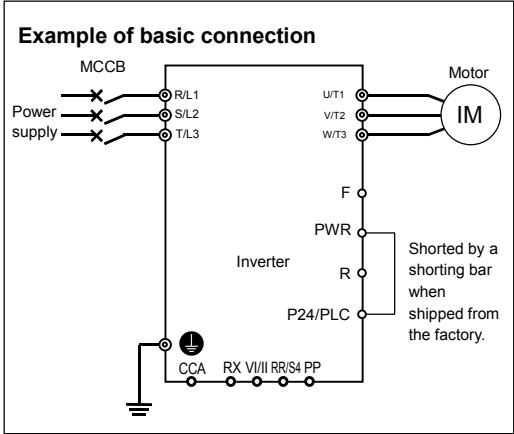

3

Changing parameter settings







For control panel operation, parameter settings need to be changed in advance.
If you use parameter $RU4$ that makes it possible to select an operation mode in one operation, you can complete this operation by just making settings once.
Here are the steps to be followed to change the setting to 5 (frequency setting and operation by means of the control panel).

[Setting procedure]

Key operated	LED display	Operation
	0.0	Displays the operation frequency (operation stopped). (When standard monitor display selection $F71i=0$ [Output frequency])
EASY		Press the EASY key.
MODE	$RU4$	$RU4$ (automatic function setting) at the head of the basic parameters available in quick mode is displayed.
ENT	0	Press the ENTER key to display the parameter setting (Default setting: 0).
Up Arrow	5	Press the Δ key to change the parameter to 5 (Frequency setting and operation on operation panel).
ENT	$5 \leftrightarrow RU4$	Press the ENTER key to save the changed parameter. $RU4$ and the parameter are displayed alternately.

*Pressing the MODE key returns the display to standard monitor mode (displaying operation frequency).

■ Example of operation panel control

Key operated	LED display	Operation
	0.0	The running frequency is displayed. (When standard monitor display selection $F 7 10=0$ [Output frequency])
 	50.0	Set the operation frequency.
	50.0 \Rightarrow F C	Press the ENTER key to save the operation frequency. F C and the frequency are displayed alternately.
	0.0 \Rightarrow 50.0	Pressing the RUN key causes the motor to accelerate to the set frequency in the specified acceleration time.
 	$\delta=0$	Pressing the Δ key or the ∇ key will change the operation frequency even during operation.
	50.0 \Rightarrow 0.0	Pressing the STOP key reduces the frequency and causes the motor to decelerate to a stop.

■ Selecting a stop mode with the operation panel

In addition to deceleration stop by pressing  key (in the specified deceleration time), the operating panel has the following two stop modes.

Stop mode	Action	Operation, setting, etc.
Coast stop	In this mode, power supply from the inverter to the motor is shut off instantaneously, which causes the motor to coast stop.	This stop mode is enabled only in modes where the operation panel can be used for operation. To enable the coast stop mode, set the parameter $F 7 2 1=1$. \Rightarrow For more details, refer to Section 6.31.5. *Default setting: $F 7 2 1=0$ (Deceleration stop)
Emergency stop (from the operation panel in modes other than the panel operation mode)	A stop mode can be selected from among: • Coast stop • Deceleration stop • Emergency DC braking Note: Default setting: $F 5 0 3=0$ (Coast stop)	In modes other than the operation panel operation mode, you can stop the motor (emergency stop) by entering a command from the operation panel. (To quickly stop the motor in the operation panel operation mode, set the parameter $F 7 2 1$ to this mode.) Pressing the STOP key on the panel twice enables emergency stop. (1) Press the STOP key. "E O F F" starts blinking. (2) Press the STOP key again. $F 5 0 3$ (Emergency stop)=0 to 2, the motor makes an emergency stop (or trips) according to the setting. "E" will be displayed and a failure detection signal generated (FL activated). Select the output terminal function 134 (135) to deactivate FL. To clear "E O F F," press any key other than the STOP key while "E O F F" is being displayed. \Rightarrow For more details, refer to Section 6.26.3. *Default setting: $F 5 0 3=0$ (Coast stop) - Caution - The emergency stop function is designed to forcefully stop the motor by pressing the Stop key on the operation panel in modes other than the operation panel control mode. The emergency stop function cannot be disabled by any setting. Every emergency stop is memorized as a trip in the trip history record.

4. Searching and setting parameters

There are two types of setting mode quick mode and standard setting mode.

Quick mode

: EASY key: ON
 Eight frequently used basic parameters are just displayed (Factory default position).

Quick mode (EASY)

Title	Function
<i>RU4</i>	Automatic function setting
<i>Pt</i>	V/f control mode selection
<i>FH</i>	Maximum frequency
<i>RLC</i>	Acceleration time 1
<i>dEL</i>	Deceleration time 1
<i>tHr</i>	Motor electronic thermal protection level 1
<i>FΩ</i>	FM terminal meter adjustment
<i>PSEL</i>	Registered parameter display selection

Parameters you selected can be displayed by changing the parameter. (Up to 32 parameters)

4

Standard setting mode

: EASY key: OFF
 Both basic and extended all parameters are displayed.

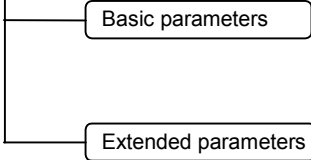

: This parameter is a basic parameter for the operation of the inverter.
 => For details of basic parameters, refer to Section 5.
 => For parameter settings, refer to Section 11.

: The parameters for detailed and special setting.
 => For details of extended parameters, refer to Section 6.
 => For parameter settings, refer to Section 11.

For reasons of safety, the following parameters have been set up so that they cannot be reprogrammed while the inverter is running.

- [Basic parameters]
- RU1* (Automatic acceleration/deceleration)
 - RU2* (Automatic torque boost)
 - RU4* (Automatic function setting)
 - CRd* (Command mode selection)
 - FRd* (Frequency setting mode selection 1)
 - Pt* (V/f control mode selection)
 - uL* (Base frequency 1)
 - uLv* (Base frequency voltage 1)
 - FH* (Maximum frequency)
 - Uu5* (Auto-restart control selection)
 - UuL* (Regenerative power ride-through control)
 - Pb* (Dynamic braking selection)
 - Pbr* (Dynamic braking resistance)
 - PbCP* (Allowable continuous braking resistance)
 - tYP* (Factory default setting)

=> To write-protect extended parameters during operation, refer to Section 11.

4.1 How to set parameters

This section explains how to set parameters, while showing how parameters are organized in each setting monitor mode.

4.1.1 Setting parameters in the selected quick mode

To place the inverter in this mode, press the **(EASY)** key (the LED lights up), and then press the **(MODE)** key.

Note that extended parameters are not displayed in the quick mode.

Quick mode (EASY)

Title	Function
<i>RU4</i>	Automatic function setting
<i>Pt</i>	V/f control mode selection
<i>FH</i>	Maximum frequency
<i>ACC</i>	Acceleration time 1
<i>dEC</i>	Deceleration time 1
<i>tHr</i>	Motor electronic thermal protection level 1
<i>FN</i>	FM terminal meter adjustment
<i>PSEL</i>	Registered parameter display selection

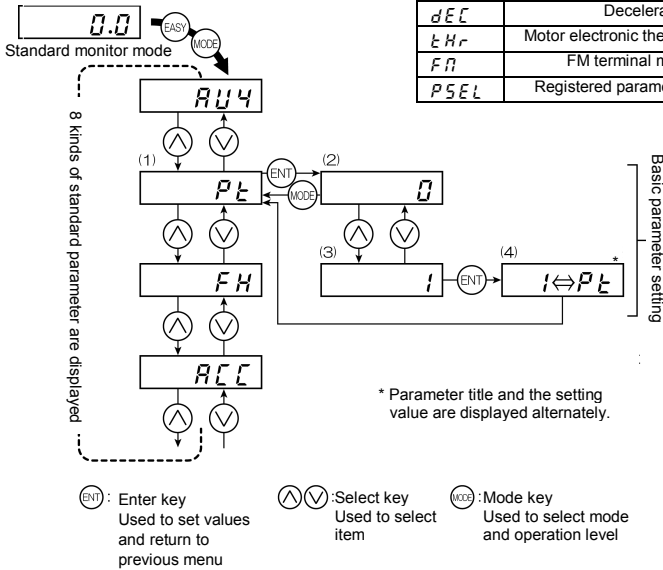

■ How to set basic parameters

- (1) Selects parameter to be changed. (Press the **(▲)** or **(▼)** key.)
- (2) Reads the programmed parameter setting. (Press the **(ENT)** key.)
- (3) Change the parameter value. (Press the **(▲)** or **(▼)** key.)
- (4) Press this key to save the change. (Press the **(ENT)** key.)

■ Adjustment range and display of parameters

H : An attempt has been made to assign a value that is higher than the programmable range. Or, as a result of changing other parameters, the programmed value of the parameter that is now selected exceeds the upper limit.

L : An attempt has been made to assign a value that is lower than the programmable range. Or, as a result of changing other parameters, the programmed value of the parameter that is now selected exceeds the lower limit.

If the above alarm is flashing on and off, no setting can be done of values that are equal to or greater than **H** or equal to or lower than **L**.

4.1.2 Setting parameters in the standard setting mode

Press the **MODE** key to place the inverter in this mode.

■ How to set basic parameters

- (1) Selects parameter to be changed. (Press the **▲** or **▼** key.)
- (2) Reads the programmed parameter setting. (Press the **ENT** key.)
- (3) Change the parameter value. (Press the **▲** or **▼** key.)
- (4) Press this key to save the change. (Press the **ENT** key.)

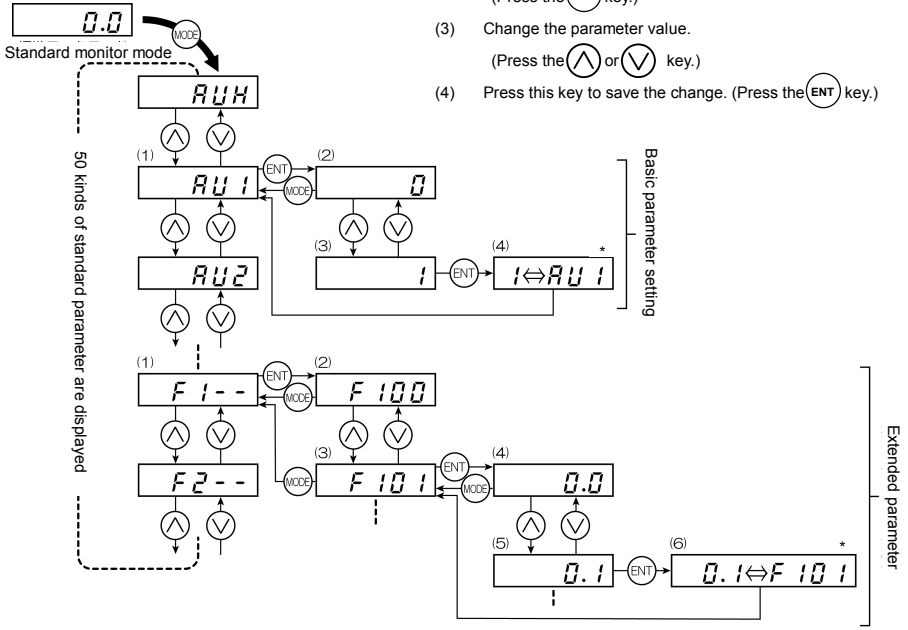

ENT: Enter key
Used to set values and return to previous menu

▲▼: Select key
Used to select item

MODE: Mode key
Used to select mode and operation level

* Parameter title and the setting value are displayed alternately.

■ How to set extended parameters

Each extended parameter is composed of an "F" and three figures that follow the f, so first select and read out the heading of the parameter you want "F 1 - - ~ "F 9 - - ." ("F 1 - -":Parameter bearing a number between 100 and 199, "F 9 - -":Parameter bearing a number between 900 and 999)

- (1) Select the title of the parameter you want to change. (Press the **▲** or **▼** key.)
- (2) Press the Enter key to activate the selected parameter. (Press the **ENT** key.)
- (3) Selects parameter to be changed. (Press the **▲** or **▼** key.)
- (4) Reads the programmed parameter setting. (Press the **ENT** key.)
- (5) Change the parameter value. (Press the **▲** or **▼** key.)
- (6) Press this key to save the change. (Press the **ENT** key.)

■ Adjustment range and display of parameters

H I: An attempt has been made to assign a value that is higher than the programmable range. Or, as a result of changing other parameters, the programmed value of the parameter that is now selected exceeds the upper limit.

L O: An attempt has been made to assign a value that is lower than the programmable range. Or, as a result of changing other parameters, the programmed value of the parameter that is now selected exceeds the lower limit.

If the above alarm is flashing on and off, no setting can be done of values that are equal to or greater than **H I** or equal to or lower than **L O**.

4.2 Functions useful in searching for a parameter or changing a parameter setting

This section explains functions useful in searching for a parameter or changing a parameter setting. To use these functions, a parameter needs to be selected or set in advance.

Changed parameter search function

Automatically searches for only those parameters that are programmed with values different from the standard default setting. To use this function, select the **CUU** parameter.

⇒ For more details, refer to Section 5.21.

Parameter change history function

Automatically searches for the last five parameters that have been set to values different from their standard default values. To use this function, select the **RUH** parameter.

⇒ For more details, refer to Section 5.1.

Function of resetting all parameters to their default settings

Use the **Y P** parameter to reset all parameters back to their default settings.

⇒ For more details, refer to Section 5.20.

5. Basic parameters

This parameter is a basic parameter for the operation of the inverter.
 ⇒ Refer to Section 11, Table of parameters.













5.1 History function

RUH : History function

• **Function**
 Automatically searches for 5 latest parameters that are programmed with values different from the standard default setting and displays them in the *RUH*. Parameter setting can also be changed within this group *RUH*.
 This function comes in very handy when you adjust the inverter repeatedly using the same parameter.

Note 1: If no history information is stored, this parameter is skipped and the next parameter *RU1*.
 Note 2: *HERd* and *ENd* are added respectively to the first and last parameters in a history of changes.

[Setting methods]

Key operated	LED display	Operation
	0.0	Displays the operation frequency (operation stopped). (When standard monitor display selection <i>F710=0</i> (Output frequency))
	<i>RUH</i>	The first basic parameter "History function (<i>RUH</i>)" is displayed.
	<i>RCC</i>	The parameter that was set or changed last is displayed.
	8.0	Press the ENTER key to display the set value.
 	5.0	Press the Δ key and ∇ key to change set value.
	5.0 \leftrightarrow <i>RCC</i>	Press the ENTER key to save the changed value. The parameter name and the programmed value will flash on and off alternately.
 ()	****	Use the same steps as those given above to display parameters that you want to search for or change setting with the Δ key and ∇ key.
 ()	<i>HERd</i> (<i>ENd</i>)	<i>HERd</i> : First historic record <i>ENd</i> : Last historic record
  	Parameter display ↓ <i>RUH</i> ↓ <i>F_r-F</i> ↓ 0.0	Press the MODE key to return to the parameter setting mode <i>RUH</i> . After that you can press the MODE key to return to the status monitor mode or the standard monitor mode (display of operation frequency).

5.2 Setting acceleration/deceleration time

$RU1$: Automatic acceleration/deceleration

ACC : Acceleration time 1

DEC : Deceleration time 1

• Function

- 1) For acceleration time 1 ACC programs the time that it takes for the inverter output frequency to go from 0Hz to maximum frequency FH .
- 2) For deceleration time 1 DEC programs the time that it takes for the inverter output frequency to go from maximum frequency FH to 0Hz.

5.2.1 Automatic acceleration/deceleration

This automatically adjusts acceleration and deceleration time in line with load size.

$RU1 = 1$

* Adjusts the acceleration/deceleration time automatically within the range of 1/8 to 8 times as long as the time set with the ACC or DEC , depending on the current rating of the inverter.

$RU1 = 2$

* Automatically adjusts speed during acceleration only. During deceleration, speed is not adjusted automatically but reduced at the rate set with DEC .

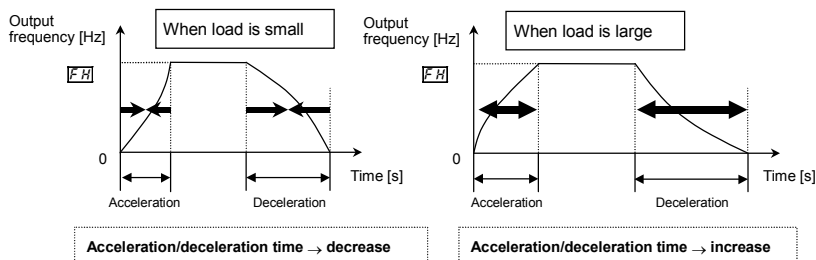

Set $RU1$ (automatic acceleration/deceleration) to 1 or 2.

[Parameter setting]

Title	Function	Adjustment range	Default setting
$RU1$	Automatic acceleration/deceleration	0: Disabled (Manual setting) 1: Automatic setting 2: Automatic setting (during acceleration only)	0

★ When automatically setting acceleration/deceleration time, always change the acceleration/deceleration time so that it conforms with the load.

The acceleration/deceleration time changes constantly with load fluctuations.

For inverters that requires a fixed acceleration/deceleration time, use the manual settings (ACC , DEC).

★ When using a braking resistor or braking unit, do not set the $RU1 = 1$. Or the regenerative braking resistor may be overloaded.

★ Use this parameter after actually connecting the motor.

★ Setting acceleration/deceleration time (ACC , DEC) in conformance with mean load allows optimum setting that conforms to further changes in load.

★ When the inverter is used with a load that fluctuates considerably, it may fail to adjust the acceleration or deceleration time in time, and therefore may be tripped.

5.2.2 Manually setting acceleration/deceleration time

Set acceleration time from 0 (Hz) operation frequency to maximum frequency FH and deceleration time as the time when operation frequency goes from maximum frequency FH to 0 (Hz).

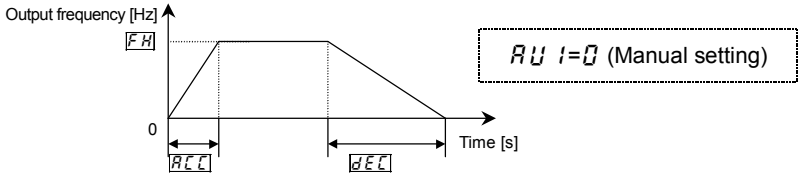

[Parameter setting]

Title	Function	Adjustment range	Default setting
RLL	Acceleration time 1	0.1[Note]~6000 sec.	According to model ⇒ Refer to page K-41.
dEL	Deceleration time 1	0.1[Note]~6000 sec.	According to model ⇒ Refer to page K-41.

Note: The minimum setting of acceleration and deceleration times have been set respectively at 0.1 sec. by default, but they can be changed within a range of 0.01 sec. (setting range:0.01~600.0 sec.) by changing the setting of the parameter τ YP (default setting).
⇒ For details, refer to Section 5.20.

★ If the programmed value is shorter than the optimum acceleration/deceleration time determined by load conditions, overcurrent stall or overvoltage stall function may make the acceleration/deceleration time longer than the programmed time. If an even shorter acceleration/deceleration time is programmed, there may be an overcurrent trip or overvoltage trip for inverter protection.
⇒ For details, refer to Section 13.1.

5.3 Increasing starting torque

RU2 : Automatic torque boost

• Function

Simultaneously switches inverter output V/f control and programs motor constants automatically (auto-tuning function 1) to improve torque generated by the motor. This parameter integrates the setting of special V/f control selection such as automatic torque boost or vector control.

- Constant torque characteristics (default setting)
- **Automatic torque boost+auto-tuning 1**
- **Sensorless vector control+auto-tuning 1**

Note: Square reduction torque control, sensor vector control (optional), etc. can be selected using the V/f control mode selection parameter PL.

⇒ For details, refer to Section 5.6.

[Parameter setting]

Title	Function	Adjustment range	Default setting
RU2	Automatic torque boost	0: Disabled (Always 0 is displayed.) 1: Automatic torque boost+auto-tuning 1 2: Sensorless vector control+auto-tuning 1	0

Note: Parameter displays on the right always return to 0 after resetting. The previous setting is displayed on the left.

Ex. 10

1) Increasing torque automatically according to the load

Set the automatic torque boost $RU2=1$ (automatic torque boost+auto-tuning 1)

Automatic torque boost $RU2=1$ detects load current in all speed ranges and automatically adjusts voltage output from inverter. This gives steady torque for stable runs.

Note 1: The same characteristic can be obtained by setting the V/f control mode selection parameter Pt to 2 (automatic torque boost) and $F400$ (auto-tuning 1) to 2. ⇒ Refer to Section 6.19.

Note 2: Setting $RU2$ to 1 automatically programs Pt to 2.

Note 3: If stable operation cannot be achieved with this setting, set the parameters uL (base frequency), $uL u$ (base-frequency voltage), $F405$ (rated capacity of motor), $F406$ (rated current of motor) and $F407$ (rated number of revolutions of motor) as specified on the motor nameplate, and then set $F400$ to 4 and $RU2$ to 1 again.

2) When using vector control (increasing starting torque and high-precision operations)

Set the automatic torque boost $RU2=2$ (sensorless vector control+auto-tuning 1)

Setting automatic torque boost $RU2=2$ (Sensorless vector control+auto-tuning 1) provides high starting torque bringing out the maximum in motor characteristics from the low-speed range. This suppresses changes in motor speed caused by fluctuations in load to provide high precision operation. This setting is most suitable for transfer and lifting systems that are operated in speed control mode.

Note 1: The same characteristic can be obtained by setting the V/f control mode selection parameter Pt to 3 (Sensorless vector control) and $F400$ (Auto-tuning 1) to 2. ⇒ Refer to Section 6.19.

Note 2: Setting $RU2$ to 2 automatically programs Pt to 3.

Note 3: If stable operation cannot be achieved with this setting, set the parameters uL (base frequency), $uL u$ (base-frequency voltage), $F405$ (rated capacity of motor), $F406$ (rated current of motor) and $F407$ (rated number of revolutions of motor) as specified on the motor nameplate, and then set $F400$ to 4 and $RU2$ to 2 again.

If vector control cannot be programmed....

First read the precautions about vector control in 5.6, 10).

1) If the desired torque cannot be obtained ⇒ Refer to 6.19 selection 3.

2) If auto-tuning error "E t n" appears ⇒ Refer to 13.1 and 6.19 selection 3.

■ $RU2$ (automatic torque boost) and Pt (V/f control mode selection)

Automatic torque boost is the parameter for setting V/f control mode selection (Pt) and auto-tuning 1 ($F400$) together. That is why all parameters related to change automatically when $RU2$ is changed.

$RU2$		Automatically programmed parameters	
		Pt	$F400$
0	Disabled (Always 0 is displayed.)	-	-
1	Automatic torque boost+auto-tuning 1	2	2: Executed (0 after execution)
2	Sensorless vector control+auto-tuning 1	3	2: Executed (0 after execution)

3) Increasing torque manually (V/f constant control)

The VF-PS1 inverter is set to this control mode by factory default.

This is the setting of constant torque characteristics that are suited for such things as conveyors. It can also be used to manually increase starting torque.

To return to V/f constant control after changing the $RU2$ setting:

Set the V/f control mode selection parameter $Pt=0$ (constant torque characteristic).

⇒ Refer to Section 5.6.

Note: If you want to increase torque further, raise the setting value of manual torque boost $u b$.

How to set manual torque boost parameter $u b$

⇒ Refer to Section 5.7.

5.4 Setting parameters by operating method

RU4 : Automatic function setting

• **Function**
 Automatically programs all parameters (parameters described below) related to the functions by selecting the inverter's operating method.
 The major functions can be programmed simply.

[Parameter setting]

Title	Function	Adjustment range	Default setting
RU4	Automatic function setting	0: Disabled 1: Frequency setting by means of voltage 2: Frequency setting by means of current 3: Voltage/current switching from external terminal 4: Frequency setting on operation panel and operation by means of terminal 5: Frequency setting and operation on operation panel 6: Coast stop	0

Automatically programmed functions and parameter set values

	Default setting	0: Disabled	1: Frequency setting by means of voltage	2: Frequency setting by means of current	3: Voltage/current switching from external terminal	4: Frequency setting on operation panel and operation by means of terminal	5: Frequency setting and operation on operation panel	6: Coast stop
C00d	0: Terminal board	-	-	-	-	0: Terminal board	1: Operation panel	-
F00d	2: RR/S4	-	2: RR/S4	1: VI/II	2: RR/S4	4: Operation panel	4: Operation panel	-
F10B	0: Voltage input	-	-	1: Current input	1: Current input	-	-	-
F110	5: Standby	-	-	-	-	-	-	0: No function is assigned
F117 (S3)	14: Preset speed command 3	-	-	-	104: Frequency priority switching	-	-	5: Standby
F200	0: F00d / F207 terminal switching	-	0: F00d / F207 terminal switching	0: F00d / F207 terminal switching	0: F00d / F207 terminal switching	0: F00d / F207 terminal switching	0: F00d / F207 terminal switching	-
F201	0%	-	-	20%	20%	-	-	-
F207	1: VI/II	-	2: RR/S4	1: VI/II	1: VI/II	4: Operation panel	4: Operation panel	-

⇒ Refer to Section 11 for input terminal functions.

Disabled (RU4=0)

No change is made to the parameter setting.

Frequency setting by means of voltage: (RU4=1)

Operation is performed by applying a voltage for setting the RR/S4 terminal 1 frequency.

When sink logic is selected:

PWR-P24/PLC ON: Standby (ON (short-circuited) by default)

F-CC ON: Forward run

R-CC ON: Reverse run

Frequency setting by means of current (RU4=2)

This setting is used to set the frequency by applying a current of 4-20mA to the VI/II terminal.

PWR-P24/PLC ON: Standby (ON (short-circuited) by default)

F-CC ON: Forward run

R-CC ON: Reverse run

Voltage/current switching by means of an external terminal (RU4=3)

Switching between remote and local (different frequency commands) can be performed by turning on or off the S3 terminal. In that case, apply a voltage via the RR/S4 terminal and a current via the VI/II terminal.

S3-CC OFF: The frequency is set according to the voltage applied to the RR/S4 terminal.

S3-CC ON: The frequency is set according to the current applied to the VI/II terminal.

In sink logic mode: PWR-P24/PLC ON: Standby (ON (short-circuited) by default), F-CC ON: Forward run, R-CC ON: Reverse run.

Frequency setting with operation panel and operation with terminal board (R U 4=4)

This setting is used to set the frequency using the operation panel and to perform operation control using the terminal board.



Use the  and  keys to set the frequency.

In sink logic mode: PWR-P24/PLC ON: Standby (ON (short-circuited) by default),
F-CC ON: Forward run, R-CC ON: Reverse run.

Frequency setting and operation with operation panel (R U 4=5)

This setting is used to set the frequency and to perform operation control, using the operation panel.

Use the  and  keys to set the frequency.

Use the  and  keys to perform operation control.

Coast stop (R U 4=6)

This setting is used to coast and stop the motor by means of an S3 terminal signal.

The frequency is adjusted according to the setting of the parameter $F n Q d$. The motor is operated in accordance with the setting of the parameter $C n Q d$.

If S3 and CC are short-circuited, the motor will be put into a standby state. If the circuit between S3 and CC is opened, the motor coasts and stops.

5.5 Selection of operation mode

$C n Q d$: Command mode selection

$F n Q d$: Frequency setting mode selection 1

• Function



These parameters are to program which command to the inverter (from operation panel, terminal board, remote input device or options) will be given priority in running/stopping the operation and in frequency setting (speed).

<Command mode selection>

[Parameter setting]

Title	Function	Adjustment range	Default setting
$C n Q d$	Command mode selection	0 : Terminal input enabled 1 : Operation panel input enabled (including LED/LCD option input) 2 : 2-wire RS485 communication input 3 : 4-wire RS485 communication input 4 : Communication option input	0

[Programmed value]

- 0 : **Terminal board operation** ON and OFF of an external signal Runs and stops operation.
- 1 : **Operation panel operation** Press the  and  keys on the operation panel to Run and stop a run. (including LED/LCD option input)
- 2 : **2-wire RS485 communication operation** Run and stop commands are entered from the 2-wire RS485 communications device. (Communication No.: FA00)
- 3 : **4-wire RS485 communication operation** Run and stop commands are entered from the 4-wire RS485 communications device. (Communication No.: FA04)
- 4 : **Communication option input enabled** Signals from an optional communication device are used to start and stop operation.
 => For details, refer to Instruction Manual (E6581281, E6581343, E6581288) specified in Section 6.36.

* There are two types of function: the function that conforms to commands selected by $C n Q d$, and the function that conforms only to commands from the terminal board.

=> Refer to the table of input terminal function selection in Section 7.2.



* When priority is given to commands from a linked computer or terminal board, they have priority over the setting of $C n Q d$.

<Frequency setting mode selection>

[Parameter setting]

Title	Function	Adjustment range	Default setting
<i>F n o d</i>	Frequency setting mode selection 1	1:VI/II (voltage/current input) 2:RR/S4 (potentiometer/voltage input) 3:RX (voltage input) 4:Operation panel input enabled (including LED/LCD option input) 5:2-wire RS485 communication input 6:4-wire RS485 communication input 7:Communication option input 8:Optional AI1 (differential current input) 9:Optional AI2 (voltage/current input) 10:Up/Down frequency 11:Optional RP pulse input 12:Optional high-speed pulse input	2

[Programmed value]

- 1: **VI/II input** Speed setting commands are entered by external signals (0~10Vdc or 4(0)~20mAdc).
- 2: **RR/S4 input** Speed setting commands are entered by external signals (RR/S4 terminal:0~10Vdc).
- 3: **RX input** Speed setting commands are entered by external signals (RX terminal:0~±10Vdc (±5Vdc)).
- 4: **Operation panel input** Press the  and  keys on the operation panel to set the frequency. (including LED/LCD option input)
- 5: **2-wire RS485 communication operation** Speed commands are entered from the 2-wire RS485 communications device. (Communication No.:FA01)
- 6: **4-wire RS485 communication operation** Speed commands are entered from the 4-wire RS485 communications device. (Communication No.:FA05)
- 7: **Communication option input enabled** Speed commands are entered from an optional communication device.
 ⇒ For details, refer to Instruction Manual (E6581281, E6581343, E6581288) specified in Section 6.36.
- 8: **AI1 input** Speed setting commands are entered by external signals (AI1 terminal (option): 0~±10Vdc (±5Vdc)).
- 9: **AI2 input** Speed setting commands are entered by external signals (AI2 terminal: 0~10Vdc or 4(0)~20mAdc) (optional).
- 10: **Up/Down frequency** Speed commands are entered by means of Up/Down frequency signals from the terminal board. ⇒ Refer to Section 7.2.
- 11: **RP pulse input** Speed commands are entered by means of RP pulses (optional).
- 12: **High-speed pulse input** Speed commands are entered by means of high-speed pulses (optional).

★The functions assigned to the following control input terminals (contact input: ⇒ Refer to Section 7.2) are always activated regardless of the settings of the command mode selection $\mathcal{C}M\mathcal{D}$ and frequency setting mode selection 1 $F\mathcal{M}\mathcal{D}$.

- Reset terminal (default setting: RES, valid only for tripping)
- Power removal terminal (assigned to PWR by default)
- Emergency stop terminal

★To make changes in the command mode selection $\mathcal{C}M\mathcal{D}$ and the frequency setting mode selection 1 $F\mathcal{M}\mathcal{D}$ first stop the inverter temporarily.

No change can be made to them if the inverter is in operation.

■ Preset speed operation

$\mathcal{C}M\mathcal{D}$: Set this parameter at 0 (terminal board).

$F\mathcal{M}\mathcal{D}$: Any setting is valid.

1) Setting the run, stop and operation frequencies with the operation panel

Title	Function	Example of setting
$\mathcal{C}M\mathcal{D}$	Command mode selection	1 (Operation panel input)
$F\mathcal{M}\mathcal{D}$	Frequency setting mode selection 1	4 (Operation panel input)

Run/stop: Press the RUN and STOP keys on the operation panel

★To switch between forward run and reverse run, use the forward/reverse run selection F_r .

Speed command: Press the ▲ and ▼ keys on the operation panel to set the frequency.

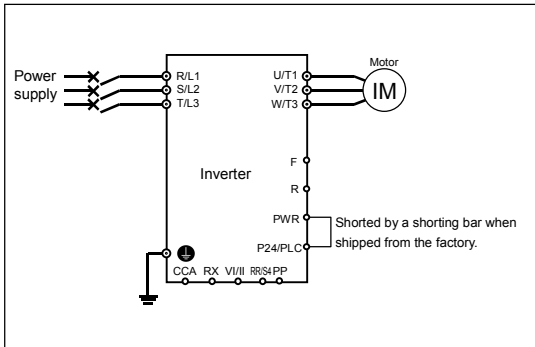



To save the frequency, press the ENTER key. Then, $F\mathcal{L}$ and the set frequency are displayed alternately for a while.

5

2) Setting the run and stop frequencies (forward run, reverse run and coast stop) by means of external signals and setting the operation frequency with the operation panel

Title	Function	Example of setting
<i>Command</i>	Command mode selection	<i>7</i> (Terminal input)
<i>Freq</i>	Frequency setting mode selection 1	<i>4</i> (Operation panel input)

Run/stop: ON/OFF of terminals F-CC/R-CC (Standby: connection of terminals PWR and P24/PLC)

Speed command: Set the frequency, using the   keys on the operation panel.

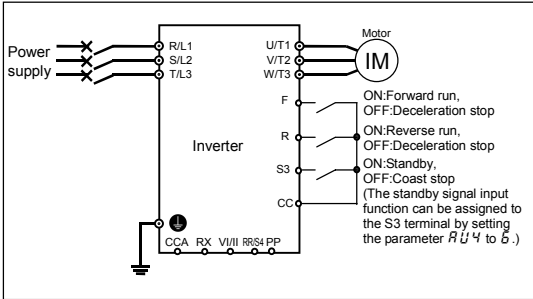

★ The inverter is factory-configured so that, if F and R are turned on at the same time, the inverter will stop operation. If necessary, the direction of rotation can be reversed by changing parameter settings.
⇒ Refer to Section 6.2.1.

★ To save the frequency, press the ENTER key. Then, *F* and the set frequency are displayed alternately for a while.

3) Setting the run and stop frequencies (forward run, reverse run and deceleration stop) with the operation panel and setting the operation frequency by means of external signals

Title	Function	Example of setting
<i>Command</i>	Command mode selection	<i>1</i> (Operation panel input)
<i>Freq</i>	Frequency setting mode selection 1	<i>1</i> (V/II (voltage/current input)) <i>2</i> (RR/S4 (potentiometer/voltage input)) <i>3</i> (RX (voltage input))

Run/stop: Press the  and  keys on the operation panel

★ To switch between forward run and reverse run, use the forward/reverse run selection *F_r*.

- Speed command:** External signal input
- (1) V/II terminal: 0~+10Vdc (0~+5Vdc) or 4(0)~20mAdc
 - (2) RR/S4 terminal: Potentiometer 0~+10Vdc (0~+5Vdc)
 - (3) RX terminal: 0~+10Vdc (0~+5Vdc)

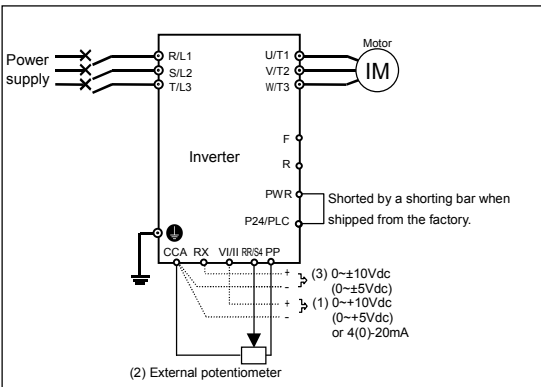

- * Other speed setting
- 5*: 2-wire RS485 input
 - 6*: 4-wire RS485 input enabled
 - 7*: Communication option input enabled *
 - 8*: Optional AI1 (differential current input) *
 - 9*: Optional AI2 (voltage/current input) *
 - i1*: Up/Down frequency
 - i2*: RP pulse input *
 - i3*: High-speed pulse input *

* Commands marked with * are optional. Refer to Instruction Manual of options described in Section 10.

4) Setting the run, stop and operation frequencies (forward run, reverse run and coast stop) by means of external signals (default setting)

Title	Function	Example of setting
<i>C n d</i>	Command mode selection	<i>Q</i> (Terminal input)
<i>F n d</i>	Frequency setting mode selection 1	<i>I</i> (VI/II (voltage/current input)) <i>Z</i> (RR/S4 (potentiometer/voltage input)) <i>3</i> (RX (voltage input))

Run/stop: ON/OFF of terminals F-CC/R-CC

Speed command: External signal input

- (1) VI/II terminal: 0~+10Vdc (0~+5Vdc) or 4(0)~20mAdc
- (2) RR/S4 terminal: Potentiometer 0~+10Vdc (0~+5Vdc)
- (3) RX terminal: 0~+10Vdc (0~+5Vdc)

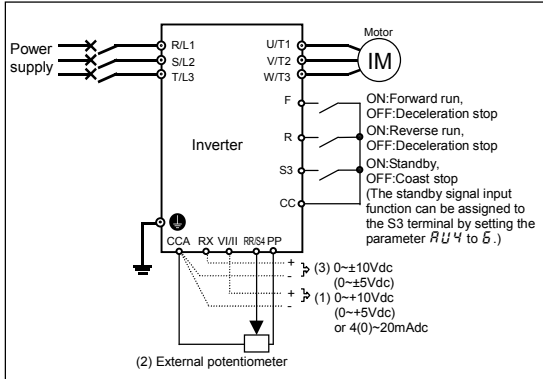

★ The inverter is factory-configured so that, if F and R are turned on at the same time, the inverter will stop operation. If necessary, the direction of rotation can be reversed by changing parameter settings. → Refer to Section 6.2.1.

- * Other speed setting
- 5*: 2-wire RS485 input
- 6*: 4-wire RS485 input enabled
- 7*: Communication option input enabled *
- 8*: Optional AI1 (Differential current input) *
- 9*: Optional AI2 (voltage/current input) *
- I Q*: Up/Down frequency
- I 1*: RP pulse input *
- I 2*: High-speed pulse input *

* Commands marked with * are optional. Refer to Instruction Manual of options described in Section 10.

5

5.6 Selecting control mode

P_t : V/f control mode selection

• **Function**
 With "VF-PS1," the V/f controls shown below can be selected.

- 0: Constant torque characteristics
- 1: Voltage decrease curve
- 2: Automatic torque boost (*1)
- 3: Sensorless vector control (*1)
- 5: V/f 5-point setting
- 6: PM control (*2)
- 7: PG feedback control (*3)
- 9: Energy-saving
- 10: Advanced energy-saving

(*1) "Automatic control" parameter automatically sets this parameter and auto-tuning 1 at a time.
 (*2) Use a dedicated motor with permanent magnets.
 (*3) A PG feedback device (optional) is needed for this control.

[Parameter setting]

Title	Function	Adjustment range	Default setting
P _t	V/f control mode selection	0: Constant torque characteristics 1: Voltage decrease curve 2: Automatic torque boost 3: Sensorless vector control 1 4: - (No operation) 5: V/f 5-point setting 6: PM control 7: PG feedback control 8: - (No operation) 9: Energy-saving 10: Advanced energy-saving	0

5

Caution

Mandatory

• When operating the inverter with P_t set to 2, 3 or 7 be sure to set the motor constant parameter correctly. Failure to do this may cause the inverter not to control the motor properly, and thus cause the motor not to deliver the desired performance. For more information, see the explanation of each P_t setting in the following sections.

1) Constant torque characteristics (Normal way of use)

Setting of V/f control mode selection P_t = 0 (Constant torque characteristics)

This is applied to loads with equipment like conveyors and cranes that require the same torque at low speeds as at rated speeds.

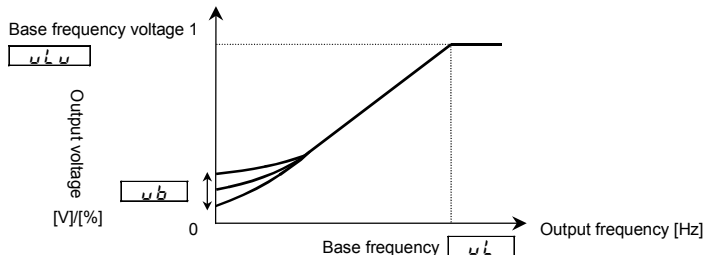

* To increase the torque further, increase the setting value of the manual torque boost parameter u_b .
 ⇒ For more details, refer to Section 5.7.

2) Decreasing output voltage

Setting of V/f control mode selection $P_{\tau} = 1$ (Voltage decrease curve)

This is appropriate for load characteristics of such things as fans, pumps and blowers in which the torque in relation to load rotation speed is proportional to its square.

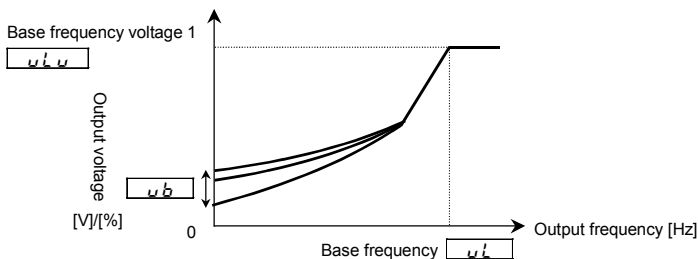

3) Increasing starting torque

Setting of V/f control mode selection $P_{\tau} = 2$ (Automatic torque boost)

Detects load current in all speed ranges and automatically adjusts voltage output (torque boost) from inverter. This gives steady torque for stable runs.

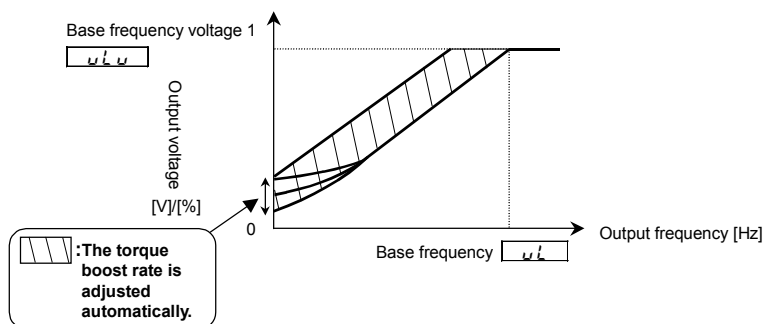

Note: This control system can oscillate and destabilize runs depending on the load. If that should happen, set V/f control mode selection P_{τ} to 0 (Constant torque characteristics) and increase torque manually.

★Motor constant must be set.

The motor constant can be set in any of the following two ways:

1) Automatic setting

Enter the following information that is indicated on the motor nameplate, and then execute the auto-tuning 1 command (Set F_{400} to 4, and then reset F_{400} to 2).

<Information indicated on motor nameplate>

ω_b (Base frequency), $\omega_b \omega$ (Base frequency voltage), F_{405} (Motor rated capacity), F_{406} (Motor rated current), F_{407} (Motor rated rotational speed)

⇒ Refer to 6.22 selection 2.

2) Manual setting

Set each motor constant manually.

⇒ Refer to 6.22 selection 3.

4) Vector control—increasing starting torque and achieving high-precision operation.

Setting of V/f control mode selection $P_{\text{L}} = 3$ (Sensorless vector control)

Using sensorless vector control with a Toshiba standard motor will provide the highest torque at the lowest speed ranges. The effects obtained through the use of sensorless vector control are described below.

- (1) Provides large starting torque.
- (2) Effective when stable operation is required to move smoothly up from the lowest speeds.
- (3) Effective in elimination of load fluctuations caused by motor slippage.
- (4) Effective in producing high motor torque at low speed.

Set P_{L} to 3 (sensorless vector control) to operate multiple motors of the same type in parallel or to operate a motor with a two or more notches lower rating.

★Motor constant must be set.

The motor constant can be set in any of the following two ways:

1) Automatic setting

Enter the following information that is indicated on the motor nameplate, and then execute the auto-tuning 1 command (Set F_{400} to 4, and then reset F_{400} to 2.).

<Information indicated on motor nameplate>

ω_L (Base frequency), $\omega_L V$ (Base frequency voltage), F_{405} (Motor rated capacity), F_{406} (Motor rated current), F_{407} (Motor rated rotational speed)

⇒ Refer to 6.22 selection 2.

2) Manual setting

Set each motor constant manually.

⇒ Refer to 6.22 selection 3.

5) Setting of V/f characteristic arbitrarily

Setting of V/f control mode selection $P_{\text{L}} = 5$ (V/f 5-point setting)

In this mode, the base frequency and the base frequency voltage for the V/f control need to be set to operate the motor while switching a maximum of 5 different V/f characteristics.

[Parameter setting]

Title	Function	Adjustment range	Default setting
F_{190}	V/f 5-point setting VF1 frequency	0.0~FH Hz	0.0
F_{191}	V/f 5-point setting VF1 voltage	0.0~100% *	0.0
F_{192}	V/f 5-point setting VF2 frequency	0.0~FH Hz	0.0
F_{193}	V/f 5-point setting VF2 voltage	0.0~100% *	0.0
F_{194}	V/f 5-point setting VF3 frequency	0.0~FH Hz	0.0
F_{195}	V/f 5-point setting VF3 voltage	0.0~100% *	0.0
F_{196}	V/f 5-point setting VF4 frequency	0.0~FH Hz	0.0
F_{197}	V/f 5-point setting VF4 voltage	0.0~100% *	0.0
F_{198}	V/f 5-point setting VF5 frequency	0.0~FH Hz	0.0
F_{199}	V/f 5-point setting VF5 voltage	0.0~100% *	0.0

*100% adjustment value (200V class: 200V, 400V class: 400V)

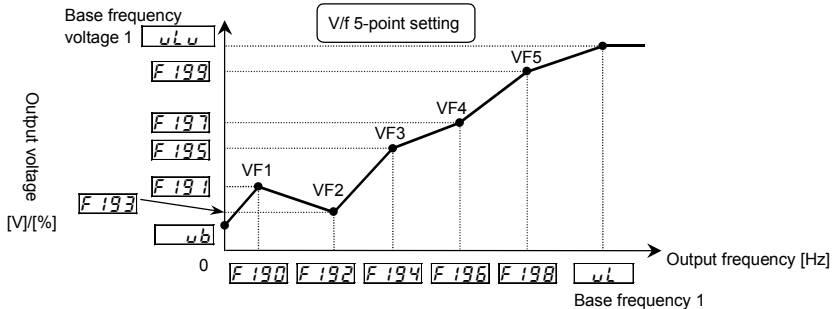

Note 1: Restrict the amount of torque to boost (ωb) to 3% or so. Boosting the torque too much may impair the linearity between points.

Note 2: If the V/f 5-point is set within the diagonally shaded area in the figure below, the V/f 5-point is placed automatically on the boundary line (heavy line in the figure).

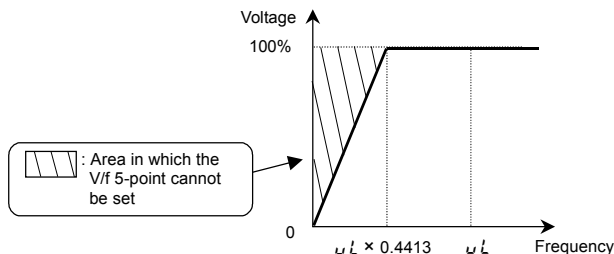

6) Operating a permanent magnet motor

Setting of V/f control mode selection $P_{\text{L}} = 5$ (PM control)

Permanent magnet motors (PM motors) that are light, small in size and highly efficient, as compared to induction motors, can be operated in sensorless operation mode. Note that this feature can be used only for specific motors. For more information, contact your supplier.

7) Operating the motor at periodic speeds by means of a motor speed sensor

Setting for V/f control mode selection $P_{\text{L}} = 7$ (PG feedback control)

Set P_{L} to 7 to operate the motor at periodic speeds.

Use this setting when operating a motor two or more ranks lower in capacity than the inverter at periodic speeds. A PG feedback device (optional) is needed. In addition, a motor with a speed sensor (encoder) should be used.

★Motor constant must be set.

The motor constant can be set in any of the following two ways:

1) Automatic setting

Enter the following information that is indicated on the motor nameplate, and then execute the auto-tuning 1 command (Set F_{400} to 4, and then reset F_{400} to 2).

<Information indicated on motor nameplate>

ω_L (Base frequency), $\omega_L u$ (Base frequency voltage), F_{405} (Motor rated capacity), F_{406} (Motor rated current), F_{407} (Motor rated rotational speed)

⇒ Refer to 6.19 selection 2.

2) Manual setting

Set each motor constant manually.

⇒ Refer to 6.19 selection 3.

8) Energy-saving

Setting of V/f control mode selection $P_{\text{t}} = 9$ (Energy-saving)

Energy can be saved in all speed areas by detecting load current and flowing the optimum current that fits the load.

★Motor constant must be set.

The motor constant can be set in any of the following two ways:

1) Automatic setting

Enter the following information that is indicated on the motor nameplate, and then execute the auto-tuning 1 command (Set F_{400} to 4, and then reset F_{400} to 2).

<Information indicated on motor nameplate>

ω_L (Base frequency), $\omega_L V$ (Base frequency voltage), F_{405} (Motor rated capacity), F_{406} (Motor rated current), F_{407} (Motor rated rotational speed)

⇒ Refer to 6.19 selection 2.

2) Manual setting

Set each motor constant manually.

⇒ Refer to 6.19 selection 3.

9) Achieving further energy-saving

Setting of V/f control mode selection $P_{\text{t}} = 10$ (Advanced energy-saving)

More substantial energy savings than those provided by setting P_{t} to 9 can be achieved in any speed range by keeping track of the load current and passing a current appropriate to the load.

★Motor constant must be set.

The motor constant can be set in any of the following two ways:

1) Automatic setting

Enter the following information that is indicated on the motor nameplate, and then execute the auto-tuning 1 command (Set F_{400} to 4, and then reset F_{400} to 2).

<Information indicated on motor nameplate>

ω_L (Base frequency), $\omega_L V$ (Base frequency voltage), F_{405} (Motor rated capacity), F_{406} (Motor rated current), F_{407} (Motor rated rotational speed)

⇒ Refer to 6.19 selection 2.

2) Manual setting

Set each motor constant manually.

⇒ Refer to 6.19 selection 3.

10) Precautions on vector control

- When operating a motor in automatic torque boost mode or vector control mode ($P_{\text{t}} = 2, 3$ or 7), enter each motor constant indicated on the nameplate (ω_L (base frequency), $\omega_L V$ (base-frequency voltage), F_{405} (rated capacity of motor), F_{406} (rated current of motor) and F_{407} (rated number of revolutions of motor)), read the precautions on auto-tuning 1 on section 6.19 (1), and then set F_{400} to 2 (auto-tuning). If the cable length is in excess of 30m, be sure to perform the auto-tuning ($F_{400}=2$) mentioned above, even when using a standard motor recommended by Toshiba.
- The sensorless vector control exerts its characteristics effectively in frequency areas below the base frequency (ω_L). The same characteristics will not be obtained in areas above the base frequency.
- Use a motor that has 2 to 16P.
- Always operate the motor in single operation (one inverter to one motor). (Except for; $P_{\text{t}}=3$) Sensorless vector control cannot be used when one inverter is operated with more than one motor.
- The torque produced by the motor decreases more or less around the rated frequency because of a voltage drop cause motor-generated torque in the vicinity of rated frequency to be somewhat lower.
- Connecting a reactor or surge voltage suppression filter between the inverter and the motor may reduce motor-generated torque. Setting auto-tuning 1 may also cause a trip ($E_{\text{t}n}, E_{\text{t}n} i-3$) rendering sensorless vector control unusable. In the event of a trip, perform auto-tuning with the inverter connected directly to the motor, or enter the motor constant calculated from the motor test results.
- Connect speed sensor for vector control with sensor to the motor. Connecting via gear, etc. causes motor's oscillating or inverter's trip by lack of rigidity.

5.7 Manual torque boost—increasing torque boost at low speeds

ub : Manual torque boost 1

• Function
If torque is inadequate at low speeds, increase torque by raising the torque boost rate with this parameter.

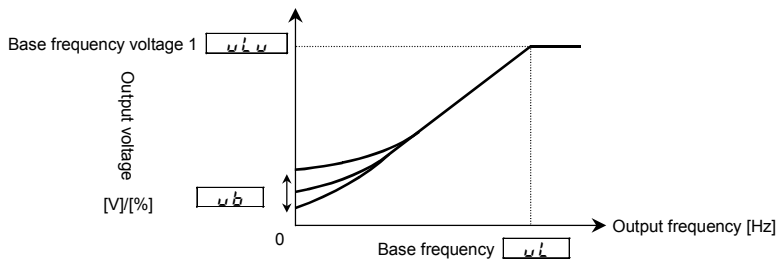

[Parameter setting]

Title	Function	Adjustment range	Default setting
ub	Manual torque boost 1	0.0~30.0 %	According to model ⇒ Refer to page K-41.

★This parameter is valid when $P\tau=0$ (Constant torque characteristics), I (square reduction torque), S (V/f 5-point setting).

Note: The optimum value is programmed for each inverter capacity. Be careful not to increase the torque boost rate too much because it could cause an overcurrent trip at startup. If you are going to change the set values, keep them within $\pm 2\%$ of the standard default values.

5.8 Base frequency

uL : Base frequency 1

uLU : Base frequency voltage 1

• Function
Sets the base frequency and the base frequency voltage in conformance with load specifications or the motor's rated frequency.

Note: This is an important parameter that determines the constant torque control area.

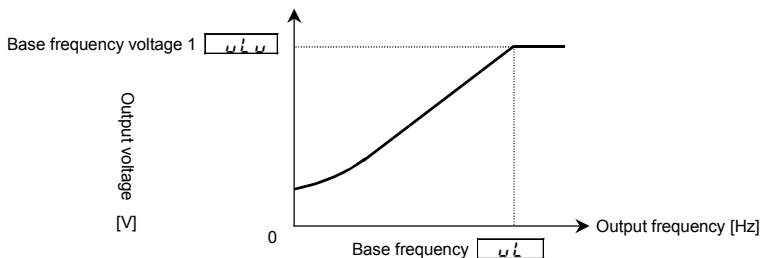

[Parameter setting]

Title	Function	Adjustment range	Default setting
uL	Base frequency 1	25.0~500.0 Hz	Inverter with a model number ending with -WN: 60.0 -WP: 50.0
uLU	Base frequency voltage 1	200V class: 50~330 V 400V class: 50~660 V	200V models: 230 400V models: Inverter with a model number ending with -WN: 460 -WP: 400

Note: The output frequency is limited to a frequency 10.5 times as high as the base frequency (uL). Even if the maximum frequency (FH) or the upper limit frequency (UL) is set above this frequency, this limitation is imposed on the output frequency.

5.9 Maximum frequency

FH : Maximum frequency

- Function
 - 1) Programs the range of frequencies output by the inverter (maximum output values).
 - 2) This frequency is used as the reference for acceleration/deceleration time.

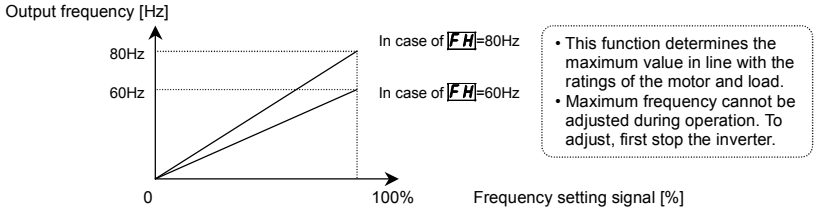

★ If *FH* is increased, adjust the upper limit frequency *UL* as necessary.

[Parameter setting]

Title	Function	Adjustment range	Default setting
<i>FH</i>	Maximum frequency	30.0~500.0 Hz	80.0

Note: The output frequency is limited to a frequency 10.5 times as high as the base frequency (*UL*). Even if the maximum frequency (*FH*) or the upper limit frequency (*UL*) is set above this frequency, this limitation is imposed on the output frequency.

5

5.10 Upper limit and lower limit frequencies

UL : Upper limit frequency

LL : Lower limit frequency

- Function

Programs the lower limit frequency that determines the lower limit of the output frequency and the upper limit frequency that determines the upper limit of that frequency.

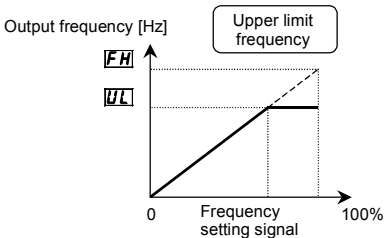

★ Frequencies that go higher than *UL* will not be output.

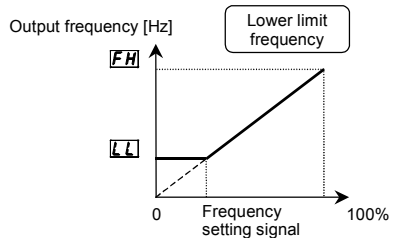

★ The output frequency cannot be set at less than *LL*.

[Parameter setting]

Title	Function	Adjustment range	Default setting
<i>UL</i>	Upper limit frequency	0.0~ <i>FH</i> Hz	Inverter with a model number ending with -WN: 60.0 -WP: 50.0
<i>LL</i>	Lower limit frequency	0.0~ <i>UL</i> Hz	0.0

5.11 Setting frequency command characteristics

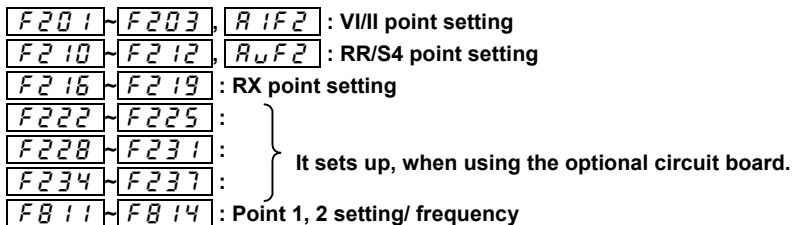

⇒ For details, refer to Section 7.3.

• Function

These parameters adjust the output frequency according to the externally applied analog signal (0~10Vdc voltage, 4(0)~20mAdc current) and the entered command for setting an external contact frequency.

5.12 Preset speed operation (speeds in 15 steps)

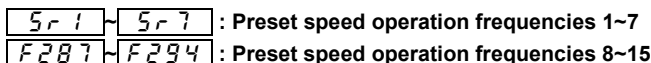

• Function

A maximum of 15 speed steps can be selected just by switching an external contact signal. Preset speed frequencies can be programmed anywhere from the lower limit frequency LL to the upper limit frequency UL.

[Setting methods]

1) Run/stop

Run and stop control is experienced by the operation panel (Default setting).

Title	Function	Adjustment range	Example of setting
FnOd	Command mode selection	0: Terminal input enabled 1: Operation panel input enabled (including LED/LCD option input) 2: 2-wire RS485 communication input 3: 4-wire RS485 communication input 4: Communication option input	0

Note 1: If speed commands (analog signal or digital input) are switched in line with preset speed operations, select the terminal board using the frequency setting mode selection 1 FnOd.

⇒ Refer to 3) or Section 5.5.

2) Preset speed frequency setting

Set the speed (frequency) of the number of steps necessary.

Setting from speed 1 to speed 7

Title	Function	Adjustment range	Default setting
5r1~5r7	Preset speed operation frequencies 1~7	LL~UL	0.0

Setting from speed 8 to speed 15

Title	Function	Adjustment range	Default setting
F287~F294	Preset speed operation frequencies 8~15	LL~UL	0.0

Example of preset speed contact input signal

○: ON -: OFF (Speed commands other than preset speed commands are valid when all are OFF)

Terminal	Preset speed														
	1	2	3	4	5	6	7	8	9	10	11	12	13	14	15
S1-CC	○	-	○	-	○	-	○	-	○	-	○	-	○	-	○
S2-CC	-	○	○	-	-	○	○	-	-	○	○	-	-	○	○
S3-CC	-	-	-	○	○	○	○	-	-	-	-	○	○	○	○
RR/S4-CC	-	-	-	-	-	-	-	○	○	○	○	○	○	○	○

★ Terminal functions are as follows. (Default setting)

- Terminal S1 Input terminal function selection 5 (S1) $F115 = 10$ (S1)
- Terminal S2 Input terminal function selection 6 (S2) $F115 = 12$ (S2)
- Terminal S3 Input terminal function selection 7 (S3) $F117 = 14$ (S3)
- Terminal RR/S4 Input terminal function selection 8 (S4) $F118 = 15$ (S4)

★The RR/S4 terminal is set by default as an analog voltage input terminal. To use it as an input terminal for preset speed operation, turn the SW3 switch to the S4 position.

[An example of the connection of terminals]

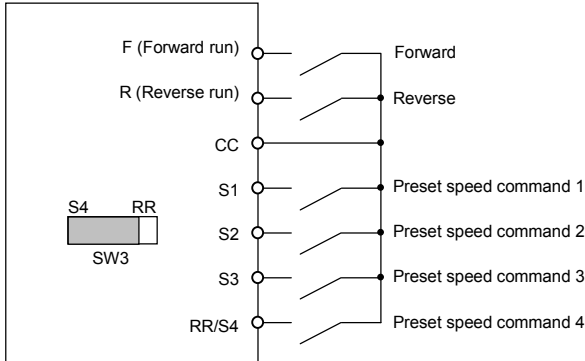

3) Using other speed commands with preset speed command

When no preset speed command is issued, the inverter accepts an input command from the operation panel or another analog input device.

Preset speed command	Other speed commands			
	Frequency setting signals from the operation panel		Analog signal input command (VI/II, RR/S4, RX, AI1 and AI2)	
	Entered	Not entered	Entered	Not entered
Entered	Preset speed command valid	Preset speed command valid	Preset speed command valid	Preset speed command valid
Not painted	Operation panel command valid	-	Analog signal valid	-

- ★The preset speed command is always given priority when other speed commands are input at the same time.
- ★To use the RR/S4 terminal as an analog input terminal, turn the SW4 switch to the RR position. Note that this makes it impossible to use the function assigned to S4.

Below is an example of 7-step speed operation.

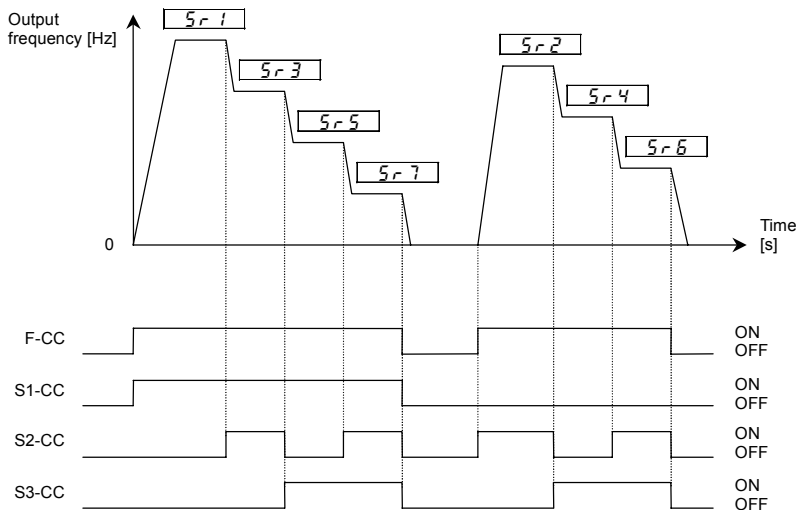

Example of 7-step speed operation

5.13 Selecting forward and reverse runs (operation panel only)

F_r : Forward/reverse run selection

• Function

Program the direction of rotation of the motor when the running and stopping are made using the RUN key and STOP key on the operation panel. Valid when $\overline{C} \overline{M} \overline{D}$ (command mode selection) = 1 (operation panel input).

[Parameter setting]

Title	Function	Adjustment range	Default setting
F_r	Forward/reverse run selection	$\overline{0}$: Forward run 1: Reverse run $\overline{2}$: Forward run (F/R switching possible) 3: Reverse run (F/R switching possible)	$\overline{0}$

★ Check the direction of rotation on the status monitor.

$F_r - F$: Forward run $F_r - r$: Reverse run

⇒ For monitoring, refer to Section 8.1.

★ When the F and R terminals are used for switching between forward run and stop from the terminal board, the F_r forward/reverse run selection parameter is rendered invalid.

Short across the F-CC terminals: forward run

Short across the R-CC terminals: reverse run

★ If F and CC, as well as R and CC are connected at the same time: Stop (Default setting)

Use the parameter $F \overline{1} \overline{0} \overline{5}$ to select between reverse run and stop in this case.

⇒ For more details, refer to Section 6.2.1.

★ This function is valid only when $\overline{C} \overline{M} \overline{D}$ is set at 1 (Operation panel input enabled).

★ To switch between forward run and reverse run from the control panel with parameter F_r set to $\overline{2}$ or 3, perform these steps: to switch to forward run, press the \bigwedge key while holding the ENT key down, or to switch to reverse run, press the \bigvee key while holding ENT key down.

5.14 Setting the electronic thermal

$\epsilon H r$: Motor electronic thermal protection level 1
$\sigma L n$: Electronic thermal protection characteristic selection
$F606$: OL reduction starting frequency
$F631$: Temperature detection

• Function

This parameter allows selection of the appropriate electronic thermal protection characteristics according to the particular rating and characteristics of the motor.

[Parameter setting]

Title	Function	Adjustment range				Default setting
$\epsilon H r$	Motor electronic thermal protection level 1	10~100 %				100
$\sigma L n$	Electronic thermal protection characteristic selection	Default setting	Motor type	Overload protection	Overload stall	0
		0	Standard Motor	○ (protect)	× (not stall)	
		1		○ (protect)	○ (stall)	
		2		× (not protect)	× (not stall)	
		3		× (not protect)	○ (stall)	
		4	VF Motor (special motor)	○ (protect)	× (not stall)	
		5		○ (protect)	○ (stall)	
		6		× (not protect)	× (not stall)	
7	× (not protect)	○ (stall)				

1) Setting the motor electronic thermal protection level 1 $\epsilon H r$ and electronic thermal protection characteristics selection $\sigma L n$

The electronic thermal protection characteristics selection $\sigma L n$ is used to enable or disable the motor overload trip function ($\sigma L 2$) and the overload stall function.

The motor overload trip function ($\sigma L 2$) needs to be selected with the parameter $\sigma L n$, while the inverter overload trip function ($\sigma L 1$) is always activated.

Explanation of terms:

Overload stall (Soft stall)

The function of automatically lowering the output frequency before the motor overload trip function $\sigma L 2$ is activated when the inverter detects that an excessive load is applied to the motor. (Lowers maximum about 48Hz when basic frequency is 60Hz.) This function enables the inverter to output a frequency commensurate with the load current so that the motor can keep running without tripping. This function is useful for such loads as fans, pump, and blowers, which have the square reduction torque characteristic that the current passed decreases as the rotating speed falls.

Note: Do not use this overload stall function for loads with a constant torque characteristic (to which a constant load current is always passed regardless of their speed).

[Using standard motors (other than motors intended for use with inverters)]

When a motor is used in the lower frequency range than the rated frequency, that will decrease the cooling effects for the motor. This speeds up the start of overload detection operations when a standard motor is used in order to prevent overheating.

■ Setting of electronic thermal protection characteristics selection $\sigma L n$

Default setting	Overload protection	Overload stall
0	○ (protect)	× (not stall)
1	○ (protect)	○ (stall)
2	× (not protect)	× (not stall)
3	× (not protect)	○ (stall)

■ Setting of motor electronic thermal protection level 1 $\boxed{\text{tHr}}$

If the capacity of the motor is smaller than the capacity of the inverter, or the rated current of the motor is smaller than the rated current of the inverter, adjust the electronic thermal protection level 1 tHr so that it fits the motor's rated current.

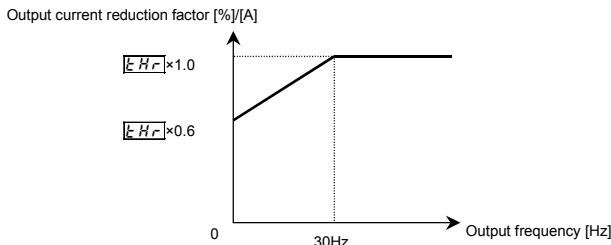

Note: The motor overload starting level is fixed at 30Hz. If necessary, set $\boxed{\text{OLn}}$ to 4, 5, 6 or 7. (See the following section.) Even if the inverter is used with a Toshiba standard motor, the load may need to be reduced at frequencies of 30Hz and more in some cases. In such cases, set $\boxed{\text{OLn}}$ to 4, 5, 6 or 7 and set the $\boxed{\text{OL}}$ reduction starting frequency ($\boxed{\text{F505}}$) according to the motor.

[Example of setting: When the VFPS1-2007PL is running with a 0.4kW motor having 2A rated current]

Key operated	LED display	Operation
	00	Displays the operation frequency. (Perform during operation stopped.) (When standard monitor display selection F710=0 [Output frequency])
(MODE)	RUH	The first basic parameter "History function (RUH)" is displayed.
(Δ) (∇)	tHr	Press either the Δ key or the ∇ key to change the parameter to tHr .
(ENT)	100	Press the ENTER key to display the parameter setting (Default setting: 100 %).
(Δ)	40	Press the Δ key to change the parameter to 40 (= motor rated current/inverter output rated current x 100 = 2.0/5.0 x 100)
(ENT)	40 \leftrightarrow tHr	Press the ENTER key to save the changed parameter. tHr and the parameter are displayed alternately.

[Using a VF motor (motor for use with inverter)]

■ Setting of electronic thermal protection characteristics selection $\boxed{\text{OLn}}$

Default setting	Overload protection	Overload stall
4	○ (protect)	× (not stall)
5	○ (protect)	○ (stall)
6	× (not protect)	× (not stall)
7	× (not protect)	○ (stall)

A VF motor (a motor for use with an inverter) can be used in lower frequency ranges than the standard motor, but if that frequency is extremely low, the effects of cooling on the motor will deteriorate.

In such a case, set the OL reduction start frequency parameter F505 according to the characteristics of the motor. (Refer to the figure below.)

As a guide, it is advisable to set this parameter around the default value (VF motor 6Hz).

[Parameter setting]

Title	Function	Adjustment range	Default setting
F505	OL reduction starting frequency	0.0~60.0 Hz	6.0

Note: F505 is enabled when $\boxed{\text{OLn}}=4\sim 7$.

5

■ Setting of motor electronic thermal protection level 1 $\boxed{E H r}$

If the capacity of the motor is smaller than the capacity of the inverter, or the rated current of the motor is smaller than the rated current of the inverter, adjust the electronic thermal protection level 1 $E H r$ so that it fits the motor's rated current.

* If the indications are in percentages[%], then 100% equals the inverter's rated output current [A].

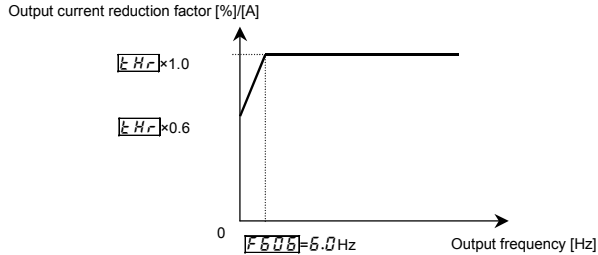

Setting the motor overload starting level

2) Inverter overload characteristics

Set to protect the inverter unit. Cannot be turned off by parameter setting.

The inverter has two overload detecting functions, which can be switched from one to another using parameter $F 5 3 i$ (temperature detection).

[Parameter setting]

Title	Function	Adjustment range	Default setting
$F 5 3 i$	Temperature detection	\emptyset : Standard (120%-60 sec.) i : Estimation of temperature	\emptyset

If the inverter overload trip function ($\emptyset i$) is activated frequently, this can be improved by adjusting the stall operation level $F 5 0 i$ downward or increasing the acceleration time $R E E$ or deceleration time $d E E$.

■ $F 5 3 i = \emptyset$ (Standard)

Protection is given uniformly regardless of ambient temperature, as shown by the 120%-60 sec overload curve in the figure below.

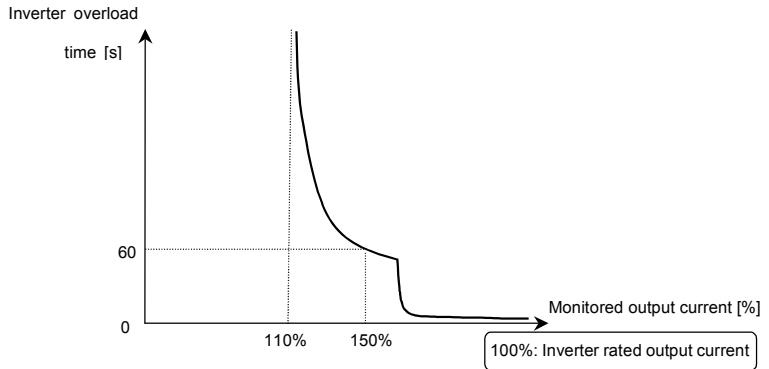

■ $F_{63} := t$ (Estimation of temperature)

This parameter adjusts automatically overload protection, predicting the inverter internal temperature rise. (diagonally shaded area in the figure below)

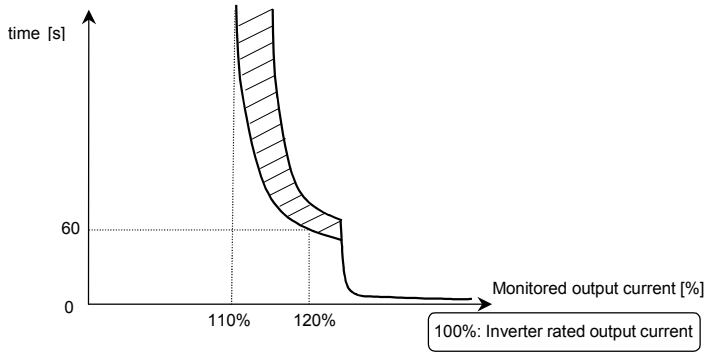

Inverter overload protection characteristics

Note 1: If the load applied to the inverter exceeds 120% of its rated load or the operation frequency is less than 0.1Hz, the inverter may trip ($\mathcal{O}L$ t or $\mathcal{O}L$ $tP \sim \mathcal{O}L$ $\mathcal{E}P$) in a shorter time.

Note 2: The inverter is factory-set so that, if the inverter becomes overloaded, it will automatically reduce the carrier frequency to avoid an overload trip ($\mathcal{O}L$ t or $\mathcal{O}L$ $tP \sim \mathcal{O}L$ $\mathcal{E}P$). A reduction in carrier frequency causes an increase in noise from the motor, but this does not affect the performance of the inverter.

If you do not want the inverter to reduce the carrier frequency automatically, set the parameter $F_{316} = 0$.

5

5.15 Changing the display unit % to A (ampere)/V (volt)

dSPU : Current/voltage unit selection

• Function

These parameters are used to change the unit of monitor display.

- % ⇔ A (ampere)/V (volt)
- Current 100% = Inverter's rated current
- 200V-class voltage 100% = 200Vac
- 400V-class voltage 100% = 400Vac

■ Example of setting

During the operation of the VFPS1-2037PL (rated current 16.6A) at the rated load (100% load), units are displayed as follows:

1) Display in percentage terms

C 100.

Output current:
100%

V 100.

DC voltage:
100%

2) Display in amperes/volts

C 16.6

Output current:
16.6A

V 200

DC voltage:
200V
(Converted into
AC voltage)

[Parameter setting]

Title	Function	Adjustment range	Default setting
dSPU	Current/voltage unit selection	0 : % 1 : % → A (ampere)/V (volt)	0

* The dSPU converts the following parameter settings:

- A display Current monitor display
 - Setting of electronic thermal protection level 1/2 tHr, F 173, F 611, F 640
 - DC braking current F 251
 - Stall prevention level F 601
- V display Voltage monitor display
 - V/f 5-point setting F 191, F 193, F 195, F 197, F 199

Note: Base frequency voltage 1, 2 (uL u, F 171) is always displayed in the unit of V.

5.16 Meter setting and adjustment

F75L	: FM terminal meter selection	F684	: FM output filter
F7	: FM terminal meter adjustment	A75L	: AM terminal meter selection
F678	: Constant at the time of filtering	A7	: AM terminal meter adjustment
F681	: FM voltage/current output switching	F685	: Inclination characteristic of AM output
F682	: Inclination characteristic of FM output	F686	: AM bias adjustment
F683	: FM bias adjustment		

• Function

Inverter's operation data is sent to the FM terminal (AM terminal) as analog voltage signals or analog current signals. To display inverter's operation data, connect a meter to this terminal. The "FM terminal-connected meter adjustment F7" (AM terminal-connected meter adjustment A7) parameter is used to calibrate the meter.

Note 1: The signal output from the FM and AM terminal is an analog voltage signal or an analog current signal. (positive (+) side output. For signed data, an absolute value is output. To output data with positive and negative signs, you need to use two extended terminal boards (optional).)

Note 2: To the FM terminal, connect either a full-scale 0~1mAdc ammeter or a full-scale 0~7.5Vdc (or 10Vdc) voltmeter, if necessary. The FM terminal can also be used as a 0(4)~20mAdc output terminal.

To the AM terminal, connect either a full-scale 0~1mAdc ammeter or a full-scale 0~7.5Vdc (or 10Vdc) voltmeter, if necessary.

Connect meters as shown below.

<Connection to terminal FM>

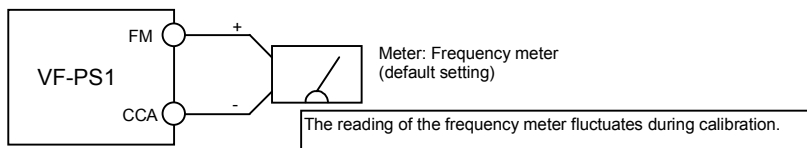

★A frequency meter QS60T is optionally available.

■ Output modes of the FM terminal

When used with a 0~1mAdc ammeter (Default setting)

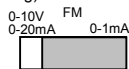

SW2

When used with a DC0~10V voltmeter

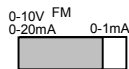

SW2
F68 I=0

When used with a 0(4)~20mAdc

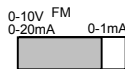

SW2
F68 I=1

When the optional frequency meter QS60T is connected, this mode is selected.

<Connection to terminal AM >

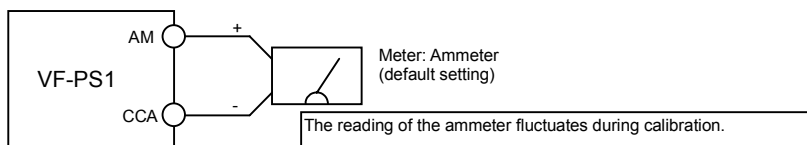

★It is recommendable to use an ammeter with a current rating 1.5 or more times as high as the output current rating of the inverter.

5

[Terminal FM-related parameters]

Title	Function	Adjustment range	Adjustment level	Default setting
F75L	FM terminal meter selection	0: Output frequency	(a)	
		1: Frequency command value	(a)	
		2: Output current	(b)	
		3: Input voltage (DC detection)	(c)	
		4: Output voltage	(c)	
		5: Compensated frequency *2	(a)	
		6: Speed feedback (real-time value)	(a)	
		7: Speed feedback (1 second filter)	(a)	
		8: Torque	(d)	
		9: Torque command	(d)	
		11: Torque current	(b)	
		12: Exiting current	(b)	
		13: PID feedback value	(a)	
		14: Motor overload factor (OL2 data)	(a)	
		15: Inverter overload factor (OL1 data)	(a)	
		16: Regenerative braking resistance overload factor (OLr data)	(a)	
		17: Regenerative braking resistor load factor (% ED)	(a)	
		18: Input power	(b)	
		19: Output power	(b)	
		23: Optional AI2 input	(a)	
		24: RR/S4 input	(a)	
		25: VI/II input	(a)	
		26: RX input	(a)	
		27: Optional AI1 input	(a)	
		28: FM output (Do not select this option.)	(a)	
		29: AM output	(a)	0
		30: Fixed output 1	-	
		31: Communication data output	-	
		32: Fixed output 2	-	
		33: Fixed output 3	-	
		34: Cumulative input power	(a)	
		35: Cumulative output power	(a)	
		45: Gain display	-	
		46: My function monitor 1	*1	
		47: My function monitor 2	*1	
48: My function monitor 3	*1			
49: My function monitor 4	*1			
50: Signed output frequency	(a)			
51: Signed frequency command value	(a)			
52: Signed compensated frequency	(a)			
53: Signed speed feedback (real-time value)	(a)			
54: Signed speed feedback (1 second filter)	(a)			
55: Signed torque	(d)			
56: Signed torque command	(d)			
58: Signed torque current	(b)			
59: Signed PID feedback value	(a)			
60: Signed RX input	(a)			
61: Signed optional AI1 input	(a)			
62: Signed fixed output 1	-			
63: Signed fixed output 2	-			
64: Signed fixed output 3	-			
F7	FM terminal meter adjustment	-		*3
F67B	Constant at the time of filtering *4	4 msec, 8 msec~ 100 msec		64
F681	FM voltage/current output switching	0: Voltage output (0~10V), 1: Current output (0~20mA)		0
F682	FM output gradient characteristic	0: Negative gradient (downward-sloping), 1: Positive gradient (upward-sloping)		1
F683	FM bias adjustment	- 10.0~ 100.0 %		0.0
F684	FM output filter	0: No filter 1: Filter approx. 10ms 2: Filter approx. 15ms 3: Filter approx. 30ms 4: Filter approx. 60ms		0

*1: Monitor adjustment level selected.

*2: "Compensated frequency" refers to the frequency actually sent from an inverter to the motor connected.

*3: Default setting value is adjusted for connection of frequency meters "QS60T".

(Between FM and CCA: Approx. 3.6V)

*4: The output current, input voltage, output voltage, compensated frequency, speed feedback (real-time value) torque, torque current and exciting current output (FM/AM/pulse and monitor output) can be filtered.

[Terminal AM-related parameters]

Title	Function	Adjustment range	Default setting
<i>Rn5L</i>	AM terminal meter selection	Same as <i>Fn5L</i> (<i>29</i> :AM output disabled)	<i>2</i>
<i>Rn</i>	AM terminal meter adjustment	—	*1
<i>F685</i>	AM output gradient characteristic	<i>0</i> :Negative gradient (downward-sloping), <i>1</i> :Positive gradient (upward-sloping)	<i>1</i>
<i>F686</i>	AM bias adjustment	— <i>10.0</i> ~ <i>100.0</i> %	<i>0.0</i>

*1: Default setting value is adjusted for connection of frequency meters "QS60T".

(Between AM and CCA: Approx. 3.6V)







Resolution

Both the terminals FM and AM have a maximum resolution of 1/1024.

★With the default settings, FM terminal outputs about 4.7V (external impedance is ∞) or about 1mA (external impedance is 80Hz). AM terminal outputs about 4.7V or about 1mA, when the output current reading on the operation panel is 185%.

[Example of the calibration of the frequency meter connected to the terminal FM]

* Use the meter's adjustment screw to pre-adjust zero-point.

Key operated	LED display	Operation
—	<i>60.0</i>	Displays the operation frequency. (When standard monitor display selection <i>F710=0</i> [Output frequency])
	<i>RUH</i>	The first basic parameter "History function (<i>RUH</i>)" is displayed.
	<i>Fn</i>	Press either the Δ or ∇ key to select " <i>Fn</i> ."
	<i>60.0</i>	Press the ENTER key to display the operation frequency.
	<i>60.0</i>	Press either the Δ key or the ∇ key to adjust the meter. The meter reading will change at this time but be careful because there will be no change in the inverter's digital LED (monitor) indication. <div style="border: 1px solid black; padding: 5px; width: fit-content; margin: 10px auto;"> [Hint] It's easier to make the adjustment if you push and hold for several seconds.</div>
	<i>60.0</i> \leftrightarrow <i>Fn</i>	★By setup, before the needle of meter beings to sway, it will take time. The adjustment is complete. <i>Fn</i> and the frequency are displayed alternately.
	<i>60.0</i>	The display returns to its original indications. (When standard monitor display selection <i>F710=0</i> [Output frequency])

★ For meter connection, the VF-PS1 inverter has two output terminals; FM and AM, which can be used simultaneously.

■ Meter adjustment 1 when the inverter is at rest (adjustment by setting *Fn5L* (*Rn5L*) to *30*: Fixed output 1, *32*: Fixed output 2, *33*: Fixed output 3)

If it is difficult to calibrate a meter because of large fluctuations of its reading, you may put the inverter out of operation to make its calibration easier.

It is possible to adjust the meter for the data item selected with the parameter *Fn5L* or *Rn5L*. Adjustment levels (a) through (d) shown in the table on the previous page change according to the settings of fixed outputs 1 through 3, as shown in the table below. Use this table as a reference when calibrating the meter(s).

Values adjusted with fixed outputs are put out from the FM (AM) terminal when values in the table are used for operation. For examples of adjustments, see the next page.

Fixed output 1 comes in handy for adjusting items at adjustment level (a) or (c).

Fixed output 2 comes in handy for adjusting items at adjustment level (b).

Fixed output 3 comes in handy for adjusting items at adjustment level (d).

Adjustment level	Meter adjustment		
	Fixed output 1 $FNSL (RNSL) = 30$	Fixed output 2 $FNSL (RNSL) = 32$	Fixed output 3 $FNSL (RNSL) = 33$
(a)	FH	54%	40%
(b)	185%	100%	74%
(c)	150%	81%	60%
(d)	250%	135%	100%

Note: The 100% value of input/output power is the product of $\sqrt{3} \times 200V (400V) \times$ inverter's rated current.

[Example: Procedure of calibrating the meter connected to the terminal AM to which "output current" is assigned.]

Key operated	LED display	Operation
-	0.0	Displays the operation frequency. (Perform during operation stopped.) (When standard monitor display selection $F \uparrow 10=0$ [Output frequency])
	RUH	The first basic parameter "History function (RUH)" is displayed.
	RNSL	Press either the Δ or ∇ key to select "RNSL."
	2	Pressing the ENTER key allows the reading of parameter setting.
	32	Set the parameter at 32 (fixed output for meter calibration 2) by pressing the Δ key.
	$32 \leftrightarrow RNSL$	Press the ENTER key to save the change. Then, RNSL and the set value are displayed alternately.
	AN	Select the AM terminal meter adjustment AN by pressing the ∇ key.
	100	Press the ENTER key to switch to the data display mode.
	100	Press either the Δ key or the ∇ key to adjust the meter. Adjust the pointer to the graduation to which you want it to point when the inverter passes a current 100% larger than its rated output current. (The meter reading will change at this time but be careful because there will be no change in the inverter's indication). <div style="border: 1px solid black; padding: 5px; display: inline-block;">  <p>[Hint] It's easier to make the adjustment if you push and hold for several seconds.</p> </div> <p>★By setup, before the needle of meter beings to sway, it will take time.</p>
	$100 \leftrightarrow AN$	Press the ENTER key to save the change. Then AN and the set value are displayed alternately.
	RNSL	Select the "AM terminal meter adjustment RNSL" by pressing the ∇ key.
	32	Pressing the ENTER key allows the reading of parameter setting.
	2	Return the parameter setting to 2 (output current display).
	$RNSL \leftrightarrow 2$	Press the ENTER key to save the change. Then, RNSL and the set value are displayed alternately.
	0.0	Press the MODE key three times to return to the running frequency display mode. (When standard monitor display selection $F \uparrow 10=0$ [Output frequency])

■ Gradient bias adjustment of analog monitor output

Here is an example of the adjustment of output from 0-20mA → 20-0mA, 4-20mA using the FM terminal.

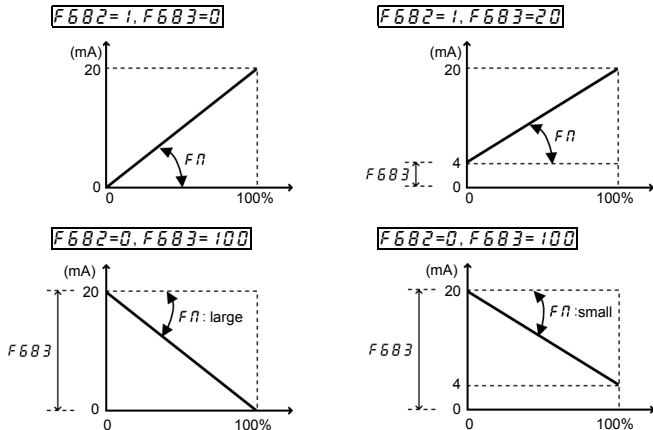

★The analog output inclination can be adjusted using the parameter F_n .

5

5.17 PWM carrier frequency

- [CF]** : PWM carrier frequency
- [F312]** : Random mode
- [F316]** : Carrier frequency control mode selection

- Function
- 1) The sound tone of acoustic noise can be changed by adjusting the PWM carrier frequency. This parameter is also effective in preventing the motor from resonating with its load machine or its fan cover.
 - 2) In addition, this parameter reduces the electromagnetic noise generated by the inverter. Reduce the carrier frequency to reduce electromagnetic noise. Note: Although the electromagnetic noise level is reduced, the magnetic noise of the motor is increased.
 - 3) The random mode reduces motor magnetic noise by changing the pattern of the reduced carrier frequency.
 - 4) To set the parameter $F316$ to 2 or 3 has the effect of suppressing voltage surge to the motor. Reduce the carrier frequency to less than 4kHz if the wiring between the inverter and motor is long (20 to 100m as a guide).

[Parameter setting]

Title	Function	Adjustment range	Default setting
[CF]	PWM carrier frequency	1.0~16.0kHz (2.5~8.0kHz) [Note 1]	According to model ⇒ Refer to page K-41.
[F312]	Random mode	0: Disabled, 1: Enabled	0
[F316]	Carrier frequency control mode selection	0: Not decrease carrier frequency automatically 1: Decrease carrier frequency automatically 2: Not decrease carrier frequency automatically, 400V class supported 3: Decrease carrier frequency automatically, 400V class supported	1

Note 1: For 200V-55kW to 200V-90kW models and 400V-90kW to 400V-630kW models, the carrier frequency is between 2.5 and 8.0kHz inclusive.

Note 2: If [CF] is set at 2.0kHz or above, it cannot be decreased below 2.0kHz during operation. Changes made to decrease [CF] below 2.0kHz take effect when operation is restarted after it is stopped.

Note 3: If [CF] is 1.9kHz or less, you cannot change the setting at 2.0kHz or more. Changes made to increase [CF] to 2.0kHz or above take effect immediately.

Note 4: If $P\pm$ (V/f control mode selection) is set to 2, 3 or 7, the inverter sets a lower limit of 2.0kHz for [CF].

Note 5: If you change the carrier frequency, you may need to reduce the inverter's continuous output current.

⇒ Refer to Section 1.4.4, "Current reduction curve."

Note 6: If the motor becomes overloaded when $F 3 15$ is set to 0 or 2 (carrier frequency not decreased automatically), an overload trip occurs.

Note 7: For the setting $F 3 15=2$ or 3 to take effect, power needs to be turned off and then turned back on. And this parameter is invalidated for the ratings of 90 kW and over.

Note 8: When setting $F 3 15$ to 2 or 3, be sure to set $C F$ at 4.0kHz or less.

Note 9: When setting $C F$ to 1~1.9, be sure to set $F 6 0 1$ at 130% or less.

5.18 Trip-less intensification

5.18.1 Auto-restart (Restart during coasting)

U U 5 : Auto-restart control selection

Warning	
 Mandatory	<ul style="list-style-type: none"> Do not go near motors and equipment. Motors and equipment that have stopped temporarily after momentary power failure will restart suddenly after recovery. This could result in unexpected injury. Attach warnings about sudden restart after a momentary power failure on inverters, motors and equipment for prevention of accidents in advance.

Function

Auto-restart detect the rotating speed and direction of rotation of the motor during coasting or momentary power failure, to ensure that the motor restarts smoothly (Motor speed search function). This parameter also allows commercial power operation to be switched to inverter operation without stopping the motor. During operation, "r t r 4" is displayed.

1) Auto-restart after momentary power failure (Auto-restart function)

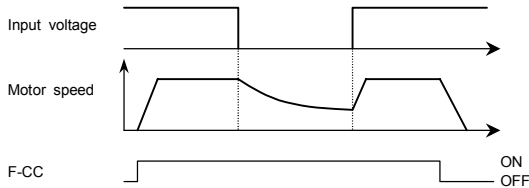

★ $U U 5 = 1$: This function operates after power has been restored following detection of an undervoltage by the main circuits and control power.

Title	Function	Adjustment range	Default setting	Example of setting
$U U 5$	Auto-restart control selection	0: Disabled 1: At auto-restart after momentary stop 2: When turning ST operation standby signal on or off [Note 1] 3: 1. + 2 4: At start-up	0	1 or 3

Note 1: ST standby signal can be turned on and off by turning on and off the terminal to which it is assigned.

Example: When ST standby signal is assigned to the S3 terminal, setting $U U 5$ to 2, $F 1 1 0$ to 0 (cancels the "ST standby signal always ON" setting. By default, this parameter is set to 5: always ON.) and $F 1 1 7$ to 5 (assigns ST standby signal to the S3 terminal) makes it possible to momentarily stop and restart the motor by just turning the S3 terminal off and then back on.

* If the motor is restarted in retry mode, this function will operate, regardless of the setting of this parameter.

* The function ($U U 5 = 1, 2, 3, 4$) is activated when the reset of trip or the power is turned on.

* The function ($U U 5 = 1, 3$) is activated when an undervoltage is detected in the main circuit.

5

2) Restarting motor during coasting (Motor speed search function)

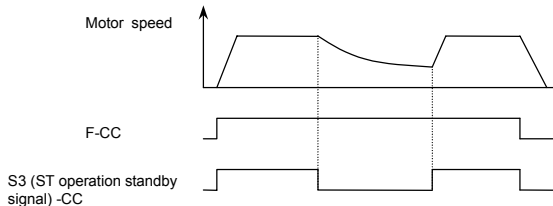

★ $U_{U5}=2$: This function operates after the S3-CC terminal connection has been opened first and then connected again.

Example: When ST standby signal is assigned to the S3 terminal, setting U_{U5} to 2, $F110$ to 0 (cancels the “ST standby signal always ON” setting. By default, this parameter is set to 5: always ON.) and $F117$ to 5 (assigns ST standby signal to the S3 terminal) makes it possible to momentarily stop and restart the motor by just turning the S3 terminal off and then back on.

Title	Function	Adjustment range	Default setting	Example of setting
U_{U5}	Auto-restart control selection	0:Disabled 1:At auto-restart after momentary stop 2:When turning ST operation standby signal on or off 3: 1. + 2 4:At start-up	0	2 or 3

* To restart the inverter in operation panel operation mode, press RUN key after a power failure.

* When $F375$ (Number of PG input phases) = 1 (single phase) in PG feedback vector control mode ($Pt=5$), the inverter may trip ($E-13$: speed error) if the direction of rotation of the motor does not agree with.

Operation and application of the auto-restart function

- By using retry function $F303$ together, auto restart function can be actuated at the time of tripping.
- The motor coasts during the waiting period between the entry of a start command and the start of operation. If the coasting of the motor during this period does harm to the machine, do not use the retry function.
- At restart, it takes several seconds. for the inverter to check to see the number of revolutions of the motor. For this reason, the start-up takes more time than usual.
- When the auto restart function is selected, this function is actuated also at time of activation of motor and at the first operation after the reset of tripping. The operation will restart after the waiting time passes.
- Use this function when operating a system with one motor connected to one inverter. This function may not operate properly in a system configuration with multiple motors connected to one inverter.

5

5.18.2 Regenerative power ride-through control/Deceleration stop during power failure

failure

U_uC : Regenerative power ride-through control

F₃I₀ : Non-stop control time/Deceleration time during power failure

- Function**
- 1) Regenerative power ride-through control: When momentary power failure occurs during operation, this function makes operation continue using the regeneration energy from a motor.
 - 2) Deceleration stop during power failure: When momentary power failure occurs during operation, this function stops the motor quickly compulsorily. A forcible stop is carried out in F₃I₀ (Deceleration time) using the regeneration energy from the motor.
(Deceleration time varies with control.)
After the forced stop, the inverter remains static until you put off the operation command momentarily.

[Parameter setting]

Title	Function	Adjustment range	Default setting
U _u C	Regenerative power ride-through control selection	0: Disabled 1: Power ride-through 2: Deceleration stop during power failure:	0
F ₃ I ₀	Non-stop control time/Deceleration time during power failure	0.1~320.0 sec.	2.0

Note 1: The power ride-through control time when U_uC = 1 depends on the setting of F₃I₀, and the deceleration time when U_uC = 2 depends on the setting of F₃I₀.

Note 2: Even if these functions are used, a motor may coast according to load conditions.
In this case, use the auto-restart function along with this parameter function.

Note 4: Although the setting of F₃I₀ can be written when U_uC is set to 1 (non-stop control), it cannot be written when U_uC is set to 2 (momentary power failure slowdown stop).

■ An example of setting when U_uC = 1
[When power is interrupted]

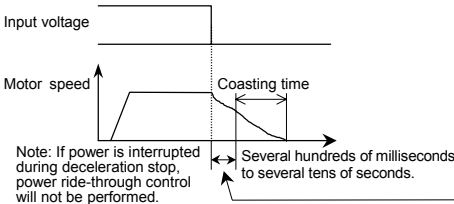

★ The time for which the operation of the motor can be continued depends on the machine inertia and load conditions. Before using this function, therefore, perform verification tests.

★ Use with the retry function allows the motor to be restarted automatically without being brought to an abnormal stop.

[If momentary power failure occurs]

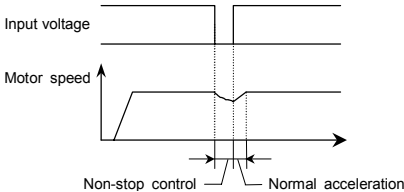

5

■ An example of setting when $U_{\text{L}} \leq 2$

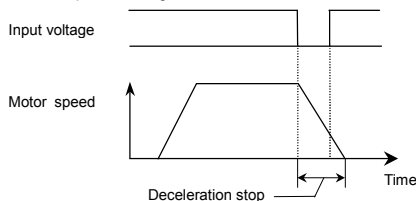

- Even after the recovery from an input power failure, the motor continues slowing down to a stop. If the voltage in the inverter main circuit falls below a certain level, however, control will be stopped and the motor will coast.
- The deceleration time varies according to the setting of $F310$. In this case, the deceleration time refers to the time elapsed before a motor running at FH (maximum frequency) comes to a full stop.

5.19 Dynamic (regenerative) braking - For abrupt motor stop

- Pb : Dynamic braking selection
- Pbr : Dynamic braking resistance
- $PbCP$: Allowable continuous braking resistance
- $F639$: Braking resistance overload time

• **Function**

Dynamic braking is used in the following cases:

- 1) Need to stop the motor quickly.
- 2) The inverter trips because of an overvoltage (OP) during deceleration.
- 3) Fluctuation of load condition causes a regenerative power even at a constant speed such as press machine.

[Parameter setting]

Title	Function	Adjustment range	Default setting
Pb	Dynamic braking selection	0: Disabled 1: Enabled (braking resistance overload detect) 2: Select (braking resistance overload not detect)	0
Pbr	Dynamic braking resistance	0.5 ~ 1000 Ω	According to model ⇒ Refer to page K-41.
$PbCP$	Allowable continuous braking resistance	0.0 ~ 6000.0 kW	According to model ⇒ Refer to page K-41.
$F639$	Braking resistance overload time	0.1 ~ 600.0 sec.	5.0

* Default settings vary from model dependent. ⇒ Refer to page E-38, 39.

Protection levels defined by $F626$ (Refer to Section 6.15.2).

Note 1: The time set using $F639$ is the time for which the resistor sustains an overload. (Enter the time elapsed before the inverter trips if a load 10 times as large as the allowable continuous braking resistance specified using $PbCP$ is applied.) There is no need to change resistance settings recommended by Toshiba (except DGP resistance setting).

Note 2: If the parameter Pb is set to 1 or 2 (regenerative braking selected), the inverter will be set automatically so as to deal with the regenerative energy from the motor by means of a resistor, without taking any action to limit overcurrent. (The same function as $F305 = 1$)

Note 3: For inverters with ratings of 400V-250kW or more, set Pb to 0, because separate dynamic braking units are not included as standard equipment.

All 200V VF-PS1 and 400V VF-PS1 with ratings of up to 220kW have built-in dynamic braking transistors as standard equipment. If the rating of your inverter falls within this range, connect the resistor, as shown in Figure a) below or Figure b) on the next page. If your inverter has a power rating of 250kW or more, connect a resistor, as shown in Figure c).

Connecting an external braking resistor (optional)

a) External braking resistor (with a thermal fuse) (optional)

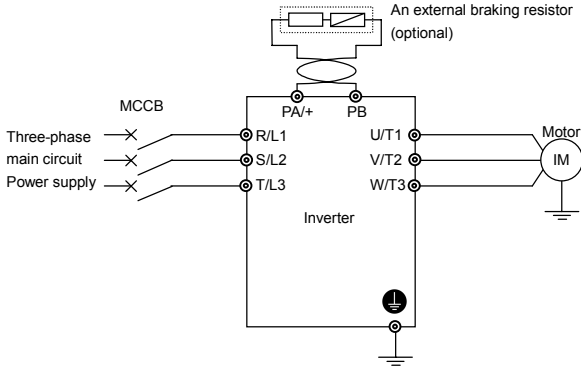

[Parameter setting]

Title	Function	Adjustment range	Example of setting
P_b	Dynamic braking selection	0 : Disabled 1 : Enabled (braking resistance overload detect) 2 : Select (braking resistance overload not detect)	1

★Do not connect an external resistor with a resistance (combined resistance) smaller than the minimum admissible resistance.

For overload protection, be sure to set the parameters P_{br} and P_{bcP} properly.

[Parameter setting]

Title	Function	Adjustment range	Example of setting
P_{br}	Dynamic braking resistance	$0.5 \sim 1000 \Omega$	Any value
P_{bcP}	Allowable continuous braking resistance	$0.0 \sim 600.0 \text{ kW}$	Any value
$F639$	Braking resistance overload time	$0.1 \sim 600.0 \text{ sec.}$	Set the parameter to 5.0 for type PBR*- or to any value for other types.

b) When a using braking resistor without thermal fuse

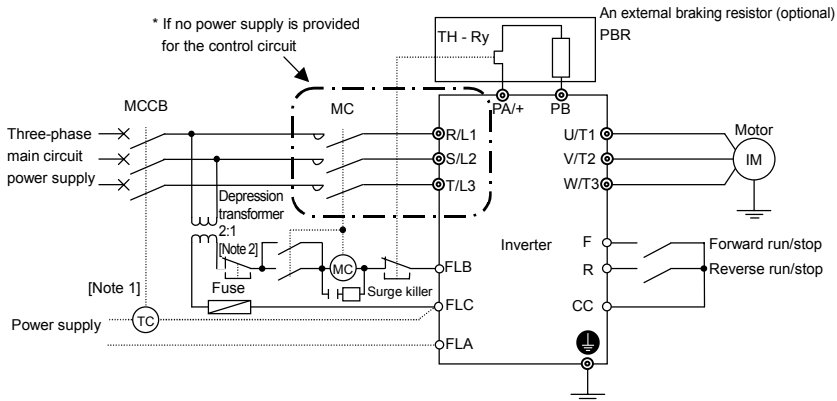

Note 1: Connection when using an MCCB with a top coil instead of an MC.

Note 2: A depression transformer is required for 400V models but not for 200V models.

[Parameter setting]

Title	Function	Adjustment range	Example of setting
P_b	Dynamic braking selection	0: Disabled 1: Enabled (braking resistance overload detect) 2: Select (braking resistance overload not detect)	1
P_{br}	Dynamic braking resistance	0.5 ~ 1000 Ω	Any value
P_{bcP}	Allowable continuous braking resistance	0.0 ~ 600.0 kW	Any value

(When the thermal braking resistor option is not used, be sure to set the parameters P_{br} and P_{bcP} properly for overload protection.)

* As a last resort to prevent fire, be sure to connect a thermal relay (THR). Although the inverter has a means of preventing overload and overcurrent to protect the braking resistor, the thermal relay is activated in case the protection function fails to work. Select and connect a thermal relay (THR) appropriate to the capacity (wattage) of the braking resistor.

- Warning -

In the above circuit, the MC in the main circuit is turned off if an inverter's protective function is activated, and consequently no trip message is displayed. The inverter recovers from a trip if it is turned off. So, check the trip history record after turning off the inverter and then on again. → Refer to Section 8.2.1.

To prevent a trip condition from being cleared by turning off the power and then on again, change the setting of the inverter trip retention selection parameter $F602$. → Refer to Section 6.26.2.

c) Capacities of 400V-250kW or more

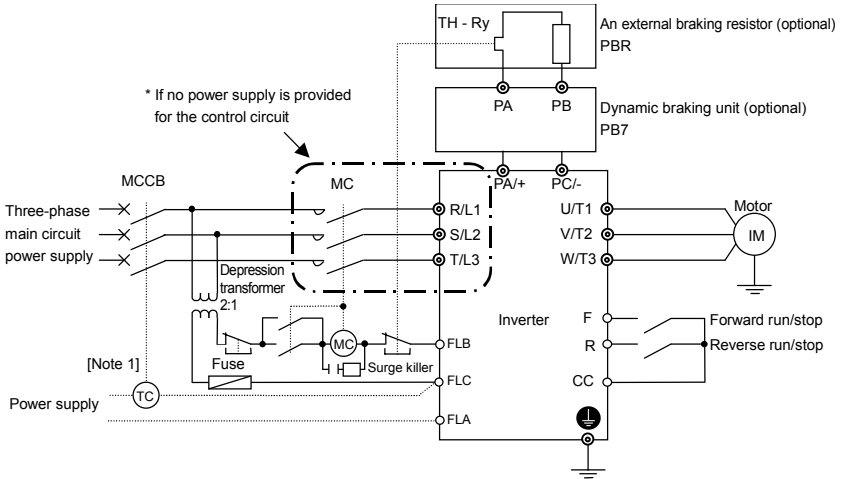

Note 1: Connection when using an MCCB with a top coil instead of an MC.

[Parameter setting]

Title	Function	Adjustment range	Example of setting
P_b	Dynamic braking selection	0: Disabled 1: Enabled (braking resistance overload detect) 2: Select (braking resistance overload not detect)	0

* As a last resort to prevent fire, be sure to connect a thermal relay (THR). Although the inverter has a means of preventing overload and overcurrent to protect the braking resistor, the thermal relay is activated in case the protection function fails to work. Select and connect a thermal relay (THR) appropriate to the capacity (wattage) of the braking resistor.

- Warning -

In the above circuit, the MC in the main circuit is turned off if an inverter's protective function is activated, and consequently no trip message is displayed. The inverter recovers from a trip if it is turned off. So, check the trip history record after turning off the inverter and then on again. ⇒ Refer to Section 8.2.1.

To prevent a trip condition from being cleared by turning off the power and then on again, change the setting of the inverter trip retention selection parameter F_{E02} . ⇒ Refer to Section 6.26.2.

■ Selection of braking resistor option and braking unit

Standard braking resistors are listed in the table below.

The usage rate is 3%. (Except for type DGP***)

Inverter type	Braking resistor		
	Model number [Note 2]	Rating	Continuous regenerative braking allowable capacity [Note 1]
VFPS1-2004PL, 2007PL	PBR-2007	120W -200Ω	90W
VFPS1-2015PL, 2022PL	PBR-2022	120W -75Ω	90W
VFPS1-2037PL	PBR-2037	120W - 40Ω	90W
VFPS1-2055PL	PBR3-2055	240W - 20Ω	96W
VFPS1-2075PL	PBR3-2075	440W 15	130W
VFPS1-2110PM	PBR3-2110	660W -10Ω	200W
VFPS1-2150PM, 2185PM	PBR3-2150	880W -7.5Ω	270W
VFPS1-2220PM	PBR3-2220	1760W -3.3Ω	610W
VFPS1-2300PM	PBR3-2220	1760W - 3.3Ω	610W
VFPS1-2370PM ~2550P	PBR-222W002	2200W - 2Ω	1000W
VFPS1-2750P, 2900P	DGP600W-B1	3.4kW - 1.7Ω	3400W
VFPS1-4007PL ~4022PL	PBR-2007	120W - 200Ω	90W
VFPS1-4037PL	PBR-4037	120W -160Ω	90W
VFPS1-4055PL	PBR3-4055	240W - 80Ω	96W
VFPS1-4075PL	PBR3-4075	440W -60Ω	130W
VFPS1-4110PL	PBR3-4110	660W - 40Ω	190W
VFPS1-4150PL, 4185PL	PBR3-4150	880W -30Ω	270W
VFPS1-4220PL	PBR3-4220	1760W - 15Ω	540W
VFPS1-4300PL	PBR3-4220	1760W- 15Ω	540W
VFPS1-4370PL ~4750PL	PBR-417W008	1760W -8Ω	1000W
VFPS1-4900PC ~4160KPC	DGP600W-B2	7.4kW - 3.7Ω	7400W
VFPS1-4220KPC	DGP600W-B3	8.7kW -1.9Ω	8700W
VFPS1-4250KPC ~4315KPC	[Note 3] PB7-4200K + DGP600W-B4	14kW - 1.4Ω	14000W
VFPS1-4400KPC	[Note 3] PB7-4400K + DGP600W-B3 ×2 (parallel)	17.4kW -0.95Ω	17400W
VFPS1-4500KPC, 4630KPC	[Note 3] PB7-4400K + DGP600W-B4 ×2 (parallel)	28kW -0.7Ω	28000W

Note 1: Continuous regenerative braking allowable capacities vary according to the rated capacity and resistance of the resistor for reasons of endurance.

Note 2: PBR-□□□□, PBR3-□□□□ and DGP600W-B□: Braking resistor (Connected to PA/+, PB terminal)

Note 3: PB7-4□□□: Braking unit (Connected to PA/+, PC/- terminal)

Combined braking resistor (Connected to PA/+, PB terminal of PB7-4□□□)

■ **Minimum resistance of connectable braking resistors**

The minimum allowable resistance values of the externally connectable braking resistors are listed in the table below.

Do not connect braking resistors with smaller resultant resistance than the listed minimum allowable resistance values.

(For 250kW or greater models, a dynamic braking resistor drive unit (optional separate unit) is needed.)

Inverter Related output capacity (kW)	200V Class		400V Class	
	Resistance of standard option	Minimum allowable resistance	Resistance of standard option	Minimum allowable resistance
0.4	200	50	—	—
0.75	200	50	200	50
1.5	75	35	200	50
2.2	75	20Ω	200	50
3.7	40	15	160	40
5.5	20	11	50	30
7.5	15	8	50	20
11	10	6	40	20
15	7.5	5	30	13.3Ω
18.5	7.5	3.3Ω	30	13.3Ω
22	5.3	3.3	15	3.3
30	3.3	2.5Ω	13.3	10Ω
37	2	1.7	8	1.7
45	2	1.7	8	5
55	2	1.7	8	5
75	1.7	1.3	8	1.3
90	1.7	1	7	2.5
110	—	—	7	1.9
132	—	—	7	1.9
160	—	—	7	1.9
220	—	—	9	1.9Ω
250	—	—	4	1
280	—	—	4	1
315	—	—	4	1
400	—	—	0.95Ω	0.7Ω
500	—	—	0.7Ω	0.7Ω
630	—	—	0.7Ω	0.7Ω

5.20 Standard default setting

tYP : Factory default setting

• Function

This parameter is to set two or more parameters at a time for different commands. Using this parameter, all parameters can be also return to their respective default settings by one operation, and save or set specific parameters individually.

Title	Function	Adjustment range	Default setting
tYP	Factory default setting	0 : - 1 :50Hz default setting 2 :60Hz default setting 3 :Factory default setting 4 :Trip clear 5 :Cumulative operation time cleared 6 :Initialization of type information 7 :Save user-defined parameters 8 :Reset of user-defined parameters 9 :Cumulative fan operation time record clear 10 :Acceleration/deceleration time setting 0.01 sec.~600.0 sec. [Note 4] 11 :Acceleration/deceleration time setting 0.1 sec.~6000 sec.	0

Note 1: This parameter is used to change the settings of other parameters. Therefore, 0 is always displayed.

Note 2: tYP cannot be set during the inverter operating. Always stop the inverter first and then program.

Note 3: When parameter tYP is invoked, the value set previously is displayed on the left side of the parameter.

Note 4: If tYP is set to 10 , the optional communication devices DEV002Z, PDP002Z and CCL001Z cannot be used with the inverter. (The personal computer communications software PCMO01Z cannot be used, either.)

Furthermore, the copy function of the LED extended panel option (RKP002Z) does not work normally, so use only the parameter setting function and the monitoring function.

Note 5: If the power is turned off while the parameter tYP is being set, an error (EEP2) will occur when the power is turned back on. If the EEP2 error occurs, set tYP again.

[Programmed value]

50Hz default setting ($\text{tYP}=1$)

Setting tYP at 1 causes all the following parameters to be set for operation using a base frequency of 50Hz.

(This does not change the settings of any other parameters.)

- Upper limit frequency UL : 50Hz
- Base frequency $2F170$: 50Hz
- Maximum frequency FH : 50Hz
- Base frequency $1UL$: 50Hz
- RR/S4 input point 2 frequency $RUF2$: 50Hz
- VI/II input point 2 frequency $RIF2$: 50Hz
- RX input point 2 frequency $F219$: 50Hz
- AI1 input point 2 frequency $F225$: 50Hz
- AI2 input point 2 frequency $F231$: 50Hz
- RP/high-speed pulse input point 2 frequency $F237$: 50Hz
- Commercial power/inverter switching frequency $F355$: 50Hz
- PID deviation upper limit $F364$: 50Hz
- PID deviation lower limit $F365$: 50Hz
- Process upper limit $F367$: 50Hz
- PID output upper limit $F370$: 50Hz
- Motor rated rotational speed $F407$: 1400~1480min-1 (According to model)
- Point 2 frequency $F814$: 50Hz

60Hz default setting ($\text{tYP}=2$)

Setting tYP at 2 causes all the following parameters to be set for operation using a base frequency of 60Hz.

(This does not change the settings of any other parameters.)

- Upper limit frequency UL : 60Hz
- Base frequency $2F170$: 60Hz
- Maximum frequency FH : 60Hz
- Base frequency $1UL$: 60Hz
- RR/S4 input point 2 frequency $RUF2$: 60Hz
- VI/II input point 2 frequency $RIF2$: 60Hz
- RX input point 2 frequency $F219$: 60Hz
- AI1 input point 2 frequency $F225$: 60Hz
- AI2 input point 2 frequency $F231$: 60Hz
- RP/high-speed pulse input point 2 frequency $F237$: 60Hz
- Commercial power/inverter switching frequency $F355$: 60Hz
- PID deviation upper limit $F364$: 60Hz
- PID deviation lower limit $F365$: 60Hz
- Process upper limit $F367$: 60Hz
- PID output upper limit $F370$: 60Hz
- Motor rated rotational speed $F407$: 1680~1775min-1 (According to model)
- Point 2 frequency $F814$: 60Hz

Default setting (EYP=3)

Setting parameter EYP to 3 resets all parameters except the following to their default settings.

★When this parameter is set to 3, [TrIk] is displayed for a while, then switches back to the original display (OFF or 0.0). Note that this setting also clears all trip history records. Trip history data will be cleared at this time.

Following parameters are designed considering maintenance that they cannot be reset to the factory default setting even if you set the parameter EYP at 3. Following parameters are not displayed on the user parameter group G r U even if their settings are different from their default settings. So please be careful.

Title	Function
RUH	History function
F75L	FM terminal meter selection
F7	FM terminal meter adjustment
R75L	AM terminal meter selection
R7	AM terminal meter adjustment
F108	Analog VI/VII voltage/current switching
F109	Analog AI2 (optional circuit board) voltage/current switching
F470	VI/II input bias
F471	VI/II input gain
F472	RR/S4 input bias
F473	RR/S4 input gain
F474	RX input bias
F475	RX input gain
F476	Optional AI1 input bias
F477	Optional AI1 input gain

Title	Function
F478	Optional AI2 input bias
F479	Optional AI2 input gain
F669	Logic output/pulse train output selection (OUT1)
F672	MON1 terminal meter selection
F673	MON1 terminal meter adjustment
F674	MON2 terminal meter selection
F675	MON2 terminal meter adjustment
F681	FM voltage/current output switching
F688	MON1 voltage/current output switching
F691	MON2 voltage/current output switching
F751~ F782	Quick registration parameter 1~32
F880	Free notes
F899	Network option reset setting

Trip clear (EYP=4)

Setting EYP to 4 initializes the past four sets of recorded trip history data.

* (The parameter does not change.)

Cumulative operation time clear (EYP=5)

Setting EYP to 5 resets the cumulative operation time monitor to the initial value (0 [zero] time).

Initialization of type information (EYP=6)

When a trip occurs because of a type error (E EYP is displayed), you can clear the trip by setting EYP to 6. This function is used to reformat a control circuit board to adapt it to an inverter, for example, when a circuit board is removed from an inverter to use another inverter for maintenance or for other reasons. This setting clears all type data stored in the inverter.

Save user-defined parameters (EYP=7)

Setting EYP to 7 causes all the current parameter settings to be stored individually.

Reset of user-defined parameters (EYP=8)

Setting EYP to 8 returns all parameters to the settings saved by setting the parameter EYP = 7.

* The above settings 7 and 8 allows you to have your own default parameter settings.

Cumulative fan operation time clear (EYP=9)

Setting EYP to 9 resets the cumulative fan operation time to the initial value (0 [zero] time). Set this parameter when replacing the cooling fan, and so on.

Acceleration/deceleration time setting: 0.01 to 600.0 sec. (EYP=10)

When EYP is set to 10, the acceleration/deceleration time can be set within a range of 0.01 to 600.0 sec.

Acceleration/deceleration time setting: 0.1 to 6000 sec. (EYP=11)

When EYP is set to 11, the acceleration/deceleration time can be set within a range of 0.1 to 6000 sec.

5.21 Searching for all reset parameters and changing their settings

U r U : Automatic edit function

• **Function**

Automatically searches for only those parameters that are programmed with values different from the standard default setting and displays them in the user parameter group **U r U**. Parameter setting can also be changed within this group.

Note 1: If you reset a parameter to its factory default, the parameter will no longer appear in **U r U**.

Note 2: It may take several seconds to display changed parameters because all data stored in the user parameter group **U r U** is checked against the factory default settings. To cancel the parameter group search in process, press the **MODE** key.

Note 3: Parameters which cannot be reset to the default setting after setting **U P** to **3** are not displayed.

⇒ Refer to Section 5.20 for details.

■ How to search and reprogram parameters

The operations of search and resetting of parameters are as follows.

Key operated	LED display	Operation
	0.0	Displays the operation frequency (operation stopped). (When standard monitor display selection F 7 is 0 [Output frequency])
MODE	RUH	The first basic parameter "History function (RUH)" is displayed.
▲ ▼	U r U	Press ▲ or ▼ key to select U r U .
ENT	U - -	Press the ENTER key to enable the user parameter automatic edit function.
ENT or ▲ ▼	RCC	Searches for parameters that are different in value from the standard default setting and displays those parameters. Press the ENTER key or the ▲ key to change the parameter displayed. (Press the ▼ key to search for parameters in reverse direction.)
ENT	B.0	Press the ENTER key to display the set value.
▲ ▼	S.0	Press the ▲ key and ▼ key to change set value.
ENT	S.0 ↔ RCC	Press the ENTER key to save the changed value. The parameter name and the programmed value will flash on and off alternately.
▲ (▼)	U - - F (U - - r)	Use the same steps as those given above to display parameters that you want to search for or change setting with the ▲ key and ▼ key.
▲ (▼)	U - -	When U - - appears again, the search is ended.
MODE MODE	Parameter display ↓ F r - F ↓ 0.0	A search can be canceled by pressing the MODE key. Press the key once while the search is underway to return to the display of parameter setting mode. After that you can press the MODE key to return to the status monitor mode or the standard monitor mode (display of operation frequency).

5.22 EASY key function

PSEL : Registered parameter display selection

F751 - **F782** : Quick registration parameter 1~32

F750 : EASY key function selection

- **Function**
- The following three functions can be assigned to the EASY key for easy operation by means of a single key.
- Setting monitor mode switching function
- Shortcut key function
- Local/remote key function

[Parameter setting]

Title	Function	Adjustment range	Default setting
PSEL	Registered parameter display selection	0: Standard setting mode at time of activation of motor 1: Quick mode at time of activation of motor 2: Quick mode only	0
F750	EASY key function selection	0: Quick mode/ standard setting mode switching function 1: Shortcut key: Pressing for 2 sec. to record the parameter, pressing normally to jump to recorded parameter (first jump to the 1st history) 2: Local/remote key: Local by ON 3: Monitor peak minimum hold trigger	0

■ Quick mode/standard setting mode switching function (F750=0)

The EASY key allows you to switch between quick mode and standard setting mode. The way parameters are read out and displayed varies according to the mode selected.

Quick mode

This mode allows you to previously select parameters (max. 32 parameters) whose settings need to be changed frequently and to read them out only. Eight parameters are selected by default; add or remove parameters as required.

Standard setting mode

Standard setting mode in which all parameters are read out.

[How to read out parameters]

To enter the setting monitor mode, set parameter F750 to 0, switch to the setting monitor mode using the EASY key, and then press the MODE key.

Press the Δ key or the ∇ key to read out parameters in ascending or descending order.

The relation between the parameter and the mode selected is shown below.

PSEL = 0

* Standard setting mode at time of activation of motor. Press the EASY key to switch to the quick mode.

PSEL = 1

* Quick mode at time of activation of motor. Press the EASY key to switch to the standard setting mode.

PSEL = 2

* Quick mode (fixed).

5

[How to select parameters]

Select the desired parameters as parameters 1 to 32 ($F 75 1 \sim F 78 2$). Note that parameters should be specified by communication number. For communication numbers, refer to Table of parameters.

In the quick mode, only parameters registered as parameters 1 to 32 are displayed in order of registration.

By default, parameters are set as shown in the table below.

[Parameter setting]

Title	Function	Adjustment range	Default setting
$F 75 1$	Quick registration parameter 1	0~999	40(RU4)
$F 75 2$	Quick registration parameter 2	0~999	15(Pk)
$F 75 3$	Quick registration parameter 3	0~999	11(FH)
$F 75 4$	Quick registration parameter 4	0~999	9(RCC)
$F 75 5$	Quick registration parameter 5	0~999	10(dEL)
$F 75 6$	Quick registration parameter 6	0~999	600(LHR)
$F 75 7$	Quick registration parameter 7	0~999	6(FR)
$F 75 8$	Quick registration parameter 8	0~999	999
~	~		
$F 78 1$	Quick registration parameter 31	0~999	50(PSEL)
$F 78 2$	Quick registration parameter 32		

Note: If any number other than communication numbers is specified, it is regarded as 999 (no function assigned).

Continuous 999: Disabled

■ Shortcut key function ($F 75 0 = 1$)

This function allows you to register, in a shortcut list, parameters whose settings need to be changed frequently so that you can read them out easily in a single operation.

The shortcut is usable in the frequency monitor mode only.

[Operation]

Set the parameter $F 75 0$ to 1, read out the setting of the parameter you want to register, and press and hold down the EASY key for 2 sec. or more. The registration of the parameter in a shortcut list has been completed.

To read out the parameter, just press the EASY key.

■ Local/remote key function (F 750=2)

With this function, the means of starting and stopping operation and setting frequencies can be switched easily between the operation panel and the means selected with the parameters $\mathcal{C} \mathcal{N} \mathcal{D} \mathcal{d}$ (command mode selection) and $F \mathcal{N} \mathcal{D} \mathcal{d}$ (frequency setting mode selection).

To switch between them, set the parameter $F 750$ to 2 and use the EASY key.



Local mode : When Local mode selected by $\mathcal{E} \mathcal{A} \mathcal{S} \mathcal{Y}$ key, start and stop, and frequency setting are effective only by operation panel keys.
The EASY key lamp is lit while Local mode selected.

Remote mode : Start and stop, and frequency setting follow the selection of $\mathcal{C} \mathcal{N} \mathcal{D} \mathcal{d}$ (Command mode),or $F \mathcal{N} \mathcal{D} \mathcal{d}$ (Frequency setting mode).

Setting mode – Switching of commands and references

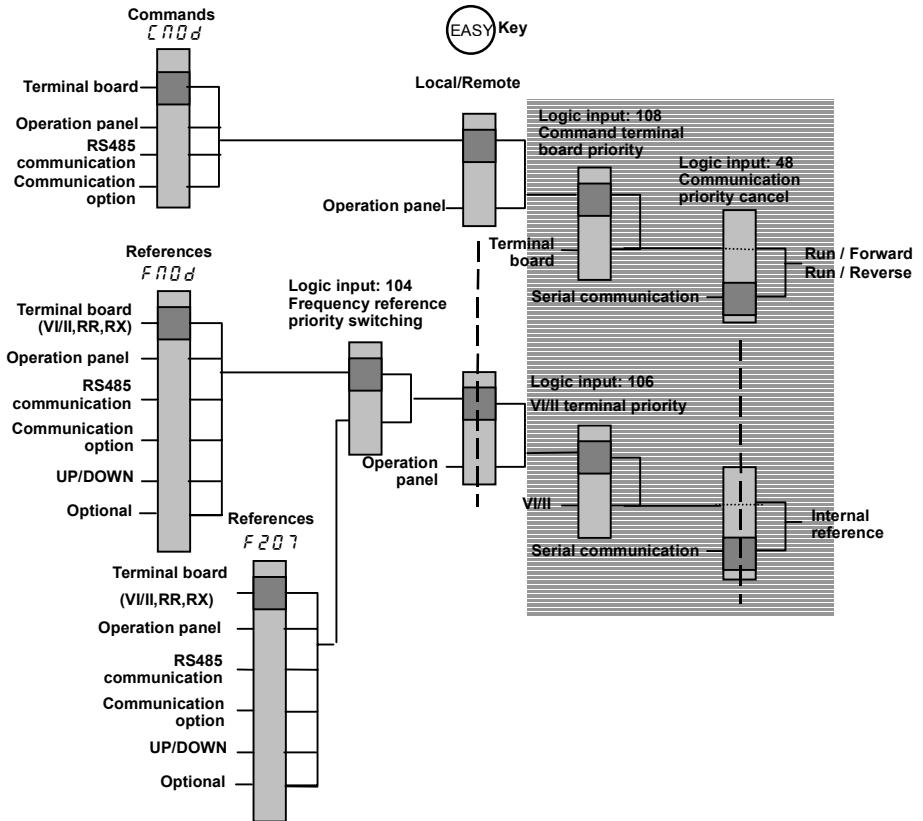

■ Bumpless key function ($F 750=2, F 295=1$)

Setting $F 750$ to 2 (local/remote switching enabled) and $F 295$ to 1 (bumpless operation enabled) enables bumpless operation, which allows seamless switching between local and remote during operation.

⇒ For details, refer to section 6.14.

■ Peak hold function ($F 750=3$)

This function allows you to set peak hold and minimum hold triggers for parameters $F 709, F 966, F 968, F 970$ and $F 972$, using the EASY key. The measurement of the minimum and maximum values set for $F 709, F 966, F 968, F 970$ and $F 972$ starts the instant when you press the EASY key after setting parameter $F 750$ to 3.

The peak hold and minimum hold values are displayed in absolute values.

6. Extended parameters

Extended parameters are provided for sophisticated operation, fine adjustment and other special purposes.
 ⇒ Refer to Section 11, Table of parameters.

6.1 Input/output parameters

6.1.1 Low-speed signal

F 100 : Low-speed signal output frequency

• **Function**
 When the output frequency exceeds the setting of **F 100** an ON signal will be generated. This signal can be used as an electromagnetic brake excitation/release signal.
 ★Through the open collector terminal OUT1 or OUT2 (24Vdc-50mA [max.]).

[Parameter setting]

Title	Function	Adjustment range	Default setting
F 100	Low-speed signal output frequency	0.0~44 Hz	0.0

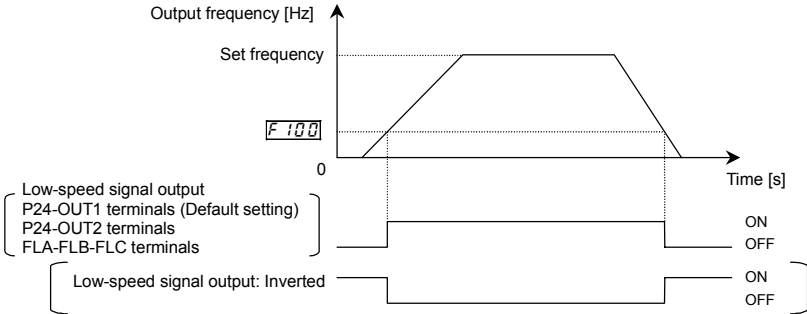

[Connection diagram (Sink logic)]

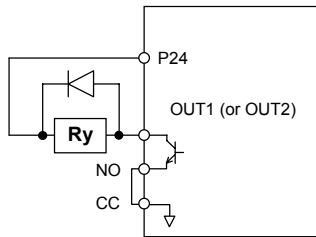

• **Output terminal setting**
 The low-speed signal (ON signal) output function has been assigned to the terminal OUT1 by default. This setting must be changed to invert the polarity of the signal.

[Parameter setting]

Title	Function	Adjustment range	Example of setting
F 130	Output terminal function selection 1(OUT1)	0~255	4 (ON signal) or 5 (OFF signal)

Note: To put out signals to OUT2, select the parameter **F 13 1**.

6.1.2 Putting out signals of arbitrary frequencies

$F 101$: Speed reach setting frequency

$F 102$: Speed reach detection band

• Function
 When the output frequency becomes equal to the frequency set by $F 101 \pm F 102$, an ON or OFF is generated.

[Parameter setting of frequency and detection band]

Title	Function	Adjustment range	Default setting
$F 101$	Speed reach setting frequency	0.0~UL Hz	0.0
$F 102$	Speed reach detection band	0.0~UL Hz	2.5

[Parameter setting of output terminal selection]

Title	Function	Adjustment range	Example of setting
$F 131$	Output terminal function selection 2 (OUT2)	0~255	B(RCH (specified speed ON signal)) or g(RCH (specified speed OFF signal))

Note: To put out signals to OUT1, select the parameter $F 130$.

1) If the detection band value + the set frequency is less than the designated frequency

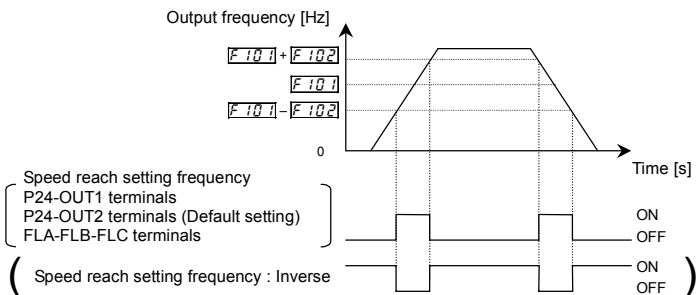

2) If the detection band value + the set frequency is more than the designated frequency

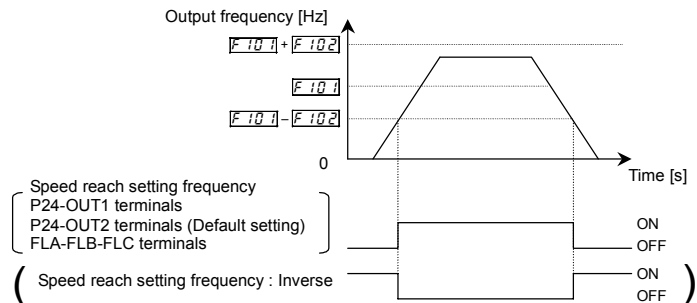

6

6.2 Input signal selection

6.2.1 Priority when forward/reverse run commands are entered simultaneously

F 105 : Priority when forward/reverse run commands are entered simultaneously

• **Function**
 This parameter allows you to select the direction in which the motor runs when a forward run (F) command and a reverse run (R) command are entered simultaneously.
 1) Reverse run
 2) Deceleration stop

[Parameter setting]

Title	Function	Adjustment range	Default setting
F 105	Priority when forward/reverse run commands are entered simultaneously	0:Reverse run, 1:Stop	1

[F 105=0 (Reverse run)] If a F command and a R command are entered simultaneously, **the motor will run in the reverse direction.**

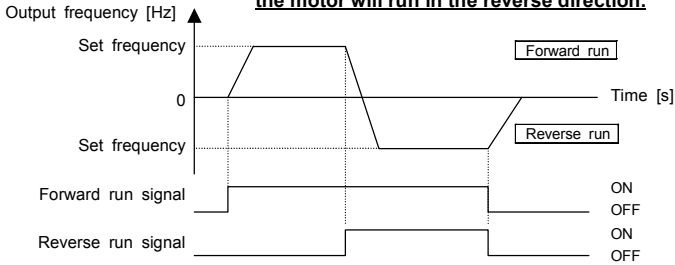

[F 105=1 (Stop)] If a F command and a R command are entered simultaneously, **the motor will slow down to a stop.**

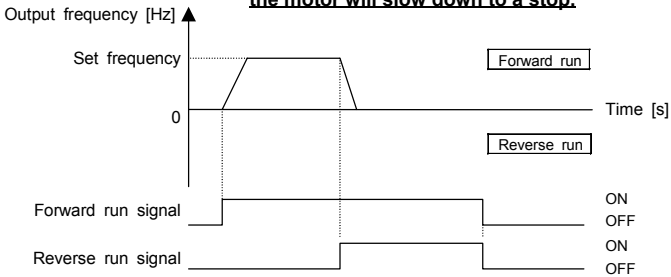

6.2.2 Assigning priority to the terminal board in the operation panel and operation mode

F106 : Input terminal priority selection

• **Function**
 This parameter is used to give priority to certain external commands entered from the terminal board in operation panel and operation mode.
 For example, when jogging the motor by giving signals externally.

[Parameter setting]

Title	Function	Adjustment range	Default setting
F106	Input terminal priority selection	0:Disabled, 1:Enabled	0

[0: Deselect (terminal board has no priority)]

Priority is always given to commands (operation commands) entered from the operation panel. To give priority to commands from the terminal board, it is necessary to switch from control panel operation to terminal board operation by sending signals through the terminal board.

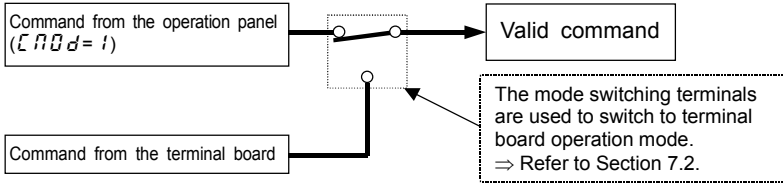

[1: Select (terminal board has priority)]

Priority is given to commands entered from the terminal board even in operation panel operation mode.

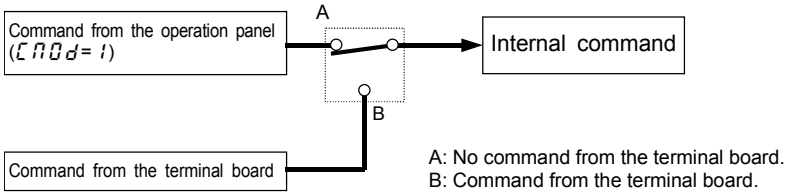

Note: Priority is given to commands entered from the terminal board even if the operation mode is switched from Remote to Local with the Easy key's "local/remote switching" function.

■ Priority command from terminal board (Operation command)

- Jog run : input terminal selection 18/19
- DC braking : input terminal selection 22/23

An example of switching to jog run in operation panel operation mode.

[In case that terminals S3 and CC are assigned to jog run]

Assign control terminal S3 ([14: preset speed 3] in default setting) as the jog run setting terminal.

Title	Function	Adjustment range	Example of setting
F117	Input terminal function selection 7 (S3)	0~135	18 (Jog run setting terminal)

6

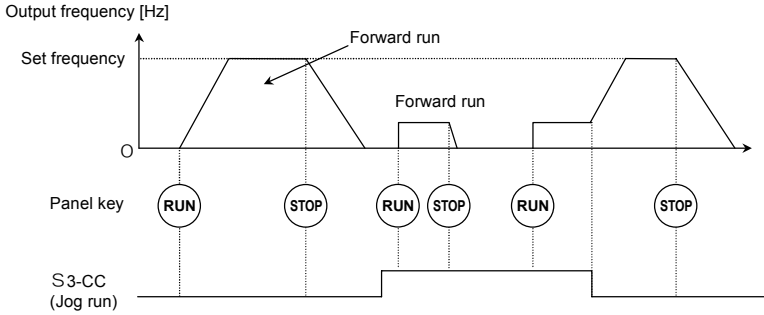

6.2.3 Analog input signal switching

F108 : Analog input VI/VII voltage/current switching

F109 : Analog input AI2 (optional circuit board) voltage/current switching

• **Function**
 These parameters are used to switch signals to be sent to the analog input terminals VI/II and AI2 (optional).

[Parameter setting]

Title	Function	Adjustment range	Example of setting
F108	Analog VI/VII voltage/current switching	0: Voltage input 1: Current input	0
F109	Analog input AI2 (optional circuit board) voltage/current switching	0: Voltage input 1: Current input	0

6

When using the analog input terminal VI/II as a voltage input terminal (VI)
 F108=0

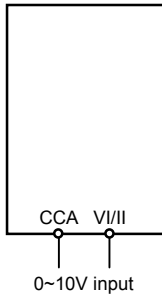

When using the analog input terminal VI/II as a voltage input terminal (II)
 F108=1

CCA: Analog common

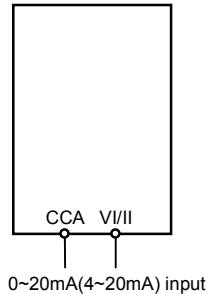

⇒ For an explanation of input gain and bias adjustments, refer to Section 6.23.

■ Connection method

1) a-contact input

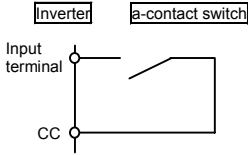

Sink setting

★This function is activated when the input terminal and CC (common) are short-circuited. Use this function to specify forward/reverse run or a preset speed operation.

2) Connection with transistor output

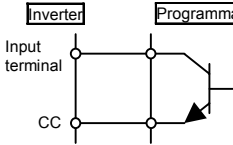

★Operation can be controlled by connecting the input and CC (common) terminals to the output (no-contacts switch) of the programmable controller. Use this function to specify forward/reverse run or a preset speed operation. Use a transistor that operates at 24Vdc/5mA.

* Interface between programmable controller and inverter

Note: When using a programmable controller with open collector outputs for control, connect it to the P24/PLC terminal, as shown in the figure below, to prevent the inverter from malfunctioning because of current flowing in.

Also, be sure to turn the SW1 slide switch to the PLC position.

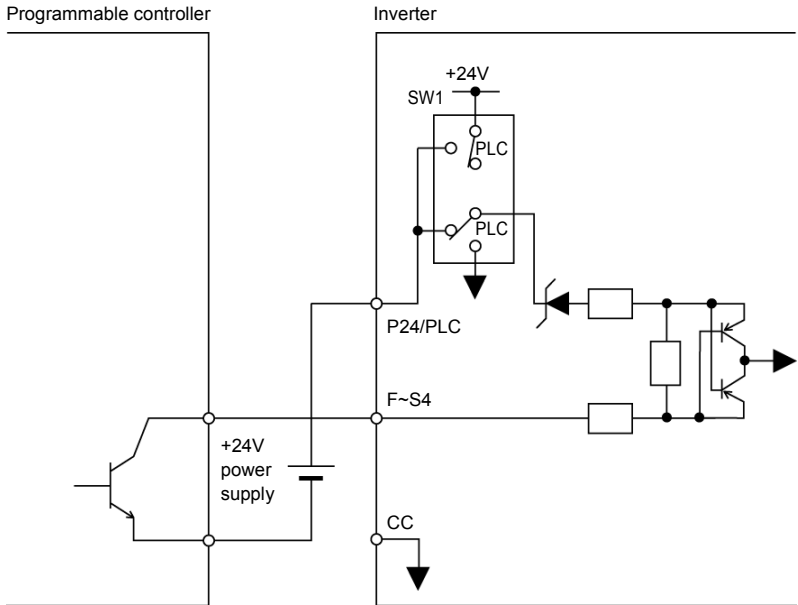

3) Sink logic/source logic input

Sink logic/source logic (input/output terminal logic) switching is possible.

⇒ For details, refer to Section 2.3.2.

6.3.3 Modifying output terminal functions

F 130	:	Output terminal function selection 1 (OUT1)
F 131	:	Output terminal function selection 2 (OUT2)
F 132	:	Output terminal function selection 3 (FL)
F 133	—	F 138 : Output terminal function selection 4~9
F 168	—	F 169 : Output terminal function selection 10, 11

⇒ For details, refer to Section 7.2.2.

6.4 Basic parameters 2

6.4.1 Switching among V/f characteristics 1 and 2 from input terminal

F 170	:	Base frequency 2
F 171	:	Base frequency voltage 2
F 172	:	Manual torque boost 2
F 173	:	Thermal protection level 2

• Function

Use the above parameters to switch the operation of 2 motors with a single inverter and to select motor V/f characteristics (1 to 2) according to the particular needs or operation mode.

[Switching methods]

Terminals are used for this switching.

Note: The setting of parameter $P \tau$ (V/f control mode selection) is valid only when V/f1 is selected. If V/f2 is selected, V/f control is performed in constant torque mode. Do not switch motors when the parameter

$P \tau$ (V/f control mode selection) is set at 7. For parameters selected when changing V/f characteristics (1 to 2), refer to table on the next page.

Note: Refer to Section 5.8 $\omega \tau$ (Base frequency 1) for F 170,

Section 5.8 $\omega \tau \omega$ (Base frequency voltage 1) for F 171,

Section 5.7 ωb (Manual torque boost) for F 172,

and Section 5.14 $\tau H \tau$ (Motor electronic thermal protection level 1) for F 173, respectively.

■ Setting of switching terminals

The V/f1 and V/f2 switching function is not yet assigned to any terminal. Therefore, it is necessary to assign them to unused terminals.

Ex.) Assigning the V/f switching 1 function to S1.

Title	Function	Adjustment range	Example of setting
F 1 15	Input terminal function selection 5 (S1)	0 ~ 135	28 (V/f switching 1)

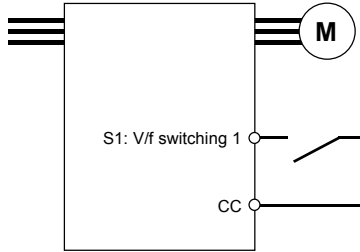

S1-CC	V/f	Parameters selected
OFF	1	Base frequency 1 : uL Base frequency voltage 1 : uLv Manual torque boost 1 : ub Thermal protection 1 : tHr
ON	2	Base frequency 2 : F 170 Base frequency voltage 2 : F 171 Manual torque boost 2 : F 172 Thermal protection 2 : F 173

★ Select V/f1 when using the vector control and the V/f-5 point setting.
Selecting V/f2, disables vector control but enables the V/f constant control.

★ By using "My function," torque limits and acceleration/deceleration modes can be switched along with V/f switching.

Note: With the operation panel or communication, the panel acceleration/deceleration selection (F 5 0 4) can be set.

* This function is active only in operation panel operation mode.

6.5 V/f 5-point setting

F190	: V/f 5-point setting VF1 frequency	F196	: V/f 5-point setting VF4 frequency
F191	: V/f 5-point setting VF1 voltage	F197	: V/f 5-point setting VF4 voltage
F192	: V/f 5-point setting VF2 frequency	F198	: V/f 5-point setting VF5 frequency
F193	: V/f 5-point setting VF2 voltage	F199	: V/f 5-point setting VF5 voltage
F194	: V/f 5-point setting VF3 frequency		
F195	: V/f 5-point setting VF3 voltage		

⇒ For details, refer to Section 5.6,5).

6.6 Speed command switching

6.6.1 Using two types of frequency (speed) commands

F00d	: Frequency setting mode selection 1
F200	: Frequency priority selection
F207	: Frequency setting mode selection 2
F208	: Speed command priority switching frequency

• Function

- These parameters switch two types of frequencies
- Automatic switching by parameter setting
- Automatic switching by means of switching frequencies
- Switching with input terminal

1) Switching with input terminal board (F200=0)

Reference can be switched if the frequency priority switching function is assigned to a terminal.

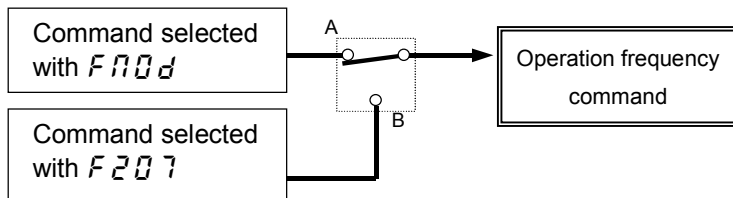

A : Selects the command set with parameter F00d. – Operation frequency command switching terminal OFF

B : Selects the command set with parameter F207. – Operation frequency command switching terminal ON

Ex.) When the frequency priority switching function is assigned to terminal S3.

Title	Function	Adjustment range	Example of setting
F117	Input terminal function selection 7 (S3)	0~135	104 (Operation frequency command switching)

		Speed command	
	OFF	Command selected with F00d	
	ON	Command selected with F207	

2) Automatic switching by means of switching frequencies ($F200 = 1$)

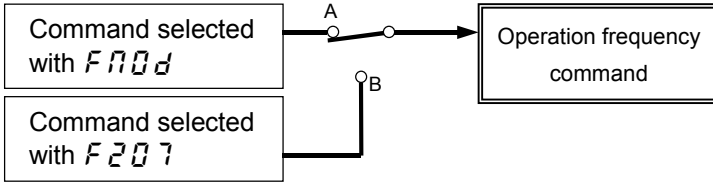

- A: If the frequency set with Fnd is higher than that set with $F208$ Priority is given to the command set with Fnd .
- B: If the frequency set with Fnd is equal to or lower than that set with $F208$ Priority is given to the command set with $F207$.

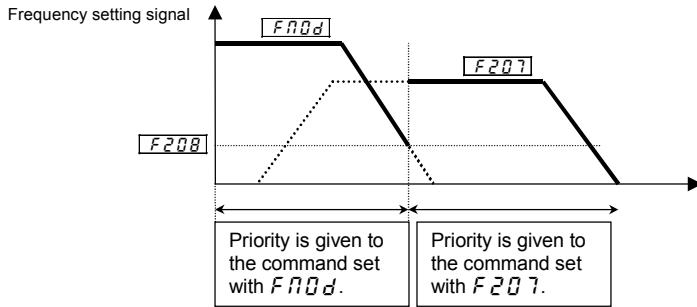

[Parameter setting]

Title	Function	Adjustment range	Default setting
Fnd	Frequency setting mode selection 1	1:V/I (voltage/current input) 2:RR/S4 (potentiometer/voltage input) 3:RX (voltage input) 4:Operation panel input enabled (including LED/LCD option input) 5:2-wire RS485 communication input 6:4-wire RS485 communication input 7:Communications option input 8:Optional AI1 (differential current input) 9:Optional AI2 (voltage/current input) 10:Up/Down frequency 11:Optional RP pulse input 12:Optional high-speed pulse input	2
$F208$	Frequency priority selection	0: Fnd / $F207$ terminal switching (input terminal function selection 104, 105) 1: Fnd / $F207$ frequency switching (switching with $F208$)	0
$F207$	Frequency setting mode selection 2	Same as Fnd (1~12)	1
$F208$	Speed command priority switching frequency	0.1~FH Hz	0.1

6.7 Operation frequency

6.7.1 Start frequency/Stop frequency

F240 : Start frequency setting

F243 : Stop frequency setting

• Function

The frequency set with the parameter **F240** is put out as soon as operation is started. Use the **F240** parameter when a delay in response of starting torque according to the acceleration/deceleration time is probably affecting operation. Setting the starting frequency to a value from 0.5 to 2.0Hz (max. 5Hz) is recommended. The occurrence of an overcurrent can be suppressed by setting this frequency below the rated slippage of the motor. If 0 speed torque is needed ($P\tau = 7$), set **F240**, **F243** at 0.0Hz.

- At start up : frequency set with **F240** is put out immediately.
- At stop : The output frequency drops to 0Hz immediately by the frequency set with **F243**.

[Parameter setting]

Title	Function	Adjustment range	Default setting
F240	Starting frequency setting	0.0~10.0 Hz	0.1
F243	Stop frequency setting	0.0~30.0 Hz	0.0

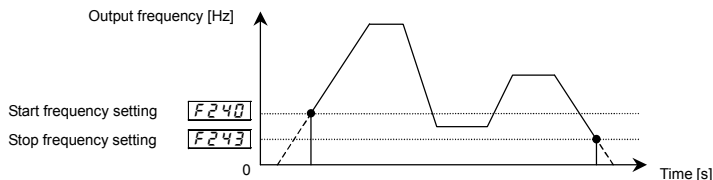

Note: Set these parameters so that the start frequency **F240** is higher than the stop frequency **F243**.
 If the **F240**-set frequency is lower than the **F243**-set frequency, the reference frequency must be higher than the **F243**-set frequency to start the motor.
 If both **F240** and **F243** are set to 0.0 Hz, the motor will start even if the frequency set is 0.0Hz.

6.7.2 Run/Stop control with frequency setting signals

F241 : Operation start frequency

F242 : Operation start frequency hysteresis

• Function

The Run/Stop of operation can be controlled simply with frequency setting signals.

[Parameter setting]

Title	Function	Adjustment range	Default setting
F241	Operation starting frequency	0.0~FH	0.0
F242	Operation starting frequency hysteresis	0.0~30.0 Hz	0.0

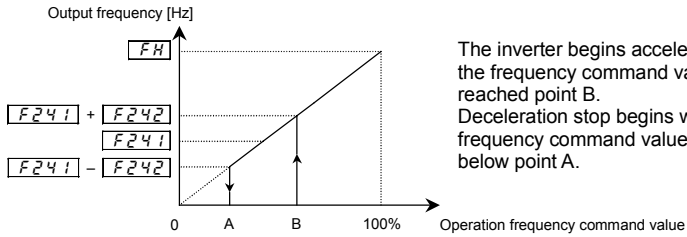

The inverter begins accelerating after the frequency command value has reached point B. Deceleration stop begins when the frequency command value decreases below point A.

6.7.3. Frequency setting signal 0Hz dead zone handling function

$F244$: Frequency command dead band

• **Function**

If the frequency is set to 0Hz by means of an analog signal so that the motor shaft can be locked by sensor vector control ($P\epsilon = 7$) the frequency may not always be 0Hz because of drift or offset. In such a case, this parameter allows you to correctly set the operation frequency command to 0Hz. If the operation frequency command is below the frequency setting signal 0Hz insensitive frequency set with $F244$, parameter $F244$ will adjust the operation frequency command to 0Hz.

[Parameter setting]

Title	Function	Adjustment range	Default setting
$F244$	Frequency command dead band	0.0~5.0 Hz	0.0

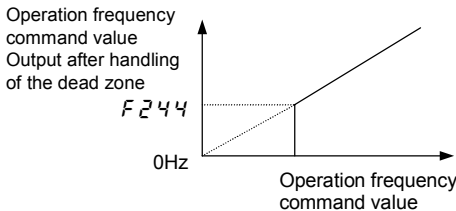

Note 1: This function is invalid to preset the speed operation frequency command.

Note 2: It is effective as frequency instruction is to the frequency reference chosen by $F70d$, $F207$, communication, etc.

Note 3: The addition and multiplication of the override function is carried out to the frequency in which this function operated.

6.8 DC braking

6.8.1 DC braking

$F250$: DC braking start frequency

$F252$: DC braking time

$F251$: DC braking current

$F253$: Forward/reverse DC braking priority control

• **Function**

A large braking torque can be obtained by applying a direct current to the motor. These parameters set the direct current applied to the motor, the application time and the start frequency.

[Parameter setting]

Title	Function	Adjustment range	Default setting
$F250$	DC braking start frequency	0.0~120.0 Hz	0.0
$F251$	DC braking current	0~100 %	50
$F252$	DC braking time	0.0~200.0 sec.	1.0
$F253$	Forward/reverse DC braking priority control	0:Disabled, 1:Enabled	0

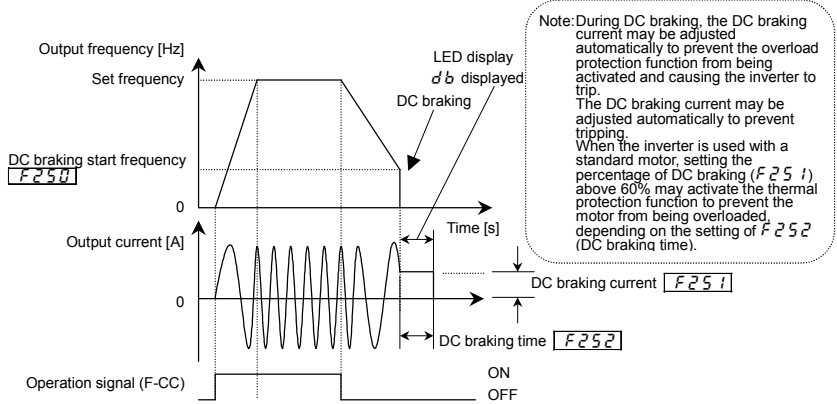

<DC braking start conditions>

The forward/reverse DC braking priority control function F253 recognizes certain conditions such as stop commands from the inverter, and is activated when the output frequency goes down below the DC braking start frequency set with F250. In this case, the conditions under which DC braking starts include not only the issue of a start or stop command from the operation panel or an external input device, but also a fall in the reference frequency below the value set with F243 (stop frequency setting) or a fall in the output frequency below the operation stop frequency setting F243.

[DC braking under normal conditions] (Forward/reverse run DC braking priority control F253=0 [Disabled])

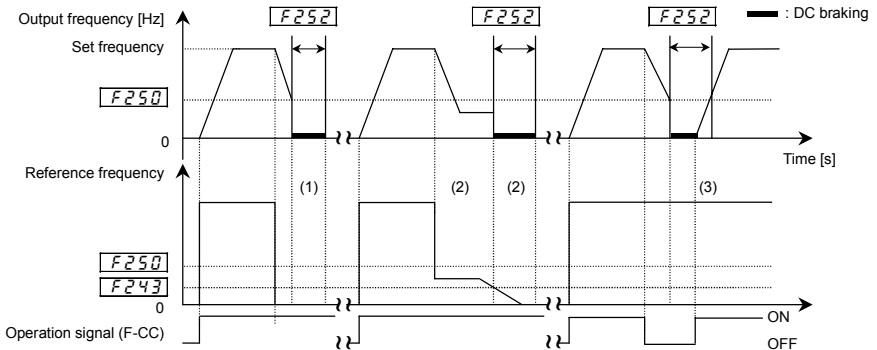

- (1) If F250 and F243 > reference frequency : DC braking
- (2) If F250 > reference frequency > F243 : Operation at the command frequency
- If F250 and F243 > reference frequency : DC braking
- (3) If an operation command is entered during DC braking : DC braking is discontinued to restart the operation.

6

[Priority to DC braking during forward/reverse operation] (Forward/reverse run DC braking priority control
 $F253=1$ [Enabled])

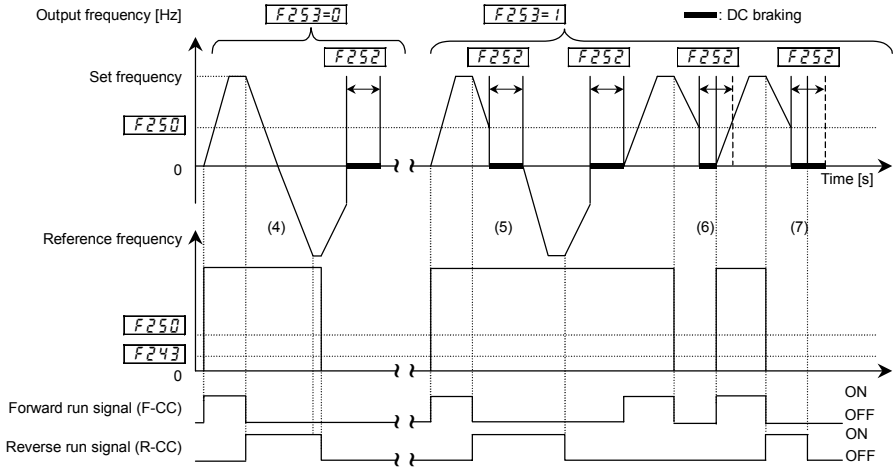

- (4) During normal forward/reverse run ($F253=0$) : Not recognized as a stop command, so that the DC braking is not active.
- (5) If a reverse run (or forward) command is entered during forward run (or reverse) ($F253=1$) : DC braking when the frequency set with $F250$ decreases below the reference frequency during deceleration.
- (6) If an operation command is entered during DC braking : RUN command has a priority.
- (7) If an operation command is changed from ON to OFF during DC braking, DC braking is discontinued to stop the operation.

6

6.8.2 Motor shaft fixing control

$F254$: Motor shaft fixing control

• Function
 This function is used to prevent the motor from running unexpectedly after the motor is stopped because its shaft is not restrained or to preheat the motor.

[Parameter setting]

Title	Function	Adjustment range	Default setting
$F254$	Motor shaft fixing control	0:Disabled, 1:Enabled	0

If the motor shaft fixing control parameter $F254$ is set at 1, DC braking continue at half a braking rate of that set with $F251$ to retain the motor after it has come to a full stop by DC braking. To discontinue motor shaft axis fixing control, cancel the assignment of the input terminal function "ST standby command (6)" to an input terminal. Note, however, that this function doesn't operate after a DC braking command is entered by control input terminal signal.

When assigning the ST function to the S3 terminal.

Title	Function	Adjustment range	Default setting
$F110$	Always ON function selection 1	0~135	0
$F117$	Input terminal function selection 7 (S3)	0~135	6

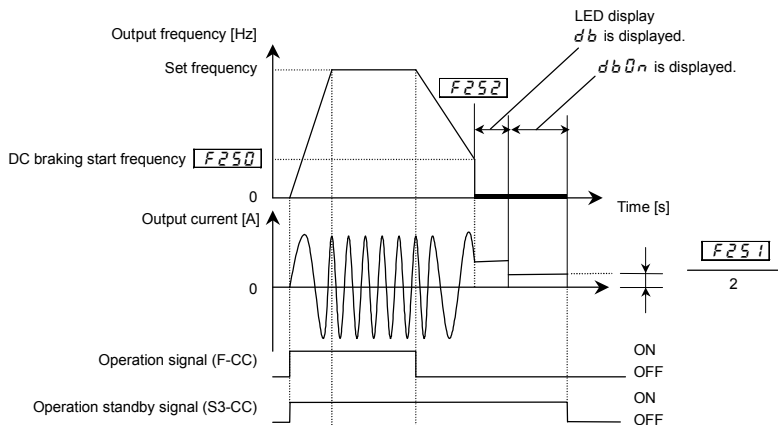

Note 1: If the motor shaft fixing control parameter F 2 5 4 is set at 1 (enabled) when the output frequency is below the DC braking start frequency F 2 5 0 and terminals S3-CC are closed (ON), the DC braking function is activated and the motor shaft fixing control continues regardless of the setting of the DC braking time parameter F 2 5 2.

Note 2: If a power failure occurs during motor shaft fixing control and the motor starts to a coast, motor shaft fixing control will be canceled. Also, if the inverter trips during motor shaft fixing control and is restored to working order by the retry function, motor shaft fixing control will be canceled.

6.8.3 Function of issuing a 0Hz command during a halt

F 2 5 5 : 0Hz command output selection

• Function

This function controls the motor in the zero-speed state at the time of stop. If this function is set up, the 0Hz command will be put out instead of DC braking at the time of a stop, and a motor will be controlled in the setting time stop state. The monitor display serves as db during this control operation. This function operates only at the time of vector control with a sensor (P 2 = 7). Refer to DC braking (Section 6.8.1) for conditions of operation. The position of DC braking is served as an operation which sets the operation frequency command to 0Hz.

[Parameter setting]

Title	Function	Adjustment range	Default setting
F 2 5 5	0Hz command output selection	0: Standard (DC braking) 1: 0Hz command	0
F 2 5 0	DC braking starting frequency	0.0~120.0 Hz	0.0
F 2 5 2	DC braking time	0.0~20.0 sec.	1.0

Note 1: This function doesn't operate when F 2 5 0 = 0.0.

Note 2: If this function is set up, motor shaft fixing control F 2 5 4 cannot be used.

Note 3: This function doesn't operate except P 2 = 7 of the vector control mode with a sensor. In order to use this function, the option board for PG feedback is required. Other than the vector control with a sensor P 2 = 7, the usual DC braking operates.

Note 4: Since the reference frequency that will suspend the motor abruptly from the state of high rotation if (F 2 5 0) is set up highly, please be careful. A trip may occur according to load conditions.

Note 5: This parameter has a function similar to the DC braking function, which is activated by a command from the terminal board or an external control device (input terminal function 2 2 or 2 3, or command from external control device). To the DC braking function which will be activated if F 2 5 1 (jog run stop pattern) is set to 2 (DC braking), and to the DC braking function which will be activated if F 5 0 3 (emergency stop pattern) is set to 2 (DC braking), but it issues 0Hz commands instead of DC braking commands.

6.9 Auto-stop in case of lower-limit frequency continuous operation (Sleep/Wake-up function)

F256 : Time limit for lower-limit frequency operation

• Function
 If operation is carried out continuously at a frequency below the lower-limit frequency ($L L$) for the period time set $F 2 5 6$, the inverter will automatically slow down the motor to a stop.
 “ $L L P$ ” is always displayed on the operation panel. (Blinking alternately)
 The auto-stop function will be disabled when the frequency command value reaches over the lower limit frequency ($L L$)+0.2Hz or the operation command is turned off.

[Parameter setting]

Title	Function	Adjustment range	Default setting
F256	Auto-stop in case of lower-limit frequency continuous operation	0.0:None 0.1~600.0 sec.	0.0

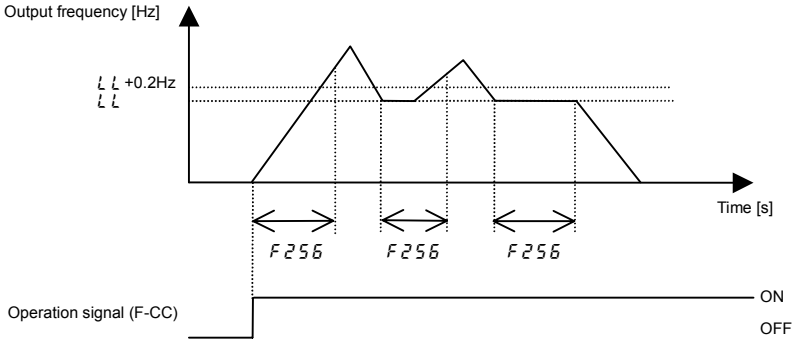

Note: This function is enabled even at the start of operation and during switching between forward and reverse run.

6.10 Jog run mode

- F260** : Jog run frequency
- F261** : Jog run stop pattern
- F262** : Operation panel jog run mode

• Function
 Use the jog run parameters to operate the motor in jog mode. Input of a jog run signal generates a jog run frequency output at once, irrespective of the designated acceleration time.
 Also, you can choose an operation panel start/stop mode between the ordinary start/stop mode and the jog run start/stop mode.

The jog run function needs to be assigned to an input terminal.
 When assigning it to the S3 terminal, set F117 to 18.
 The motor can be operated in jog run mode while the jog run setting terminals are connected (S3-CC: ON).

[Parameter setting]

Title	Function	Adjustment range	Default setting
F260	Jog run frequency	F240~20.0 Hz	5.0
F261	Jog run stop pattern	0:Deceleration stop, 1:Coast stop, 2:DC braking stop	0
F262	Operation panel jog run mode	0:Disabled, 1:Operation panel jog run mode enabled	0

<Examples of jog run>

- S3-CC (JOG) ON + F-CC ON: Forward jog run**
- S3-CC (JOG) ON + R-CC ON: Reverse jog run**
- (Normal operation frequency signal input + F-CC ON: Forward run, Normal operation frequency signal input + R-CC ON: Reverse run)**

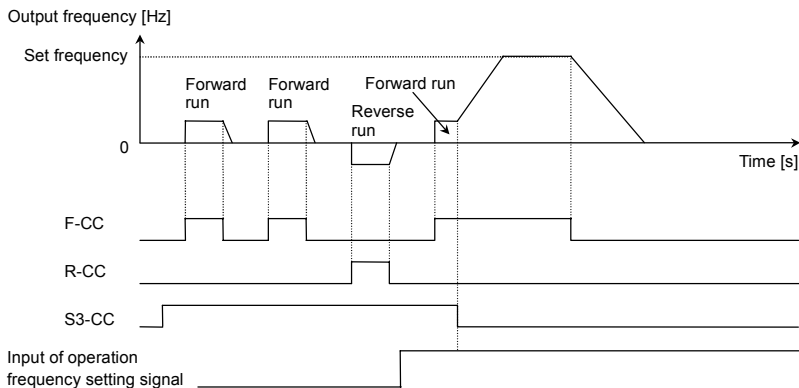

- The jog run setting terminal (S3-CC) is enabled when the operation frequency is below the jog run frequency. This connection does not function at an operation frequency exceeding the jog run frequency.
- The motor can be operated in jog mode while the jog run setting terminals are connected (S3-CC: ON).
- Jog run has priority, even when a new operation command is given during operation.
- Even during panel operation (C100d = 1), the inverter can be switched forcibly to jog run mode by turning on or off the input terminal if parameter F105 (input terminal priority selection) is set to 1 and the jog run setting function (18, 19) is assigned to the input terminal.
- Even for F261=0 or 1, an emergency DC braking becomes enabled when setting F603=2.
- If a forward run command and a reverse run command are entered simultaneously while F105 (priority selection (both F-CC and R-CC are ON)) is set to 0 (reverse run), operation modes are switched as follows: forward jog run → deceleration stop (jog frequency → 0Hz) → reverse jog run. Keep this in mind.
- The jog frequency is not restricted by the upper limit frequency (UL).

[Setting of jog run setting terminal (S3-CC)]

Assign control terminal S3 ([14: preset speed 3] in default setting) as the jog run setting terminal.

Title	Function	Adjustment range	Example of setting
F117	Input terminal function selection 7 (S3)	0~135	18 (Jog run setting terminal)

Note: During the jog run mode, there is LOW (low speed detection signal) output but no RCH (designated frequency reach signal) output, and PID control does not work.

- When the inverter is in panel jog mode, pressing the \wedge key displays F J O G, while pressing the \vee key displays r J O G.
- When F J O G is displayed, the inverter will be placed in forward jog run mode as long as the **RUN** key is held down.
- When r J O G is displayed, the inverter will be placed in reverse jog run mode as long as the **RUN** key is held down.
- During jog run, the direction of rotation can be changed using the \wedge and \vee keys. Press the \wedge key to run the motor in the forward direction, or press the \vee key to run it in the reverse direction.
- If you press and hold down the **RUN** key for 20 seconds or more, the key failure alarm "E - 17" will be displayed.

The figure below shows the relationship between the operation panel jog run mode and each of the other modes.

Pressing the **MODE** key, which will move the inverter through each of the modes.

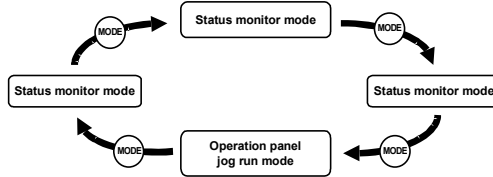

Note1: When the inverter is in operation (RUN key lamp is lit) or when an operation command is issued (RUN key lamp is lit), the inverter cannot be switched to operation panel jog run mode.

Note 2: When parameter F105 (input terminal priority selection) is set to 1, the inverter does not display any message saying that it is in panel jog run mode.

6.11 Setting frequency via external contact input (Up/Down frequency setting)

- F264** : Input from external contacts - Up response time
- F265** : Input from external contacts - Up frequency step
- F266** : Input from external contacts - Down response time
- F267** : Input from external contacts - Down frequency step
- F268** : Initial Up/Down frequency
- F269** : Initial Up/Down frequency rewriting

• **Function**
 These parameters are used to set the output frequency by means of a contact signal from the external control device.

[Parameter setting]

Title	Function	Adjustment range	Default setting
F264	Input from external contacts - Up response time	0.0 ~ 10.0 s	0.1
F265	Input from external contacts - Up frequency step	0.0 ~ FH Hz	0.1
F266	Input from external contacts - Down response time	0.0 ~ 10.0 s	0.1
F267	Input from external contacts - Down frequency step	0.0 ~ FH Hz	0.1
F268	Initial Up/Down frequency	LL ~ UL Hz	0.0
F269	Initial Up/Down frequency rewriting	0: Not changed 1: Setting of F268 changed when power is turned off.	1

★ These functions are operative when parameter F104 (frequency setting mode selection 1) is set to 10 or parameter F207 (frequency setting mode selection 2) is set to 10.

■ Adjustment with continuous signals (Parameter setting example 1)

Set parameters as follows to adjust the output frequency up or down in proportion to the frequency adjustment signal input time:

$$\text{Panel frequency incremental gradient} = F255 / F254 \text{ setting time}$$

$$\text{Panel frequency decremental gradient} = F257 / F256 \text{ setting time}$$

Set parameters as follows to adjust the output frequency up or down almost in synchronization with the adjustment by the panel frequency command:

$$F254 = F256 = 1$$

$$(RCC \text{ (or } F500) / FH) \leq (F255 / F254 \text{ setting time)}$$

$$(dEC \text{ (or } F501) / FH) \leq (F257 / F256 \text{ setting time)}$$

«Sample sequence diagram 1: Adjustment with continuous signals»

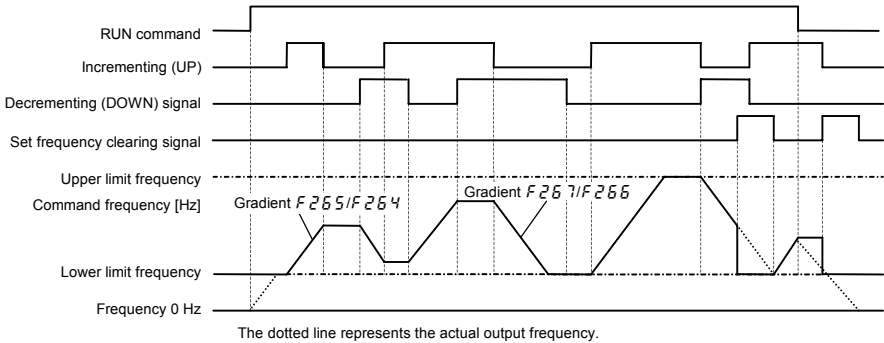

■ Adjustment with pulse signals (Parameter-setting example 2)

Set parameters as follows to adjust the frequency in steps of one pulse:

$$F254, F256 \leq \text{Pulse ON time}$$

$$F255, F257 = 1 \text{ Frequency obtained with each pulse}$$

* The inverter does not respond to any pulses with an ON time shorter than set with $F254$ or $F256$. 12ms or more of clearing signal is allowed.

«Sample sequence diagram 2: Adjustment with pulse signals»

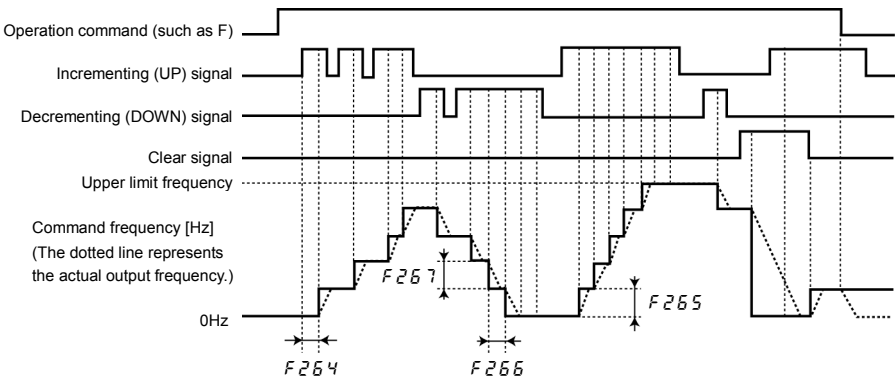

■ **If two signals are input simultaneously**

- If a clear signal and an up or down signal are input simultaneously, priority will be given to the clear signal.
- If up and down signals are input simultaneously, the frequency will be increased or reduced by the difference between the settings of $F 2 6 5$ and $F 2 6 7$. For example, if the $F 2 6 5$ setting is larger, the frequency will be increased by the value obtained by subtracting the setting of $F 2 6 5$ from that of $F 2 6 7$.

■ **Setting of the initial Up/Down frequency**

To adjust the frequency start at a specified frequency other than 0.0 Hz (default initial frequency) after turning on the inverter, specify the desired frequency using $F 2 6 8$ (initial Up/Down frequency).

■ **Change of the initial Up/Down frequency**

To make the inverter automatically save the frequency immediately before it is turned off and start operation at that frequency next time power is turned on, set $F 2 6 9$ (change of initial Up/Down frequency) to i (which changes the setting of $F 2 6 8$ when power is turned off).

Keep in mind that the setting of $F 2 6 8$ is changed each time power is turned off.

■ **Frequency adjustment range**

The frequency can be set from 0.0 Hz to $F H$ (Maximum frequency). The lower limit frequency will be set as soon as the set frequency clearing function (function number $9 2, 9 3$) is entered from the input terminal.

■ **Minimum unit of frequency adjustment**

If $F 7 0 2$ (Frequency free unit magnification) is set to $1.0 0$, the output frequency can be adjusted in steps of 0.01Hz.

6.12 Jump frequency - jumping resonant frequencies

- $F 2 7 0$: Jump frequency 1
- $F 2 7 1$: Jumping width 1
- $F 2 7 2$: Jump frequency 2
- $F 2 7 3$: Jumping width 2
- $F 2 7 4$: Jump frequency 3
- $F 2 7 5$: Jumping width 3

• **Function**

Resonance due to the natural frequency of the mechanical system can be avoided by jumping the resonant frequency during operation. During jumping, hysteresis characteristics with respect to the jump frequency are given to the motor.

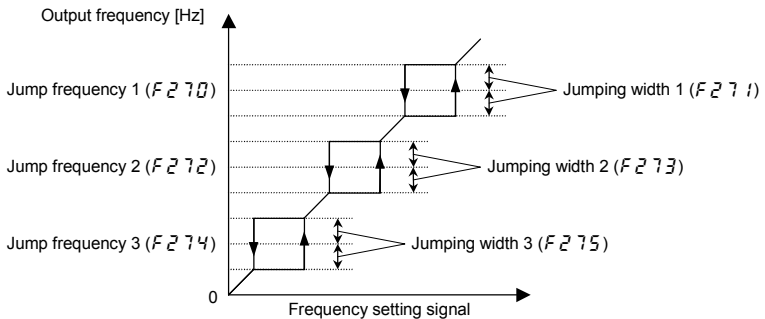

[Parameter setting]

Title	Function	Adjustment range	Default setting
F270	Jump frequency 1	0.0~FH Hz	0.0
F271	Jumping width 1	0.0~30.0 Hz	0.0
F272	Jump frequency 2	0.0~FH Hz	0.0
F273	Jumping width 2	0.0~30.0 Hz	0.0
F274	Jump frequency 3	0.0~FH Hz	0.0
F275	Jumping width 3	0.0~30.0 Hz	0.0

★If the upper limit frequency (UL) is within jump frequency range, it is limited to the lowest frequency in the jump frequency range.

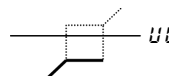

★If the lower limit frequency (LL) is within jump frequency range, it is limited to the highest frequency in the jump frequency range.

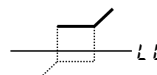

★Do not overlap upper limit frequency (UL) and lower limit frequency (LL) within jump frequency range.

If they are overlapped, it is operated lowest jump frequency.

★Do not overlap two or more jump frequency ranges, or it cannot be operated within normal range.

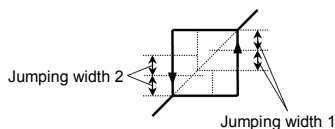

★During acceleration or deceleration, the jumping function is disabled for the operation frequency.

6.13 Preset speed operation frequencies

6.13.1 Preset speed operation frequency 8 to 15

F287 → **F294** : Preset speed operation frequencies 8 to 15

⇒ For details, refer to Section 5.12.

6.13.2 Forced operation control

F294 : Preset speed operation frequency 15 (Forced operation frequency)

⇒ For details, refer to Section 6.27.

6.14 Bumpless operation

F295: Bumpless operation selection

• **Function**
 When switching from Remote mode to Local mode using **EASY** key, the status of start and stop, and operating frequency at Remote mode are Local mode.
 By contraries, when switching from Local mode to Remote mode, they are not moved to Remote mode.

[Parameter setting]

Title	Function	Adjustment range	Default setting
F295	Bumpless operation selection	0: Disabled 1: Enabled	1

To changeover the Local mode/Remote mode by **EASY** key action, please be sure to set the parameter F295 to 2.
 ⇒ For details, refer to Section 5.22.

Example) Remote mode (L R d:0 (Terminal board))

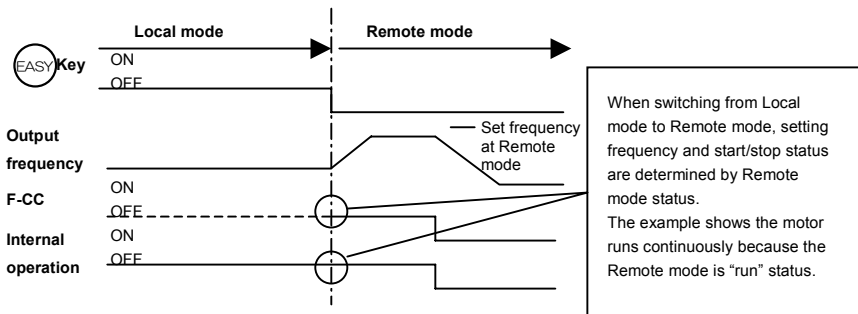
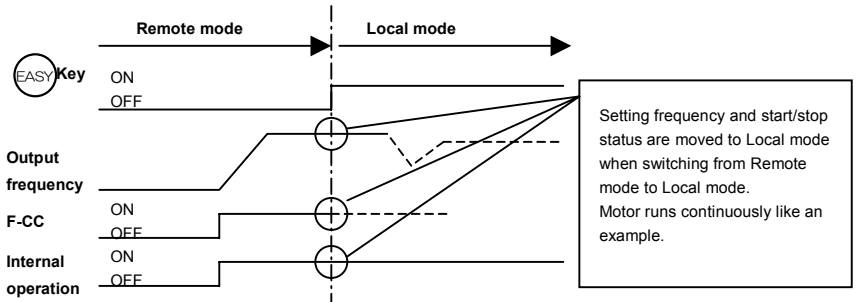

To prevent from moving the setting frequency and start/stop status of Remote mode to Local mode, the F295 is set to "0" (Disabled). In this case, **EASY** key is effective only while stopping.



Note 1: The frequency command value in Local mode and the setting of the parameter F_r (reverse/forward run switching in Local mode) are rewritten as a result of bumpless operation, but they are rewritten just temporarily and they are reset to their original settings if the power is turned off.

Note 2: When the operation mode is switched from Remote mode to Local mode by bumpless operation during deceleration when the F terminal is not ON, the frequency command is not switched and the motor keeps decelerating.

6.15 Trip-less intensification

6.15.1 Retry function

F303 : Retry selection (selecting the no. of times)

 Warning	
 Mandatory	<ul style="list-style-type: none"> • Stand clear of motors and equipment. The motor and equipment stop when the alarm is given, selection of the retry function will restart them suddenly after the specified time has elapsed. This could result in unexpected injury. • Take measures for safety, e.g. attach a cover to the motor, to prevent accidents if the motor suddenly restarts.

• **Function**
This parameter resets the inverter automatically when the inverter gives a trip. During the retry mode, the motor speed search function operated automatically as required and thus allows smooth motor restarting.

[Parameter setting]

Title	Function	Adjustment range	Default setting
F303	Retry selection (selecting the no. of times)	0: Deselect, 1~10 times	0

The likely causes of tripping and the corresponding retry processes are listed below.

Cause of tripping	Retry process	Canceling conditions
Momentary power failure Overcurrent Overvoltage Overload	Up to 10 times in succession 1st retry : About 1 sec after tripping 2nd retry : About 2 sec after tripping 3rd retry : About 3 sec after tripping ... 10th retry : About 10 sec. after tripping	The retry function will be canceled at once if tripping is caused by an unusual event other than momentary power failure, overcurrent, overvoltage or overload. This function will also be canceled if a retry is not successful within the specified number of times.

Trips covered by the retry function

<ul style="list-style-type: none"> • OC 1, 2, 3 : Overcurrent • OC 1P, 2P, 3P : Overcurrent in DC section or overheating of devices • OP 1, 2, 3 : Overvoltage 	<ul style="list-style-type: none"> • OL 1: Inverter overload • OL 2: Motor overload • OL r: Braking resistor overload 	<ul style="list-style-type: none"> • OH : Overheat • SOUL: PM motor step-out
--	---	--

★The retry function is disabled in the following unusual events:

- | | |
|--|--|
| <ul style="list-style-type: none"> • OC R 1, 2, 3: Arm overcurrent at start-up • EPH 1 : Input phase failure • EPH 0 : Output phase failure • OC L : Loaded side overcurrent at start time • OH 2 : External thermal error • UC : Low current operation • UP 1 : Undervoltage • OL t : Overtorque • EF 1, EF 2 : Ground fault • E : Emergency stop | <ul style="list-style-type: none"> • EEP 1, 2, 3: EEPROM error • Err 2 : Main RAM error • Err 3 : Main ROM error • Err 4 : CPU trip • Err 5 : Communication time-out error • Err 6 : Gate array fault • Err 7 : Output current detector error • Err 8 : Optional unit error • E-10~26 • Others (Other than trips covered by the retry function) |
|--|--|

★Protective operation detection relay signals (FLA, FLB, FLC terminal signals) are not sent during use of the retry function. (factory default setting)

★A virtual cooling time is provided for overload tripping (**OL 1, OL 2, OL r**).

⇒ See Section 13.2 for the virtual cooling time.

In this case, the retry function operates after the virtual cooling time and retry time.

★In the event of overvoltage tripping (**OP 1~OP 3**), re-tripping may result unless the DC voltage decreases below a predetermined level.

★In the event of overheating-caused tripping (**OH**), re-tripping may result unless the internal temperature decreases below a predetermined level, since the internal temperature detection function of the inverter works.

- ★Even when trip retention selection parameter (F602) is set to 1, the retry function is enabled by F303 setting.
- ★During retry the blinking display will alternate between r t 3 and the monitor display specified by parameter monitor display selection parameter F710.
- ★The number of retries will be cleared if the inverter is not tripped for the specified period of time after a successful retry.
"A successful retry" means that the inverter output frequency reaches the command frequency without causing the inverter to re-trip.
- ★At the occurrence of a trip, the rotational speed of the motor is measured and, after the motor is restarted, it's speed is regulated to the speed measured.

6.15.2 Avoiding overvoltage tripping

F305 : Overvoltage limit operation **F626** : Overvoltage limit operation level
F319 : Regenerative over-excitation upper limit

• Function
 These parameters are used to automatically control the output frequency and prevent the motor from tripping because of overvoltage due to a rise in the voltage in the DC section during deceleration or constant speed operation. Note that the deceleration time may be prolonged when the overvoltage limiting function is activated.

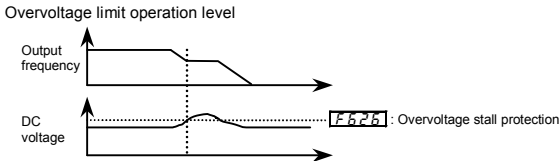

[Parameter setting]

Title	Function	Adjustment range	Default setting
F305	Overvoltage limit operation	0: Enabled 1: Disabled 2: Enabled (quick deceleration) 3: Enabled (dynamic quick deceleration)	2
F319	Regenerative over-excitation upper limit	100~150 % [Note]	140
F626	Overvoltage limit operation level	100~150 % [Note]	134

- Note: 100% corresponds to an input voltage of 200V for 200V models or to an input voltage of 400V for 400V models.
- ★ If F305 is set to 2 (quick deceleration), the inverter will increase the voltage to the motor (over-excitation control) to increase the amount of energy consumed by the motor when the voltage reaches the overvoltage protection level, and therefore the motor can be decelerated more quickly than normal deceleration.
 - ★ If F305 is set to 3 (dynamic quick deceleration), the inverter will increase the voltage to the motor (over-excitation control) to increase the amount of energy consumed by the motor as soon as the motor begins to slow down, and therefore the motor can be decelerated still more quickly than quick deceleration.
 - ★ The parameter F319 is used to adjust the maximum energy that the motor consumes during deceleration, and if the inverter is tripped during deceleration because of an overvoltage, specify a larger value.
 - ★ Parameter F626 serves also as a parameter for setting the regenerative braking level (see section 5.19).

6.15.3 Output voltage adjustment/Supply voltage correction

u L u : Base frequency voltage 1 (output voltage adjustment)
F307 : Base frequency voltage selection (supply voltage correction)

• Function
Base frequency voltage 1 (output voltage adjustment)
 This parameter is used to set the voltage for the base frequency 1 u L u . It can also be used to prevent the base frequency over u L u from being put out even if the voltage is higher than the voltage set is applied. (This parameter is operative when F307 is 2 or 3.)
Base frequency voltage selection (correction of supply voltage)
 The F307 parameter maintains a constant V/f ratio, even when the input voltage decreases. The torque during low-speed operation is prevented from decreasing.

- Supply voltage correction Maintains a constant V/f ratio, even when the input voltage fluctuates.
- Output voltage adjustment Limits the voltage at frequencies exceeding the base frequency. Note that no limit is imposed on the output voltage if the supply voltage is not compensated.

[Parameter setting]

Title	Function	Adjustment range	Default setting
$u \dot{L} u$	Base frequency voltage 1 (output voltage adjustment)	200V class: 50~330 V 400V class: 50~660 V	200V models: 200 400V models: 400
$F \dot{3} \dot{0} \dot{7}$	Base frequency voltage selection (correction of supply voltage)	0: Without voltage compensation (limitless output voltage) 1: With voltage compensation (limitless output voltage) 2: Without voltage compensation (limited output voltage) 3: With voltage compensation (limited output voltage)	0

- ★ If $F \dot{3} \dot{0} \dot{7}$ is set to 0 or 2, the output voltage will change in proportion to the input voltage.
- ★ Even if the base frequency voltage ($u \dot{L} u$) is set above the input voltage, the output voltage will not exceed the input voltage.
- ★ The rate of voltage to frequency can be adjusted according to the rated motor capacity. For example, setting $F \dot{3} \dot{0} \dot{7}$ to 3 prevents the output voltage from increasing, even if the input voltage changes when the operation frequency exceeds the base frequency.
- ★ When the V/f control mode selection parameter ($P \dot{L}$) is set to any number between 2, 3, 5 or 7, the supply voltage is corrected regardless of the setting of $F \dot{3} \dot{0} \dot{7}$.

[$F \dot{3} \dot{0} \dot{7}=0$: Supply voltage uncorrected, output voltage unlimited]

[$F \dot{3} \dot{0} \dot{7}=1$: Supply voltage corrected, output voltage unlimited]

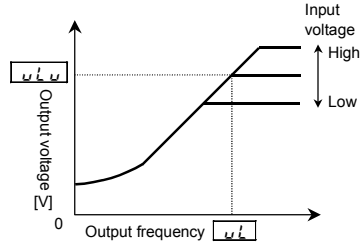
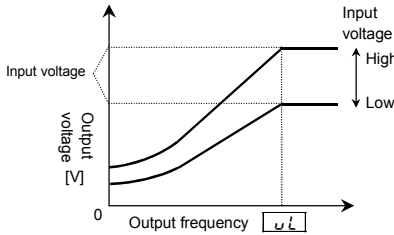

* The above applies when V/f control mode selection parameter $P \dot{L}$ is set to 0, 1 or 5.

* Note that a voltage higher than $u \dot{L} u$ is applied at output frequencies over the base frequency $u \dot{L}$, even if $u \dot{L} u$ is set below the input voltage.

$\frac{u \dot{L} u}{\text{Rated voltage}} > 1$ the output voltage can be prevented from exceeding the input voltage.

[$F \dot{3} \dot{0} \dot{7}=2$: Supply voltage uncorrected, output voltage limited]

[$F \dot{3} \dot{0} \dot{7}=3$: Supply voltage corrected, output voltage limited]

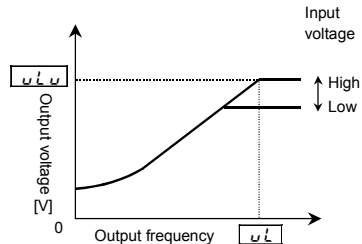
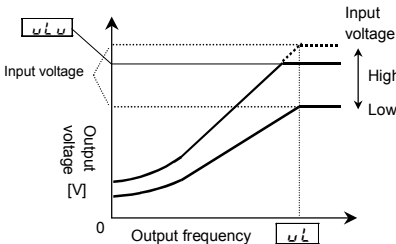

* The above applies when V/f control mode selection parameter $P \dot{L}$ is set to 0, 1 or 5.

$\frac{u \dot{L} u}{\text{Rated voltage}} > 1$ the output voltage can be prevented from exceeding the input voltage.

Note: Rated voltage is fixed for 200V class at 200V and 400V class at 400V.

6.15.4 Reverse run prohibition

F311 : Reverse run prohibition selection

Function
 This function prevents the motor from running in the forward or reverse direction when it receives the wrong operation signal.

[Parameter setting]

Title	Function	Adjustment range	Default setting
F311	Reverse-run prohibition selection	0:Permit all, 1:Prohibit reverse run 2:Prohibit forward run	0

Warning!!

- If an operation command is entered to rotate the motor in the direction prohibited for the preset speed operation with the mode or forced jog operation, this parameter will cancel the command regardless of operation mode.
- If the motor constant is not set properly while vector control mode or automatic torque boost mode is selected, the motor may turn in the reverse direction. The number of revolutions that correspond to the slip frequency, in these modes, therefore, the stop frequency (F243) should be set at the same level as the slip frequency. In sensor vector control mode (P_l = 7), depending on the setting of U_uS, the motor restarted may rotate in the direction opposite to the prohibited direction regardless of the setting of this parameter.

6.16 Drooping control

- F320** : Drooping gain
- F321** : Speed at drooping gain 0%
- F322** : Speed at drooping gain F320
- F323** : Drooping insensitive torque
- F324** : Drooping output filter

Function
 When multiple inverters and motors are used to operate a system, the load can distribute to them using this function. These parameters allow you to adjust the frequency range, and also insensitive torque and gain.

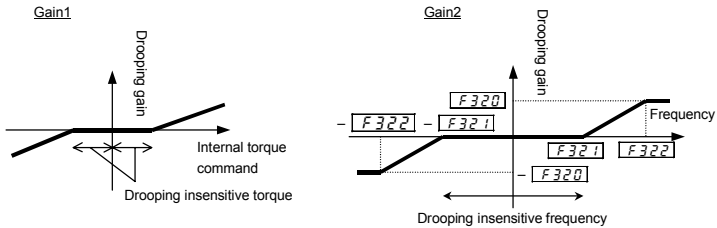

[Parameter setting]

Title	Function	Adjustment range	Default setting
F320	Drooping gain [Note]	0.0~100.0 %	0.0
F321	Speed at drooping gain 0%	0.0~320.0 Hz	0.0
F322	Speed at drooping gain F320	0.0~320.0 Hz	0.0
F323	Drooping insensitive torque	0~100 %	10
F324	Drooping output filter	0.1~200.0 rad/s	100.0

Note: Drooping gain can be changed within a range of 0.1 to 100.0% during operation. When changing the setting to 0.0 (no drooping) or 0.0, stop operation.

- Drooping control can be performed only when P_l is set to 3 or 7.
- When torque over the insensitive torque is applied, the frequency is decreased (during power running) or increased (during regenerative braking).
- The drooping function is operative at frequencies over the frequency set with F321.
- In the frequency range between the frequencies set with F321 and F322, the degree of drooping changes according to the magnitude of frequency.

- The error in drooping insensitive torque increases in the frequency range above the base frequency, and it is therefore recommended that these functions be used at frequencies below the base frequency.
- During drooping control, the output frequency is not restricted by the maximum frequency (F_H).

The change in frequency at the time of drooping can be calculated, as described below:

a) Gain by internal torque reference (Gain1)

If internal torque reference (%) ≥ 0

$$\text{Gain1} = (\text{internal torque reference} - \text{dead band } \boxed{F323}) / 100$$

Gain1 needs to be set at 0 or a positive number.

If internal torque reference (%) < 0

$$\text{Gain1} = (\text{internal torque reference} + \text{dead band } \boxed{F323}) / 100$$

Gain1 needs to be set at 0 or a negative number.

b) Gain by frequency after acceleration (Gain2)

If $\boxed{F321} < \boxed{F322}$

| Frequency after acceleration | \leq Frequency 1 set with $\boxed{F321}$

Gain2 = 0

| Frequency after acceleration | $>$ Frequency 2 set with $\boxed{F322}$

$$\text{Gain2} = \text{Drooping gain } \boxed{F320} / 100$$

If frequency 1 $\boxed{F321} <$ | Frequency after acceleration | \leq Frequency 2 $\boxed{F322}$

$$\text{Gain2} = \frac{\text{Drooping gain } \boxed{F320}}{100} \times \left\{ \frac{(| \text{Frequency after acceleration} | - \text{Frequency 1 } \boxed{F321})}{(\text{Frequency 2 } \boxed{F322} - \text{Frequency 1 } \boxed{F321})} \right\}$$

If $\boxed{F321} \geq \boxed{F322}$

| Frequency after acceleration | \leq Frequency 1 set with $\boxed{F321}$

Gain2 = 0

| Frequency after acceleration | $>$ Frequency 1 $\boxed{F321}$

$$\text{Gain2} = \text{Drooping gain } \boxed{F320} / 100$$

c) Drooping speed

$$\text{Drooping speed} = \text{base frequency } \boxed{vL}^{\text{Note}} \times \text{Gain1} \times \text{Gain2}$$

Note: If the base frequency exceeds 100 Hz, count it as 100 Hz.

6

6.17 Commercial power/inverter switching

- F354** : Commercial power/inverter switching output selection
- F355** : Commercial power/inverter switching frequency
- F356** : Inverter-side switching waiting time
- F357** : Commercial power-side switching waiting time
- F358** : Commercial power switching frequency holding time

• Function
 These parameters are used to specify whether to send a switching signal to an external sequencer (such as an MC) in the event that the inverter trips. The use of an input signal makes it possible to switch between inverter operation and commercial power operation without stopping the motor.

⇒ For details, see Instruction Manual (E6581364) specified in Section 6.36.

[Parameter setting]

Title	Function	Adjustment range	Default setting
F354	Commercial power/inverter switching output selection	0:Disabled 1:Automatic switching in the event of a trip 2:Commercial power switching frequency setting 3:Commercial power switching frequency setting + automatic switching in the event of a trip [Note1]	0
F355	Commercial power/inverter switching frequency	0~UL Hz	Inverter with a model number ending with -WN: 500 -WP: 500
F356	Inverter-side switching waiting time	0.10~10.00 sec.	According to model ⇒ Refer to page K-41.
F357	Commercial power-side switching waiting time	0.40~10.00 sec.	0.62
F358	Commercial power switching frequency holding time	0.10~10.00 sec.	2.00

Note: For trips whose causes are displayed with OCL, EF1, EF2 or E, switching is not done automatically.

[Timing chart (example)]

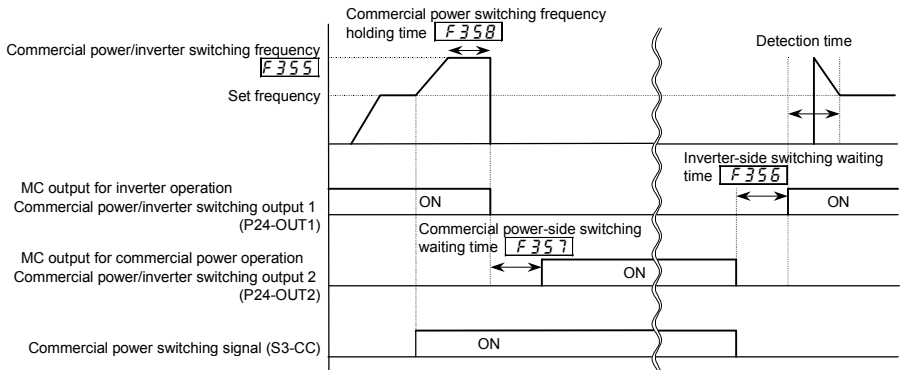

Commercial power switching signal S3-CC ON : Commercial power operation

Commercial power switching signal S3-CC OFF : Inverter operation

Note: If ST-CC is opened, switching cannot be operated normally.

Title	Function	Adjustment range	Example of setting
<i>F 3 5 4</i>	Commercial power/inverter switching output selection	0~3	2 or 3
<i>F 3 5 5</i>	Commercial power/inverter switching frequency	0~51 Hz	Power supply frequency etc.
<i>F 3 5 6</i>	Inverter-side switching waiting time	0.10~10.00 sec.	According to model ⇒ Refer to page K-41.
<i>F 3 5 7</i>	Commercial power-side switching waiting time	0.40~10.00 sec.	0.62
<i>F 3 5 8</i>	Commercial power switching frequency holding time	0.10~10.00 sec.	2.00
<i>F 1 1 7</i>	Input terminal function selection 7 (S3)	0~135	102 (Commercial power switching)
<i>F 1 3 0</i>	Output terminal function selection 1 (OUT1)	0~255	45 (Commercial power/inverter switching output 1)
<i>F 1 3 1</i>	Output terminal function selection 2 (OUT2)	0~255	48 (Commercial power/inverter switching output 2)

- Warning -

- When switching to commercial power, make sure that the direction in which the motor rotates when operated on commercial power agrees with the forward direction when operated via the inverter.
- Do not select any option (*F 3 1 1=2*) of *F 3 1 1* (reverse rotation prohibition selection) that prohibits forward rotation. Or it becomes impossible to switch to commercial power, because the motor cannot rotate in the forward direction.

6.18 PID control

F359	: PID control switching	F367	: Process upper limit
F360	: PID control feedback control signal selection	F368	: Process lower limit
F361	: Delay filter	F369	: PID control waiting time
F362	: Proportional (P) gain	F370	: PID output upper limit
F363	: Integral (I) gain	F371	: PID output lower limit
F364	: PID deviation upper limit	F372	: Process increasing rate (speed type PID control)
F365	: PID deviation lower limit	F373	: Process decreasing rate (speed type PID control)
F366	: Differential (D) gain	F374	: Frequency command agreement detection range

Function

Using feedback signals (4 to 20mA, 0 to 10V) from a detector, process control can be exercised, for example, to keep the airflow, amount of flow or pressure constant.

⇒ For details, see instruction Manual(E6581329)specified in Section.

[Parameter setting]

Title	Function	Adjustment range	Default setting
F359	PID control switching	0:No PID control 1:Process type PID control (temp./pressure, etc.) operation 2:Speed type PID control (potentiometer, etc.) operation	0
F360	PID control feedback control signal selection	0:Deviation input (no feedback input) 1:VI/II (voltage/current input) 2:RR/S4 (potentiometer/voltage input) 3:RX (voltage input) 4:Optional AI1 (differential current input) 5:Optional AI2 (voltage/current input) 6: PG feedback option	0
F361	Delay filter	0.0~25.0	0.1
F362	Proportional (P) gain	0.01~100.0	0.10
F363	Integral (I) gain	0.0~1~100.0	0.10
F364	PID deviation upper limit	LL~UL Hz	*1
F365	PID deviation lower limit	LL~UL Hz	*1
F366	Differential (D) gain	0.00~2.55	0.00
F367	Process upper limit	LL~UL Hz	*1
F368	Process lower limit	LL~UL Hz	LL
F369	PID control waiting time	0~2400 sec.	0
F370	PID output upper limit	LL~UL Hz	*1
F371	PID output lower limit	LL~UL Hz	LL
F372	Process increasing rate (speed type PID control)	0.1~600.0	10.0
F373	Process decreasing rate (speed type PID control)	0.1~600.0	10.0
F374	Frequency command agreement detection range	0.0~FH Hz	2.5

*1: Inverter with a model number ending with -WN: 60.0 -WP: 50.0

1) External connection

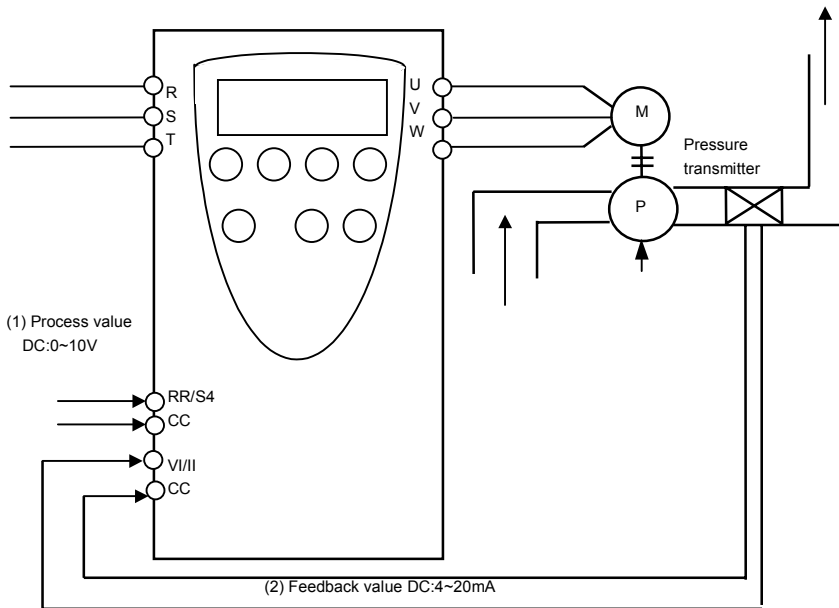

2) Types of PID control interface

Process value (frequency) and feedback value can be combined as follows for the PID control of the VF-PS1.

(1)Process value(frequency setting)	(2) Feedback value
Frequency setting mode selection <i>F 0 0 d / F 2 0 7</i>	PID control feedback control signal selection <i>F 3 6 0</i>
1:VI/II (voltage/current input)	0: Deviation input (no feedback input)
2:RR/S4 (potentiometer/voltage input)	1:VI/II (voltage/current input)
3:RX (voltage input)	2:RR/S4 (potentiometer/voltage input)
4:Operation panel input enabled (including LED/LCD option input)	3:RX (voltage input)
5:2-wire RS485 communication input	4:Optional AI1 (differential current input)
6:4-wire RS485 communication input	5:Optional AI2 (voltage/current input)
7:Communication option input	6: PG feedback option
8:Optional AI1 (differential current input)	
9:Optional AI2 (voltage/current input)	
10:UP/DOWN frequency	
11:Optional RP pulse input	
12:Optional high-speed pulse input	

Note 1: About the setting of *F 0 0 d* and *F 2 0 7*: Do not select the same terminal that is used feedback terminal.

Note 2: The voltage/current changeover of the analog input VI/II and the option AI1 can be set by the parameter *F 1 0 8* or *F 1 0 9*.

F 1 0 8, F 1 0 9 0:Voltage input (DC:0~10V)
1:current input (DC:4~20mA)

Note 3: The reaching signal of the feedback value and the process value can be output.

The desired feedback input should be assigned to the unoccupied output terminal.

The detection width for reaching can be set by the parameter *F 3 7 4*.

If the feedback input is RR/S4 terminal: Function number 144,145

If the feedback input is VI/II terminal : Function number 146,147

If the feedback input is RX terminal : Function number 148,149

3) Setting the PID control

In case of controlling the airflow, water flow and pressure, please set the parameter *F 3 5 9* to " 1 "(Process type PID control operation)

- (1)Please set the parameter *R C C* (Acceleration time), *d E C* (deceleration time) to the suitable time for the system.
- (2)Please set the following parameters to place limits to the setting value and the control value.

Placing a limit to the process value : The parameter *F 3 5 7*(Process upper limit), *F 3 5 8* (Process lower limit)
 Placing a limit to the PID deviation : The parameter *F 3 5 4*(PID deviation upper limit), *F 3 5 5* (PID deviation lower limit)
 Placing a limit to the PID output : The parameter *F 3 7 0*(PID output upper limit), *F 3 7 1* (PID output lower limit)
 Placing a limit to the output frequency : The parameter *U L* (Upper limit frequency), *L L* (Lower limit frequency)

4) Adjust PID control gain

Adjust PID control gains according to the process value, the feedback input signal and the item to be controlled. Here are the parameters used to adjust PID control gains.

Title	Function	Adjustment range	Default setting
<i>F 3 6 2</i>	Proportional (P) gain	0.0 1~100.0	0.10
<i>F 3 6 3</i>	Integral (I) gain	0.0 1~100.0	0.10
<i>F 3 6 6</i>	Differential (D) gain	0.00~2.55	0.00

F 3 6 2 Proportional (P) gain

The proportional (P) gain set with f362 is the proportional (P) gain obtained by PID control. A proportional (P) gain, a factor by which the deviation (difference between the process value and the feedback value) is multiplied, is used to perform control in such a way as to make a correction in proportion to the deviation. Although setting this gain high is effective in increasing the response speed, setting it excessively high may cause an unstable operation, such as vibration.

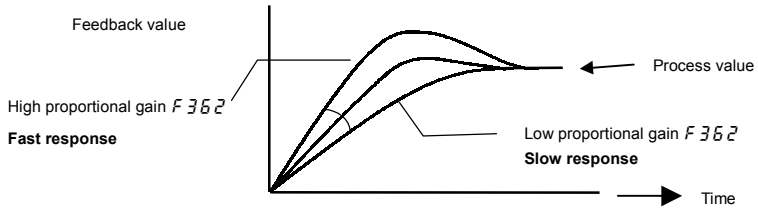

F 3 6 3 Integral (I) gain

The integral (I) gain set with f363 is the integral (I) gain obtained by PID control. The integral gain reduces the deviation remaining after proportional control to zero (offsetting of residual deviation). Although setting this gain high is effective in reducing the residual deviation, setting it excessively high may cause an unstable operation, such as vibration.

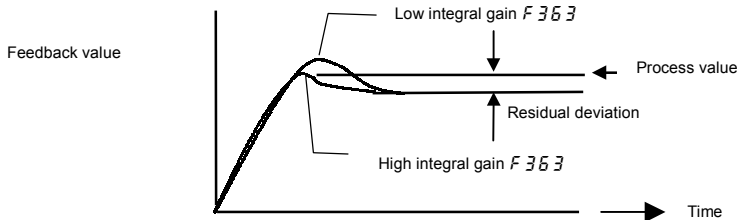

F 366: Differential (D) gain

The differential (D) gain set with f366 is the differential (D) gain obtained by PID control.

The differential gain increases the speed of response to rapid changes in deviation. If this gain is set excessively high, a phenomenon in which the output frequency greatly fluctuates may occur.

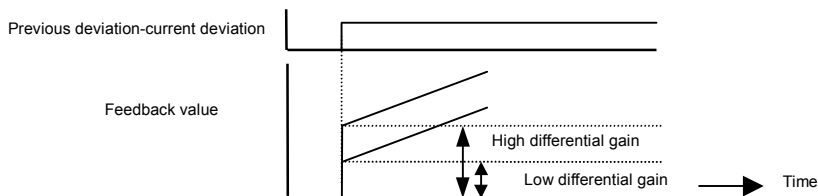

If one of input terminals is assigned input terminal function 52/53 (PID differentiation/integration reset), differential and integral values are always 0 (zero) during the input terminal on.

5) Adjusting the analog command voltage and current

For items which can be adjusted by reference and feedback input, such as voltage/current input (VI/II input), voltage input (RR/S4 input) and voltage input (RX input), adjust scaling factor of the voltage/current if necessary.

When feedback signals are very low, the gain can be increased by this adjustment.

When VI/II used as a voltage input terminal (Default setting)

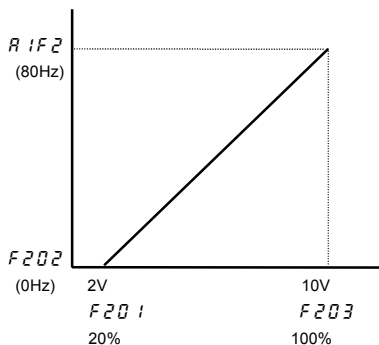

When VI/II used as a current input terminal (F108 needs to be set to 1)

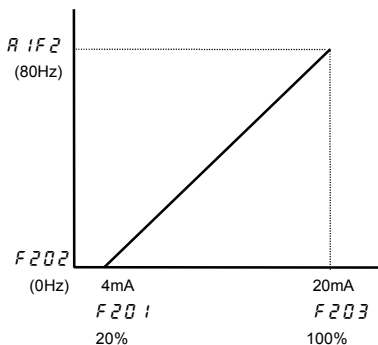

When RR/S4 used as a voltage input terminal (Default setting)

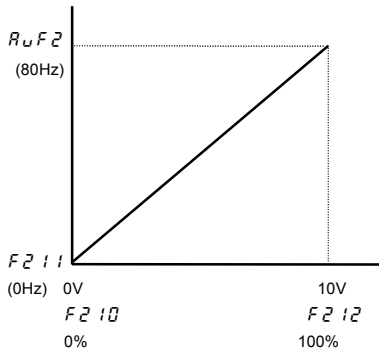

When RX used as a voltage input terminal (Default setting)

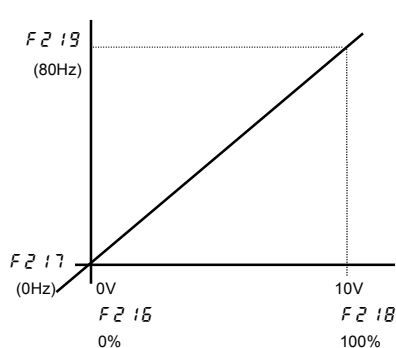

6

The characteristic of the feedback value can also be reversed by means of a signal from an external device.

Example: To use the S3 terminal as a PID normal/reverse characteristic switching signal input terminal

Title	Function	Adjustment range	Default setting
F117	Input terminal function selection7(S3)	0~135	54 (positive logic) 55 (negative logic)

6) Setting the time elapsed before PID control starts



You can specify a waiting time for PID control to prevent the inverter from starting PID control before the control system becomes stable, for example, after start-up.

The inverter ignores feedback input signals, carries out operation at the frequency determined by the value of processing for the time specified by F369 and enters the PID control mode after a lapse of the specified time.

6.19 Setting motor constants

F400	: Auto-tuning 1	F407	: Motor rated rotational speed (motor nameplate)
F401	: Slip frequency gain	F410	: Motor constant 1 (torque boost)
F402	: Cooled	F411	: Motor constant 2 (no-load current)
F405	: Motor rated capacity (motor nameplate)	F412	: Motor constant 3 (leak inductance)
F406	: Motor rated current (motor nameplate)	F413	: Motor constant 4 (rated slip)

When selecting automatic torque boost and vector control (i.e., when setting the parameter P_L to 2, 3, 4 or 7. By default, P_L is set to 0 (v/f constant control)), be sure to set every parameter concerned in accordance with the flowchart on the next page.

 Warning	
 Mandatory	Be sure to set every parameter concerned in accordance with the flowchart on the next page. Failure to do this may cause the inverter not to control the motor properly, and therefore cause the motor not to deliver the desired performance.

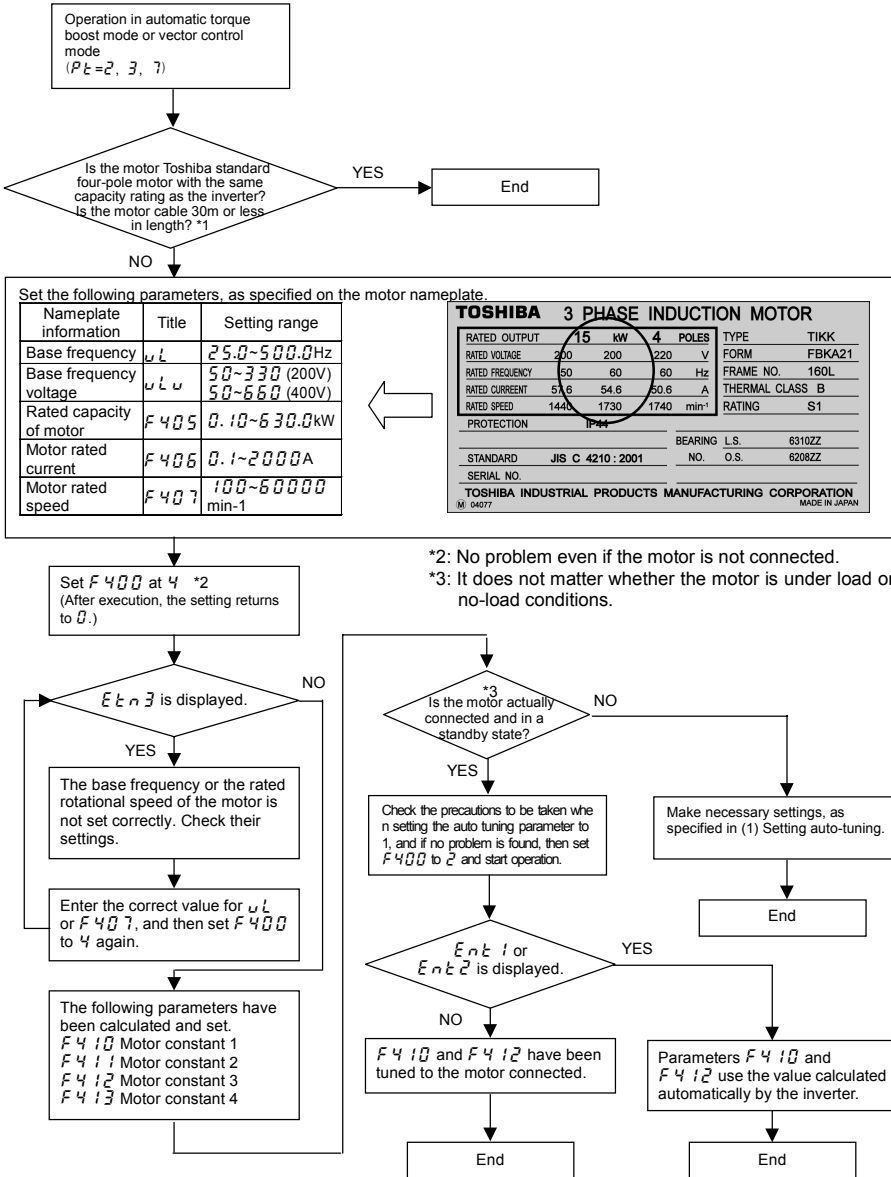

*1:

Motor used			Tuning required or not (Yes in flowchart: Tuning required, No: Tuning not required)
Type	No. of motor poles	Capacity	
Toshiba standard motor	4P	Same as the inverter capacity	* Not required (tuned to factory defaults)
		Different from the inverter capacity	Required
	Other than 4P	Same as the inverter capacity	
	Different from the inverter capacity		
Others			

* When using a long cable (guide: 30m or over), be sure to make auto-tuning 1 (F400=2).

(1) Setting auto-tuning

This auto tuning function allows you to set the motor constant easily, which needs to be set when operating in auto torque boost mode or vector control mode ($P\tau = 2, 3$ or 7).

There are two parameters ($F400$ and $F402$ described below) for auto tuning. For the steps to be followed when setting these parameters, see the flowchart on the previous page. This section provides an explanation of $F400$ and $F402$.

[Parameter setting]

Title	Function	Adjustment range	Default setting
$F400$	Auto-tuning 1	0 :No auto-tuning 1 :Initialize motor constant (0 after execution) 2 :Continue operation continued after auto-tuning (0 after execution) 3 :Auto-tuning by input terminal signal 4 :Motor constant auto calculation (0 after execution)	0

$F400=1$: Resets $F410$ (motor constant 1), $F411$ (motor constant 2), $F412$ (motor constant 3) and $F413$ (motor constant 4) to their factory default settings (constant of a Toshiba standard four-pole motor with the same capacity as the inverter).

$F400=2$: Makes the inverter tune the motor constant, considering how the motor is connected, when it is started for the first time after this setting is made. Connect the motor to the inverter in advance when selecting this setting.

$F400=3$: Makes the inverter only tune the motor constant, unlike $F400=2$. Connect the motor to the inverter in advance when selecting this setting.
 (Use this setting if the machine cannot be started as-is after tuning for some reason on the part of the machine.)

$F400=4$: If you select this setting after entering the information indicated on the motor nameplate (ωL (base frequency), $\omega L V$ (base frequency voltage), $F406$ (rated current of motor), $F407$ (rated speed of rotation of motor)), the inverter will calculate the motor constant and set the parameters $F410$ through $F413$ automatically.

There is no need to connect the motor when making this setting.

[Parameter setting]

Title	Function	Adjustment range	Default setting
$F402$	Cooled	0 :Disabled 1 :Self-cooled motor 2 :Forced-air-cooled motor	0

Cooled refers to the function of adjusting the motor constant automatically, while estimating the increase in the motor temperature.

If your inverter is equipped with a self-cooling fan (fan connected directly to the motor shaft), set $F402$ to 1 . When using a motor with a cooling fan (forced air-cooling type), set $F402$ to 2 .

- Perform Cooled along with auto-tuning 1.
- Perform auto-tuning when the motor is cold (temperature equal to the ambient temperature).

★Precautions on auto-tuning 1

- (1) The inverter is tuned automatically (auto-tuning 1 $F400=2$) when the inverter is started for the first time after setup. During auto-tuning 1, which takes several seconds, the motor is energized, although it is standing still. Noise may be produced by the motor during auto-tuning 1, which, however, does not indicate that something is wrong with the inverter or the motor.
- (2) Conduct auto-tuning 1 ($F400=2$) only after the motor has been connected and operation completely stopped.
 If auto-tuning is conducted immediately after operation stops, the presence of a residual voltage may result in abnormal tuning.
- (3) Usually, auto-tuning terminates in some seconds. If an error occurs, however, the inverter trips (display $E\tau n$) and no motor constant is set. For these motors, perform manual tuning using (2) described below.
- (4) It may not be possible to tune automatically special motors such as high-speed motor or high-slip motor. For these motors, perform manual tuning using (2) described below.
- (5) Provide cranes and hoists with sufficient circuit protection such as mechanical braking. Without sufficient circuit protection, the result of insufficient motor torque during tuning could create the risk of the machine stalling/failing.
- (6) If auto-tuning is impossible or an auto-tuning error ($E\tau n$) is displayed, perform manual tuning with (2) described below.

★Precautions on vector control \Rightarrow Refer to Section 5.6,10).

■ Examples of setting the motor constants

a) Combination with a Toshiba standard motor (4P motor with the same capacity as the inverter)

Inverter : VFPS1-2037PL

Motor : 3.7kW-4P-60Hz

- 1) Set the V/f control mode selection P_{L} at 3 (Sensorless vector control).
- 2) Set the auto-tuning 1 (F_{400}) at 2 . (When the cable length is 30m or over.)

b) Combination with a standard motor other than the above Toshiba motor

Inverter : VFPS1-2037PL

Motor : 2.2kW-2P-50Hz

- 1) Set the V/f control mode selection P_{L} at 3 (Sensorless vector control).
- 2) Set ω_{L} , ω_{L} , F_{405} , F_{406} and F_{407} , as specified on the motor nameplate.
- 3) Set the auto-tuning 1 (F_{400}) at 4 .
- 4) Set the auto-tuning 1 (F_{400}) at 2 .

(2) Setting sensorless vector control and manual independently

Setting motor constants

Perform all operations in the flowchart on the previous page. If the motor specifications are unknown, enter only the motor capacity (F_{405}) and set parameter F_{400} to 4 . After that, run the motor and set other parameters with the following explanation about parameter adjustments as a guide.

This section describes how to set motor constants. Select the items to be improved and change the related motor constants.

(1) Slip frequency gain F_{401}

This parameter is to adjust the slippage of the motor.

Setting this parameter at a larger number can reduce the slippage of the motor. However, setting it at an excessively large number may result in hunting, etc., and thus cause an unstable operation.

(2) Motor constant 1 F_{410} (Torque boost) (Motor test reports may be useful.)

This parameter is to adjust the primary resistance of the motor. Setting this parameter at a larger value can prevent the drop of the motor torque in low speed ranges due to a voltage drop. However, setting it at an excessively large number may result in large current in low speed range and appearance of an overload trip, etc.

(3) Motor constant 2 F_{411} (No-load current) (Motor test reports may be useful.)

This parameter is to adjust the exciting inductance of the motor. The larger the set value, the more exciting current can be increased. Note that specifying a too large value for the motor constant may cause hunting.

(4) Motor constant 3 F_{412} (Leak inductance) (Motor test reports may be useful.)

This parameter is to adjust the leakage inductance of the motor. The larger the set value, the larger torque the motor can produce in high-speed ranges.

(5) Motor constant 4 F_{413} (Rated slip)

This parameter is to adjust the secondary resistance of the motor. The amount of compensation for slip increases with increase in this value.

(6) F_{406} (Speed loop proportional gain)

This parameter is to adjust the gain responsive to speed. Specifying a large gain increases the speed of response, but specifying an excessively large gain may result in the occurrence of hunting. If operation is unstable and hunting occurs, operation can be stabilized in most cases by reducing the gain.

(7) F_{407} (Moment of inertia of load)

This parameter is used to adjust the excess response speed. Specifying a large value reduces the amount of overshoot at the completion of acceleration. So, specify a value appropriate to the actual moment of inertia of the load.

6.20 Increasing the motor output torque further in low speed range

F415 : Exciting strengthening coefficient

F416 : Stall prevention factor

The output torque of the motor can adjusted using the parameters described in 6.19 in most cases, but if a finer adjustment is required, use these parameters.

[Parameter setting]

Title	Function	Adjustment range	Default setting
F415	Exciting strengthening coefficient	100~130 %	100
F416	Stall prevention factor	10~250	100

★If the torque needs to be increased in low speed range (10Hz or less as a guide)

Perform auto-tuning according to the instructions in 6.19, and if the torque needs to be increased further in low speed range, first increase the slip frequency gain (F401) to a degree (80% or so as a guide) that hunting of the motor does not occur. Then, increase motor constant 1 (F410) by 1.1 times the current value as a guide. If the torque needs to be increased even further, increase the exciting current factor (F415) to a maximum of 130%.

F415 is a parameter that increases the magnetic flux of the motor at low speeds, so specifying a higher value for F415 increases the no-load current. If the no-load current exceeds the rated current, do not adjust this parameter.

★If the motor stalls when operated at frequencies above the base frequency

Adjust F416 (stall prevention factor).

If a heavy load is applied momentarily (transiently), the motor may stall before the load current reaches the stall prevention level (F501). In such a case, a motor stall may be avoided by reducing the value of F416 gradually.

6.21 Torque limit

F440 : Power running torque limit selection

F441 : Power running torque limit level

F442 : Regenerative braking torque limit selection

F443 : Regenerative braking torque limit level

F454 : Constant output zone torque limit selection

• Function

This function is to decrease or increase the output frequency according to the loading condition when the motor torque reaches the limit level. Setting a torque limit parameter at 250% means "Invalid."

With this function, you can also select from between limiting the constant output or limiting the constant torque in the constant output zone.

■ Setting methods

(1) When setting limits to torque, use internal parameters (Torque limits can also be set with an external control device.)

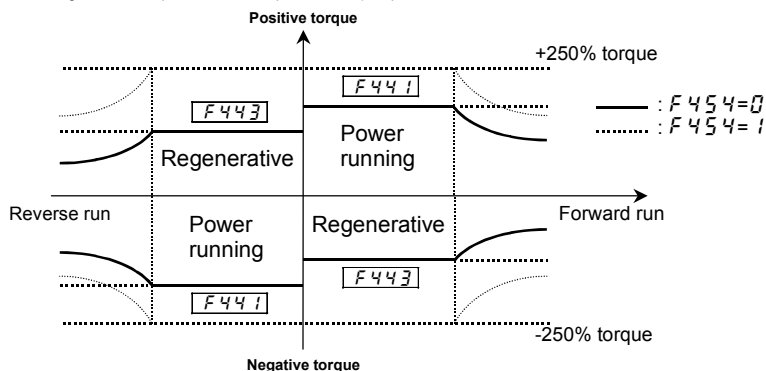

With the parameter **F454**, you can select the item that is limited in the constant output zone (somewhat weak magnetic field) from between constant output (**F454=0**: default setting) and constant torque (**F454=1**). When you select the constant torque limit option, you should preferably select the output voltage limit option (**F307=3**) with the parameter **F307** (base frequency voltage selection).

Torque limits can be set with the parameters **F441** and **F443**.

[Setting of power running torque]

F440 (Power running torque limit selection) : Set at 4 (**F441**)

F441 (Power running torque limit) : Set a desirable torque limit level.

[Setting of regenerative torque]

F442 (Regenerative braking torque limit selection) : Set at 4 (**F443**)

F443 (Regenerative braking torque limit) : Set a desirable torque limit level.

[Parameter setting]

Title	Function	Adjustment range	Default setting
F440	Power running torque limit selection	1:V/I (voltage/current input) 2:RR/S4 (potentiometer/voltage input) 3:RX (voltage input) 4: F441	4
F441	Power running torque limit level	0.0~249.9% 250.0%:Disabled	250.0%
F442	Regenerative braking torque limit selection	1:V/I (voltage/current input) 2:RR/S4 (potentiometer/voltage input) 3:RX (voltage input) 4: F443	4
F443	Regenerative braking torque limit level	0.0~249.9% 250.0%:Disabled	250.0%
F454	Constant output zone torque limit selection	0 : Constant output limit 1 : Constant torque limit	0

Note:If the value set with **F601** (stall prevention level) is smaller than the torque limit, then the value set with **F601** acts as the torque limit.

(2) When setting limits to torque, using external signals

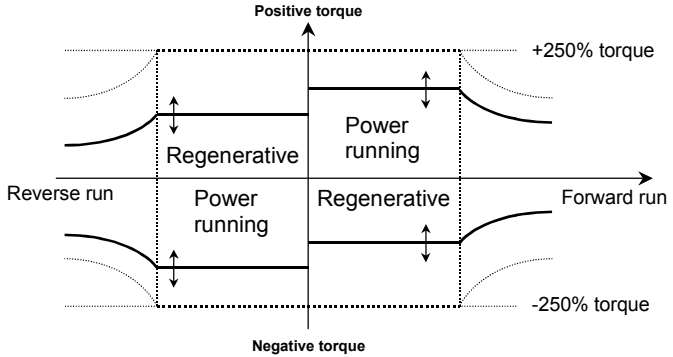

The torque limits can be changed arbitrarily by means of external signals.

[Selection of external signals]

F 4 4 0 , F 4 4 2

- Voltage signals
 - RR/S4 -CCA - 0~10V 2
 - RX-CCA - 0~±10V 3
 - VI/II-CCA - 0~10V 1
- Current signals
 - VI/II-CCA - 4(0)~20mA 1

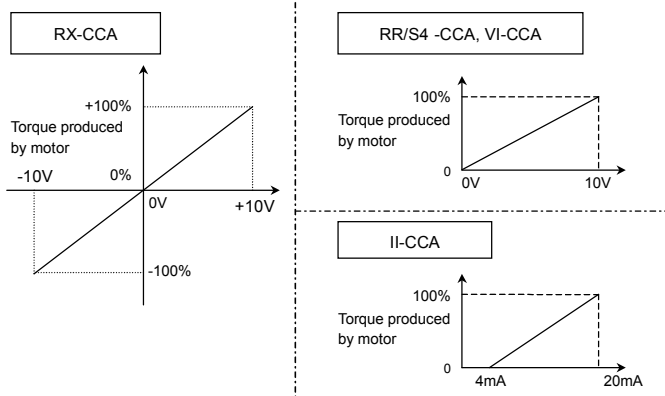

[Parameter setting]

Title	Function	Adjustment range	Default setting
F 4 4 0	Power running torque limit selection	1:VI/II (voltage/current input) 2:RR/S4 (potentiometer/voltage input) 3:RX (voltage input) 4:F 4 4 1	4
F 4 4 2	Regenerative braking torque limit selection	1:VI/II (voltage/current input) 2:RR/S4 (potentiometer/voltage input) 3:RX (voltage input) 4:F 4 4 3	4

6.22 Speed control gain

F460 - **F462** : Speed control gain

⇒ For details, refer to Instruction Manual (E6581333) specified in Section 6.36.

6.23 Fine adjustment of frequency setting signal

F470 : VI/II input bias

F471 : VI/II input gain

F472 : RR/S4 input bias

F473 : RR/S4 input gain

F474 : RX input bias

F475 : RX input gain

F476 : Optional AI1 input bias

F477 : Optional AI1 input gain

F478 : Optional AI2 input bias

F479 : Optional AI2 input gain

□ **Function**

These parameters are used to fine adjust the relation between the frequency setting signal input through the analog input terminal and the output frequency.

Use these parameters to make fine adjustments after making rough adjustments using the parameters

F201~F231. □

The figure below shows the characteristic of the frequency setting signal input through the analog input terminal and that of the output frequency.

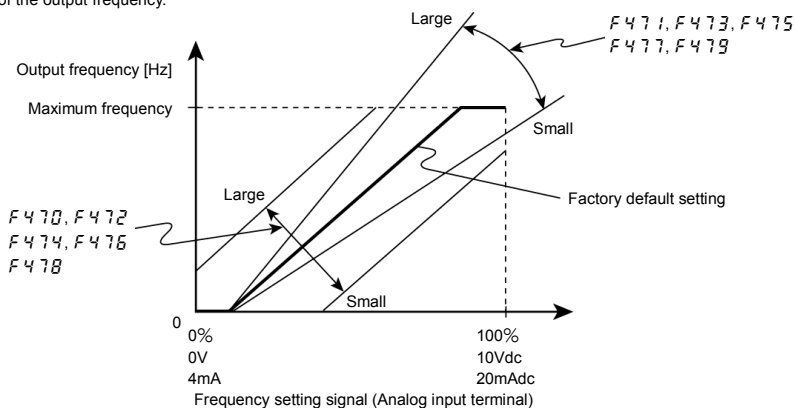

★Bias adjustment of analog input terminals (F470, F472, F474, F476, F478)

To give leeway, the inverter is factory-adjusted by default so that it will not produce an output until a certain amount of voltage is applied to the analog input terminals.

To reduce leeway, decrease the bias of the analog terminal in use.

Note that specifying a too large value may cause an output frequency to be output, even though the operation frequency is 0 (zero) Hz.

★Gain adjustment of analog input terminals (F471, F473, F475, F477, F479)

The inverter is factory-adjusted by default so that the operation frequency can reach the maximum frequency, even though the voltage and current to the analog input terminals are below the maximum levels.

To make an adjustment so that the frequency reaches its peak value at the maximum voltage and current, decrease the gain of the analog terminal in use.

Note that specifying a too small value may cause the operation frequency not to reach the maximum frequency, even though the maximum voltage and current are applied.

6.24 Operating a synchronous motor

F498, F499 : PM motor constant 1

F640, F641 : Step-out detection current level/ detection time

This parameter is used only when the inverter is used with a synchronous motor. If you intend to use your inverter with a synchronous motor, contact us at the your supplier.

6.25 Acceleration/deceleration 2

6.25.1 Setting acceleration/deceleration patterns and switching

acceleration/deceleration patterns 1 and 2

F500 : Acceleration time 2

F501 : Deceleration time 2

F502 : Acceleration/deceleration 1 pattern

F503 : Acceleration/deceleration 2 pattern

F504 : Panel acceleration/deceleration selection

F505 : Acceleration/deceleration switching frequency

• Function

Four acceleration times and two deceleration times can be specified individually. The selection/switching mode can be selected from the following 3 options:

- 1) Selection by means of parameters
- 2) Switching by means of frequencies
- 3) Switching by means of terminals

[Parameter setting]

Title	Function	Adjustment range	Default setting
F500	Acceleration time 2	0.1[Note]~6000 sec.	According to model
F501	Deceleration time 2	0.1[Note]~6000 sec.	According to model
F504	Panel acceleration/deceleration selection	1: Acceleration/deceleration 1 2: Acceleration/deceleration 2	1

Note: The minimum setting of acceleration and deceleration times have been set respectively at 0.1 sec. by default, but they can be changed within a range of 0.01 sec. (setting range: 0.01~600.0 sec.) by changing the setting of the parameter ϵYP (default setting).

⇒ For details, refer to Section 5.20.

1) Selection using parameters

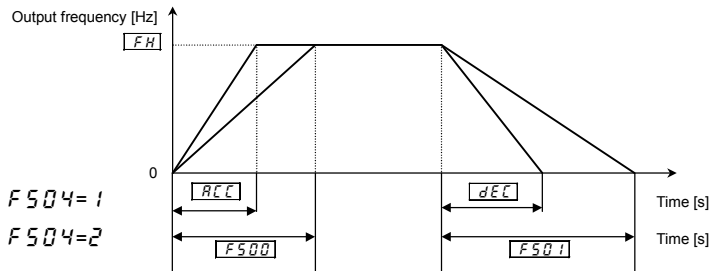

Acceleration/deceleration time 1 is initially set as the default. Acceleration/deceleration time 2 can be selected by changing the setting of the F504.

Enabled if $\epsilon RD = 1$ (operation panel input enabled).

2) Switching by frequencies - Automatically switching acc/dec times at certain frequencies

Title	Function	Adjustment range	Default setting
F505	Acceleration/deceleration switching frequency	0.0~FH Hz	0.0

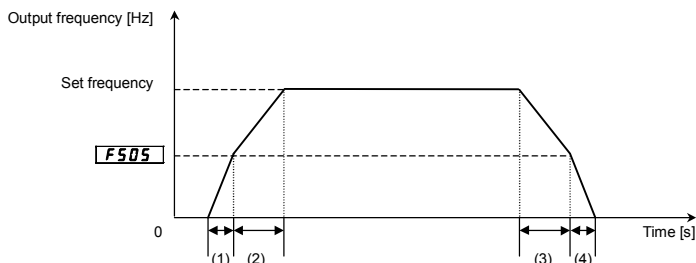

- (1) Acceleration at the gradient corresponding to acceleration time $R L C$
 (2) Acceleration at the gradient corresponding to acceleration time $F 5 0 0$
 (3) Deceleration at the gradient corresponding to deceleration time $F 5 0 1$
 (4) Deceleration at the gradient corresponding to deceleration time $d E L$

3) Switching using external terminals - Switching the acceleration/deceleration time via external terminals

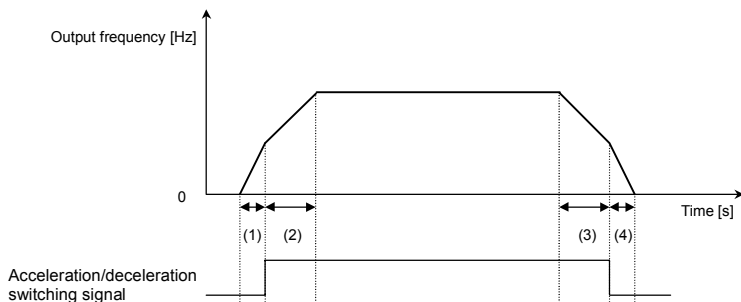

- (1) Acceleration at the gradient corresponding to acceleration time $R L C$
 (2) Acceleration at the gradient corresponding to acceleration time $F 5 0 0$
 (3) Deceleration at the gradient corresponding to deceleration time $F 5 0 1$
 (4) Deceleration at the gradient corresponding to deceleration time $d E L$

■ Setting parameters

a) Operating method: Terminal input

Set the command mode selection $C 1 0 d$ to 0 .

b) Use the S2 terminals for switching. (Instead, other terminals may be used.)

Title	Function	Adjustment range	Example of setting
F116	Input terminal function selection 6 (S2)	0~135	24 (Acceleration/deceleration switching signal 1)

■ Acceleration/deceleration pattern

Acceleration/deceleration patterns can be selected individually, using the acceleration/deceleration 1 and 2 parameters.

- 1) Straight acceleration/deceleration
- 2) S-pattern acceleration/deceleration 1
- 3) S-pattern acceleration/deceleration 2

Title	Function	Adjustment range	Default setting
F502	Acceleration/deceleration 1 pattern	0: Straight, 1: S-pattern 1, 2: S-pattern 2	0
F503	Acceleration/deceleration 2 pattern	0: Straight, 1: S-pattern 1, 2: S-pattern 2	0

- 1) Straight acceleration/deceleration
A general acceleration/deceleration pattern.
This pattern can usually be used.

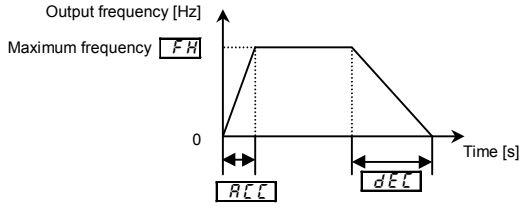

- 2) S-pattern acceleration/deceleration 1
Select this pattern to accelerate/decelerate the motor rapidly to a high-speed region with an output frequency of 60Hz or more or to minimize the shocks applied during acceleration/deceleration. This pattern is suitable for conveyer machines.

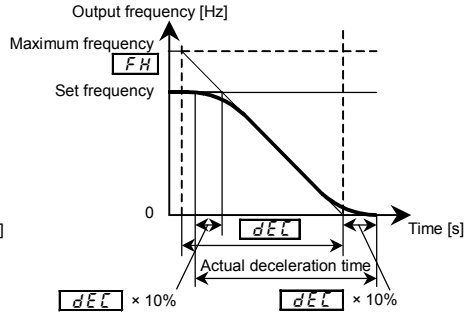
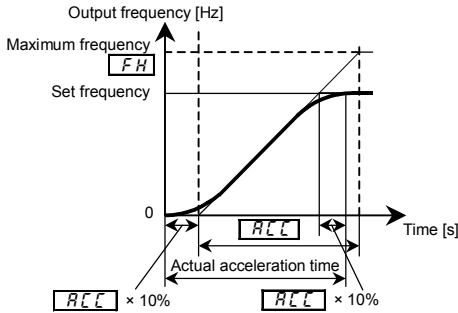

6

- 3) S-pattern acceleration/deceleration 2
Select this pattern to obtain slow acceleration in a demagnetizing region with a small motor acceleration torque. This pattern is suitable for high-speed spindle operation.

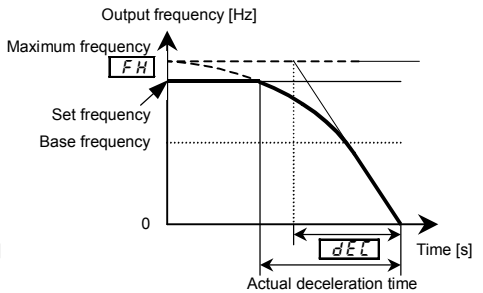
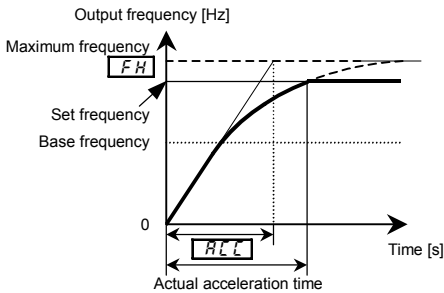

6.26 Protection functions

6.26.1 Setting of stall prevention level

F601 : Stall prevention level

Warning	
 Prohibited	<ul style="list-style-type: none"> Do not set the stall prevention level (F601) extremely low. If the stall prevention level parameter (F601) is set at or below the no-load current of the motor, the stall preventive function will be always active and increase the frequency when it judges that regenerative braking is taking place. Do not set the stall prevention level parameter (F601) below 30% under normal use conditions.

Function
 This parameter reduces the output frequency by activating a current stall prevention function against a current exceeding the F601-specified level.

[Parameter setting]

Title	Function	Adjustment range	Default setting
F601	Stall prevention level	0~164%, 165:Deactivated	120

[Display during the alarm 0C]

During an 0C alarm status, (that is, when there is a current flow in excess of the stall prevention level), the output frequency changes. At the same time, to the left of this value, "C" is displayed flashing on and off.

Example of display C 50

6.26.2 Inverter trip record retention

F602 : Inverter trip record retention selection

Function
 If the inverter trips, this parameter will retain the corresponding trip information. Trip information that has thus been stored into memory can be displayed, even after power has been reset.

[Parameter setting]

Title	Function	Adjustment range	Default setting
F602	Inverter trip record retention selection	0:Clear when power is turned off. 1:Retain even after power is turned off.	0

★Up to four sets of latest trip records displayed in status monitor mode can be stored into memory.

★Data (current, voltage, etc.) displayed in status monitor mode when the inverter is tripped is cleared when power is turned off.

■ Flow of operation when F602=1

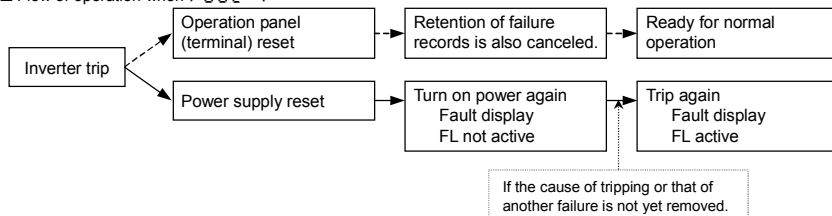

6.26.3 Emergency stop

F603 : Emergency stop

F604 : Emergency DC braking control time

• Function

Emergency stop mode can be selected. At emergency stop, a trip message ("E") is displayed. FL relay can be deactivated using the output function selection.

1) Emergency stop by terminal operation

Emergency stop can be performed with the a or b-contact. Assign the emergency stop function to a terminal as described below, and select a stop mode.



2) Emergency stop

F603=1: The motor is brought to a stop within the time specified with **dEE**

F603=2: DC braking is performed at the current specified with **F251** (DC braking current) for the time specified with **F604** (emergency DC braking control time).

Use this setting to bring the motor to a stop within time different from the normal deceleration time specified with **dEE**.

3) Selecting the operation of the FL relay

Using the output terminal selection parameter, you can specify whether or not to operate the FL relay.

F132 (output terminal selection 3) = **10** (default): Operates the FL relay in the event of an emergency stop.

F132 (output terminal selection 3) = **134**: Does not operate the FL relay in the event of an emergency stop.

[Parameter setting]

Title	Function	Adjustment range	Default setting
F603	Emergency stop	0 :Coast stop 1 :Deceleration stop 2 :Emergency DC braking	0
F604	Emergency DC braking control time	0.0~20.0 sec.	1.0
F251	DC braking current	0~100 %	50

(Example of terminal assignment): Assigning the emergency stop function to the S3 terminal.

Title	Function	Adjustment range	Example of setting
F117	Input terminal function selection 7(S3)	0~135	20 (Emergency stop)

Note 1: Emergency stopping via the specified terminal is possible, even during operation panel operation.

Note 2: If **F603=2** (Emergency DC braking) and DC braking is not required for normal stopping, set the DC braking time **F252** to **0.0** [s].

4) Emergency stopping from the operation panel is possible

Pressing the STOP key on the operation panel twice enables emergency stop.

(1) Press the STOP key — "E0FF" will blink.

(2) Press the STOP key again — If **F603** (Emergency stop) = **0~2**, the motor makes an emergency stop (or trips) according to the setting.

If "E" is displayed an error detection signal (FL) is issued (FL is activated).

6.26.4 Output phase failure detection

F605 : Output phase failure detection mode selection

• **Function**

This parameter detects inverter output phase failure. If the inverter detects an open phase failure, the tripping function and the FL relay will be activated. At the same time, the trip information *EPH0* will also be displayed.

Set *F605=5* to open the motor-inverter connection by switching commercial power operation to inverter operation.

Detection errors may occur for special motors such as high-speed motors.

F605=0: No tripping

F605=1: With the power on, the phase failure detection is enabled only at the start of the first operation. The inverter will trip if the inverter detects an open phase failure.

F605=2: The inverter checks for output phase failures each time it starts operation. The inverter will trip if the inverter detects an open phase failure.

F605=3: The inverter checks for output phase failures during operation. The inverter will trip if the inverter detects an open phase failure.

F605=4: The inverter checks for output phase failures at the start of and during operation. The inverter will trip if the inverter detects an open phase failure.

F605=5: If the inverter detects an open phase failure in every phase, it does not trip but restarts operation when every phase is reconnected.

The inverter does not check for output phase failures when restarting after a momentary power failure.

Note: A check for output phase failures is made during auto-tuning 1 (*F400=2, 3*), regardless of the setting of this parameter *F605*.

[Parameter setting]

Title	Function	Adjustment range	Default setting
<i>F605</i>	Output phase failure detection mode selection	<i>0</i> : Deselect <i>1</i> : At starting (only one time after power is turned on) <i>2</i> : At starting (each time power is turned on) <i>3</i> : During operation <i>4</i> : At starting + during operation <i>5</i> : Output cut-off detection enabled	<i>0</i>

6.26.5 OL reduction starting frequency

F606 : OL reduction starting frequency

⇒ For more details, refer to Section 5.14.

6.26.6 Input phase failure detections

F608 : Input phase failure detection mode selection

• **Function**

This parameter detects inverter input phase failure. At the occurrence of a phase failure, the *EPH1* protection message is displayed.

F608=0: No tripping (Failure signal FL deactivated).

F608=1: This parameter detects inverter input phase failure. If the inverter detects an open phase failure, it trips.

[Parameter setting]

Title	Function	Adjustment range	Default setting
<i>F608</i>	Input phase failure detection mode selection	<i>0</i> : Disabled, <i>1</i> : Enabled	<i>1</i>

Note 1: Setting *F608* to *0* (input phase failure detection: disabled) may result in a breakage of the capacitor in the inverter main circuit if operation is continued under a heavy load in spite of the occurrence of an input phase failure.

Note 2: When using a single-phase direct current to operate the inverter, disable this function (*F608=0*)

6.26.7 Control mode for low current

- F609** : Low current detection hysteresis width
- F610** : Low current trip selection
- F611** : Low current detection current
- F612** : Low current detection time

• Function
 If the current is lower than **F611** level and passes for a time longer than **F612**, the inverter trips.
 Trip information is displayed as "UL."

- F610=0**: No tripping (Failure signal FL deactivated).
 A low current alarm can be put out by setting the output terminal function selection parameter.
- F610=1**: The inverter will trip (the failure signal FL will be activated) if a current below the current set with **F611** flows for the period of time specified with **F612**.

Title	Function	Adjustment range	Default setting
F609	Low current detection hysteresis width	1~20 %	10
F610	Low current trip selection	0: No trip 1: Trip	0
F611	Low current detection current	0~100 %	0
F612	Low current detection time	0~255 sec.	0

<Example of operation>
Output terminal function: 26 (UC) Low current detection

F610=0 (No trip)

Ex.) When outputting low current detection signals through output terminal OUT1

Title	Function	Adjustment range	Example of setting
F130	Output terminal function selection 1(OUT1)		26

Note: To put out signals to the terminal OUT2, select the parameter **F131**.

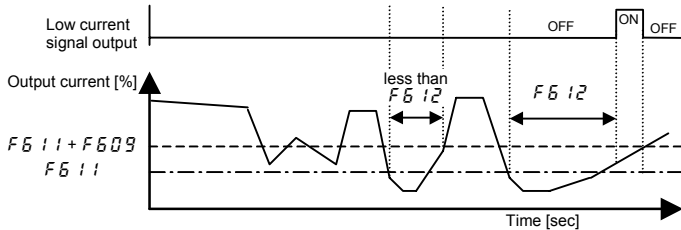

★When **F610=1** (tripping), the inverter will trip if low current lasts for the period of time set with **F612**. After tripping, the low current signal remains ON.

6.26.8 Detection of output short circuit

F6 13 : Selection of short circuit detection at starting

• Function
 Detects a short-circuit on the output side of the inverter.

Title	Function	Adjustment range	Default setting
F6 13	Selection of short circuit detection at starting	0:Each time (standard pulse) 1:Only one time after power is turned on 2:Each time (short pulse) 3:Only one time after power is turn on (short pulse) 4:Each time (Extremely shot-time pulse) 5:Only one time after power is turn on (Extremely shot-time pulse)	0

F6 13 0, 2, 4: Standard — detecting at starting
 1, 3, 5: A check is made once at the first start of operation after the power is turned on or the inverter is reset.

Note: If the input voltage is rather high (480V as a guide) or the inverter is used to operate a high-speed motor, set F6 13 to 2 or 3. Any other setting may cause the motor to malfunction, because a high-speed motor has a very low impedance. If the inverter malfunctions for reasons of impedance even though F6 13 is set to 2 or 3, then set F6 13 to 4 or 5.

6.26.9 Overtorque trip

F6 15 : Overtorque trip selection

F6 16 : Overtorque detection level during power running

F6 17 : Overtorque detection level during regenerative braking

F6 18 : Overtorque detection time

F6 19 : Overtorque detection hysteresis

• Function
 Trips the inverter or issues an alarm if the total time for which torque is above the level set with F6 16/F6 17 reaches the time set with F6 18. Trip information is displayed as "OL."

F6 15=0 (No trip) No tripping (FL is not active).

F6 15=1 (Tripping) The inverter will trip (the failure signal FL will be activated) if a torque larger than F6 16 (during power running) or F6 17 (during regeneration) passes for a time longer than the time set with F6 18.

Title	Function	Adjustment range	Default setting
F6 15	Overtorque trip selection	0:No trip 1:Trip	0
F6 16	Overtorque detection level during power running	0~250 %	150
F6 17	Overtorque detection level during regenerative braking	0~250 %	150
F6 18	Overtorque detection time	0.00~10.00 sec.	0.50
F6 19	Overtorque detection hysteresis	0~100 %	10

Note: Using the output terminal function selection parameter, the inverter can be set so that it outputs overtorque detection signals regardless of the setting of F6 15. => Refer to Section 7.2.2.

<Example of operation>

Output terminal function: 28 Overtorque detection

F6 15=0 (No trip)

Ex.) When outputting overtorque detection signals through output terminal OUT1

Title	Function	Adjustment range	Example of setting
F 130	Output terminal function selection 1(OUT1)	0~255	28

Note: To put out signals to the terminal OUT2, select the parameter F 13 1.



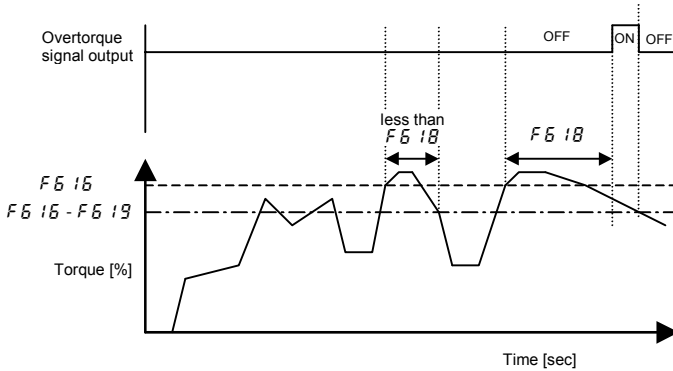

When $F615 = 1$ (tripping), the inverter will trip if overtorque lasts for the period of time set with $F618$. In such a case, the overtorque signal remains ON.

6.26.10 Cooling fan control selection

F620 : Cooling fan control selection

• **Function**
 With this parameter, you can set the condition of cooling fan so that it operates only when the inverter requires cooling, and thus it can be used for a longer period.

$F620=0$: Automatic control of cooling fan, enabled. Operates only when the inverter is in operation.
 $F620=1$: Automatic control of cooling fan, disabled. The cooling fan always operates when the inverter is energized.

★The cooling fan automatically operates whenever the ambient temperature is high, even when the inverter is out of operation.

Title	Function	Adjustment range	Default setting
$F620$	Cooling fan control selection	0:Auto, 1:Always ON	0

Note: For the setting of $F620$ to take effect, the inverter needs to be turned off and turned back on after the setting.

6.26.11 Cumulative operation time alarm setting

F621 : Cumulative operation time alarm setting

• **Function**
 This parameter is to make a setting so that the inverter puts out a signal when its cumulative operation time has reached the time set with $F621$.

* Indication of 0.1 represents 10 hours. Ex.: If 3855 is displayed, the cumulative operation time is 3855 hours.

Title	Function	Adjustment range	Default setting
$F621$	Cumulative operation time alarm setting	0.1~999.9	610.0

■ Setting of output signal

Ex.) When assigning the cumulative operation alarm signal output function to the OUT2 terminal

Title	Function	Adjustment range	Example of setting
$F131$	Output terminal function selection 2 (OUT2)	0~255	56 (Negative logic 57)

6.26.12 Abnormal speed detection

- F622** : Abnormal speed detection time
- F623** : Overspeed detection frequency upper band
- F624** : Overspeed detection frequency lower band

• Function
 These parameters allow you to set the inverter so that, when it is in sensor speed control mode ($P\epsilon = 7$), it always monitors the rotational speed of the motor, even when the motor is at rest, and if the speed remains out of the specified limits for the specified length of time, it outputs an error signal.

Title	Function	Adjustment range	Default setting
F622	Abnormal speed detection time	0.0 1~100.0 sec.	0.0 1
F623	Overspeed detection frequency upper band	0.0: Disabled, 0. 1~30.0 Hz	0.0
F624	Overspeed detection frequency lower band	0.0: Disabled, 0. 1~30.0 Hz	0.0

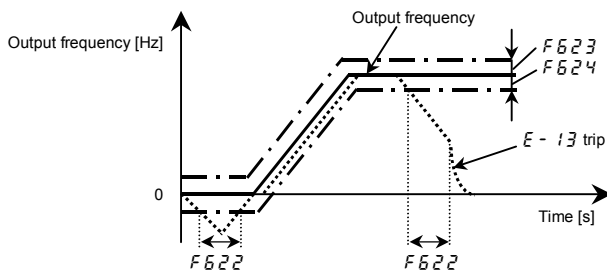

6.26.13 Overvoltage limit operation

- F626** : Overvoltage limit operation level

⇒ For more details, refer to Section 6.15.2.

6.26.14 Undervoltage trip

- F627** : Undervoltage trip selection

• Function
 This parameter is used for selecting the control mode when an undervoltage is detected. (Invalid, while the inverter stops.)

- F627=0: (Disabled) Inverter stops, but does not trip. (FL is not active.)
- F627=1: (Enabled) Inverter stops and is tripped because an undervoltage is detected. (FL is active.)

Title	Function	Adjustment range	Default setting
F627	Undervoltage trip selection	0: Disabled, 1: Enabled	0

6

6.26.15 VI/II analog input wire breakage detection level

F633 : VI/II analog input wire breakage detection level

F644 : Action in the event of VI/II analog input wire breakage

• **Function**

The inverter will trip if the VI/II value remains below the specified value for 0.3 seconds or more. The message "E - 1B" is displayed.

F633=0: Disabled The detection function is disabled.

F633=1~100 If the VI/II input value remains below the specified value for 0.3 seconds or more, the inverter will act in accordance with the setting of **F644**.

Title	Function	Adjustment range	Default setting
F633	VI/II analog input wire breakage detection level	0: None 1~100 %	0
F644	Action in the event of VI/II analog input wire breakage	0: Trip mode 1: The inverter operates the motor at preset speed operation frequency 14.	0

Note: Depending on the degree of deviation of the analog data detected, a wire breakage may be detected within a period shorter than the specified one.

6.26.16 Guide to time of replacement

F634 : Annual average ambient temperature

• **Function**

You can set the inverter so that it will calculate the remaining useful life of the cooling fan, main circuit capacitor and on-board capacitor from the ON time of the inverter, the operating time of the motor, the output current (load factor) and the setting of **F634** and that it will display and send out an alarm through output terminals when each component is approaching the end of its useful life.

Title	Function	Adjustment range	Default setting
F634	Annual average ambient temperature	1: -10~+10°C 2: +11~+20°C 3: +21~+30°C 4: +31~+40°C 5: +41~+50°C 6: +51~+60°C	3

Note 1: Using **F634**, enter the annual average temperature around the inverter. Be careful not to enter the annual highest temperature.

Note 2: Set **F634** at the time of installation of the inverter, and do not change its setting after the start of use. Changing the setting may cause a part replacement alarm calculation error.

6.26.17 Rush current suppression relay activation time

F635 : Rush current suppression relay activation time

• **Function**
 This parameter is used to control the rush current suppressing resistor shorting relay when a direct current is passed or multiple inverters are used with their DC sections connected to each other.

Title	Function	Adjustment range	Default setting
F635	Rush current suppression relay activation time	0.0~2.5 sec.	0.0

The rush current suppressing relay is activated on the expiration of the time limit set with parameter F635 after the voltage in the DC section of the inverter has reached the specified level.

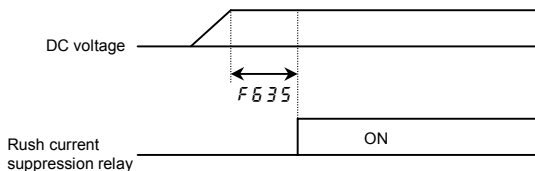

6

6.26.18 Motor thermal protection

F637~**F638** : PTC thermal selection

⇒ For details, refer to Instruction Manual (E6581339) specified in Section 6.36.

6.26.19 Braking resistance overload curve

F639 : Braking resistance overload time

⇒ Refer to 5.19 for details.

6.26.20 Selection of a restart condition for the motor stopped with a mechanical brake

F643 : Brake-equipped motor restart condition selection

Function
 With this function, the motor can be restarted immediately after a stop if it is operated at a frequency of more than 10Hz (20Hz or less) and stopped with a mechanical brake.
 Use this function only when a mechanical brake is used to stop the motor. Using this function for a motor without a mechanical brake, the inverter may be tripped or fail.

Title	Function	Adjustment range	Default setting
F643	Brake-equipped motor restart condition selection	0: Default (no waiting time for frequencies of 10Hz and less) 1: Conditional (no waiting time for frequencies of 20Hz and less)	0

The timing chart in the figure below shows how the motor is operated and stopped with a mechanical brake. By default, restart waiting time is set to prevent the inverter from being tripped because of the immediate restart of the motor which started coasting at a frequency of more than 10Hz and stopped (when the ST function is assigned to the S3 terminal, S3 signal is cut off). This waiting time, however, is not necessary if a mechanical brake is used to stop the motor more reliably. When using a mechanical brake to stop the motor, set this parameter F643 to 1 to allow the motor to restart immediately after a stop if it started coasting at a frequency of 20Hz or less and stopped.

<Ex. : When parameter F643 is set to 1:>

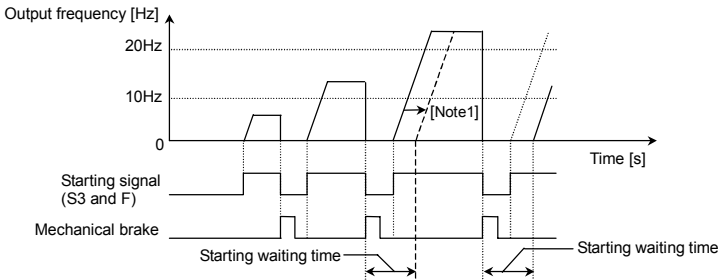

When assigning the ST function to the S3 terminal,
 Set F110 to 0 (to cancel its factory default setting: 0 = ST always active), and
 Set F117 to 0 (to assign the ST function to the S3 terminal).

Note 1: By default, the restart waiting time shown in the figure is set, and the restart of the motor is delayed by the time indicated by the dashed line.

Note 2: If the motor started coasting at a frequency of more than 20Hz, it will restart after the expiration of the waiting time.

6.26.21 Motor PTC thermal protection

F645 : PTC thermal selection

F646 : PTC detection resistor value

• Function
 This function is used to protect motor from overheating using the signal of PTC built-in motor.
 The trip display is "OH2".

[Parameter setting]

Title	Function	Adjustment range	Default setting
F645	PTC thermal selection	0: Disabled 1: Enabled (trip mode) 2: Enabled (alarm mode)	0
F646	PTC detection resistor value	100~9999	3000

[Connection]

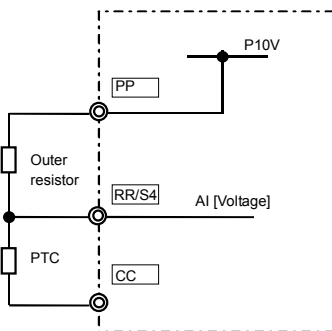

Connect the resistor rated 1/4 watts 3.3k ohm between terminal PP and RR/S4.

6

6.33.24 Protection against a failure of the control power backup device (optional CPS002Z)

F647 : Control power supply backup option failure monitoring

• Function
 If the control power backup device (optional CPS002Z) fails to supply power for some reason or other, the inverter will put out an alarm signal or a trip signal, depending on the setting of this parameter.
 Leaving this parameter disabled may cause the main power supply to be turned on and off endlessly if something unusual occurs, depending on your sequence etc., so you should set this parameter F647 properly when using the optional power backup device.

Title	Function	Adjustment range	Default setting
F647	Control power supply backup option failure monitoring	0: Control power supply not backed up 1: Control power supply backed up (alarm in the event of a failure) 2: Control power supply backed up (tripping in the event of a failure)	0

■ **F547=0**: If control power is not backed up with an external backup device:

Select this setting if an external backup device is not connected to the inverter's control terminals +SU and CC.

■ **F547=1**: If control power is backed up with an external backup device (alarm signal output):

Be sure to select this setting if an external backup device is connected to the inverter's control terminals +SU and CC, and if the main power supply is turned on and off endlessly for reasons of sequence, as shown below, in the event the external power backup device fails.

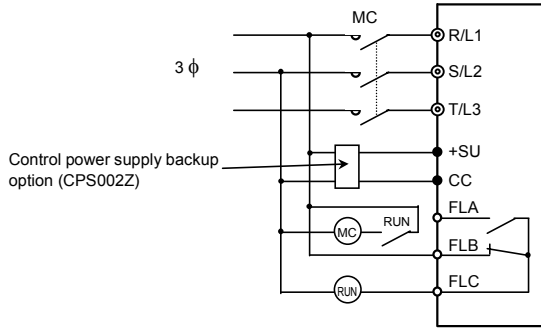

<Example of a situation in which the main power supply is turned on and off endlessly>

In the example of connection shown above, if the control power backup device (optional) fails and becomes incapable of supplying control power, control power is supplied from the inverter's main circuit and operation is continued without interruption. If the inverter is tripped under these circumstances because of a ground fault or overcurrent (and if **F547** is set to **0**):

- (1) The FL relay is triggered and the main power supply is shut off by the MC.
- ↓
- (2) As a result of shutoff by the MC, the voltage in the inverter's main circuit and control circuit drop.
- ↓
- (3) As a result of a drop in control voltage, the FL relay recovers from a trip.
- ↓
- (4) The release of the FL relay turns the MC back on.
- ↓
- (5) Operation is restarted and if the problem causing the inverter to be tripped is not eliminated, the inverter is tripped again, the situation in (1) arises again, and thus the above cycle of operation is repeated endlessly.

If **F547** is set to **1**, however, the inverter will cut off the power supply, let the motor coast, and raise a **CCFF** alarm in the event something unusual (voltage drop) occurs with the power supplied through the +SU and CC terminals. Once the **CCFF** alarm has been raised, the inverter is not reset even if the control voltage returns to its normal level. To reset the inverter, turn off the main circuit power supply.

This is the way in which this setting (power reset) prevents the power from being turned on and off endlessly by the mechanism described above.

■ **F547=2**: If control power is backed up with an external backup device (trip signal output):

This setting trips the inverter in the event something unusual (voltage drop) occurs with the external control power backup device. Trip code **E-29** is displayed.

In the event of this trip, unlike ordinary trips, the inverter is held tripped regardless of the setting of **F502** (inverter trip retention selection). By holding the inverter tripped, this setting prevents the power from being turned on and off endlessly.

This setting is effective only when the inverter is used in a standard connection shown in Chapter 2.

Note: Even if **F547** is set to **0** while control power is backed up, the inverter will cut off the power supply and issue a **CCFF** alarm in the event the backup device fails during operation.

If the backup device is already faulty when it is turned on, it will not be recognized to be faulty even if this setting is selected.

6.27 Forced fire-speed control function

F650 : Forced fire-speed control function

F294 : Preset speed operation frequency 15 (Forced operation frequency)

• Function

Forced fire-speed control is used when operating the motor at the specified frequency in case of an emergency. Two kind of operation are selectable by assignment of terminal board function.

(1) Input terminal function **56.57** (Forced continuous operation) : Input signal is kept to hold once signal is ON.

Motor runs at the speed set by the parameter "**F294**".

Operation is continued in the event of a minor failure, and it is continued as far as the retry function permits in the event of a major failure.



(2) Input terminal function **58.59** (Specified speed operation) : Input signal is kept to hold once signal is ON.

Motor runs at the speed set by the parameter "**F294**".

Operation will be stopped if the inverter is tripped.

Note: To stop operation, an emergency stop signal needs to be given or the main circuit needs to be turned off.

Title	Function	Adjustment range	Default setting
F650	Forced fire-speed control selection	0: Disabled 1: Enabled	0
F294	Preset speed operation frequency 15 (Forced operation frequency)	LL ~ UL Hz	0.0

When setting the parameter "**F650**", "**FIRE**" is displayed by pressing  key. It can be set by continuing the  key for 2 seconds.

[Setting the forced operation input terminal (RES-CC)]

The control terminal "RES" (The default setting is "B: reset function") shall be assigned to "Forced continuous operation".

Title	Function	Adjustment range	Setting value
F114	Input terminal function selection 4 (RES)	0 ~ 135	56.57 (Forced continuous operation)

6.28 Low torque detection signals

- F651** : Undertorque detection selection
- F652** : Undertorque detection level during power running
- F653** : Undertorque detection level during regenerative braking
- F654** : Undertorque detection time
- F655** : Undertorque detection hysteresis

• **Function**
 If the torque remains below the level specified with **F652** or **F653** for a period longer than that specified with **F654**, the inverter will be tripped. Then the trip message "UL" appears.

F651 = 0: Alarm signal output (No tripping)

With an output terminal function selection parameter, the inverter can be set so as to issue an undertorque alarm.

The output terminal function number is 142 or 143 (reverse video).

F651 = 1: Trip signal output

If the torque is found to be below the value set with **F652** or **F653** for a period longer than that set with **F654**, the inverter will be tripped. (FL activated under a fault signal)

Title	Function	Adjustment range	Default setting
F651	Undertorque detection selection	0: Alarm mode 1: Trip mode	0
F652	Undertorque detection level during power running	0~250 %	0
F653	Undertorque detection level during regenerative braking	0~250 %	0
F654	Undertorque detection time	0.00~10.00 sec.	0.50
F655	Undertorque detection hysteresis	0~100 %	10

<Example of operation>

Output terminal function: 142 (Low torque detection)

F651 = 0 (Alarm output)

Ex.) When outputting low torque detection signals through output terminal OUT1

Title	Function	Adjustment range	Example of setting
F130	Output terminal function selection 1(OUT1)	0~255	142

Note: To put out signals to the terminal OUT2, select the parameter **F131**.

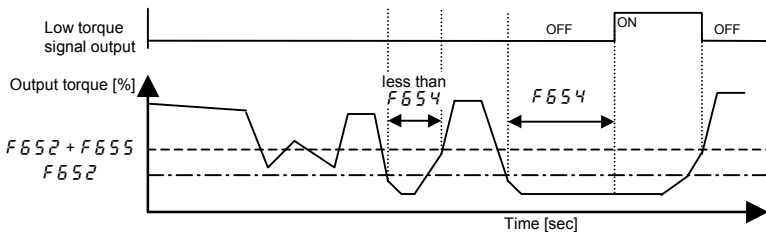

★When **F651 = 1** (tripping), the inverter will trip if low torque lasts for the period of time set with **F654**. After tripping, the low torque signal remains ON.

6.29 Override

F550 : Override addition input selection

F551 : Override multiplication input selection

• **Function**
 These parameters are used to adjust reference frequencies by means of external input.

Title	Function	Adjustment range	Default setting
F550	Override addition input selection [Hz]	0: Disabled 1: VI/II (voltage/current input) 2: RR/S4 (potentiometer/voltage input) 3: RX (voltage input) 4: Operation panel input enabled (including LED/LCD option input) 5: 2-wire RS485 input enabled 6: 4-wire RS485 input enabled 7: Communication option input enabled 8: Option1 A11 (differential current input) 9: Option1 A12 (voltage/current input) i 0: Up/Down frequency i 1: Option1 RP pulse input i 2: Option1 high-speed pulse input i 3: Option1 binary/BCD input	0
F551	Override multiplication input selection [%]	0: Disabled 1: VI/II (voltage/current input) 2: RR/S4 (potentiometer/voltage input) 3: RX (voltage input) 4: - 5: Option1 A11	0

The override functions calculate output frequency by the following expression:

$$\text{Frequency command value} \times \left(1 + \frac{\text{Value [\%] selected with F551}}{100}\right) + \text{Value [Hz] selected with F550}$$

1) Additive override

In this mode, an externally input override frequency is added to operation frequency command.

[Ex.1: RR/S4 (Reference frequency), VI/II (Override input)] [Ex.2: RX (Reference frequency), VI/II (Override input)]

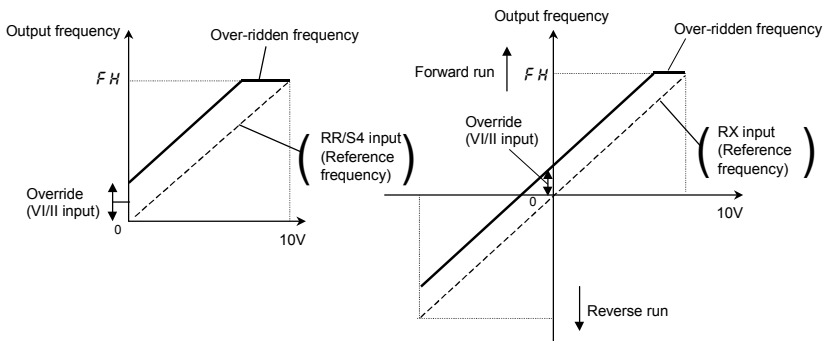

6

Ex.1:
F 5 5 0 = 1 (VI/II input), *F 5 5 1 = 0* (disabled)

Output frequency = Reference frequency + Override (VI/II input [Hz])

Ex.2:
F 5 5 0 = 1 (VI/II input), *F 5 5 1 = 0* (disabled)

Output frequency = Reference frequency + Override (VI/II input [Hz])

2) Multiplicative override

In this mode, each output frequency is multiplied by an externally override frequency.

[Ex.1: RR/S4 (Reference frequency), VI/II (Override input)] [Ex.2: RX (Reference frequency), VI/II (Override input)]

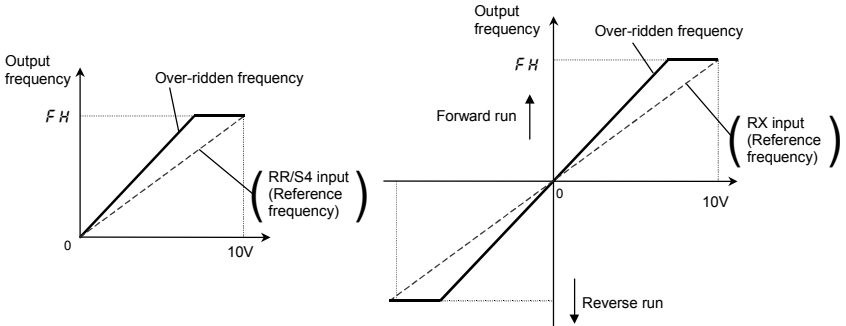

Ex.1:
F 5 5 0 = 0 (Disabled), *F 5 5 1 = 1* (VI/II input), *F 1 0 1 = 2* (RR/S4 input), *F H = 8 0 0*, *U L = 8 0 0*
 RR/S4 input, (*F 2 1 0 = 0*, *F 2 1 1 = 0 0*, *F 2 1 2 = 1 0 0*, *R u F 2 = 8 0 0*)
 VI/II input (*F 2 0 1 = 0*, *F 2 0 5 = 0*, *F 2 0 3 = 1 0 0*, *F 2 0 6 = 1 0 0*)
 ⇒ Setting of RR/S4 input: Refer to Section 7.3.1, Setting of VI/II input: Refer to Section 7.3.2.

Output frequency = Reference frequency × {1 + Override (VI/II input [%]/100)}

Ex.2:
F 5 5 0 = 0 (Disabled), *F 5 5 1 = 1* (VI/II input), *F 1 0 1 = 3* (RX input), *F H = 8 0 0*, *U L = 8 0 0*
 RX input (*F 2 1 6 = 0*, *F 2 1 7 = 0 0*, *F 2 1 8 = 1 0 0*, *F 2 1 9 = 8 0 0*)
 VI/II input (*F 2 0 1 = 0*, *F 2 0 2 = 0*, *F 2 0 3 = 1 0 0*, *F 2 0 6 = 1 0 0*)
 ⇒ Setting of RX input: Refer to Section 7.3.3, Setting of VI/II input: Refer to Section 7.3.2.

Output frequency = Reference frequency × {1 + Override (VI/II input [%]/100)}

6.30 Adjustment parameters

6.30.1 Pulse train output for meters

F669 : Logic output/pulse output selection (OUT1)

F676 : Pulse output function selection

F677 : Selection of number of pulses

• **Function**
 Pulse trains can be sent out through the OUT1-NO output terminals.
 To do so, it is necessary to select a pulse output mode and specify the number of pulses.

Set the SW4 to pulse output (PULS).

Ex.) When operations frequencies (0 to 60Hz) are put out by means of 0 to 10kHz

$FH=50.0, F669=1, F676=0, F677=10.00$

The pulse will change between 0 and 10kHz according to the operations frequencies between 0 and 60Hz.

⇒ See the circuit diagram shown at the bottom of page B-15.

Title	Function	Adjustment range	Default setting
F669	Logic output/pulse output selection (OUT1)	0:Logic output 1:Pulse output	0
F676	Pulse output function selection	0:Output frequency 1:Frequency command value 2:Output current 3:Input voltage (DC detection) 4:Output voltage 5:Compensated frequency 6:Speed feedback (realtime value) 7:Speed feedback (1-second filter) 8:Torque 9:Torque command 11:Torque current 12:Exiting current 13:PID feedback value 14:Motor overload factor (OL2 data) 15:Inverter overload factor (OL1 data) 16:Regenerative braking resistance overload factor (OLr data) 17:Regenerative braking resistor load factor (% ED) 18:Input power 19:Output power 23:Optional AI2 input 24:RR/S4 input 25:VI/II input 26:RX input 27:Optional AI1 input 28:FM output 29:AM output 30:Fixed output 1 31:Communication data output 32:Fixed output 2 33:Fixed output 3 34:Cumulative input power 35:Cumulative output power 46:My function monitor 1 47:My function monitor 2 48:My function monitor 3 49:My function monitor 4	0
F677	Selection of number of pulses	1.00~43.20 kHz	3.84

Note: The pulse length is fixed. Therefore, the duty is variable.

6

6.30.2 Setting of optional meter outputs

F672 ~ **F675**, **F688** ~ **F693** : Meter output settings

⇒ For details, refer to Instruction Manual (E6581341) specified in Section 6.36.

6.30.3 Calibration of analog outputs

F681 : FM voltage/current output switching

F682, **F683** : FM output gradient characteristic and bias adjustment

F685, **F686** : AM output gradient characteristic and bias adjustment

•Function
 Output signals from FM/AM terminals are analog voltage signals. Their standard setting range is from 0 to 10Vdc.
 The output current from terminal FM can be changed to 0 to 20mA (or 4 to 20mA) by changing the settings of terminal SW2 and a parameter.

[Parameter setting]

Title	Function	Adjustment range	Default setting
F681	FM voltage/current output switching	0: Voltage 0~10V output 1: Current 0~20mA output	0
F682	FM output gradient characteristic	0: Negative gradient (descending) 1: Positive gradient (ascending)	1
F683	FM bias adjustment	-10.0 ~ 100.0 %	0.0
F685	AM output gradient characteristic	0: Negative gradient (descending) 1: Positive gradient (ascending)	1
F686	AM bias adjustment	-10.0 ~ 100.0 %	0.0

Note: To switch to 0-20mA (4-20mA), set F681 to 1.

■ FM terminals setting example

SW2=OFF F681, F682=1 F683=0 (%)

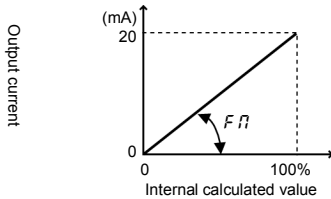

SW2=OFF F681, F682=1 F683=20 (%)

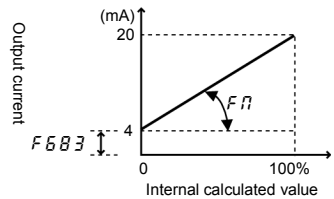

SW2=OFF F681=1 F682=0 F683=100 (%)

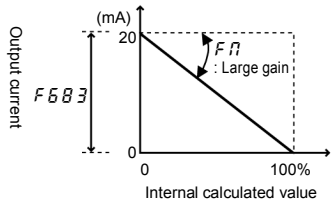

SW2=OFF F681=1 F682=0 F683=100 (%)

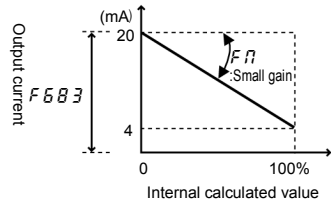

★The analog output inclination can be adjusted using the parameter F683

★For code data 50 to 64, negative inclination is invalid.

6.31 Operation panel parameter

6.31.1 Prohibition of key operations and parameter settings

F700	: Parameter write protect selection
F730	: Operation panel frequency setting prohibition selection
F734	: Operation panel emergency stop operation prohibition selection
F735	: Operation panel reset operation prohibition selection
F736	: Prohibition of change of $CnOdIFnOd$ during operation
F737	: All key operation prohibition

• Function

These parameters allow you to prohibit the operation of the RUN and STOP keys on the operation panel and the change of parameters. Using these parameters, you can also prohibit various key operations.

[Parameter setting]

Title	Function	Adjustment range	Default setting
F700	Parameter write protect selection	0:Permit, 1:Prohibit	0
F730	Operation panel frequency setting prohibition selection	0:Permit, 1:Prohibit	0
F734	Operation panel emergency stop operation prohibition selection	0:Permit, 1:Prohibit	0
F735	Operation panel reset operation prohibition selection	0:Permit, 1:Prohibit	0
F736	Prohibition of change of $CnOdIFnOd$ during operation	0:Permit, 1:Prohibit	1
F737	All key operation prohibition	0:Permit, 1:Prohibit	0

Note: For the setting of **F737** to take effect, the inverter needs to be turned off and turned back on after the setting.

■ Resetting method

- 1) Canceling the **F700** prohibition setting

The setting of only parameter **F700** can be changed at any time, even if it is set to 1.

- 2) Canceling the **F737** prohibition setting

When this parameter is set to 1 (key operation prohibited), press and hold down the **ENT** key for 5 seconds or more. The message $UnOd$ appears and this setting is canceled temporarily to enable key operation.

To cancel this setting permanently, change the setting of **F737** directly.

6.31.2 Displaying the rotational speed of the motor or the line speed

- F702** : Frequency free unit display magnification
- F703** : Frequency free unit conversion selection
- F705** : Free unit display gradient characteristic
- F706** : Free unit display bias

• Function
 The frequency or any other item displayed on the monitor can be converted freely into the rotational speed of the motor, the operating speed of the load, and so on. Using these parameters, the units of the amounts of processing and feedback in PID control can also be changed.

The value obtained by multiplying the displayed frequency by the **F702** set value will be displayed as follows:

Value displayed = **Monitor-displayed or parameter-set frequency** × **F702**

1) Displaying the motor speed

To switch the display mode from 60Hz (default setting) to 1800 min⁻¹ (the rotating speed of the 4P motor)

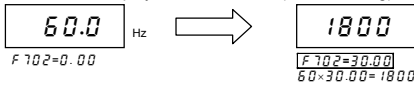

2) Displaying the speed of the loading unit

To switch the display mode from 60Hz (default setting) to 6 m/min⁻¹ (the speed of the conveyer)

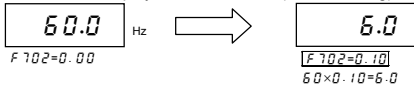

Note: This parameter displays the inverter output frequency as the value obtained by multiplying it by a positive number. Even when the actual speed of the motor changes according to the particular changes in load, the output frequency will always be displayed.

Title	Function	Adjustment range	Default setting
F702	Frequency free unit display magnification	0.00:OFF 0.0 1~200.0	0.00
F703	Frequency free unit conversion selection	0:All frequencies display free unit conversion 1:PID frequencies free unit conversion	0
F705	Free unit display gradient characteristic	0:Negative gradient (descending) 1:Positive gradient (ascending)	1
F706	Free unit display bias	0.00~FH Hz	0.00

* The **F702** converts the following parameter settings:

In case of **F703=0**

- Free unit Frequency monitor display
 Frequency-Related parameters *FH, UL, LL, RuF2, R1F2, S_r 1~5r 7, F100, F101, F102, F202, F208, F211, F217, F219, F223, F225, F229, F231, F235, F237, F240, F241, F242, F243, F244, F250, F260, F265, F267, F268, F270~F275, F287~F294, F321, F322, F355, F370, F371, F505, F606, F623, F624, F812, F814, F923~F927*

In case of **F703=1**

- Free unit PID control -Related parameters *F364, F365, F367, F368*



■ An example of setting: When FH is 80, and $F702$ is 10.00

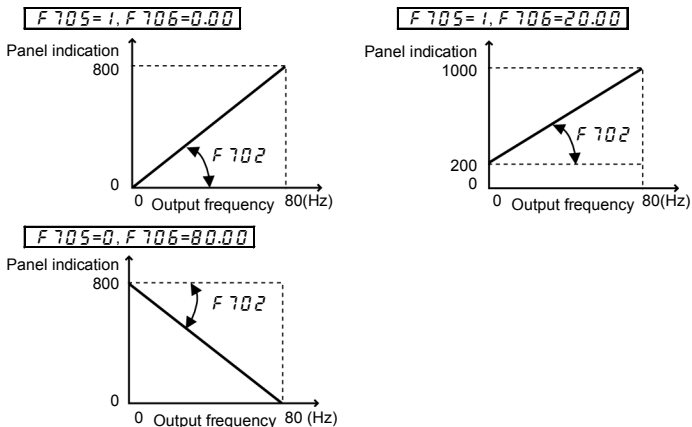

6.31.3 Changing the steps in which the value displayed changes

$F707$: Changing step selection 1 (pressing a panel key once)

$F708$: Change step selection 2 (panel display)

• Function

These parameters are used to specify steps in which the command value or standard monitor output frequency displayed on the panel changes each time you press the up or down key to set a frequency on the operation panel.

Note: The settings of these parameters have no effect when the free unit selection ($F702$) is enabled.

■ When $F707$ is not 0.00, and $F708$ is 0 (disabled).

Under normal conditions, the panel frequency command value increases in steps of 0.1Hz each time you press the Δ key. If $F707$ is not 0.00, the frequency command value will increase by the value with $F707$ each time you press the Δ key. Similarly, it will decrease by the value set with $F707$ each time you press the ∇ key.

In this case, the output frequency displayed in standard monitor mode changes in steps of 0.1Hz, as usual.

■ When $F707$ is not 0.00, and $F708$ is not 0.

The value displayed on the panel also can be changed in steps.

$$\text{Output frequency displayed in standard monitor} = \text{Internally output frequency} \times \frac{F708}{F707}$$

Title	Function	Adjustment range	Default setting
$F707$	Changing step selection 1 (pressing a panel key once)	0.00:Disabled 0.0 1~FH Hz	0.00
$F708$	Changing step selection 2 (panel display)	0:Disabled 1~255	0

■ Example of setting 1

Set $F707 = 10.00$ [Hz]:

Each time you press the Δ key, Each time the frequency setting $F\zeta$ changes in steps of 10.0Hz: 0.0 \rightarrow 10.0 \rightarrow 20.0 \rightarrow ... \rightarrow 60.0 [Hz]. This function comes in very handy when operating the load at limited frequencies that change in steps of 1 Hz, 5Hz, 10Hz, and so on.

■ Example of setting 2

Set $F707 = 1.00$ [Hz], $F708 = 1$:

Each time you press the Δ key, the frequency setting $F\zeta$ changes in steps of 1 Hz: 0 \rightarrow 1 \rightarrow 2 \rightarrow ... \rightarrow 60 [Hz] and also the value displayed on the operation panel changes in steps of 1. Use these settings to hide decimal fractions. And also the value displayed on the operation panel changes in steps of 1. Use these settings to hide decimal fractions.

6.31.4 Changing the standard monitor display

F710 : Standard monitor display selection

F711 ~ **F714** : Status monitor 1~4 display selection

These parameters are used to select the item to be displayed when the power turned on and also to change items displayed in status monitor mode.

⇒ For details, refer to Section 8.3.

6.31.5 Selection of operation panel stop pattern

F721 : Operation panel stop pattern selection

• **Function**

This parameter are used to select a mode in which the motor started by pressing the **(RUN)** key on the operation panel is stopped when the **(STOP)** key is pressed.

1) Deceleration stop

The motor stops in the deceleration time set with the parameter *dEC* (or *F501*).

2) Coast stop

The output of the inverter is cut off. The motor comes to a stop after coasting for a while by inertia. Depending on the load, the motor may keep running for a good long time.

[Parameter setting]

Title	Function	Adjustment range	Default setting
<i>F721</i>	Operation panel stop pattern selection	<i>0</i> :Deceleration stop <i>1</i> :Coast stop	<i>0</i>



6.32 Tracing functions

F740 : Trace selection

F743 : Trace data 2

F741 : Trace cycle

F744 : Trace data 3

F742 : Trace data 1

F745 : Trace data 4

• **Function**

These parameters are used to memorize and read out the data collected at the time of tripping or triggering.

Up to 4 kinds of data can be selected from 64 kinds of data, and the data collected at 100 consecutive points can be stored in memory as trace data.

Here is the time at which trace data is acquired.

- Tripping: Data collected before the occurrence
- Triggering: Data collected after triggering

Note: To read data on a PC.

Title	Function	Adjustment range	Default setting
<i>F740</i>	Trace selection	<i>0</i> :Deselect <i>1</i> :At tripping <i>2</i> :At triggering	<i>1</i>
<i>F741</i>	Trace cycle	<i>0</i> :4ms <i>1</i> :20ms <i>2</i> :100ms <i>3</i> :1s <i>4</i> :10s	<i>2</i>
<i>F742</i>	Trace data 1	<i>0</i> ~ <i>49</i>	<i>0</i>
<i>F743</i>	Trace data 2	<i>0</i> ~ <i>49</i>	<i>1</i>
<i>F744</i>	Trace data 3	<i>0</i> ~ <i>49</i>	<i>2</i>
<i>F745</i>	Trace data 4	<i>0</i> ~ <i>49</i>	<i>3</i>

1) To acquire trace data at the occurrence of tripping: $F740=1$

(Examples of current date output)

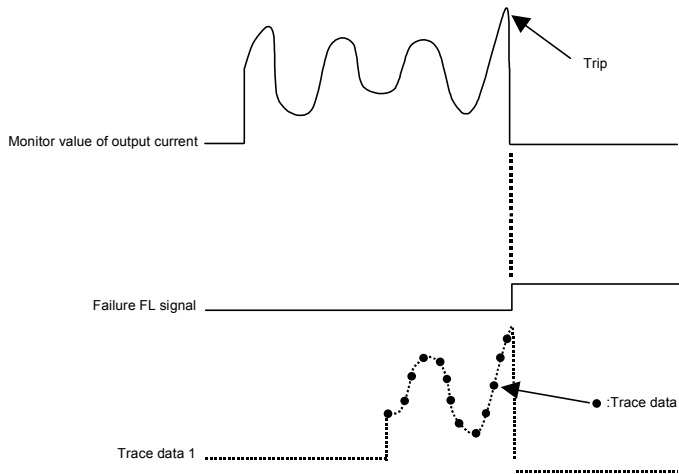

6

2) To acquire trace data at the time of triggering: $F740=2$

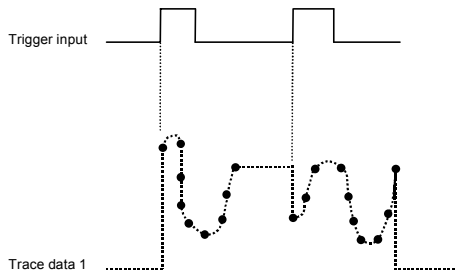

Ex.) When using the RR/S4 terminal as the tracing back trigger signal terminal

Title	Function	Adjustment range	Example of setting
$F118$	Input terminal function selection 8 (RR/S4)	0~135	76

Note 1: If the inverter trips when no trigger signal is given, trace data is overwritten with tripping data.

Note 2: Trace data is overwritten each time a trigger signal is given.

Note 3: Do not disconnect the control power supply or the main circuit power supply to hold a trace data after 15 seconds of tripping.

[Setup values of F 742~F 745]

Default setting	Communication No.	Trace (monitor) function	Communication unit at tracing
0	FD00	Output frequency	0.01Hz
1	FD02	Frequency command value	0.01Hz
2	FD03	Output current	0.01%
3	FD04	Input voltage (DC detection)	0.01%
4	FD05	Output voltage	0.01%
5	FD15	Compensated frequency	0.01Hz
6	FD16	Speed feedback (real-time value)	0.01Hz
7	FD17	Speed feedback (1-second filter)	0.01Hz
8	FD18	Torque	0.01%
9	FD19	Torque command	0.01%
11	FD20	Torque current	0.01%
12	FD21	Exciting current	0.01%
13	FD22	PID feedback value	0.01
14	FD23	Motor overload factor (OL2 data)	0.01%
15	FD24	Inverter overload factor (OL1 data)	0.01%
16	FD25	Regenerative braking resistance overload factor (OLr data)	1%
17	FD28	Regenerative braking resistor load factor (% ED)	1%
18	FD29	Input power	0.01kW
19	FD30	Output power	0.01kW
23	FE39	Optional AI2 input	0.01%
24	FE35	RR/S4 input	0.01%
25	FE36	VI/II input	0.01%
26	FE37	RX input	0.01%
27	FE38	Optional AI1 input	0.01%
28	FE40	FM output	0.01%
29	FE41	AM output	0.01%
34	FE76	Integral input power	0.01kWhr
35	FE77	Integral output power	0.01kWhr
46	FE60	My function monitor 1	1c
47	FE61	My function monitor 2	1c
48	FE62	My function monitor 3	1c
49	FE63	My function monitor 4	1c

■ Acquisition of trace data

Trace data is acquired through a communication device.

The VF-PS1 supports the protocols listed below.

- RS485 (Standard protocol)

■ Trace data communication number

Communication No.	Function	Minimum setting /readout unit	Setting/readout range	Default setting
E000	Trace data 1~4 pointer	!! !	0~99	0
E100	Data 1 of trace data 1	!! !	0~FFFF	0
	Data 2~99 of trace data 1	!! !	0~FFFF	0
E199	Data 100 of trace data 1	!! !	0~FFFF	0
E200	Data 1 of trace data 2	!! !	0~FFFF	0
	Data 2~99 of trace data 2	!! !	0~FFFF	0
E299	Data 100 of trace data 2	!! !	0~FFFF	0
E300	Data 1 of trace data 3	!! !	0~FFFF	0
	Data 2~99 of trace data 3	!! !	0~FFFF	0
E399	Data 100 of trace data 3	!! !	0~FFFF	0
E400	Data 1 of trace data 4	!! !	0~FFFF	0
	Data 2~99 of trace data 4	!! !	0~FFFF	0
E499	Data 100 of trace data 4	!! !	0~FFFF	0

Ex.) When operation frequency data is acquired through a communication device

Data acquired (*F 4 0*)h=8000 ⇒ 8000×0.01Hz=80.0Hz

■ Relationship between pointer and data

The table below shows the relationship between pointer (E000 set value) and trace data (1 to 4).

Pointer (E000 set value)	0	1	2	~	98	99
Trace data 1 (E100~E199)	E100	E101	E102	~	E198	E199
Trace data 2 (E200~E299)	E200	E201	E202	~	E298	E299
Trace data 3 (E300~E399)	E300	E301	E302	~	E398	E399
Trace data 4 (E400~E499)	E400	E401	E402	~	E498	E499

<Example of setting> If E000 is set to 2:

	(Earliest data)	(Latest data)
Trace data 1	E102 ~ E199	E100, E101
Trace data 2	E202 ~ E299	E200, E201
Trace data 3	E302 ~ E399	E300, E301
Trace data 4	E402 ~ E499	E400, E401

Note 1: Use the parameters *F 7 4 2* through *F 7 4 5* to specify the types of trace data (1 to 4).

Note 2: Communication numbers E000 is automatically incremented by the inverter when data is traced continuously.

* In ordinary cases, these parameters do not need to be rewritten.

6.33 Integrating wattmeter

F 7 4 8 : Integrating wattmeter retention selection

F 7 4 9 : Integrating wattmeter display unit selection

• Function

At the main power off, it is selectable whether retention of integral output power values or not. And also, the display unit is selectable.

The integrating wattmeter display can be cleared by external input signal by assignment of the terminal function. Input terminal function 74, 75 (Integrating wattmeter display clear)

Title	Function	Adjustment range	Default setting
<i>F 7 4 8</i>	Integrating wattmeter retention selection	0: Disabled 1: Enabled	1
<i>F 7 4 9</i>	Integrating wattmeter display unit selection	0: 1 = 1 kWh 1: 1 = 10 kWh 2: 1 = 100 kWh 3: 1 = 1000 kWh 4: 1 = 10000 kWh	According to model ⇒ Refer to page K-41.

6.34 Communication function

6.34.1 2-wire RS485/4-wire RS485

F800	: Communication speed (2-wire RS485)	
F801	: Parity (common to 2-wire RS485 and 4-wire RS485)	
F802	: Inverter number (common)	
F803	: Communications time-out time (common to 2-wire RS485 and 4-wire RS485)	
F804	: Communications time-out action (common to 2-wire RS485 and 4-wire RS485)	
F805	: Send waiting time (2-wire RS485)	
F806	: Master/slave setting for Inverter-to-inverter communications (common to 2-wire RS485)	
F807	: Protocol selection (2-wire RS485)	
F810	: Frequency point selection	
F811	: Point 1 setting	
F812	: Point 1 frequency	
F813	: Point 2 setting	
F814	: Point 2 frequency	
F820	: Communication speed (4-wire RS485)	
F825	: Send waiting time (4-wire RS485)	
F826	: Inverter-to-inverter communication setting (4-wire RS485)	
F829	: Protocol selection (4-wire RS485)	
F870	, F871	: Block write data 1, 2
F875	, F879	: Block read data 1~5
F880	: Free notes	

⇒ For details, see Instruction Manual (E6581413) specified in Section 6.36.

• Function

These parameters allow you to connect the inverter to a higher-level system (host) and to set up a network for data communications between inverters. They make it possible for the inverter to be linked to a computer and to carry out data communications with other inverters.

<Computer link function>

This function allows the inverter to carry out data communications with a higher-level system (host).

- (1) Monitoring inverter status (such as the output frequency, current, and voltage)
- (2) Sending RUN, STOP and other control commands to the inverter
- (3) Reading, editing and writing inverter parameter settings

<Inverter-to-inverter communication function>

This function allows you to set up a network that makes it possible to carry out proportional operation of multiple inverters (without using a computer).

- ★Timer function Designed to detect broken communications cables. If no data is sent to the inverter within the specified time, this function trips the inverter ("E r S" is displayed on the display panel) or gives an alarm ("L" is displayed).
- ★Broadcast function Refers to the function of issuing a command (data writing) to multiple inverters in one session.
- ★Inverter-to-inverter communication function .. Refers to the function that enables the master inverter to send the data selected with a parameter to all slave inverters on the same network. This function allows you to set up a network that makes it possible to carry out synchronized operation or proportional operation (setting of point frequencies) in an abbreviated manner.

1) 2-wire RS485

The 2-wire RS485 device on the operation panel and the 4-wire RS485 device on the control circuit terminal block are intended for data communications between inverters. To use an optional part for the RS485 device, it should be connected to the communication connector (RJ45) on the operation panel. Through the 2-wire RS485 device and a USB device (optional), the inverter can be linked to a computer.

★Here are the parts optionally available for the 2-wire RS485 device.

- Optional USB-to-Serial conversion unit (Model: USB001Z)
Inverter-to-RS485/USB device interconnect cable (Model: CAB0011 (1m), CAB0013 (3m), CAB0015 (5m))
RS485/USB device-to-computer interconnect cable. Use a commercially available USB1.1 or 2.0 cable. (Type: A-B, Cablelength: 0.25~1.5m)
- Optional LED Remote Keypad (Model: RKP002Z)
Communication cable (Model:CAB0011 (1m), CAB0013 (3m), CAB0015 (5m))
- Optional LCD Remote Keypad (Model: RKP004Z)
LCD special cable (Model:CAB0071 (1m), CAB0073 (3m), CAB0075 (5m), CAB00710 (10m))

Note: Do not connect the cable (CAB0011, 0013 or 0015) from the communication device to the optional LCD Remote Keypad. Or the inverter or the optional LCD Remote Keypad could be damaged.

■ Setting for issuing run/stop commands from an external control device

Title	Function	Adjustment range	Default setting	Example of setting
$\overline{C} \overline{R} \overline{0} \overline{d}$	Command mode selection	$\overline{0} \sim 4$	$\overline{0}$ (Terminal input enabled)	$\overline{2}$ (2-wire RS485)

Note:When parameter $\overline{F} \overline{B} \overline{0} \overline{5}$ (setting for communications between inverters) is used, the setting $\overline{C} \overline{R} \overline{0} \overline{d} = \overline{2}$ cannot be used for slave inverters.

■ Setting for issuing speed commands from an external control device

Title	Function	Adjustment range	Default setting	Example of setting
$\overline{F} \overline{R} \overline{0} \overline{d}$	Frequency setting mode selection 1	$\overline{1} \sim \overline{1} \overline{2}$	$\overline{2}$ (RR/S4 input)	$\overline{5}$ (2-wire RS485)

■ Communication parameters (2-wire RS485)

These parameters allow you to change the communication speed, parity check setting, inverter number, communication error trip timer setting, etc. from the operation panel or an external control device.

Title	Function	Adjustment range	Default setting																														
$\overline{F} \overline{B} \overline{0} \overline{0}$	Communication speed (2-wire RS485)	$\overline{0}$:9600 bps, $\overline{1}$:19200 bps, $\overline{2}$:38400 bps	$\overline{1}$																														
$\overline{F} \overline{B} \overline{0} \overline{1}$	Parity (common to 2-wire RS485 and 4-wire RS485)	$\overline{0}$:Non parity, $\overline{1}$:Even parity $\overline{2}$:Odd parity	$\overline{1}$																														
$\overline{F} \overline{B} \overline{0} \overline{2}$	Inverter number (common)	$\overline{0} \sim \overline{2} \overline{4} \overline{7}$	$\overline{0}$																														
$\overline{F} \overline{B} \overline{0} \overline{3}$	Communications time-out time (common to 2-wire RS485 and 4-wire RS485)	$\overline{0}$:OFF $\overline{1} \sim \overline{1} \overline{0} \overline{0}$ sec.	$\overline{0}$																														
$\overline{F} \overline{B} \overline{0} \overline{4}$	Communications time-out action * (common to 2-wire RS485 and 4-wire RS485)	Setting <table border="1"> <tr> <th>Setting</th> <th>2-wire RS485</th> <th>4-wire RS485</th> </tr> <tr> <td>$\overline{0}$</td> <td>No action</td> <td>No action</td> </tr> <tr> <td>$\overline{1}$</td> <td>Alarm</td> <td>No action</td> </tr> <tr> <td>$\overline{2}$</td> <td>Trip</td> <td>No action</td> </tr> <tr> <td>$\overline{3}$</td> <td>No action</td> <td>Alarm</td> </tr> <tr> <td>$\overline{4}$</td> <td>Alarm</td> <td>Alarm</td> </tr> <tr> <td>$\overline{5}$</td> <td>Trip</td> <td>Alarm</td> </tr> <tr> <td>$\overline{6}$</td> <td>No action</td> <td>Trip</td> </tr> <tr> <td>$\overline{7}$</td> <td>Alarm</td> <td>Trip</td> </tr> <tr> <td>$\overline{8}$</td> <td>Trip</td> <td>Trip</td> </tr> </table>	Setting	2-wire RS485	4-wire RS485	$\overline{0}$	No action	No action	$\overline{1}$	Alarm	No action	$\overline{2}$	Trip	No action	$\overline{3}$	No action	Alarm	$\overline{4}$	Alarm	Alarm	$\overline{5}$	Trip	Alarm	$\overline{6}$	No action	Trip	$\overline{7}$	Alarm	Trip	$\overline{8}$	Trip	Trip	$\overline{8}$
Setting	2-wire RS485	4-wire RS485																															
$\overline{0}$	No action	No action																															
$\overline{1}$	Alarm	No action																															
$\overline{2}$	Trip	No action																															
$\overline{3}$	No action	Alarm																															
$\overline{4}$	Alarm	Alarm																															
$\overline{5}$	Trip	Alarm																															
$\overline{6}$	No action	Trip																															
$\overline{7}$	Alarm	Trip																															
$\overline{8}$	Trip	Trip																															
$\overline{F} \overline{B} \overline{0} \overline{5}$	Send waiting time (2-wire RS485)	$\overline{0} \overline{0} \overline{0}$:Normal communications $\overline{0} \overline{0} \overline{1} \sim \overline{2} \overline{0} \overline{0}$ sec.	$\overline{0} \overline{0} \overline{0}$																														
$\overline{F} \overline{B} \overline{0} \overline{6}$	Master/slave setting for Inverter-to-inverter communications (common to 2-wire RS485)	$\overline{0}$:Slave (issues a 0Hz command if something goes wrong with the master) $\overline{1}$:Slave (continues operation if something goes wrong with the master) $\overline{2}$:Slave (trips for emergency stop if something goes wrong with the master) $\overline{3}$:Master (sends a frequency command) $\overline{4}$:Master (sends an output frequency) $\overline{5}$: - $\overline{6}$: -	$\overline{0}$																														
$\overline{F} \overline{B} \overline{0} \overline{7}$	Protocol selection (2-wire RS485)	$\overline{0}$:TOSHIBA, $\overline{1}$:MODBUS	$\overline{0}$																														



Title	Function	Adjustment range	Default setting
F810	Frequency point selection	0:Disabled 1:2-wire RS485 2:4-wire RS485 3:Communication add option	0
F811	Point 1 setting	0~100%	0
F812	Point 1 frequency	0.0~FH Hz	0.0
F813	Point 2 setting	0~100%	100
F814	Point 2 frequency	0.0~FH Hz	Inverter with a model number ending with -WN: 50.0 -WP: 50.0
F870	Block write data 1	0:Disabled 1:Command information 1 2:Command information 2 3:Frequency command 4:Terminal board output data 5:Communication analog output 6:Rotational speed command	0
F871	Block write data 2	Ditto	0
F875	Block read data 1	0:Deselect 1:Status information 2:Output frequency 3:Output current 4:Output voltage 5:Alarm information 6:PID feedback value 7:Input terminal board monitor 8:Output terminal board monitor 9:VI/II terminal board monitor 10:RR/S4 terminal board monitor 11:RX terminal board monitor 12:Input voltage (DC detection) 13:Speed feedback frequency 14:Torque 15:MY monitor 1 16:MY monitor 2 17:MY monitor 3 18:MY monitor 4 19:Free notes 20:Rotational speed	0
F876	Block read data 2	Ditto	0
F877	Block read data 3	Ditto	0
F878	Block read data 4	Ditto	0
F879	Block read data 5	Ditto	0
F880	Free notes	0~FFFF	0

*: No action No action is taken even if a timeout occurs.

Alarm An alarm goes off if a timeout occurs.

The message "L" blinks at the left end of the operation panel.

Trip The inverter trips when a communication time-over occurs.

The message "E r r 5" blinks on the operation panel.

Note: Changes to the parameters F800, F801 and F805 do not take effect until the power is turned off and then on again.

2) 4-wire RS485

The 4-wire RS485 device included as standard equipment, allows you to connect the inverter to a higher-level system (host) and to set up a network for data communications between inverters. It makes it possible for the inverter to be linked to a computer and to carry out data communications with other inverters. The connector (RJ45) for the 4-wire RS485 device on the control circuit terminal block is used to connect to other inverters.

■ Transmission specifications

Item	Specifications
Interface	Compliant with RS485
Transmission path specification	Half-duplex type [Buss type (terminator resistor required at each end of system)]
Wiring type	Compatible with both 4-wire and 2-wire types
Transmission distance	Up to 500m (overall length of the cable)
Number of connectable units	Up to 32 units (including the host computer) Number of inverters that can be connected in a system: Up to 32 units
Synchronization scheme	Asynchronous
Transmission rate	Default: 19200 baud (parameter setting) Selectable from 9600/19200/38400 baud
Character transmission	ASCII mode : JIS X 0201 8-bit (ASCII) Binary code : Binary, 8-bit (fixed)
Stop bit length	Inverter receiving: 1 bit, Inverter sending: 2 bits
Error detection	Parity: Even, Odd, or None selectable by parameter setting; check sum method
Error correction	Not provided
Response monitoring	Not provided
Character transmission format	Reception: 11 bit, Sending: 12 bit (with parity)
Transmission waiting time setting	Possible
Others	Inverter's action at the occurrence of a communication timeout selectable from tripping/raising an alarm/doing nothing →When alarm is selected, "E" blinks at the left end of the operation panel When tripping is selected, "Err 5" is displayed on the operation panel

■ Example of the connection of inverters linked to a computer

<Independent communication>

Perform computer-inverter connection as follows to send operation frequency commands from the host computer to inverter No. 3:

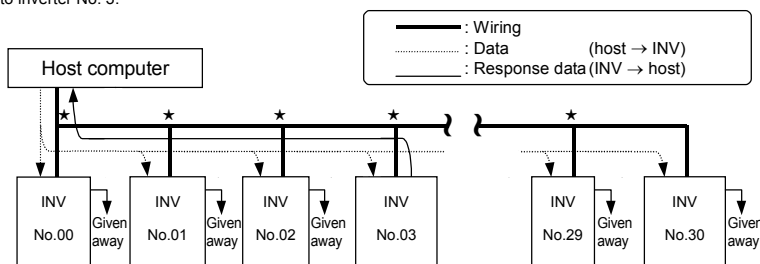

"Given away": Only the inverter with the selected inverter number conducts data processing. All other inverters, even if they have received the data, give it away and stand by to receive the next data.

★ : Use the terminal board to branch the cable.

- (1) Data is sent from the host computer.
- (2) Data from the computer is received at each inverter and the inverter numbers are checked.
- (3) The command is decoded and processed only by the inverter with the selected inverter number.
- (4) The selected inverter responds by sending the processing results, together with its own inverter number, to the host computer.
- (5) As a result, only the selected inverter starts operating in accordance with the operation frequency command by communicating independently.

<Broadcast>

When an operation frequency command is broadcasted from the host computer to inverters

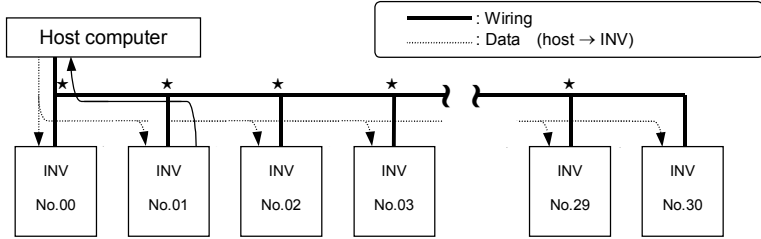

★: Use the terminal board to branch the cable.

- (1) Data is sent from the host computer.
- (2) Data from the computer is received at each inverter and the inverter numbers are checked.
- (3) Data with an asterisk (*) in the inverter number position is taken as broadcast data and the command is deciphered and executed.
- (4) To avoid collisions between data, only the inverter with the asterisk (*) replaced with a zero (0) returns data to the host computer.
- (5) As a result, all inverters connected are operated at the operation frequency specified by the command broadcasted.

Note: If an inverter number is assigned to each group of inverters, data can be broadcasted on a group-by-group basis.

(This function is usable only in ASCII mode. For binary mode, see Instruction Manual (E6581413) specified in Section 6.36.)

Ex.) When the inverter number *1 is specified, data is broadcasted to inverters Nos. 01, 11, 21, 31, ... 91. At that time, data is returned by the inverter bearing number 01.

■ Inverter-to-inverter communication

When all slave inverters are connected they operate at the same frequency as the master inverter (no setting of point frequencies in this case)

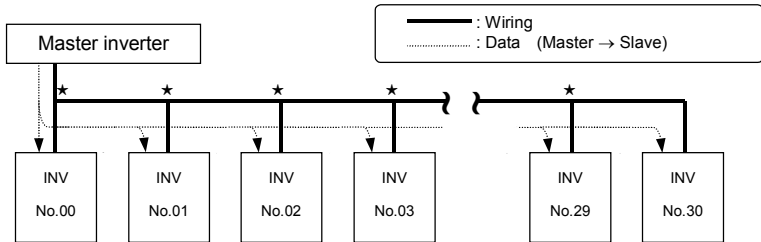

★: Use the terminal board to branch the cable.

- (1) The master inverter transmits frequency command data to its slave inverters.
- (2) The slave inverter calculate a frequency reference from the data received and save the frequency calculated.
- (3) As a result, all slave inverters operate at the same frequency as the master inverter.

Note: The master inverter always sends frequency command data to its slave inverters.

The slave inverters are always on standby so that they can receive a frequency command from the master inverter at anytime.

■ Setting for issuing run/stop commands from an external control device

Title	Function	Adjustment range	Default setting	Example of setting
$\text{C} \text{P} \text{Q} \text{d}$	Command mode selection	0~4	0 (Terminal input enabled)	3 (4-wire RS485)

Note: When parameter $\text{F} \text{B} \text{Z} \text{E}$ (setting for communications between inverters) is used, the setting $\text{C} \text{P} \text{Q} \text{d} = 3$ cannot be used for slave inverters.

■ Setting for issuing speed commands from an external control device

Title	Function	Adjustment range	Default setting	Example of setting
$\text{F} \text{P} \text{Q} \text{d}$	Frequency setting mode selection 1	1~12	2 (RR/S4 input)	6 (4-wire RS485)

■ Communication parameters (4-wire RS485)

These parameters allow you to change the communication speed, parity, inverter number, communication error trip timer setting, etc. from the operation panel or an external control device.

Title	Function	Adjustment range	Default setting		
F801	Parity (common to 2-wire RS485 and 4-wire RS485)	0:Non parity 1:Even parity 2:Odd parity	1		
F802	Inverter number (common)	0~247	0		
F803	Communications time-out time (common to 2-wire RS485 and 4-wire RS485)	0:OFF 1~100 sec.	0		
F804	Communications time-out action * (common to 2-wire RS485 and 4-wire RS485)	Setting	2-wire RS485	4-wire RS485	0
		0	No action	No action	
		1	Alarm	No action	
		2	Trip	No action	
		3	No action	Alarm	
		4	Alarm	Alarm	
		5	Trip	Alarm	
		6	No action	Trip	
7	Alarm	Trip			
8	Trip	Trip			
F810	Frequency point selection	0:Disabled 1:2-wire RS485 2:4-wire RS485 3:Communication add option	0		
F811	Point 1 setting	0~100 %	0		
F812	Point 1 frequency	0.0~FH Hz	0.0		
F813	Point 2 setting	0~100 %	100		
F814	Point 2 frequency	0.0~FH Hz	Inverter with a model number ending with -WN: 60.0 -WP: 50.0		
F820	Communication speed (4-wire RS485)	0:9600 bps, 1:19200 bps, 2:38400 bps	1		
F825	Send waiting time (4-wire RS485)	0.00:Default, 0.01~2.00 sec.	0.00		
F826	Inverter-to-inverter communication setting (4-wire RS485)	0:Slave (issues a 0Hz command if something goes wrong with the master) 1:Slave (continues operation if something goes wrong with the master) 2:Slave (trips for emergency stop if something goes wrong with the master) 3:Master (sends a frequency command) 4:Master (sends an output frequency) 5:- 6:-	0		
F829	Protocol selection (4-wire RS485)	0:TOSHIBA 1:MODBUS	0		
F870	Block write data 1	0:Disabled 1:Command information 1 2:Command information 2 3:Frequency command 4:Terminal board output data 5:Communication analog output 6:Rotational speed command	0		
F871	Block write data 2	Ditto	0		

Title	Function	Adjustment range	Default setting
<i>F875</i>	Block read data 1	<i>0</i> :Deselect <i>1</i> :Status information <i>2</i> :Output frequency <i>3</i> :Output current <i>4</i> :Output voltage <i>5</i> :Alarm information <i>6</i> :PID feedback value <i>7</i> :Input terminal board monitor <i>8</i> :Output terminal board monitor <i>9</i> :V/II terminal board monitor <i>10</i> :RR/S4 terminal board monitor <i>11</i> :RX terminal board monitor <i>12</i> :Input voltage (DC detection) <i>13</i> :Speed feedback frequency <i>14</i> :Torque <i>15</i> :MY monitor 1 <i>16</i> :MY monitor 2 <i>17</i> :MY monitor 3 <i>18</i> :MY monitor 4 <i>19</i> :Free notes <i>20</i> :Rotational speed	<i>0</i>
<i>F876</i>	Block read data 2	Ditto	<i>0</i>
<i>F877</i>	Block read data 3	Ditto	<i>0</i>
<i>F878</i>	Block read data 4	Ditto	<i>0</i>
<i>F879</i>	Block read data 5	Ditto	<i>0</i>
<i>F880</i>	Free notes	<i>0</i> ~ <i>FFF</i>	<i>0</i>

*: No action No action is taken even if a timeout occurs.

Alarm An alarm goes off if a timeout occurs.

The message "L" blinks at the left end of the operation panel.

Tripp The inverter trips when a communication time-over occurs.

The message "E r r 5" blinks on the operation panel.

Note: Changes to the parameters *F801*, *F820* and *F826* do not take effect until the power is turned off and then on again.

6.34.2 Open network option

<i>F830</i> ~ <i>F836</i>	: Communication option settings 1 to 7
<i>F841</i> ~ <i>F846</i>	: Communication option settings 8 to 13
<i>F850</i>	: Disconnection detection extended time
<i>F851</i>	: Inverter operation at disconnection
<i>F852</i>	: Preset speed operation selection
<i>F853</i> , <i>F854</i>	: Selection of monitoring
<i>F856</i>	: Number of motor poles for communication

⇒ For details, refer to Instruction Manual (E6581281, E6581343) specified in Section 6.36.

6.35 My function

F900: Input function target 11 ~ *F977*: My function selection

⇒ For details, refer to Instruction Manual (E6581335) specified in Section 6.36.

6.36 Instruction manuals for optionally available devices and special functions

For details, refer to the instruction manual for each optional device or function.

No.	Description	Model number	Instruction Manual No.	Remarks
1	PID control operation function	–	E6581329	
2	Speed control gain adjustment method	–	E6581333	
3	My function	–	E6581335	
4	Switching between commercial power and inverter	–	E6581364	
5	PS1 serial communication function	–	E6581413	
6	Combination of the VFPS1 and a DC power supply	–	E6581432	
7	Expansion I/O card 1 option	ETB003Z	E6581339	Attached to expansion I/O card 1 option
8	Expansion I/O card 2 option	ETB004Z	E6581341	Attached to expansion I/O card 2 option
9	PG feedback option	VEC004Z~ VEC007Z	E6581319	Attached to PG feedback option
10	DeviceNet option	DEV002Z	E6581295	Attached to DeviceNet option
11	DeviceNet option function	DEV002Z	E6581281	Detailed instruction manual
12	PROFIBUS-DP option	PDP002Z	E6581279	Attached to PROFIBUS –DP option
13	PROFIBUS-DP option function	PDP002Z	E6581343	Detailed instruction manual
14	CC-Link option	CCL001Z	E6581286	Attached to CC-Link option
15	CC-Link option function	CCL001Z	E6581288	Detailed instruction manual
16	LCD Remote Keypad	RKP004Z	E6581323	Attached to LCD Remote Keypad
17	LED Remote Keypad	RKP002Z	E6581277	Attached to LED Remote Keypad
18	Control power supply backup option	CPS002Z	E6581289	Attached to control power supply backup option
19	USB-to-Serial conversion unit	USB001Z	E6581282	Attached to USB-to-Serial conversion unit
20	USB-to-Serial conversion unit	USB001Z	E6581299	Attached in the storage device of USB-to-Serial conversion unit
21	Optional braking unit PB7	PB7-4200K PB7-4400K	E6581436	For 250kW or more units
22	Fin outside mounting kit (optional)	FOT***Z	E6581399 E6581400 E6581365	200V-15kW, 400V-18.5kW 200V-18.5~45kW, 400V-22~75kW 200V-55kW~, 400V-90kW~

7. Operation with external signal

7.1 External operation

The inverter can be freely controlled externally.

Parameters must be differently set depending on the operation method. Make sure of the operation method before setting parameters, and set parameters properly to the operation mode according to the procedure mentioned below.

[Steps in setting parameters]

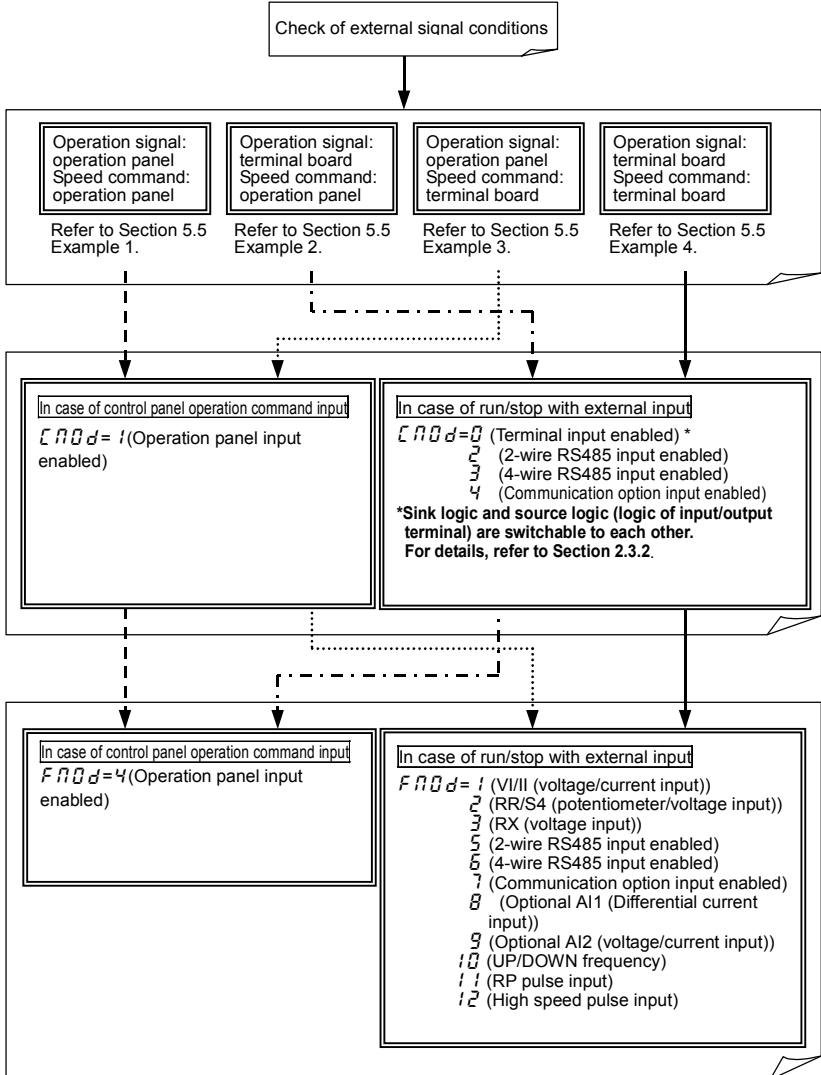

7.2 Applied operation with input and output signals (operation by terminal board)

7.2.1 Functions of input terminals (in case of sink logic)

Use the above parameters to send signals from an external programmable controller to various control input terminals to operate and/or set the inverter.

The desired contact input terminal functions can be selected from about 80 types. This gives system design flexibility.

[Control terminal board]

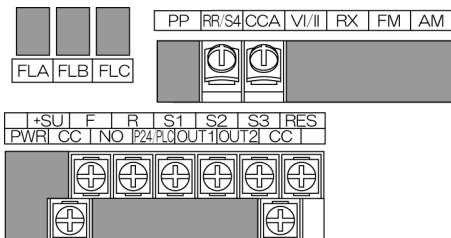

Setting of contact input terminal function

Terminal symbol	Title	Function	Adjustment range	Default setting
-	<i>F 110</i>	Always ON function selection 1	0~135 → Refer to Section 7.2.1.	5 (Standby)
-	<i>F 127, F 128</i>	Always ON function selection 2, 3		0 (No function is assigned)
F	<i>F 111</i>	Input terminal function selection 1 (F)		2 (Forward run)
R	<i>F 112</i>	Input terminal function selection 2 (R)		4 (Reverse run)
RES	<i>F 114</i>	Input terminal function selection 4 (RES)		8 (Reset)
S1	<i>F 115</i>	Input terminal function selection 5 (S1)		10 (Preset speed 1)
S2	<i>F 116</i>	Input terminal function selection 6 (S2)		12 (Preset speed 2)
S3	<i>F 117</i>	Input terminal function selection 7 (S3)		14 (Preset speed 3)
RR/S4	<i>F 118</i>	Input terminal function selection 8 (RR/S4)		16 (Preset speed 4)
LI1~LI8	<i>F 119~F 126</i>	Input terminal function selection 9~16		0

Note: When *F 110*, *F 127* and *F 128* (Always ON function selection 1~3) are selected, selected function is generally activated regardless of positive or negative logic.

Note: *F 119~F 126* is for use of expansion terminal board option unit.

Connection method

1) In case of positive logic (a-contact) input

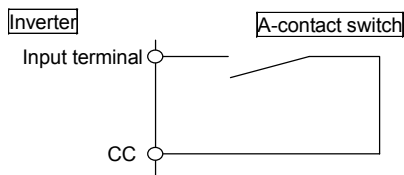

★ This function is activated when the input terminal and CC (common) are short-circuited. Use this function to specify forward/reverse run or a preset speed operation.

2) In case of negative logic (b-contact) input

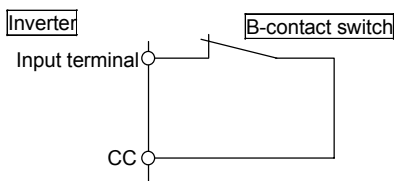

★ This function is activated when the input terminal and CC (common) are open-circuit. Use this function to specify operation standby signal or reset signal.

3) Connection with transistor output

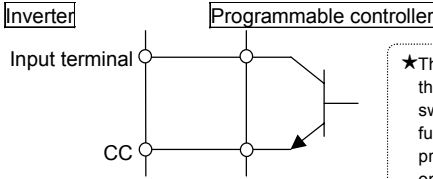

★The inverter can be controlled by connecting the input terminal with output (contactless switch) of a programmable controller. Use this function to specify forward/reverse run or a preset speed operation. Use a transistor that operates on 24Vdc, 5mA power.

* Interface between programmable controller and inverter

When using an open-collector output type programmable control device to control the operation of a motor, connect cables, as shown in the schematic diagram for sink/source logic (when an external power supply is used) on page B-15. When using the internal power supply of the inverter, connect cables, as shown in the schematic diagram on page B-14. If the programmable control device is turned off with the inverter left on, an incorrect signal will flow into the inverter, as shown in the figure below, because there is a potential difference between the control power supplies. Be sure to provide an interlock so that the programmable controller cannot be turned off when the inverter is on.

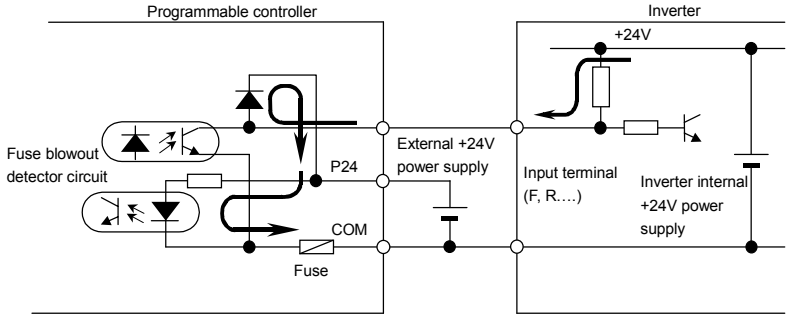

■ Example of use- three-wire operation

The three-wire operation function allows you to make the inverter self-hold its operation, without setting up a sequential circuit, so that the inverter can be operated by means of external signals (reset contact signals).

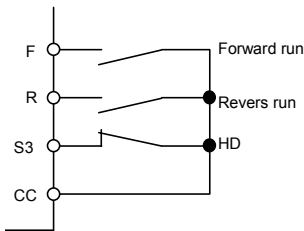

Forward run (F): If you press the Forward (F) button, the motor rotates in the forward direction at the frequency specified with a command.
 Revers run (R): If you press the Reverse (R) button, the motor rotates in the reverse direction at the frequency specified with a command.
 HD (S3): If you press the HD (S3) button, the motor decelerates and comes to a stop.

[Parameter setting]

Terminal symbol	Title	Function	Adjustment range	Example of setting
S3	F 117	Input terminal function selection 7(S3)	0~135	58 (HD operation retention)

■ Table of setting of contact input terminal function

Parameter setting		Function	Parameter setting		Function
Positive logic	Negative logic		Positive logic	Negative logic	
0	1	No function is assigned	76	77	Trace back trigger signal
2	3	F: Forward run command	80	81	No function assigned
4	5	R: Reverse run command	82	83	No function assigned
6	7	ST: Standby	84	85	No function assigned
8	9	RES: Reset	86	87	Binary data write
10	11	S1: Preset speed 1	88	89	Up/down frequency (up) *1
12	13	S2: Preset speed 2	90	91	Up/down frequency (down) *1
14	15	S3: Preset speed 3	92	93	Up/down frequency (clear)
16	17	S4: Preset speed 4	94	95	No function assigned
18	19	Jog run	96	97	No function assigned
20	21	Emergency stop	98	99	Forward/reverse selection
22	23	DC braking	100	101	Run/stop command *3
24	25	Acceleration/deceleration switching 1	102	103	Commercial power/INV switching
28	29	V/f switching signal 1	104	105	Frequency reference priority switching
36	37	PID control OFF selection	106	107	VI/II terminal priority
46	47	External thermal error	108	109	Command terminal board priority
48	49	Communication priority cancel	110	111	Permission of parameter editing
50	51	HD operation retention	114	115	No function assigned
52	53	PID differentiation/integration clear	116	117	No function assigned
54	55	PID forward/reverse switching	118	119	No function assigned
56	57	Forced continuous operation	120	121	No function assigned
58	59	Specified speed operation	122	123	Rapidest deceleration command
64	65	My function RUN signal	124	125	Preliminary excitation *4
66	67	Auto-tuning signal	128	129	No function assigned
74	75	Integrating wattmeter display clear	132	133	No function assigned

*1: Valid when $F\bar{R}0d$ (Frequency setting mode selection 1) is set at 10 (Up/down frequency).

The frequency setting range is between $=0.0\sim UL$ (Upper limit frequency). The acceleration/deceleration time with respect to the frequency setting remains $R\bar{C}\bar{C}1dE\bar{C}$, unless switching between acceleration and deceleration is performed.

*2: If 2, 3 (F: Forward run command) or 4, 5 (R: Reverse run command) is assigned at the same time, this function has a priority.

*3: After the motor slows down and comes to a full stop at a pre-excitation command, the motor is set free momentarily to bring it into a pre-excitation state.

This function should not be used when $F\bar{C}05$ is set to 2 or 4. Or the inverter might malfunction.

*4: Do not specify any number other than those listed in this table.

■ Sink logic/source logic

Switching between sink logic and source logic (input/output terminal logic) is possible.

⇒ For details, refer to the Section 2.3.2.

7.2.2 Functions of output terminals (incase of sink logic)

Use the above parameters to send various signals from the inverter to external equipment.

By setting parameters for the OUT1, OUT2 and FL (FLA, FLB and FLC) terminals on the terminal board, you can use 0~255 functions and functions obtained by combining them.

[Control terminal board]

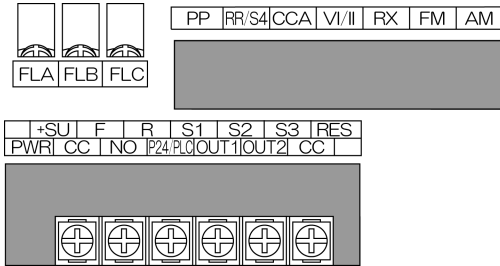

■ How to use

Function of OUT1.....To be set by parameter *F 130*

Function of OUT2.....To be set by parameter *F 131*

Functions of FLA, FLB, and FLC.....To be set by parameter *F 132*

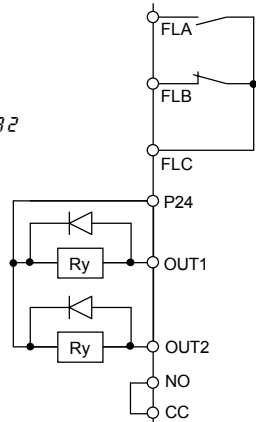

■ Setting of output terminal function

Terminal symbol	Title	Function	Adjustment range	Default setting
OUT1	<i>F 130</i>	Output terminal function selection 1	0~255	4 (Low-speed signal)
OUT2	<i>F 131</i>	Output terminal function selection 2	0~255	5 (Acceleration/deceleration completion)
FL	<i>F 132</i>	Output terminal selection 3	0~255	10 (Failure FL)
OUT3~OUT6 R1~R2	<i>F 133~F 138</i>	Output terminal function selection 4~9	0~255	254
R3, R4	<i>F 158, F 159</i>	Output terminal function selection 10~11	0~255	254

Note: *F 133~F 135* is for use of expansion terminal board 1 option unit.

Note: *F 136~F 138* is for use of expansion terminal board 2 option unit.

Note: *F 158, F 159* is for use of 16 bit binary board option unit.

■ Output terminal function (open collector, relay outputs) setting and detection levels

For the open connector output terminals (OUT1, OUT2) and the relay output terminals (FLA, FLB and FLC), functions can be selected from 0 to 255 functions. The selectable functions and detection levels are listed in the table below.

Up to 7 output terminals can be used if add-on options are used in combination with the inverter, while up to 3 output terminals can be used if no add-on option is used.

<Technical terms>	
• AlarmAlarm output beyond a certain setting value.
• Pre-alarmAlarm output of the state where the inverter may carry out a trip by continuation.
• Serious failureOutput signal in a serious failure of the protection function of the inverter. (Arm overcurrent (OL1, OL2, OL3), Load side overcurrent (OLC), Short-circuiting (EF1, EF2), Phase failure (EPH0, EPH1), Abnormal output current detection (Err1))
• Light failureOutput signal in a slight failure of the protection function of the inverter. (Overload (OL1, OL2), overvoltage (OP1, OL3), overcurrent during acceleration/deceleration/fix speed operation (OC1, OP2, OP3, OP3))
• Emergency stopOutput signal when the inverter comes into emergency stop. Stopping manner is set with F503 (emergency stop).

Table of output terminal functions and detection levels

Parameter setting		Function	Operation output specifications (in case of positive logic)
Positive logic	Negative logic		
0	1	Lower limit frequency (LL)	ON:The running frequency is equal to or higher than the setting of LL (Lower limit frequency) OFF:The running frequency is lower than the setting of LL.
2	3	Upper limit frequency (UL)	ON:The running frequency is equal to or higher than the setting of UL (Upper limit frequency) OFF:The running frequency is lower than the setting of UL.
4	5	Low-speed signal	ON:The running frequency is equal to or higher than the setting of F00 (low-speed signal output frequency) OFF:The running frequency is lower than the setting of F100.
6	7	Acceleration/deceleration completion	ON:The difference between the frequency command and the running frequency is within the setting of F102. OFF:In acceleration or deceleration.
8	9	Speed reach signal	ON:The running frequency is in the range of F101 ± F102. OFF:The running frequency is out of the range of F101 ± F102.
10	11	Failure FL (All trips)	ON:Inverter is tripped. OFF:Inverter trip is canceled.
12	13	Failure FL (Except EF, OCL)	ON:Inverter is tripped (except EF and OCL) OFF:Inverter trip is canceled. (reset)
14	15	Overcurrent (OC) pre-alarm	ON:Inverter output current is over the F501 (Stall prevention level) set value. OFF:Inverter output current is under the F501.
16	17	Inverter overload (OL1) pre-alarm	ON:A certain rate of inverter overload (OL1) detection time is over. OFF:The detection time is within a certain limit.
18	19	Motor overload (OL2) pre-alarm	ON:A certain rate of inverter overload (OL2) detection time is over. OFF:The detection time is within a certain limit.
20	21	Overheat pre-alarm	ON:The temperature of the cooling fin is 95°C or higher inside the inverter. OFF:The temperature drops to 90°C or lower after overheat pre-alarm was on.
22	23	Overvoltage pre-alarm	Overvoltage control operation or PB operation in progress. ON: PB operation level + 3% (200V class: Approx. 370Vdc, 400V class :Approx. 740Vdc)
24	25	Undervoltage in main circuit (MOFF) detection	ON:The main circuit voltage is lower than the main circuit undervoltage detection (MOFF) level. (200V class: Approx. 170Vdc, 400V class: Approx. 340Vdc)
26	27	Low current detection	ON: The state that inverter output current is F511 set value or larger continued more than F512 set value.

Parameter setting		Function	Operation output specifications (in case of positive logic)
Positive logic	Negative logic		
28	29	Over-torque detection	ON:The state that torque component is $F616$, $F617$ set value or larger continued more than $F618$ set value.
30	31	Braking resistor overload pre-alarm	ON:A certain rate of braking resistor overload trip ($D1r$) detection time is over. OFF:The detection time is within a certain limit.
32	33	In emergency stop	ON:In emergency stop operation (E is indicated). OFF:The detection time is within a certain limit.
34	35	In retry	ON:In retry operation ($rErY$ is indicated). OFF:No retry operation is performed.
38	39	PID deviation limit	ON:PID deviation is in $F364$ or $F365$ set value.
40	41	Run/Stop	ON:Running frequency is output or DC injection breaking (db) is performed.
42	43	Serious failure (OCA, OCL, EF, phase failure, etc.)	ON:Serious failure (OCA , OCL , EF , phase failure, abnormal output, short-circuit) is detected. OFF:Inverter has recovered from serious failure. (Serious failure has been reset)
44	45	Light failure (OL, OC1, 2, 3, OP)	ON:Light failure (OL , $OC1$, $OC2$, $OC3$, OP) is detected. OFF:Inverter has recovered from light failure. (Light failure has been reset)
46	47	Commercial power/inverter switching output 1	Refer to Section 6.17.
48	49	Commercial power/inverter switching output 2	Refer to Section 6.17.
50	51	Cooling fan ON/OFF	ON:Cooling fan is in operation. OFF:Cooling fan is off operation.
52	53	In jogging operation (In jog run)	ON:In jog run OFF:In normal operation
54	55	Operation panel/terminal board operation switching	ON:In operation by terminal board. OFF:In operation by operation panel.
56	57	Cumulative operation time alarm	ON:Cumulative operation time is beyond the $F621$ set value. OFF:Cumulative operation time is less than the $F621$ set value.
58	59	PROFIBUS/DeviceNet/CC-Link communication error	ON:Communication error occurred. OFF:Communication error is canceled (reset).
60	61	Forward/reverse switching	OFF:In forward operation. ON:In reverse operation. (The last status is held while operation is suspended.)
62	63	Ready for operation 1	ON:In operable status or operation can be started with frequency command input as an operation switching answer-back. OFF:In inoperable status.
64	65	Ready for operation 2	ON:In operable status or operation can be started with RUN signal and frequency command input. OFF:In inoperable status.
70	71	In (pre-)alarm status	ON:More than one of alarm, pre-alarm, undervoltage, low current over-torque, poor control power supply, PID deviation limit, abnormal frequency setting or torque limit have occurred or detected. OFF:All the alarms above are canceled.
76	77	Inverter healthy output	ON and OFF are alternately output at intervals of 1 second.
78	79	RS485 communication error	ON:Communication error occurred. OFF:Communication error is canceled (reset).
80	81	Error code output 1	Output the error code in 6-bit.
82	83	Error code output 2	
84	85	Error code output 3	
86	87	Error code output 4	
88	89	Error code output 5	
90	91	Error code output 6	
92	93	Specified data output 1	Output of the designated data in 7-bit.
94	95	Specified data output 2	
96	97	Specified data output 3	

Parameter setting		Function	Operation output specifications (in case of positive logic)
Positive logic	Negative logic		
98	99	Specified data output 4	Output of the designated data in 7-bit.
100	101	Specified data output 5	
102	103	Specified data output 6	
104	105	Specified data output 7	
110	111	Positive torque limit	ON:Positive torque is over the positive torque limit level.
112	113	Negative torque limit	ON:Negative torque is over the positive torque limit level.
114	115	Output for external rush suppression relay	ON:External rush suppression relay is actuated.
120	121	L-STOP	ON:Operation at the lower limit frequency is performed continuously.
128	129	Part replacement alarm	Alarm:The time of replacement of parts is approaching.
130	131	Over-torque pre-alarm	ON:Over-torque is detected.
132	133	Frequency command 1/2 selection	ON:Frequency command selection 2 is selected.
134	135	Failure FL (Except emergency stop)	ON:A trip other than emergency stop has occurred.
136	137	Local/remote switching	ON: Local mode
138	139	Forced operation (Force)	ON: Forced operation (Operation continued in the case of a minor failure)
140	141	Forced operation (Force)	ON: Forced operation
142	143	Undertorque detection	ON: If an undertorque is detected
144	145	Frequency command agreement signal (RR/S4)	ON: If the frequency command specified with $F\cancel{R}0d$ or $F\cancel{R}207$ agrees with the frequency command entered via RR/S4 (when RR is used as a signal input terminal). An agreement range can be specified with $F\cancel{R}374$.
146	147	Frequency command agreement signal (VI)	ON: If the frequency command specified with $F\cancel{R}0d$ or $F\cancel{R}207$ agrees with the frequency command entered via VI. An agreement detection range can be specified with $F\cancel{R}374$.
148	149	Frequency command agreement signal (RX)	ON: If the frequency command specified with $F\cancel{R}0d$ or $F\cancel{R}207$ agrees with the frequency command entered via RX. An agreement detection range can be specified with $F\cancel{R}374$.
150	151	PTC alarm detection	ON: If the PTC thermal specified with $F\cancel{B}45$ or $F\cancel{B}46$ is detected
152	153	Power removal signal	ON: When a PWR input signal is received
154	155	VI/VII input wire breakage	ON: If the breakage of a VI/VII input wire is detected
222	223	My function output 1	ON:My function output 1 is ON.
224	225	My function output 2	ON:My function output 2 is ON.
226	227	My function output 3	ON:My function output 3 is ON.
228	229	My function output 4	ON:My function output 4 is ON.
230	231	My function output 5	ON:My function output 5 is ON.
232	233	My function output 6	ON:My function output 6 is ON.
234	235	My function output 7	ON:My function output 7 is ON.
236	237	My function output 8	ON:My function output 8 is ON.
238	239	My function output 9	ON:My function output 9 is ON.
240	241	My function output 10	ON:My function output 10 is ON.
242	243	My function output 11	ON:My function output 11 is ON.
244	245	My function output 12	ON:My function output 12 is ON.
246	247	My function output 13	ON:My function output 13 is ON.
248	249	My function output 14	ON:My function output 14 is ON.
250	251	My function output 15	ON:My function output 15 is ON.
252	253	My function output 16	ON:My function output 16 is ON.
254	255	Always OFF (for terminal signal tests)	Output signal always OFF

Note 1: "ON" in positive logic : Open collector output transistor or relay is turned on.

"OFF" in positive logic : Open collector output transistor or relay is turned off.

"ON" in negative logic : Open collector output transistor or relay is turned off.

"OFF" in negative logic : Open collector output transistor or relay is turned on.

Note 2: Alarm output check conditions are as follows.

- (1) Undervoltage detected :To be checked during operation.
- (2) Low current detected : To be checked during operation command.
- (3) Overtorque detected : To be checked always.

■ Sink logic/source logic

Sink logic and source logic (logic of input/output terminal) can be switched to each other.

⇒ For details, refer to Section 2.3.2.

7.2.3 Analog input filter

•Function

This function is effective to remove noise from the frequency setting circuit. If operation is unstable because of noise, increase the time constant of the analog input filter.

■ Response time setting

Title	Function	Adjustment range	Default setting
<i>F209</i>	Analog input filter	<i>0</i> :No filter <i>1</i> :Filter approx. 10ms <i>2</i> :Filter approx. 15ms <i>3</i> :Filter approx. 30ms <i>4</i> :Filter approx. 60ms	<i>0</i>

7.3 Setup of external speed command (analog signal)

Function of analog input terminals can be selected from four functions (external potentiometer, 0 to 10Vdc, 0 (0) to 20mAdc, -10 to +10Vdc). The selective function of analog input terminals gives system design flexibility.
 ⇒ Refer to Section 6.28 for fine adjustment of analog setting signal and output frequency.

[Control terminal board]

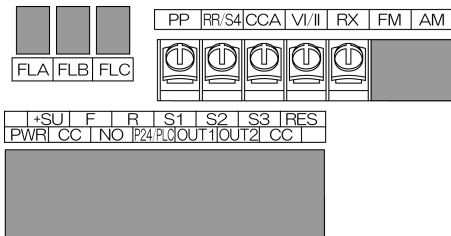

■ Setting of analog input terminal functions

Terminal symbol	Title	Function	Adjustment range	Default setting
-	F200	Frequency priority selection	0:F00d/F207 terminal switching (input terminal function selection 104, 105) 1:F00d/F207 frequency switching (switch by F208)	0
VI/II	F201	VI/II input point 1 setting	0~100%	0
	F202	VI/II input point 1 frequency	0.0~FH Hz	0.0
	F203	VI/II input point 2 setting	0~100%	100
-	R1F2	VI/II input point 2 frequency	0.0~FH Hz	*1
-	F207	Frequency setting mode selection 2	Same as F00d (1~12)	1
-	F208	Speed command priority switching frequency	0.1~FH	0.1
All	F209	Analog input filter	0 (No filter)~3 (Max. filter)	0
RR/S4	F210	RR/S4 input point 1 setting	0~100%	0
	F211	RR/S4 input point 1 frequency	0.0~FH Hz	0.0
	F212	RR/S4 input point 2 setting	0~100%	100
	R1F2	RR/S4 input point 2 frequency	0.0~FH Hz	*1
RX	F216	RX input point 1 setting	-100~100%	0
	F217	RX input point 1 frequency	0.0~FH Hz	0.0
	F218	RX input point 2 setting	-100~100%	100
	F219	RX input point 2 frequency	0.0~FH Hz	*1
Option	F222 ~F231	A11, A12 input point setting	For details, see Instruction Manual (E6581341) specified in Section 6.36.	
	F234 ~F237	RP/high speed pulse input point setting	For details, see Instruction Manual (E6581319) specified in Section 6.36.	

*1: Inverter with a model number ending with -WN: 60.0 -WP: 50.0

Note 1: Input terminals of A11 and A12 are at expansion TB option unit.

Note 2: Input terminals of RP/high speed pulse is at PG feedback device option unit.

7.3.1 Setup by analog input signals (RR/S4 terminal)

If a potentiometer (1~10kΩ-1/4W) for setting up frequency is connected with the RR/S4 terminal, the inverter can be run and stopped with external commands.

For bringing this function into practice, connect a potentiometer to the terminals of PP, RR/S4 and CC so as to divide the reference voltage (10Vdc) at the terminal PP and to input 0 to 10Vdc of divided voltage between the RR/S4 and CC terminals.

If analog voltage signal of 0 to 10Vdc is input between the terminals of RR/S4 and CC, frequency can be set up without connection of a potentiometer.

Title	Function	Adjustment range	Default setting	Example of setting
<i>C n d</i>	Command mode selection	0~4	0 (Terminal)	0 (Terminal)
<i>F n d</i>	Frequency setting mode selection 1	1~12	2 (RR/S4)	2 (RR/S4)
<i>F n 5 L</i>	FM terminal meter selection	0~64	0	1
<i>F n</i>	FM terminal meter adjustment	-	-	-
<i>F 2 0 0</i>	Frequency priority selection	0, 1	0	0
<i>F 2 0 9</i>	Analog input filter	0 (No filter)~3 (Max. filter)	0	0
<i>F 2 1 0</i>	RR/S4 input point 1 setting	0~100 %	0	0
<i>F 2 1 1</i>	RR/S4 input point 1 frequency	0.0~FH Hz	0.0	0.0
<i>F 2 1 2</i>	RR/S4 input point 2 setting	0~100 %	100	100
<i>R u F 2</i>	RR/S4 input point 2 frequency	0.0~FH Hz	*1	*1

*1: Inverter with a model number ending with -WN: 60.0 -WP: 50.0

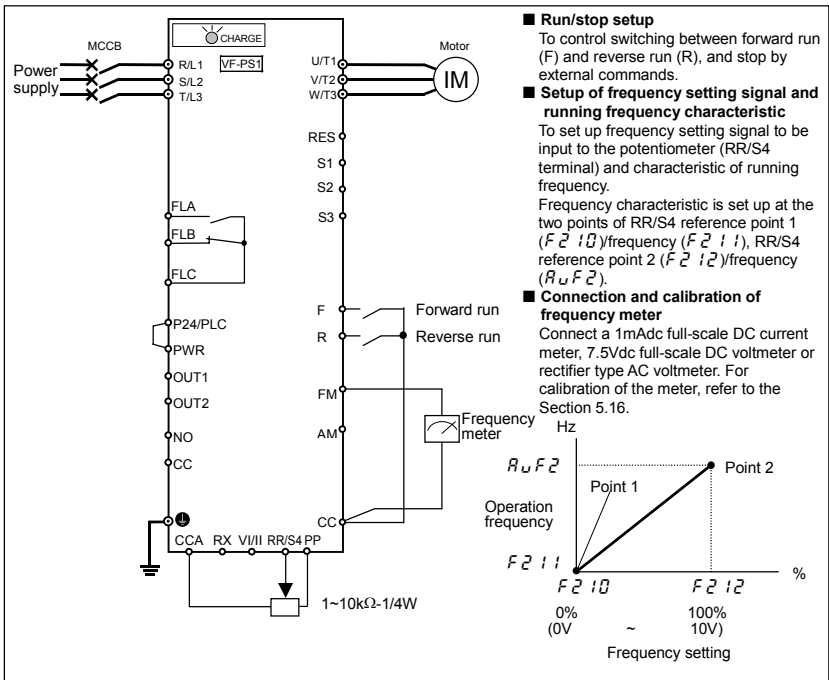

7.3.2 Setup by analog input signals (V/II terminal)

Connect current signal (4 (0) to 20mAcd) or voltage signal (0 to 10Vdc) to the terminal II so that the inverter can be run and stopped with external commands.

Title	Function	Adjustment range	Default setting	Example of setting	
				4 (0)~20mAcd	0~10Vdc
<i>C n d</i>	Command mode selection	0~4	0 (Terminal)	0 (Terminal)	0 (Terminal)
<i>F n d</i>	Frequency setting mode selection 1	1~12	2 (RR/S4)	1 (V/II)	1 (V/II)
<i>F n S L</i>	FM terminal meter selection	0~64	0	1	1
<i>F n</i>	FM terminal meter adjustment	-	-	-	-
<i>F 1 0 0</i>	Analog V/II voltage/current switching	0: Voltage input 1: Current input	0	1	1
<i>F 2 0 0</i>	Frequency priority selection	0, 1	0	0	0
<i>F 2 0 1</i>	V/II input point 1 setting	0~100 %	0	20.0	0.0
<i>F 2 0 2</i>	V/II input point 1 frequency	0.0~FH Hz	0.0	0.0	0.0
<i>F 2 0 3</i>	V/II input point 2 setting	0~100 %	100	100	100
<i>R 1 F 2</i>	V/II input point 2 frequency	0.0~FH Hz	*1	*1	*1
<i>F 2 0 9</i>	Analog input filter	0 (No filter)~3 (Max. filter)	0	0	0

*1: Inverter with a model number ending with -WN: 60.0 -WP: 50.0

■ Run/stop setup
To control switching between forward run (F) and reverse run (R), run and stop by external commands.

■ Setup of frequency setting signal and running frequency characteristic
To set up frequency setting signal to be input to the external signal (V/II terminal) and characteristic of running frequency. Frequency characteristic is set up at the two points of V/II reference point 1 (*F 2 0 1*)/frequency (*F 2 0 2*), V/II reference point 2 (*F 2 0 3*)/frequency (*R 1 F 2*).

■ Connection and calibration of frequency meter
Connect a 1mAcd full-scale DC current meter, 7.5Vdc full-scale DC voltmeter or rectifier type AC voltmeter. For calibration of the meter, refer to the Section 5.16.

*4(0)~20mAcd or 0~10Vdc

★To apply a current through the V/II terminal, the setting of *F 1 0 0* needs to be changed.

7.3.3 Setup by analog input signals (RX terminal)

Connect voltage signal (0 to ±10Vdc) to the terminal RX so that the inverter can be run and stopped with external commands.

Title	Function	Adjustment range	Default setting	Example of setting
<i>C n d</i>	Command mode selection	0~4	0 (Terminal)	0 (Terminal)
<i>F n d</i>	Frequency setting mode selection 1	1~12	2 (RR/S4)	3 (RX)
<i>F n S L</i>	FM terminal meter selection	0~64	0	1
<i>F n</i>	FM terminal meter adjustment	-	-	-
<i>F 2 0 0</i>	Frequency priority selection	0, 1	0	0
<i>F 2 0 9</i>	Analog input filter	0 (No filter)~3 (Max. filter)	0	0
<i>F 2 1 6</i>	RX input point 1 setting	-100~100 %	0	0
<i>F 2 1 7</i>	RX input point 1 frequency	0.0~FH Hz	0.0	0.0
<i>F 2 1 8</i>	RX input point 2 setting	-100~100 %	100	100
<i>F 2 1 9</i>	RX input point 2 frequency	0.0~FH Hz	*1	*1

*1: Inverter with a model number ending with -WN: 60.0 -WP: 50.0

- **Run/stop setup**
Run/stop operation by means of external commands.
- **Setup of frequency setting signal and running frequency characteristic**
To set up frequency setting signal to be input to the external signal (RX terminal) and characteristic of running frequency. Frequency characteristic is set up at the two points of RX reference point 1 (*F 2 1 6*)/frequency (*F 2 1 7*), RX reference point 2 (*F 2 1 8*)/frequency (*F 2 1 9*).
- **Connection and calibration of frequency meter**
Connect a 1mAdc full-scale DC current meter, 7.5Vdc full-scale DC voltmeter or rectifier type AC voltmeter. For calibration of the meter, refer to the Section 5.16.

*: Regardless of open/closed circuit between R and CC terminals, run and stop operation is controllable.
Switching between forward run and reverse run is controllable by the terminals F/R and RX if reverse run prohibition selection *F 3 1 1* is properly set up.
⇒ For details, refer to Section 6.15.4.

8. Monitoring the operation status

8.1 Screen composition in the status monitor mode

The status monitor mode is used to monitor the operation status of the inverter.

⇒ For modes available and instructions about how to switch them, refer to section 3.1.

Here is the screen composition in the status monitor mode.

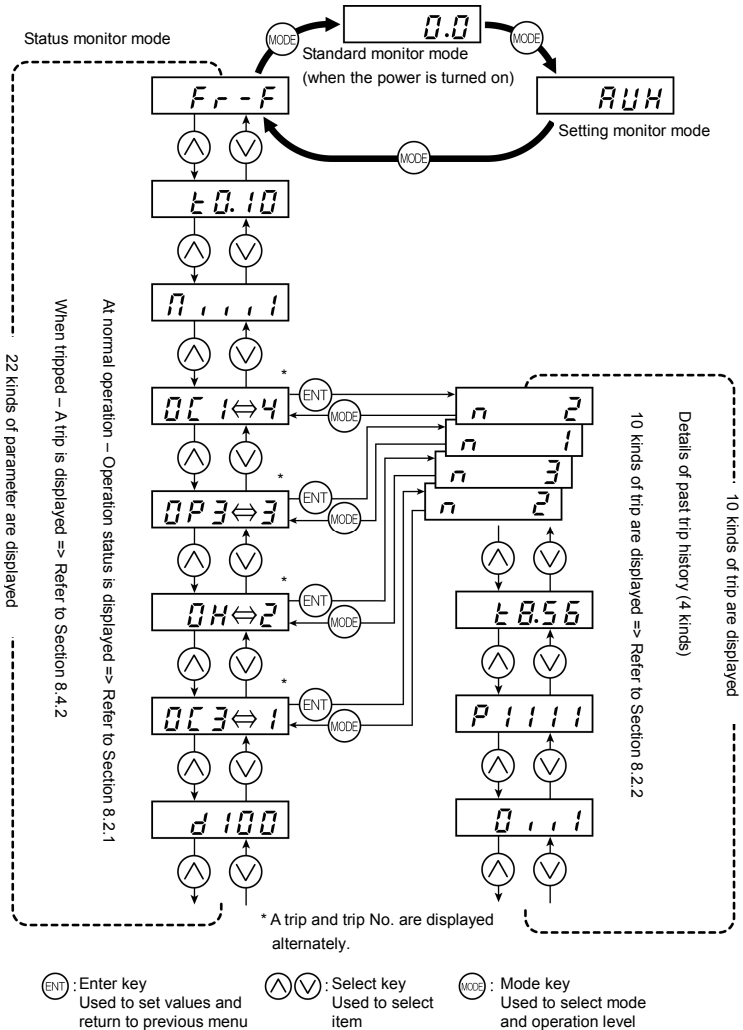

8.2 Monitoring the status

8.2.1 Status monitor under normal conditions

In this mode, you can monitor the operation status of the inverter.

To monitor the inverter when it is normally running, press the **(MODE)** key **twice** and the current status is indicated on the LED display.

Setting procedure (EX.: operation at 60 Hz)

Communication No.	Item displayed	Key operated	LED display	Description
*1	-		60.0	The operation frequency is displayed (during operation). (When standard monitor display selection F 7 1 0 is set to 0 [Output frequency])
	FE01	(MODE)	RUH	The first basic parameter "History function (RUH)" is displayed.
	FE01	(MODE)	F r - F	The rotating direction is displayed. (F:Forward run, r:Reverse run)
*2	-	(▲)	60.0	The operation frequency command value is displayed. (When F 7 1 1 = 1, Frequency command)
*3	-	(▲)	ε 80	The inverter output current (load current) is displayed. (When F 7 1 2 = 2, Output current)
*4	-	(▲)	Y 100	The inverter DC voltage (default setting: unit %) is displayed. (When F 7 1 3 = 3, Input voltage) [Note 3]
*5	-	(▲)	P 100	The inverter output voltage (default setting: unit %) is displayed. (When F 7 1 4 = 4, output voltage)
	FE06	(▲)		The ON/OFF status of each of the control signal input terminals (F, R, RES, S1, S2, S3, RR/S4) is displayed in bits.
		(▲)	R	The ON/OFF status of each of the optional control signal input terminals (LI1, LI2, LI3, LI4) is displayed in bits.
		(▲)	b	The ON/OFF status of each of the optional control signal input terminals (LI5, LI6, LI7, LI8) is displayed in bits.
[Note 4]	FE07	(▲)	0	The ON/OFF status of each of the control signal output terminals (OUT1, OUT2, FL) is displayed in bits.
		(▲)		The ON/OFF status of each of the optional control signal output terminals (OUT3, OUT4, R1, OUT5, OUT6, R2, R3, R4) is displayed in bits.
	FE08	(▲)	u 100	The version of the CPU1 is displayed.
	FE73	(▲)	c 100	The version of the CPU2 is displayed.
[Note 5]	FE10	(▲)	0C3⇔1	Past trip 1 (displayed alternately at 0.5-sec. intervals)
[Note 5]	FE11	(▲)	0H ⇔2	Past trip 2 (displayed alternately at 0.5-sec. intervals)
[Note 5]	FE12	(▲)	0P3⇔3	Past trip 3 (displayed alternately at 0.5-sec. intervals)
[Note 5]	FE13	(▲)	nErr⇔4	Past trip 4 (displayed alternately at 0.5-sec. intervals)

(Continued overleaf)

(Continued)

Communication No.	Item displayed	Key operated	LED display	Description
[Note 6] FE79	Part replacement alarm information		$\bar{n} \dots \bar{i}$	The ON/OFF status of each of the cooling fan, circuit board capacitor, main circuit capacitor or part replacement alarm of cumulative operation time is displayed in bits. ON: \bar{i} OFF: \bar{n} Cooling fan Control circuit board capacitor Main circuit capacitor
[Note 7] FE14	Cumulative operation time		$\bar{t} \bar{0} \bar{.} \bar{i} \bar{0}$	The cumulative operation time is displayed. (Indication of 0.1 represents 10 hours.)
	Default display mode	 [Note 1]	$\bar{0} \bar{0} \bar{0}$	The operation frequency is displayed (during operation).

Note 1: Press the keys to change items displayed in the status monitor mode.

Note 2: Contents of status indications of *1, *2, *3, *4, and *5 can be selected from about 40 kinds of information. Contents of status indications that are set up at $F \bar{7} \bar{i} \bar{0}$ (standard monitor display selection) and $F \bar{7} \bar{i} \sim F \bar{7} \bar{i} \bar{4}$ (status monitor 1 to 4 display selection) are displayed.

Unit of current and voltage indications can be changed from % to A (ampere)/V (volt) and vice versa respectively. ⇒ Refer to Section 5.15.

Note 3: Indicated input voltage is DC voltage just after input voltage is rectified multiplied by $1/\sqrt{2}$.

Note 4: The number of bars displayed varies depending on the setting of $F \bar{5} \bar{5} \bar{9}$ (logic output/pulse train output selection.)

The bar representing the OUT1 terminal is displayed only when logic output function is assigned to it.

If $F \bar{5} \bar{5} \bar{9} = \bar{0}$: The bar representing OUT1 is displayed.

If $F \bar{5} \bar{5} \bar{9} = \bar{1}$: The bar representing OUT1 is not displayed.

Note 5: Past trip records are displayed in the following sequence: 1 (latest trip record) ⇔ 2⇔3⇔4 (oldest trip record).

If there is no trip record, $\bar{n} \bar{E} \bar{r} \bar{r}$ is displayed.

Details on past trip record 1, 2, 3 or 4 can be displayed by pressing the key when past trip 1, 2, 3 or 4 is displayed. ⇒ For more details, refer to Section 8.2.2.

Note 6: The part replacement alarm is displayed based on the value calculated from the annual average ambient temperature, operation time and load current specified using $F \bar{5} \bar{3} \bar{4}$.

Use this alarm as a guide only, since it is based on a rough estimation.

Note 7: The cumulative operation time increments only when the machine is in operation.

■ Input terminal information

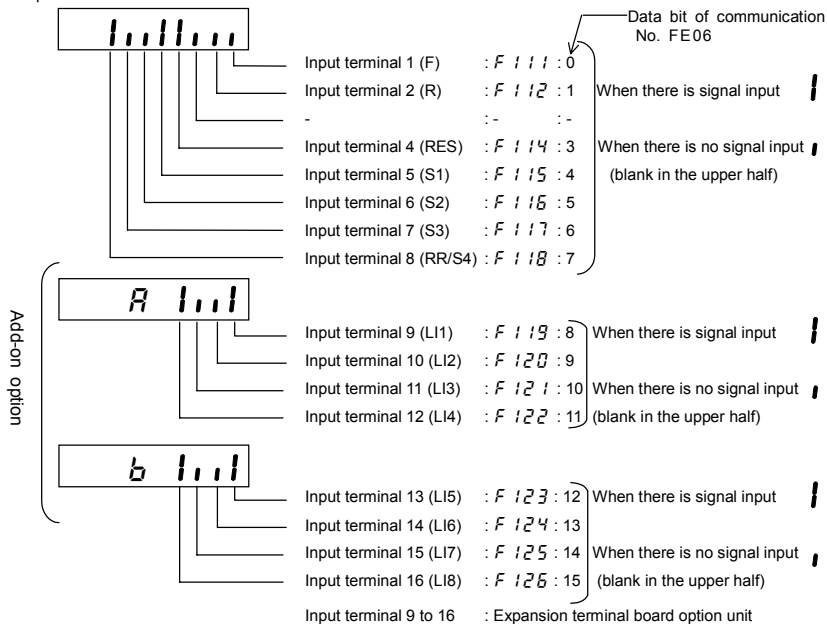

■ Output terminal information

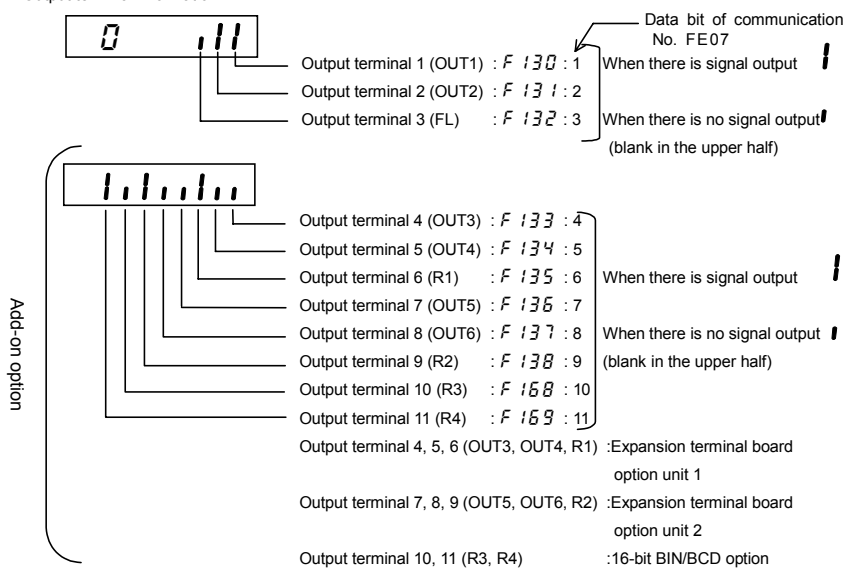

■ Cumulative operation time

For indication of cumulative operation hours, running hours are counted up when the output frequency monitor reads a frequency other than 0.0Hz. 10 hours is indicated as 0.1 (unit of Indication).



8

8.2.2 Display of detailed information on a past trip

Details on a past trip (of trips 1 to 4) can be displayed, as shown in the table below, by pressing the  key when the trip record is selected in the status monitor mode.

Unlike the " Monitor display at tripping " in 8.4.2, details on a past trip can be displayed, even after the inverter is turned off or reset.

	Item displayed	Key operated	LED display	Description
[Note 5]	Past trip 1			Past trip 1 (displayed alternately.)
	Continuous trips			The number of time the same trip occurred in succession is displayed. (Unit: times)
[Note 1]	Output frequency			The operation frequency when the trip occurred is displayed.
	Status monitor mode (Rotating direction)			The direction of rotation is displayed. (F :Forward run, r :Reverse run)
	Frequency command value			The operation frequency command value is displayed. (When F 7 1 1=1, Frequency command)
[Note 2]	Output current			The inverter output current (load current) is displayed. (When F 7 1 2=2, Output current)
[Note 2]	Input voltage (DC detection)			The inverter DC voltage is displayed. (Default setting unit: %) (When F 7 1 3=3, Input voltage) [Note 3]
[Note 2]	Output voltage			The inverter output voltage is displayed. (Default setting unit: %) (When F 7 1 4=4, output voltage)
	Input terminal information			The ON/OFF status of each of the control signal input terminals (F, R, PWR, S1, S2, S3, RR/S4) is displayed in bits.
[Note 4]	Output terminal information			The ON/OFF status of each of the control signal output terminals (OUT1, OUT2, FL) is displayed in bits.
[Note 6]	Cumulative operation time			The cumulative operation time when the trip occurred is displayed. (0.01=1 hour, 1.00=100 hours)
	Past trip 1			Press this key to return to past trip 1.

Note 1: Press the  or  key to change items displayed in the status monitor mode.

Note 2: You can switch between % and A (ampere)/V (volt), using the parameter *d5PU* (current/voltage unit selection).

Note 3: The input voltage displayed is $1/\sqrt{2}$ times as large as the rectified DC input voltage.

Note 4: The number of bars displayed varies depending on the setting of *F559* (logic output/pulse train output selection). The bar representing the OUT1 terminal is displayed only when logic output function is assigned to it.

If *F559*=0 : The bar representing OUT1 is displayed.

If *F559*=1 : The bar representing OUT1 is not displayed.

Note 5: If there is no trip record, *nErr* is displayed.

Note 6: The cumulative operation time increments only when the machine is in operation.

8.3 Changing status monitor function

■ Changing the display format while power is on

The item displayed in the standard monitor mode (*1 on the left side of table on page H-2), for example, operation frequency which is displayed by default in this way: " $=0.0$ " when power is on or " $0FF$ " when power is off, can be changed to any item shown on page H-7. This new format, however, will not display an assigned prefix such as ξ or ζ .

* Standard monitor mode \Rightarrow Standard monitor display selection ($F710$)

Title	Function	Adjustment range	Default setting
$F709$	Standard monitor hold function	0:Real time 1:Peak hold 2:Minimum hold	0
$F710$	Standard monitor display selection	0~73 \Rightarrow Refer to page H-7.	0

Specify how to output the monitored values that are assigned to status monitors 1 through 4.

If $F709$ is set to 0, the monitored values selected with $F710$ (standard monitor display selection parameter) are displayed one after another.

For peak hold values and minimum hold values, the minimum values in each operation mode are displayed. When the motor is at a standstill, the values monitored last are held as they were until the motor is started the next time.

The maximum and minimum values monitored after power is turned on or after the reset with the EASY key are always displayed no matter whether the motor is in operation or at a standstill.

■ Changing contents of status monitor indication

Regarding contents of status monitor indications appearing in the left column of the table on page H-2, those marked with *2 to *5 can be changed for others. Select a desirable monitor function from among optional monitor functions appearing on page H-7.

- | | |
|----------------------|--|
| *2 Frequency command | \Rightarrow Changeable by status monitor 1 display selection ($F711$). |
| *3 Output current | \Rightarrow Changeable by status monitor 2 display selection ($F712$). |
| *4 Input voltage | \Rightarrow Changeable by status monitor 3 display selection ($F713$). |
| *5 Output voltage | \Rightarrow Changeable by status monitor 4 display selection ($F714$). |

Title	Function	Adjustment range	Default setting
$F711$	Status monitor 1 display selection	0~73 \Rightarrow Refer to page H-7.	1
$F712$	Status monitor 2 display selection	Ditto	2
$F713$	Status monitor 3 display selection	Ditto	3
$F714$	Status monitor 4 display selection	Ditto	4

*If $F711$ to $F714$ are set at "0" (Output frequency) the operation frequency is not held in trip status.

[Setup values of monitor indication parameters (F 7 10~F 7 14)]

Communication No.	Default setting	Item displayed	Marking	Unit (Panel)	Unit (Communication)
FD00	0	Output frequency	60.0	Depends on F 703	0.01Hz
FE02	1	Frequency command value	60.0	Depends on F 703	0.01Hz
FE03	2	Output current	0.0	1% or dSPU	0.01%
FE04	3	Input voltage (DC detection)	4.0	1% or dSPU	0.01%
FE05	4	Output voltage	P.0	1% or dSPU	0.01%
FE15	5	Compensated frequency	60.0	Depends on F 703	0.01Hz
FE16	6	Speed feedback (real-time value)	0	Depends on F 703	0.01Hz
FE17	7	Speed feedback (1-second filter)	0	Depends on F 703	0.01Hz
FE18	8	Torque	9.0	1%	0.01%
FE19	9	Torque command	9.0	1%	0.01%
FE20	11	Torque current	c.0	1%	0.01%
FE21	12	Exciting current	0.0	1%	0.01%
FE22	13	PID feedback value	0	Depends on F 703	0.01Hz
FE23	14	Motor overload factor (OL2 data)	L.0	1%	0.01%
FE24	15	Inverter overload factor (OL1 data)	0.0	1%	0.01%
FE25	16	Regenerative braking resistance overload factor (OLr data)	r.0	1%	1%
FE28	17	Regenerative braking resistance load factor (% ED)	r.0	1%	1%
FE29	18	Input power	h.0	0.1kW	0.01kW
FE30	19	Output power	H.0	0.1kW	0.01kW
FE39	23	Optional AI2 input	J.0	1%	0.01%
FE35	24	RR/S4 input	J.0	1%	0.01%
FE36	25	V/III input	J.0	1%	0.01%
FE37	26	RX input	J.0	1%	0.01%
FE38	27	Optional AI1 input	J.0	1%	0.01%
FE40	28	FM output	R.0	1	0.01
FE41	29	AM output	R.0	1	0.01
(FA65)	31	Communication data output	[Note 3]	[Note 3]	[Note 3]
FE66	32	Attached to expansion I/O card 1 CPU version	1.0	-	-
FE67	33	Attached to expansion I/O card 2 CPU version	1.0	-	-
FE76	34	Integral input power	h.0	Depends on F 749	Depends on F 749
FE77	35	Integral output power	H.0	Depends on F 749	Depends on F 749
[Note 2] FE00	50	Signed output frequency	60.0	Depends on F 703	0.01Hz
[Note 2] FE02	51	Signed frequency command value	60.0	Depends on F 703	0.01Hz
[Note 2] FE15	52	Signed compensated frequency	60.0	Depends on F 703	0.01Hz
[Note 2] FE16	53	Signed speed feedback (real-time value)	0	Depends on F 703	0.01Hz
[Note 2] FE17	54	Signed speed feedback (1-second filter)	0	Depends on F 703	0.01Hz
[Note 2] FE18	55	Signed torque	9.0	1%	0.01%
[Note 2] FE19	56	Signed torque command	9.0	1%	0.01%
[Note 2] FE20	58	Signed torque current	c.0	1%	0.01%
[Note 2] FE22	59	Signed PID feedback value	0	Depends on F 703	0.01
[Note 2] FE37	60	Signed RX input	J.0	1%	0.01%
[Note 2] FE38	61	Signed optional AI2 input	J.0	1%	0.01%
FE90	71	Output speed	0	1min ⁻¹	1min ⁻¹
FA15	72	Communication option Reception counter	n	1	1
FA16	73	Communication option Error counter	n	1	1

Note 1: If any value other than the values in the above table is specified, the number "9999" is displayed.

Note 2: If a negative value is specified, the negative sign "-" is displayed. The negative sign "-" is affixed only to values displayed on the monitor. Keep in mind that no sign is affixed to any values read through a communications device.

Note 3: Data set with FA65-FA79 is displayed.

⇒ For details, refer to Instruction Manual (E6581413) specified in Section 6.36.

8.4 Display of trip information

8.4.1 Trip code display

If the inverter trips, an error code is displayed to suggest the cause. In the status monitor mode, the status when the inverter trip is held.

■ Display of trip information

Error code	Description	Communication/Error code Communication No.:FC90
<i>OC1</i>	Overcurrent during acceleration	1
<i>OC2</i>	Overcurrent during deceleration	2
<i>OC3</i>	Overcurrent during fixed speed operation	3
<i>OC1P</i>	Overcurrent flowing in element during acceleration (Overheat)	37
<i>OC2P</i>	Overcurrent flowing in element during deceleration (Overheat)	38
<i>OC3P</i>	Overcurrent flowing in element during fixed speed (Overheat)	39
<i>OCRA1</i>	U-phase arm overcurrent	5
<i>OCRA2</i>	V-phase arm overcurrent	6
<i>OCRA3</i>	W-phase arm overcurrent	7
<i>OCL</i>	Overcurrent (Loaded side overcurrent at start time)	4
<i>OCr</i>	Dynamic braking element overcurrent (200V-55kW or larger, 400V-90kW or larger)	36
<i>OH</i>	Overheating	16
<i>OH2</i>	Thermal trip stop command from external device	46
<i>OL1</i>	Inverter overload	13
<i>OL2</i>	Motor overload	14
<i>OLr</i>	Dynamic braking resistor overload	15
<i>OP1</i>	Overvoltage during acceleration	10
<i>OP2</i>	Overvoltage during deceleration	11
<i>OP3</i>	Overvoltage during fixed speed operation	12
<i>Ot</i>	Overtorque	32
<i>UC</i>	Low current operation	29
<i>UP1</i>	Undervoltage (main circuit power supply)	30
<i>Ut</i>	Under torque	60
<i>PrF</i>	Power removal error	59
<i>E</i>	Emergency stop	17
<i>EEP1</i>	E E P ROM fault (writing error)	18
<i>EEP2</i>	Initial read error (parameter initialization)	19
<i>EEP3</i>	Initial read error (parameter initialization)	20
<i>EF1</i>	Ground fault	33
<i>EF2</i>		34
<i>EPH0</i>	Output phase failure	9
<i>EPH1</i>	Input phase failure	8
<i>Err2</i>	Inverter RAM fault	21
<i>Err3</i>	Inverter ROM fault	22
<i>Err4</i>	CPU fault	23
<i>Err5</i>	Communication time-out error	24
<i>Err6</i>	Gate array fault	25
<i>Err7</i>	Output current detector error	26
<i>Err8</i>	Optional unit fault	27
<i>Etn</i>	Tuning error except Etn1~3	40
<i>Etn1</i>	<i>F410</i> tuning error	84
<i>Etn2</i>	<i>F412</i> tuning error	85
<i>Etn3</i>	<i>UL, ULu, F405~407</i> setting error	86
<i>E4P</i>	Inverter type error	41
<i>E-10</i>	Analog input terminal overvoltage	42

(Continued overleaf)

(Continued)

Error code	Description	Communication/Error code Communication No.:FC90
<i>E - 11</i>	Sequence error	43
<i>E - 12</i>	Encoder error	44
<i>E - 13</i>	Speed error (Over speed)	45
<i>E - 18</i>	Terminal input error	50
<i>E - 19</i>	Abnormal CPU2 communication	51
<i>E - 20</i>	V/f control error	52
<i>E - 21</i>	CPU1 fault	53
<i>E - 22</i>	Abnormal logic input voltage	54
<i>E - 23</i>	Option 1 error	55
<i>E - 24</i>	Option 2 error	56
<i>E - 25</i>	Stop position retaining error	57
<i>E - 26</i>	CPU2 fault	58
<i>E - 29</i>	Control power backup undervoltage	61
<i>S O U T</i>	Step-out (for PM motors only)	47
<i>n E r r (*)</i>	No error	0

Note: Past trip records (trip records retained or trips that occurred in the past) can be called up.

⇒ See Section 8.2.1

(*) This is not a trip code. This code is displayed to show the absence of error when the past trip monitor mode is selected.

8.4.2 Monitor display at tripping

At the occurrence of a trip, the same information as that displayed in the mode described in 8.2.1, "Status monitor under normal conditions," can be displayed, as shown in the table below, if the inverter is not turned off or reset.

To display trip information after turning off or resetting the inverter, follow the steps described in 8.2.2, "Display of detailed information a past trip."

■ Example of call-up of trip information

Communication No.	Item displayed	Key operated	LED display	Description
FC90	Trip information		<i>OP2</i>	Status monitor mode (The code blinks if a trip occurs.) The motor coasts and comes to a stop (coast stop).
-	Setting monitor mode		<i>RUH</i>	The first basic parameter "History function (<i>RUH</i>)" is displayed.
[Note 3] FE00	Output frequency		<i>40.0</i>	The operation frequency when the trip occurred is displayed.
FE01	Direction of rotation		<i>F r - F</i>	The direction of rotation when the trip occurred is displayed. (<i>F</i> :Forward run, <i>r</i> :Reverse run)
*1 -	Frequency command value		<i>50.0</i>	The operation command value when the trip occurred is displayed.
[Note 4] *2 -	Output current		<i>130</i>	The inverter output current at tripping (load current) is displayed.
[Note 4] [Note 5] *3 -	Input voltage (DC detection)		<i>141</i>	The inverter DC voltage at the occurrence of a trip is displayed.
[Note 4] *4 -	Output voltage		<i>100</i>	The inverter output voltage at the occurrence of a trip is displayed.
FE06	Input terminal information 1		<i>1111111</i>	The ON/OFF status of each of the control input terminals at tripping (F, R, RES, S1, S2, S3, RR/S4) is displayed in bits.
	Input terminal information 2		<i>R 1111</i>	The ON/OFF status of each of the optional control input terminals at tripping (LI1, LI2, LI3, LI4) is displayed in bits.
	Input terminal information 3		<i>b 1111</i>	The ON/OFF status of each of the optional control input terminals at tripping (LI5, LI6, LI7, LI8) is displayed in bits.
[Note 6] FE07	Output terminal information 1		<i>0 111</i>	The ON/OFF status of each of the control output terminals at tripping (OUT1, OUT2 and FL) is displayed in bits.
	Output terminal information 2		<i>11111111</i>	The ON/OFF status of each of the optional control output terminals (OUT3, OUT4, R1, OUT5, OUT6, R2, R3, R4) is displayed in bits.
FE08	CPU1 version		<i>u 100</i>	The version of the CPU1 is displayed.
FE73	CPU2 version		<i>c 100</i>	The version of the CPU2 is displayed.
[Note 7] FE10	Past trip 1		<i>OP3⇄1</i>	Past trip 1 (displayed alternately at 0.5-sec. intervals)
[Note 7] FE11	Past trip 2		<i>OH ⇄2</i>	Past trip 2 (displayed alternately at 0.5-sec. intervals)
[Note 7] FE12	Past trip 3		<i>OP3⇄3</i>	Past trip 3 (displayed alternately at 0.5-sec. intervals)
[Note 7] FE13	Past trip 4		<i>nErr⇄4</i>	Past trip 4 (displayed alternately at 0.5-sec. intervals)

(Continued overleaf)

(Continued)

Communication No.	Item displayed	Key operated	LED display	Description
[Note 8] FE79	Part replacement alarm information			<p>The ON/OFF status of each of the cooling fan, circuit board capacitor, main circuit capacitor or part replacement alarm of cumulative operation time is displayed in bits.</p> <div style="display: flex; align-items: center;"> <div style="margin-right: 10px;">ON: </div> <div style="margin-right: 10px;">OFF: </div> <div style="border: 1px solid black; padding: 5px;"> </div> </div> <p style="margin-left: 100px;"> Cumulative operation time Cooling fan Control circuit board capacitor Main circuit capacitor </p>
[Note 9] FE14	Cumulative operation time			The cumulative operation time is displayed. (Indication of 0.1 represents 10 hours.)
-	Default display mode			Status monitor mode (The code blinks if a trip occurs.) Reverts to the first trip indication.

Note 1: If trouble occurs while the CPU is being initialized after the inverter is turned on or reset, the trip record retaining function does not record it but displays a status monitor item.

Note 2: Contents of status indications of *1, *2, *3, and *4 can be selected from about 40 kinds of information. Contents of status indications that are set up at F 7 1 1~F 7 1 4 (status monitor 1 to 4 display mode) are displayed.

Note 3: Items displayed when a trip occurs can be changed by pressing or key.

Note 4: You can switch between % and A (ampere)/V (volt), using the parameter d 5 P U (current/voltage unit selection).

Note 5: The input voltage displayed is $1/\sqrt{2}$ times as large as the rectified DC input voltage.

Note 6: The number of bars displayed varies depending on the setting of F 5 5 5 (logic output/pulse train output selection). The bar representing the OUT-NO terminal is displayed only when logic output function is assigned to it.
 If F 5 5 5 = 0: The bar representing OUT-NO is displayed.
 If F 5 5 5 = 1: The bar representing OUT-NO is not displayed.

Note 7: Past trip records are displayed in the following sequence: 1 (latest trip record) ⇔ 2 ⇔ 3 ⇔ 4 (oldest trip record). If there is no trip record, n E r r is displayed.

Details on past trip record 1, 2, 3 or 4 can be displayed by pressing the key when past trip 1, 2, 3 or 4 is displayed. ⇒ For more details, refer to Section 8.2.2.

Note 8: The time elapsed before an end of part replacement alarm is issued is calculated from the average yearly ambient temperature, operation time and load current entered using F 5 3 4, and it is no more than an estimation, and therefore it should be used for reference purposes only.

Note 9: The cumulative operation time increments only when the machine is in operation.

Note 10: At the occurrence of a trip, maximum values are not always recorded and displayed for reasons of detecting time.

8.5 Display of alarm, pre-alarm, etc.

When the inverter alarm, pre-alarm, etc. occurred, the contents are displayed. (Some are not displayed.)

Listed below ones can be monitored via communication (FC91). Refer to 13.1 for the other alarms.

Bit	Description	Panel indication
0	Overcurrent pre-alarm	<i>C</i>
1	Inverter overload pre-alarm	<i>L</i>
2	Motor overload pre-alarm	<i>L</i>
3	Overheat pre-alarm	<i>H</i>
4	Overvoltage pre-alarm achieving PBR operation level	<i>P</i>
5	Main circuit undervoltage detected	<i>U V F F</i>
6	(Reservation area)	–
7	Low current alarm	–
8	Overtorque detection	–
9	Braking resistor overload pre-alarm	–
10	Cumulative operation time alarm	–
11	PROFIBUS/DeviceNet/CC-Link communication error	<i>E 1</i>
12	RS485 communication error	<i>E 2</i>
13	(Reservation area)	–
14	Forced deceleration stop because of a momentary power failure	<i>S E O P</i>
15	Pre-alarm stop because of prolonged lower-limit frequency operation	<i>L S E P</i>

Note: For each bit, "0" indicates normal condition and "1" indicates appearance of alarm, etc.

9. Measures to satisfy the standards

9.1 How to cope with the CE standard

In Europe, the EMC directive and the low-voltage directive, which took effect in 1996 and 1997, respectively, make it obligatory to put the CE mark on every applicable product to prove that it complies with the directives. Inverters do not work alone but are designed to be installed in a control panel and always used in combination with other machines or systems which control them, so they themselves are not considered to be subject to the EMC directive. However, the CE mark must be put on all inverters because they are subject to the low-voltage directive.

The CE mark must be put on all machines and systems with built-in inverters because such machines and systems are subject to the above directives. It is the responsibility of the manufacturers of such final products to put the CE mark on each one. If they are "final" products, they might also be subject to machine-related directives. It is the responsibility of the manufacturers of such final products to put the CE mark on each one. In order to make machines and systems with built-in inverters compliant with the EMC directive and the low-voltage directive, this section explains how to install inverters and what measures should be taken to satisfy the EMC directive.

We have tested representative models with them installed as described later in this manual to check for conformity with the EMC directive. However, we cannot check all inverters for conformity because whether or not they conform to the EMC direction depends on how they are installed and connected. Applicable EMC standards vary depending on the composition of the control panel in which the inverter is installed, the relationship with other electrical devices installed in the control panel, wiring conditions, equipment layout, and so on, so you should check whether your machine or system complies with EMC standards as a whole. Therefore, please verify for yourself whether your machine or system conforms to the EMC directive.

9.1.1 EMC directive

Inverters themselves are not subject to approval for CE marking.

The CE mark must be put on every final product that includes an inverter(s) and a motor(s). The VF-PS1 series of inverters complies with the EMC directive if an EMC filter recommended by Toshiba is connected to it and wiring is carried out correctly.

- EMC directive
89/336/EEC

The EMC standards are broadly divided into two categories; immunity- and emission-related standards, each of which is further categorized according to the operating environment of each individual machine. Since inverters are intended for use with industrial systems under industrial environments, they fall within the EMC categories listed in Table 1 below. The tests required for machines and systems as final products are almost the same as those required for inverters.

Table 1 (EMC standards)

Category	Subcategory	Product standards	Test standard
Emission	Radiated	IEC61800-3	EN55011
	Conducted		
Immunity	Electrostatic discharge		IEC61000-4-2
	Radiated, radio-frequency, electromagnetic field		IEC61000-4-3
	Electrical fast transient burst		IEC61000-4-4
	Surge		IEC61000-4-5
	Conducted disturbances, induced by radio-frequency field		IEC61000-4-6
	Voltage dips, short interruptions and voltage variations		IEC61000-4-11

9.1.2 Measures to satisfy the EMC directive

Concrete measures for EMC directive of CE markings are shown below.

■ **Models with a built-in EMC filter**

(1) 200V class: VFPS1-2004PL~2075PL

400V class: VFPS1-4007PL~4630KPC

The above mentioned models install EMC noise filter inside. So the conducted and radiated noise can be reduced, optional EMC noise filters are not needed.

(If a further noise reduction is required, insert an additional filter described in I-4 on the input side of the inverter.)

Table 2 EMC directive compliance

Inverter type	EMC plate type	Requirements		Conducted noise IEC61800-3 category C2 (EN55011 classA Group1)	Conducted noise IEC61800-3 category C3 (EN55011 classA Group2)
		PWM carrier frequency f_c (kHz)	Length of motor connecting cable (m)		
VFPS1-2004PL~ VFPS1-2015PL	EMP101Z	4	10	Built-in filter	-
		16	5		
VFPS1-2022PL	EMP102Z	4	10		
		16	5		
VFPS1-2037PL	EMP102Z	4	10	-	Built-in filter
		16	5		
VFPS1-2055PL, VFPS1-2075PL	EMP103Z	4	10	Built-in filter	-
		16	5		
VFPS1-4007PL~ VFPS1-4022PL	EMP101Z	4	10		
		16	5		
VFPS1-4037PL	EMP102Z	4	10		
		16	5		
VFPS1-4055PL~ VFPS1-4110PL	EMP103Z	4	10		
		16	5		
VFPS1-4150PL	EMP104Z	4	10		
		16	5		
VFPS1-4185PL	EMP104Z	2.5	25		
		16	25		
VFPS1-4220PL	EMP105Z	2.5	50		
		16	25		
VFPS1-4300PL, VFPS1-4370PL	EMP106Z	2.5	50		
		16	25		
VFPS1-4450PL~ VFPS1-4750PL	EMP108Z	2.5	50		
		16	25		
VFPS1-4900PC, VFPS1-4110KPC	-	2.5	50		
VFPS1-4132KPC	-	2.5	50		
VFPS1-4160KPC	-	2.5	50		
VFPS1-4220KPC	-	2.5	50		
VFPS1-4250KPC~ VFPS1-4315PL	-	2.5	50		
VFPS1-4400KPC, VFPS1-4500KPC,	-	2.5	50		
VFPS1-4630KPC,	-	2.5	50		

() : An optional regenerative braking unit PB7 is used.

9

- (2) Use shielded power cables and control signal cables for the input and output lines of the inverter. Route the cables and wires so as to minimize their lengths. Keep a distance between the power cable and the control cable and between the input and output wires of the power cable. Do not route them in parallel or bind them together, instead cross at right angle.
- (3) Install the inverter in an enclosed steel cabinet, it is more effective in limiting the radiation. Using wires as thick and short as possible, earth the control panel securely with a distance kept between the earth cable and the power cable.
- (4) To limit the radiation noise from cables, earth each shielded cable to the EMC plate. It is effective to earth shielded cables in the vicinity of the inverter and filter (within a radius of 10cm from each of them). Inserting a ferrite core in a shielded cable is even more effective in limiting the radiation noise.
- (5) To further limit the radiation noise, insert a zero-phase reactor in the inverter output line and insert ferrite cores in the earth cables of the EMC plate and cabinet.

[Ex. Countermeasure - inverter wiring]

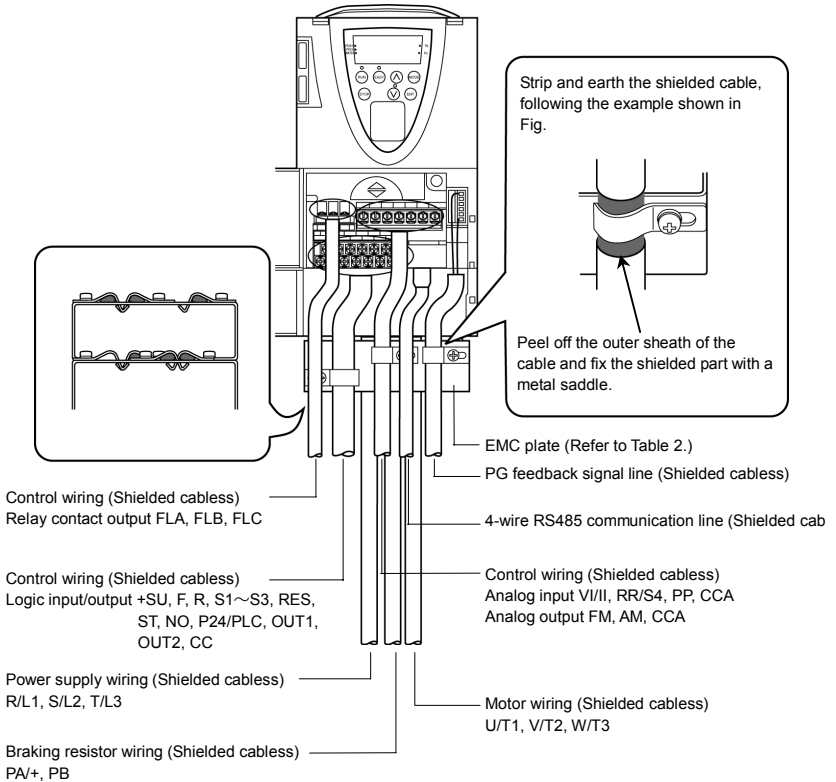

Fig. 1

■ When an external EMC filter is added

(1) Additional external EMC filters have the further effect of suppressing conduction and radiation noises. Use the recommended EMC noise filter specified in Table 3. This combination of inverter and filter was used when examining the inverter for compliance with the EMC directive.

Table 3 lists noise filters recommended for the inverters.

Table 3 Combinations of inverter and EMC filter

Inverter type	Requirements		Conducted noise IEC61800-3 category C2 (EN55011 classA Group1)	Conducted noise IEC61800-3 category C1 (EN55011 classB Group1)
	PWM carrier frequency ζF (kHz)	Length of motor connecting cable (m)	Applicable filters	Applicable filters
VFPS1-2004PL~ VFPS1-2015PL	3~4	50	EMF3-4012A	EMF3-4012A
		100	EMF3-4012A	-
	4.1~16	20	EMF3-4012A	EMF3-4012A
		50	EMF3-4012A	-
VFPS1-2022PL, VFPS1-2037PL	3~4	50	EMF3-4026B	EMF3-4026B
		100	EMF3-4026B	-
	4.1~16	20	EMF3-4026B	EMF3-4026B
		50	EMF3-4026B	-
VFPS1-2055PL	3~4	50	EMF3-4035C	EMF3-4035C
		100	EMF3-4035C	-
	4.1~16	20	EMF3-4035C	EMF3-4035C
		50	EMF3-4035C	-
VFPS1-2075PL	3~4	50	EMF3-4046D	EMF3-4046D
		100	EMF3-4046D	-
	4.1~16	20	EMF3-4046D	EMF3-4046D
		50	EMF3-4046D	-
VFPS1-2110PM, VFPS1-2150PM	3.5~4	50	EMF3-4072E	EMF3-4072E
		100	EMF3-4072E	-
	4.1~12	25	EMF3-4072E	EMF3-4072E
		50	EMF3-4072E	-
VFPS1-2185PM, VFPS1-2220PM	2~2.5	50	EMF3-4090F	EMF3-4090F
		100	EMF3-4090F	-
	2.6~12	25	EMF3-4090F	EMF3-4090F
		50	EMF3-4090F	-
VFPS1-2300PM~ VFPS1-2450PM	2~2.5	50	EMF3-4180H	EMF3-4180H
		100	EMF3-4180H	-
	2.6~12	25	EMF3-4180H	EMF3-4180H
		50	EMF3-4180H	-
VFPS1-2550P, VFPS1-2750P	2~4	50	EMF3-4300I	EMF3-4300I
		100	EMF3-4300I	-
	4.1~8	25	EMF3-4300I	EMF3-4300I
		50	EMF3-4300I	-
VFPS1-2900P	2~4	50	EMF3-4600J	EMF3-4600J
		100	EMF3-4600J	-
	4.1~8	25	EMF3-4600J	EMF3-4600J
		50	EMF3-4600J	-
VFPS1-4007PL~ VFPS1-4022PL	3~4	50	EMF3-4012A	EMF3-4012A
		100	EMF3-4012A	-
	4.1~16	20	EMF3-4012A	EMF3-4012A
		50	EMF3-4012A	-
VFPS1-4037PL	3~4	50	EMF3-4026B	EMF3-4026B
		100	EMF3-4026B	-
	4.1~16	20	EMF3-4026B	EMF3-4026B
		50	EMF3-4026B	-
VFPS1-4055PL, VFPS1-4075PL	3~4	50	EMF3-4035C	EMF3-4035C
		100	EMF3-4035C	-
	4.1~16	20	EMF3-4035C	EMF3-4035C
		50	EMF3-4035C	-
VFPS1-4110PL	3~4	50	EMF3-4046D	EMF3-4046D
		100	EMF3-4046D	-
	4.1~16	20	EMF3-4046D	EMF3-4046D
		50	EMF3-4046D	-

(Continued overleaf)

(Continued)

Inverter type	Requirements		Conducted noise	Conducted noise
	PWM carrier frequency f_c (kHz)	Length of motor connecting cable (m)	IEC61800-3 category C2 (EN55011 classA Group1) Applicable filters	IEC61800-3 category C1 (EN55011 classB Group1) Applicable filters
VFPS1-4150PL, VFPS1-4185PL	3.5~4	100	EMF3-4072E	EMF3-4072E
		300	EMF3-4072E	-
	4.1~12	100	EMF3-4072E	EMF3-4072E
		200	EMF3-4072E	-
VFPS1-4220PL	3.5~4	100	EMF3-4090F	EMF3-4090F
		300	EMF3-4090F	-
	4.1~12	100	EMF3-4090F	EMF3-4090F
		200	EMF3-4090F	-
VFPS1-4300PL	3.5~4	100	EMF3-4092G	EMF3-4092G
		300	EMF3-4092G	-
	4.1~12	100	EMF3-4092G	EMF3-4092G
		200	EMF3-4092G	-
VFPS1-4370PL	2~2.5	100	EMF3-4092G	EMF3-4092G
		300	EMF3-4092G	-
	2.6~12	100	EMF3-4092G	EMF3-4092G
		200	EMF3-4092G	-
VFPS1-4450PL~ VFPS1-4750PL	2~2.5	100	EMF3-4180H	EMF3-4180H
		300	EMF3-4180H	-
	2.6~12	100	EMF3-4180H	EMF3-4180H
		200	EMF3-4180H	-
VFPS1-4900PC~ VFPS1-4160KPC	2.5~4	50	EMF3-4300I	EMF3-4300I
		300	EMF3-4300I	-
	4.1~8	25	EMF3-4300I	EMF3-4300I
		150	EMF3-4300I	-
VFPS1-4220KPC~ VFPS1-4315KPC	2.5~4	50	EMF3-4600J	EMF3-4600J
		300	EMF3-4600J	-
	4.1~8	25	EMF3-4600J	EMF3-4600J
		150	EMF3-4600J	-
VFPS1-4400KPC	2.5~4	50	EMF3-4800K	EMF3-4800K
		300	EMF3-4800K	-
	4.1~8	25	EMF3-4800K	EMF3-4800K
		150	EMF3-4800K	-
VFPS1-4500KPC, VFPS1-4630KPC	2.5~4	50	EMF3-4600J × 2	EMF3-4600J × 2
		300	EMF3-4600J × 2	-
	4.1~8	25	EMF3-4600J × 2	EMF3-4600J × 2
		150	EMF3-4600J × 2	-

- (2) Use shielded cables for the power and control cables, including filter input cables and inverter output cables. Route the cables and wires so as to minimize their lengths. Keep a distance between the power cable and the control cable and between the input and output wires of the power cable. Do not route them in parallel or bind them together, instead cross at right angle.
- (3) Install the filter and the inverter in an enclosed steel cabinet, it is more effective in limiting the radiation. Earth the cabinet body securely with the thickest and shortest possible electric wire installed away from the power cables.
- (4) Route the EMC filter input and output wires apart from each other.
- (5) To limit the radiation noise from cables, earth each shielded cable to the EMC plate. It is effective to earth shielded cables in the vicinity of the inverter and filter (within a radius of 10cm from each of them). Inserting a ferrite core in a shielded cable is even more effective in limiting the radiation noise.
- (6) To further limit the radiation noise, insert a zero-phase reactor in the inverter output line and insert ferrite cores in the earth cables of the EMC plate and cabinet.

[Ex. Countermeasure - inverter wiring]

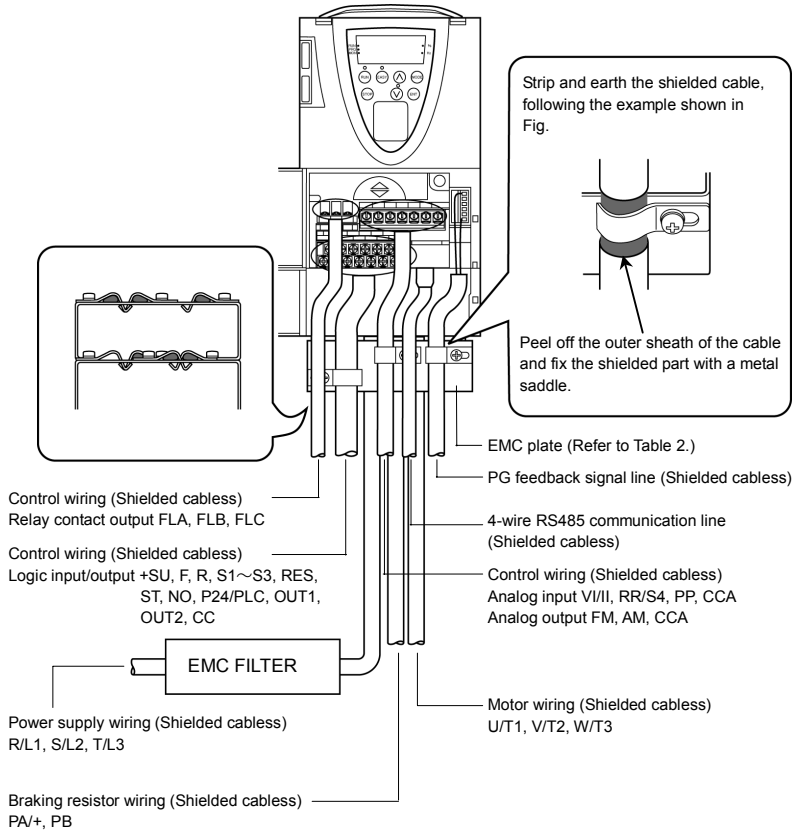

Fig. 2

[Operation with external signals]

When using signals from an external control device to operate the inverter, take the measures shown in Figure 3.
Ex.) When using the potentiometer and forward run/reverse run terminals

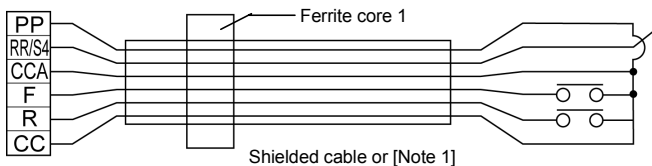

Fig. 3

[Accessories for countermeasure]

- Recommended shield cable : Showa electric Wire & Cable Co., LTD
 - Type : CV-S
 - Rating : 600V or less
 - Cross-sectional area : 2~1000mm²
- If it is difficult to procure shielded cables, protect cables with conduit tubes.
- [Note 1] Recommended shield : SUMITOMO 3M Limited, Electromagnetic wave guard shielding sleeve
 - Type : DS-5, 7, 10, 14
- EMC filter : Type : EMF3 series
- Recommended ferrite core 1 : TDK Corporation
 - Type : ZCAT3035-1330
- Use the following, as required.
- Recommended ferrite core : NEC TOKIN Corporation
 - Type : ESD-R-47D-1
- Zero-phase reactor : Soshin Electric Co., Ltd.
 - Type : RC5078 or RC9129
- High-attenuation radio noise reduction filter : Soshin Electric Co., Ltd.
 - Type : NF series

9.1.3 Low-voltage directive

The low-voltage directive provides for the safety of machines and systems. All Toshiba inverters are CE-marked in accordance with the standard IEC61800-5-1 specified by the low-voltage directive, and can therefore be installed in machines or systems and imported without a problem to European countries.

Applicable standard: IEC61800-5-1

Adjustable speed electrical power drive system

Pollution level: 2 (5.2.15.2)

Overvoltage category: 3 200V class, 3.0mm (5.2.16.1)
 400V class, 5.5mm (5.2.16.1)

9.1.4 Measures to be taken to satisfy the low-voltage directive

When incorporating the inverter into a machine or system, it is necessary to take the following measures so that the inverter satisfies the low-voltage directive.

- (1) Install the inverter in a cabinet and ground the inverter enclosure. When doing maintenance, be extremely careful not to put your fingers into the inverter through a wiring hole and touch a charged part, which may occur depending on the model and capacity of the inverter used.
- (2) Do not connect two or more wires to the main circuit earth terminal of the inverter. If necessary, install an additional earth terminal on the EMC plate on which the inverter is installed and connect another cable to it. (Refer to Fig. 4.) See the table of section 10.1.

(3) Install a non-fuse circuit breaker on the input side of the inverter.

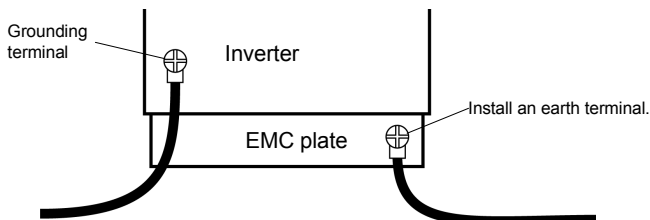

Fig. 4

9.2 Measures to be taken to satisfy the UL/CSA standards

All VF-PS1 series inverters are certified by UL and CSA, and have nameplates with UL and CSA markings.

9.2.1 Caution in installing the inverter

A UL certificate was granted on the assumption that the inverter would be installed in a cabinet. Therefore, install the inverter in a cabinet and if necessary, take measures to maintain the ambient temperature (temperature in the cabinet) within the specified temperature range.

For models designed for 15kW motors or smaller, if the cover on the top of the inverter is removed, the ambient temperature can rise to 50°C in some cases, although the maximum allowable ambient temperature is 40°C. Incidentally, models (with no cover on the top) designed for 18.5 kW motors or larger can be used at ambient temperatures of up to 50°C.

9.2.2 Caution in wiring and rated current

For electric wires to be connected to the inverter's input terminals (R/L1, S/L2, T/L3), output terminals (U/T1, V/T2, W/T3) or other main circuit terminals, use UL-certified electric wires (copper wires with conductors for which the maximum allowable temperature is 75°C or over) and round solderless terminals and tighten the terminal screws (stripped wires may be connected directly for 200V/18.5kW to 200V/45kW models and 400V/22kW to 400V/75kW models) to the specified torque when connecting the wires to the terminal board. To crimp a round solderless terminal onto a wire, use a crimping tool recommended by the terminal manufacturer.

⇒ For recommended electric wire sizes, see Tables 5.

UL-certified rated output current is not the same as inverter unit rated current. Refer to Table 5.

9.2.3 Caution as to peripheral devices

When installing a no-fuse circuit breaker or a fuse box on the primary side of the inverter, use UL-certified one.

The UL certification test on this inverter was conducted under the AIC* conditions shown in Table 4 (*: current that flows in the event of a short-circuit in the power supply). Note that AIC currents vary depending on the capacity of the motor used.

Table 4 AIC and maximum input voltage

Applicable motor (kW)	AIC (A)	Max. input voltage (V)	
		200V class	400V class
0.4~37	5,000	240	480
45~132	10,000		
160~280	18,000		
315, 400	30,000		
500, 630	42,000		

Table 5 AIC, Fuse and Wire sizes

Voltage class	Applicable motor [kW]	Inverter model	UL output current (A) *1, *2	AIC (A) (Interrupting capacity)	Fuse class and current (A)	Input wire sizes of power circuit (AWG) *3	Output wire sizes of power circuit (AWG) *3	Grounding wire (AWG) *3
200V class	0.4	VFPS1-2004PL	2.5 (CF=4)	AIC 5000A	CC 7Amax.	14	14	14
	0.75	VFPS1-2007PL	4.8 (CF=4)	AIC 5000A	J 15Amax.	14	14	14
	1.5	VFPS1-2015PL	7.8 (CF=4)	AIC 5000A	J 25Amax.	14	14	14
	2.2	VFPS1-2022PL	11.0 (CF=4)	AIC 5000A	J 25Amax.	12	12	14
	3.7	VFPS1-2037PL	17.5 (CF=4)	AIC 5000A	J 45Amax.	10	10	12
	5.5	VFPS1-2055PL	25.3 (CF=4)	AIC 5000A	J 60Amax.	8	8	10
	7.5	VFPS1-2075PL	32.2 (CF=4)	AIC 5000A	J 70Amax.	8	8	10
	11	VFPS1-2110PM	48.3 (CF=4)	AIC 5000A	J 90Amax.	4	4	10
	15	VFPS1-2150PM	62.1 (CF=4)	AIC 5000A	J 110Amax.	4	4	10
	18.5	VFPS1-2185PM	74.8 (CF=2.5)	AIC 5000A	J 125Amax.	3	3	8
	22	VFPS1-2220PM	88 (CF=2.5)	AIC 5000A	J 150Amax.	2	2	8
	30	VFPS1-2300PM	114 (CF=2.5)	AIC 5000A	J 200Amax.	2/0	2/0	6
	37	VFPS1-2370PM	143 (CF=2.5)	AIC 5000A	J 225Amax.	3/0	3/0	6
	45	VFPS1-2450PM	169 (CF=2.5)	AIC 10000A	J 300Amax.	4/0	4/0	6
	55	VFPS1-2550P	221 (CF=2.5)	AIC 10000A	J 350Amax.	3/0×2	3/0×2	1/0
75	VFPS1-2750P	285 (CF=2.5)	AIC 10000A	J 350Amax.	4/0×2	4/0×2	1/0	
90	VFPS1-2900P	359 (CF=2.5)	AIC 10000A	J 450Amax.	250MCM×2	250MCM×2	1/0	
400V class	0.75	VFPS1-4007PL	2.1 (CF=4)	AIC 5000A	CC 6Amax.	14	14	14
	1.5	VFPS1-4015PL	3.4 (CF=4)	AIC 5000A	CC 12Amax.	14	14	14
	2.2	VFPS1-4022PL	4.8 (CF=4)	AIC 5000A	J 15Amax.	14	14	14
	3.7	VFPS1-4037PL	7.6 (CF=4)	AIC 5000A	J 25Amax.	12	12	14
	5.5	VFPS1-4055PL	11.0 (CF=4)	AIC 5000A	J 40Amax.	10	10	12
	7.5	VFPS1-4075PL	14.0 (CF=4)	AIC 5000A	J 40Amax.	10	10	12
	11	VFPS1-4110PL	21.0 (CF=4)	AIC 5000A	J 60Amax.	8	8	10
	15	VFPS1-4150PL	27.0 (CF=4)	AIC 5000A	J 70Amax.	6	6	10
	18.5	VFPS1-4185PL	34.0 (CF=4)	AIC 5000A	J 70Amax.	6	6	10
	22	VFPS1-4220PL	40.0 (CF=4)	AIC 5000A	J 80Amax.	6	6	10
	30	VFPS1-4300PL	52.0 (CF=4)	AIC 5000A	J 90Amax.	4	4	10
	37	VFPS1-4370PL	65.0 (CF=2.5)	AIC 5000A	J 110Amax.	3	3	8
	45	VFPS1-4450PL	77.0 (CF=2.5)	AIC 10000A	J 150Amax.	1	1	8
	55	VFPS1-4550PL	96.0 (CF=2.5)	AIC 10000A	J 175Amax.	1/0	1/0	6
	75	VFPS1-4750PL	124.0 (CF=2.5)	AIC 10000A	J 225Amax.	3/0	3/0	6
	90	VFPS1-4900PC	179.0 (CF=2.5)	AIC 10000A	J 250Amax.	1/0×2	1/0×2	2
	110	VFPS1-4110KPC	215.0 (CF=2.5)	AIC 10000A	J 250Amax.	2/0×2	2/0×2	2
	132	VFPS1-4132KPC	259.0 (CF=2.5)	AIC 10000A	J 300/315Amax.	4/0×2	4/0×2	1
	160	VFPS1-4160KPC	314.0 (CF=2.5)	AIC 18000A	J 400Amax.	250MCM×2	250MCM×2	1
	220	VFPS1-4220KPC	427.0 (CF=2.5)	AIC 18000A	J 500Amax.	350MCM×2	350MCM×2	2/0
	250	VFPS1-4250KPC	481.0 (CF=2.5)	AIC 18000A	T 550/600Amax.	250MCM×3	250MCM×3	2/0
280	VFPS1-4280KPC	550.0 (CF=2.5)	AIC 18000A	T 600/630Amax.	300MCM×3	300MCM×3	3/0	
315	VFPS1-4315KPC	616.0 (CF=2.5)	AIC 30000A	T 800Amax.	350MCM×3	350MCM×3	3/0	
400	VFPS1-4400KPC	759.0 (CF=2.5)	AIC 30000A	Semiconductor 900Amax.	350MCM×4	350MCM×4	4/0	
500	VFPS1-4500KPC	941.0 (CF=2.5)	AIC 42000A	J 600/630A × 2 max.	500MCM×2×2	500MCM×4	250MCM	
630	VFPS1-4630KPC	1188.0 (CF=2.5)	AIC 42000A	J 800A × 2 max.	500MCM×3×2	500MCM×6	350MCM	

*1: UL output current is different from unit rating output current.

*2: The value of the UL rated output current is applicable when the carrier frequency (CF) is less than the value shown in the table.

*3: The cables used must be 75°C copper cables within 40°C ambient temperature.

9.2.4 Caution as to the protection of motors from overload

When using the inverter's thermal protection function to protect the motor from overload, read the instruction manual included with the inverter carefully and set parameters according to the specifications of the motor used.

When using the inverter to control the operation of multiple motors, install an overload relay for each individual motor.

9.3 Compliance with safety standards

The VFPS1 inverter has the "power removal" safety function that complies with safety standards.

To ensure safety performance, however, the mechanical system with which the VFPS1 inverter is used has to adhere to such standards as a whole.

To be more specific, in order for the system to satisfy the following safety standards, it needs to be configured, as shown on the next page, with the power removal terminal of the VFPS1 inverter (PWR terminal on the control terminal board) so that it will coast or decelerate to a stop in the event of a failure.

To ensure that the motor coasts or decelerates to a stop if an unusual event occurs, the power removal circuit is designed with redundancy and it has a diagnosis circuit that determines whether the unusual event is at a permissible level or not, in addition to a hardware circuit and software that cut off the operation signal if the unusual event is judged impermissible. This safety function is certified by the certification organization "INERIS."

- The VFPS1 inverter meets the IEC/EN61508 SIL2 requirements.
(The term "SIL" is an acronym for "Safety Integrity Level," which is a safety performance scale.)
- The VFPS1 inverter falls under Category 3 of the safety standard EN954-1 for mechanical systems.
- The VFPS1 inverter supports the two stopping methods defined in IEC/EN61800-5-2.
One is "STO," which refers to "coast and stop," and the other is "ST1," which refers to "deceleration stop."

EN61508 is an international standard that defines safety performance required for systems provided with electric and electronic programmable devices, and SIL2 applies to systems that are configured with dangerous failure rates of as low as 10^{-6} to 10^{-7} , as shown in the table below. For the relationship between SIL and inverter configuration, see the following pages.

<<Target for IEC/EN61508 safety performance scale>>

SIL	Heavy-duty operation mode or continuous operation mode (Hourly dangerous failure rate)
4	$10^{-9} \sim 10^{-8}$
3	$10^{-8} \sim 10^{-7}$
2	$10^{-7} \sim 10^{-6}$
1	$10^{-6} \sim 10^{-5}$

The European standard EN954-1, a basic safety standard for mechanical system, categorizes machines by degree of danger.

Placed in Category 3 are machines that are designed with redundancy so that a single failure will not cause a degradation in their safety performance.

For the relationship between each category and the safety function, see the table below.

<<Categories relating to safety according to EN 954-1>>



Categories	Basic safety principle	Control system requirements	Behavior in the event of a fault
B	Selection of components that conform to relevant standards.	Control in accordance with good engineering practice.	Possible loss of safety function.
1	Selection of components and basic safety principles.	Use of tried and tested components and proven safety principles.	Possible loss of safety function, but with less probability of this than with B
2	Selection of components and basic safety principles.	Cyclic testing. The test intervals must be suited to the machine and its applications.	Fault detected at each test.
3	Structure of the safety circuits.	A single fault must not cause loss of the safety function. This single fault must be detected if reasonably practicable.	Safety function ensured, except in the event of an accumulation of faults.
4	Structure of the safety circuits.	A single fault must not cause loss of the safety function. This fault must be detected at or before the next demand on the safety function. An accumulation of faults must not cause loss of the safety function.	Safety function always ensured.

The three stopping methods described on the following pages were selected in accordance with IEC60204-1.

Stopping method 1 (Stop category 0): Stops the mechanical system by cutting off the power supply immediately.

Stopping method 2 (Stop category 1): First controls the mechanical system to stop it, and then cuts off the power supply.

Stopping method 3 (Stop category 2): First cut off the power supply, and then controls the mechanical system to stop it.

 Caution	
	For preventive maintenance, check at least once a year whether the power removal safety function operates normally.
Mandatory	

Safety category1:	EN954-1 category1, IEC/EN61508, SIL1
Stop category1:	IEC/EN60204-1
Coast stop under the control of the MC in the main circuit	

(1) An example of connection for operation in sink mode (common: CC)

- In this connection, the PWR terminal is not used. This connection falls under Stop Category 0 defined in IEC/EN60204-1.

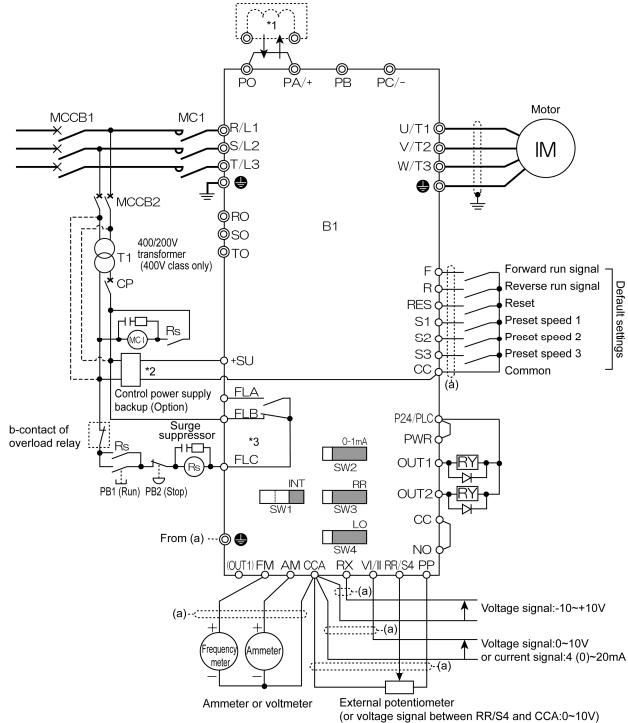

Symbols	Description
B1	VF-PS1 inverter
MCCB1	Circuit breaker
MC1	Magnetic conductor
MCCB2	Circuit breaker for control transformer
T1	Control transformer 400/200V (For 400V class only)
CP	Circuit protector
PB1	Push button switch (Run)
PB2	Push button switch (Stop/emergency stop)
Rs	Control relay

1: Some inverters are shipped with the PO and PA/+ terminals short-circuited with a shorting bar. (* 200V/45kW class and lower and 400V/75kW class and lower)

*2: To back up the inverter's internal power supply that supplies control power, an external control power backup device (CPS002Z - optional) is required. The optional control power backup device can be used with both 200V and 400V classes.

*3: By default, the FL relay is set as a failure FL output relay.

Safety category1:	EN954-1 category1, IEC/EN61508, SIL1
Stop category0:	IEC/EN60204-1
Coast stop under the control of the MC in the main circuit	

(2) An example of connection for operation in source mode (common: P24)

- In this connection, the PWR terminal is not used. This connection falls under Stop Category 0 defined in IEC/EN60204-1.

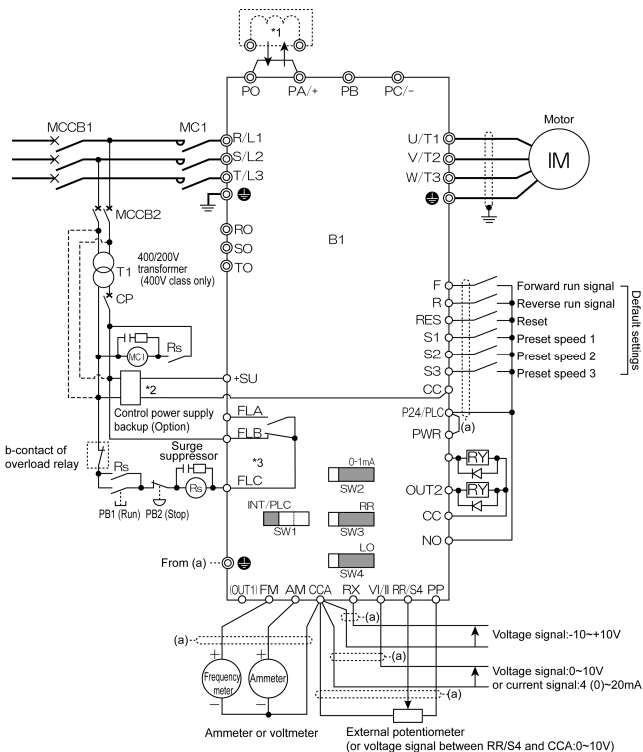

Symbols	Description
B1	VF-PS1 inverter
MCCB1	Circuit breaker
MC1	Magnetic condactor
MCCB2	Circuit breaker for control transformer
T1	Control transformer 400/200V (For 400V class only)
CP	Circuit protector
PB1	Push button switch (Run)
PB2	Push button switch (Stop/emergency stop)
Rs	Control relay

1: Some inverters are shipped with the PO and PA/+ terminals short-circuited with a shorting bar. (* 200V/45kW class and lower and 400V/75kW class and lower)

*2: To back up the inverter's internal power supply that supplies control power, an external control power backup device (CPS002Z - optional) is required. The optional control power backup device can be used with both 200V and 400V classes.

*3: By default, the FL relay is set as a failure FL output relay.

Safety category3:	EN954-1 category3, IEC/EN61508, SIL2
Stop category0:	IEC/EN60204-1
Coast stop under the control of PWR	

(1) An example of connection for operation in sink mode (common: CC)

- In this connection, the PWR terminal is used to connect a safety device. The emergency stop circuit is supervised by the external safety relay. This safety relay can be shared among several inverters.
- If the PWR terminal is turned off, the motor will coast and stop. This operation falls under Stop Category 0 defined in IEC/EN60204-1.
- The motor is prevented from restarting automatically before the PWR terminal is turned back on.
- When using the inverter to control the operation of a mechanical brake (for example, when using with a hoist or crane), connect the cable from the output terminal of the safety relay to the brake control circuit.

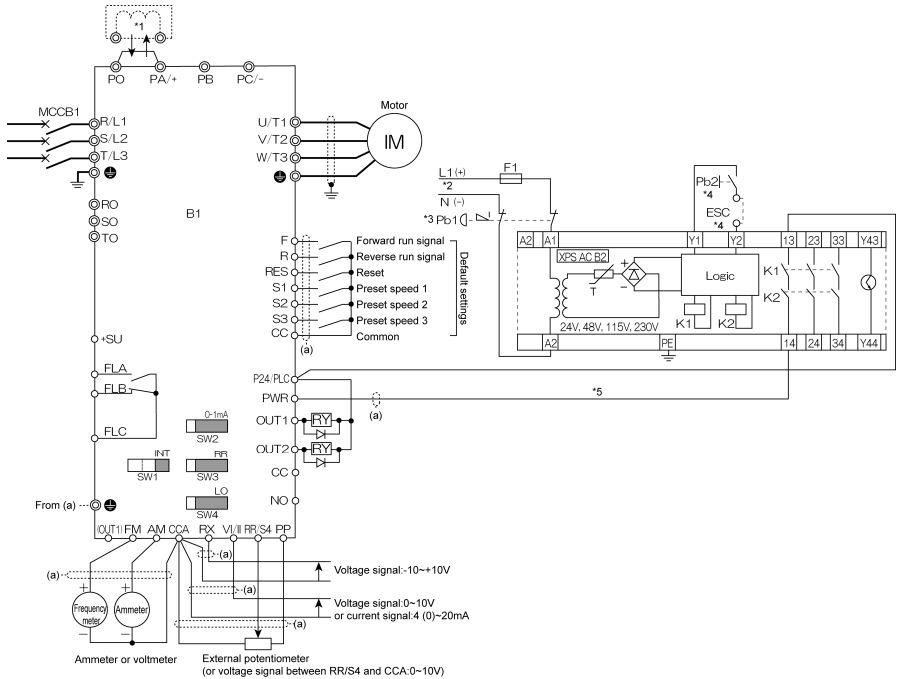

Symbols	Description
B1	VF-PS1 inverter
MCCB1	Circuit breaker
B2	Safety relay: XPS-AC (manufactured by Schneider Electric)
F1	Fuse
Pb1	Push button switch 2b contact (for emergency stop)
Pb2	Push button switch (for reset and start)

- *1: Some inverters* are shipped with the PO and PA/+ terminals short-circuited with a shorting bar. (* 200V/45kW class and lower and 400V/75kW class and lower)
- *2: Supply voltage: AC/DC24V, AC48V, AC115V, AC230V
- *3: If an emergency stop command is issued, the PWR terminal will be turned off to coast and stop the motor.
- *4: Pb2 is used to reset/start the inverter after the power is turned on or in the event of an emergency stop. ESC is used to set reset/start conditions for the external device.
- *5: To connect a safety relay to the PWR terminal, use a coaxial cable RG174/U (MIL-C17) or KX3B (NFC93-550) 2.54 mm or more in outside diameter and 2 m or less in length. When using a shielded cable, ground it.

Safety category3:	EN954-1 category3, IEC/EN61508, SIL2
Stop category0:	IEC/EN60204-1
Coast stop under the control of PWR	

(2) An example of connection for operation in source mode (common: P24)

- In this connection, the PWR terminal is used to connect a safety device. The emergency stop circuit is supervised by the external safety relay. This safety relay can be shared among several inverters.
- If the PWR terminal is turned off, the motor will coast and stop. This operation falls under Stop Category 0 defined in IEC/EN60204-1.
- The motor is prevented from restarting automatically before the PWR terminal is turned back on.
- When using the inverter to control the operation of a mechanical brake (for example, when using with a hoist or crane), connect the cable from the output terminal of the safety relay to the brake control circuit.

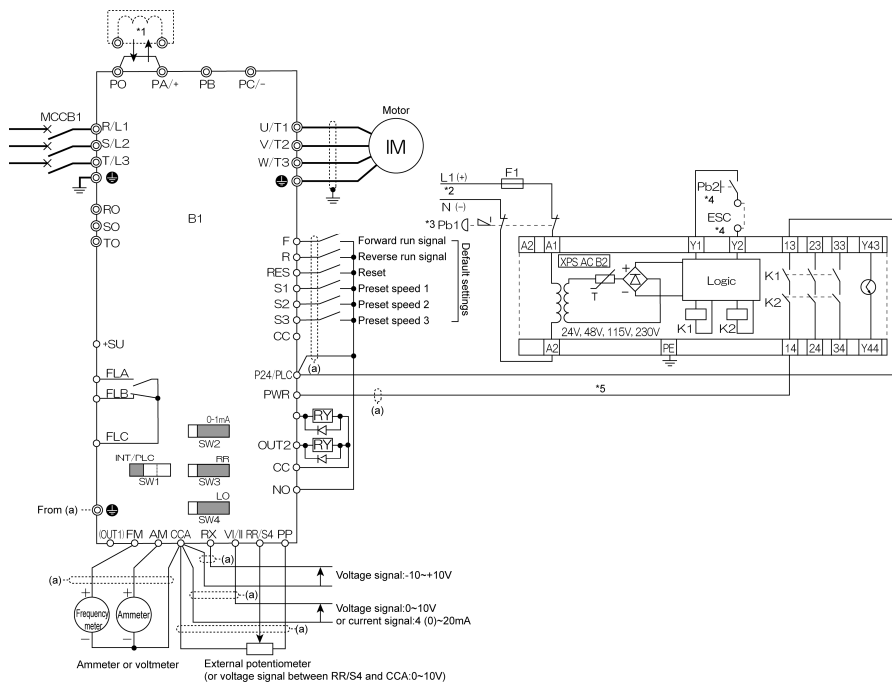

Symbols	Description
B1	VF-PS1 inverter
MCCB1	Circuit breaker
B2	Safety relay: XPS-AC (manufactured by Schneider Electric)
F1	Fuse
Pb1	Push button switch 2b contact (for emergency stop)
Pb2	Push button switch (for reset and start)

1: Some inverters are shipped with the PO and PA/+ terminals short-circuited with a shorting bar. (* 200V/45kW class and lower and 400V/75kW class and lower)

*2: Supply voltage: AC/DC24V, AC48V, AC115V, AC230V

*3: If an emergency stop command is issued, the PWR terminal will be turned off to coast and stop the motor.

*4: Pb2 is used to reset/start the inverter after the power is turned on or in the event of an emergency stop. ESC is used to set reset/start conditions for the external device.

*5: To connect a safety relay to the PWR terminal, use a coaxial cable RG174/U (MIL-C17) or KX3B (NFC93-550) 2.54 mm or more in outside diameter and 2 m or less in length. When using a shielded cable, ground it.

Safety category3:	EN954-1 category3, IEC/EN61508, SIL2
Stop category1:	IEC/EN60204-1
Deceleration stop under the control of PWR	

(1) An example of connection for operation in sink mode (common: CC)

- In this connection, the PWR terminal is used to connect a safety device. The emergency stop circuit is supervised by the external safety relay. This safety relay can be shared among several inverters.
- In the event of an emergency stop, the external safety relay issues a deceleration command to the inverter. At this command, the motor slows down and stops. Then, the safety relay turns off the PWR terminal on expiration of the time limit (max. 30 sec) set for the relay. This operation falls under Stop Category 1 defined in IEC/EN60204-1.
- For this connection, the function of issuing the forward run command (2) needs to be assigned to the F terminal, and the function of issuing the reverse run command (4) to the R terminal.

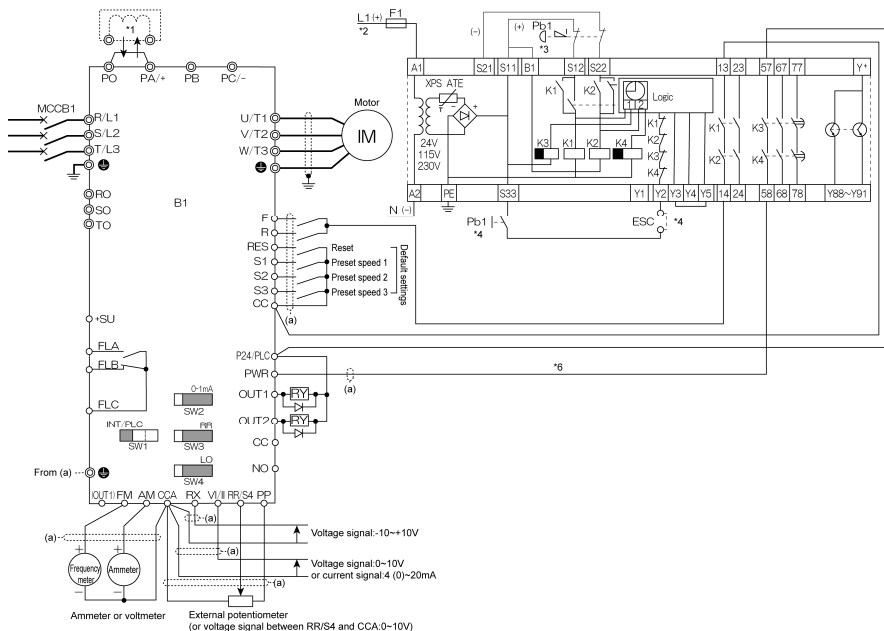

Symbols	Description
B1	VF-PS1 inverter
MCCB1	Circuit breaker
B2	Safety relay: XPS-ATE (manufactured by Schneider Electric)
F1	Fuse
Pb1	Push button switch 2b contact (for emergency stop)
Pb2	Push button switch (for reset and start)

- *1: Some inverters* are shipped with the PO and PA/+ terminals short-circuited with a shorting bar. (* 200V/45kW class and lower and 400V/75kW class and lower)
- *2: Supply voltage: AC/DC24V, AC48V, AC115V, AC230V
- *3: If an emergency stop command is issued, the PWR terminal will be turned off to coast and stop the motor.
- *4: Pb2 is used to reset/start the inverter after the power is turned on or in the event of an emergency stop. ESC is used to set reset/start conditions for the external device.
- *5: If a deceleration time of more than 30 seconds is required, use a safety relay XPS-AV, which allows you to set the deceleration time at a maximum of 300 seconds.
- *6: To connect a safety relay to the PWR terminal, use a coaxial cable RG174/U (MIL-C17) or KX3B (NFC93-550) 2.54 mm or more in outside diameter and 2 m or less in length. When using a shielded cable, ground it.

Safety category3:	EN954-1 category3, IEC/EN61508, SIL2
Stop category1:	IEC/EN60204-1
Deceleration stop under the control of PWR	

(2) An example of connection for operation in source mode (common: P24)

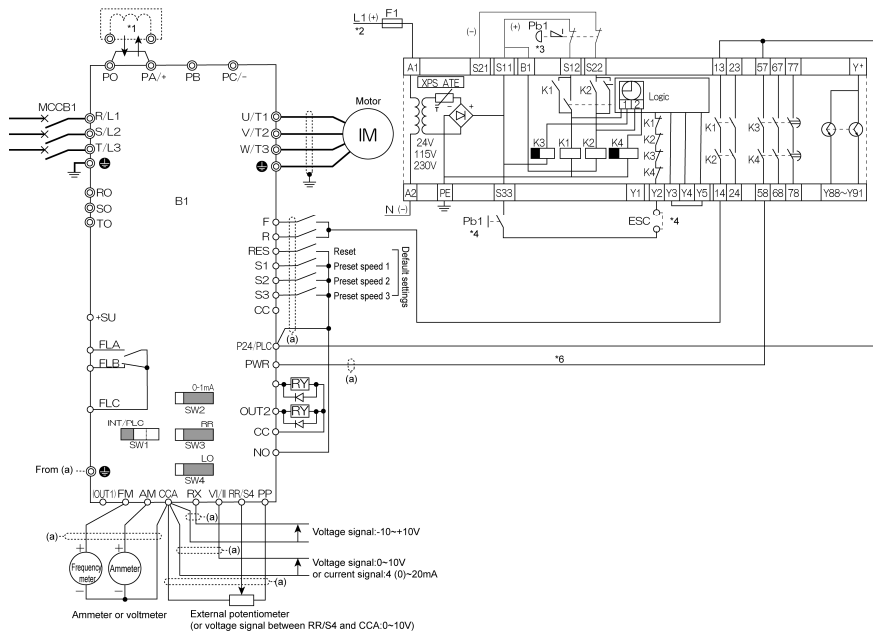

- In this connection, the PWR terminal is used to connect a safety device. The emergency stop circuit is supervised by the external safety relay. This safety relay can be shared among several inverters.
- In the event of an emergency stop, the external safety relay issues a deceleration command to the inverter. At this command, the motor slows down and stops. Then, the safety relay turns off the PWR terminal on expiration of the time limit (max. 30 sec) set for the relay. This operation falls under Stop Category 1 defined in IEC/EN60204-1.
- For this connection, the function of issuing the forward run command (2) needs to be assigned to the F terminal, and the function of issuing the reverse run command (4) to the R terminal.



Symbols	Description
B1	VF-PS1 inverter
MCCB1	Circuit breaker
B2	Safety relay: XPS-ATE (manufactured by Schneider Electric)
F1	Fuse
Pb1	Push button switch 2b contact (for emergency stop)
Pb2	Push button switch (for reset and start)

- *1: Some inverters* are shipped with the PO and PA/+ terminals short-circuited with a shorting bar. (* 200V/45kW class and lower and 400V/75kW class and lower)
- *2: Supply voltage: AC/DC24V, AC48V, AC115V, AC230V
- *3: If an emergency stop command is issued, the PWR terminal will be turned off to coast and stop the motor.
- *4: Pb2 is used to reset/start the inverter after the power is turned on or in the event of an emergency stop. ESC is used to set reset/start conditions for the external device.
- *5: If a deceleration time of more than 30 seconds is required, use a safety relay XPS-AV, which allows you to set the deceleration time at a maximum of 300 seconds.
- *6: To connect a safety relay to the PWR terminal, use a coaxial cable RG174/U (MIL-C17) or KX3B (NFC93-550) 2.54 mm or more in outside diameter and 2 m or less in length. When using a shielded cable, ground it.

10. Selection of peripheral devices

 Danger	
 Mandatory	<ul style="list-style-type: none"> • When using the inverter without the front cover, be sure to place the inverter unit inside a cabinet. If they are used outside the cabinet, it may cause electric shock.
 Be Grounded	<ul style="list-style-type: none"> • Be sure to ground every unit. If not, it may cause electric shock or fire on the occasion of failure, short-circuit or electric leak.

10.1 Selection of wiring materials and devices

Voltage class	Applicable motor [kW]	Inverter model	Wire size											
			Main circuit				DC terminal (optional)		Braking resistor/Braking unit (optional) (*4)		Earth cable			
			Input terminal (R, S, T)		Output terminal (U, V, W)		AWG	mm ²	AWG	mm ²	AWG	mm ²	AWG	mm ²
200V class	0.4	VFPS1-2004PL	14	1.5	14	1.5	14	1.5	14	1.5	14	1.5	14	2.5
	0.75	VFPS1-2007PL	14	1.5	14	1.5	14	1.5	14	1.5	14	1.5	14	2.5
	1.5	VFPS1-2015PL	14	1.5	14	1.5	12	1.5	14	1.5	14	1.5	14	2.5
	2.2	VFPS1-2022PL	12	1.5	12	1.5	10	2.5	14	1.5	14	1.5	14	2.5
	3.7	VFPS1-2037PL	10	4	10	4	8	6	14	1.5	12	4	10	16
	5.5	VFPS1-2055PL	8	6	8	6	6	10	14	1.5	10	6	10	16
	7.5	VFPS1-2075PL	8	10	8	10	4	16	12	2.5	10	10	10	16
	11	VFPS1-2110PM	4	16	4	16	3	16	10	4	10	16	16	16
	15	VFPS1-2150PM	4	25	4	25	1	25	8	6	10	16	16	16
	18.5	VFPS1-2185PM	3	25	3	25	1/0	35	8	10	8	16	16	16
	22	VFPS1-2220PM	2	25	2	25	2/0	35	6	16	8	16	16	16
	30	VFPS1-2300PM	2/0	50	2/0	50	4/0	70	4	25	6	25	16	25
	37	VFPS1-2370PM	3/0	70	3/0	70	250MCM	95	3	35	6	35	16	35
	45	VFPS1-2450PM	4/0	70	4/0	70	300MCM	95	2	50	6	35	16	35
	55	VFPS1-2550P	3/0×2	70×2	3/0×2	120	4/0×2	95×2	1/0	50	1/0	70	1/0	70
75	VFPS1-2750P	4/0×2	95×2	4/0×2	70×2	3/0×2	95×2	1/0	35×2	1/0	95	1/0	95	
90	VFPS1-2900P	250MCM×2	120×2	250MCM×2	95×2	300MCM×2	120×2	1/0	50×2	1/0	120	1/0	120	
400V class	0.75	VFPS1-4007PL	14	1.5	14	1.5	14	1.5	14	1.5	14	1.5	14	2.5
	1.5	VFPS1-4015PL	14	1.5	14	1.5	14	1.5	14	1.5	14	1.5	14	2.5
	2.2	VFPS1-4022PL	14	1.5	14	1.5	14	1.5	14	1.5	14	1.5	14	2.5
	3.7	VFPS1-4037PL	12	1.5	12	1.5	10	2.5	14	1.5	14	1.5	14	2.5
	5.5	VFPS1-4055PL	10	2.5	10	2.5	8	4	14	1.5	12	2.5	10	16
	7.5	VFPS1-4075PL	10	4	10	4	8	6	14	1.5	12	4	10	16
	11	VFPS1-4110PL	8	6	8	6	6	10	14	1.5	10	6	10	16
	15	VFPS1-4150PL	6	10	6	10	4	16	12	2.5	10	10	10	16
	18.5	VFPS1-4185PL	6	10	6	10	4	16	10	2.5	10	10	10	16
	22	VFPS1-4220PL	6	10	6	10	4	16	10	4	10	8	10	16
	30	VFPS1-4300PL	4	16	4	16	2	25	8	6	10	16	16	
	37	VFPS1-4370PL	3	25	3	25	1	35	8	10	8	16	16	
	45	VFPS1-4450PL	1	35	1	35	2/0	50	6	16	8	16	16	
	55	VFPS1-4550P	1/0	50	1/0	50	3/0	70	6	16	6	25	16	25
	75	VFPS1-4750PL	3/0	70	3/0	70	250MCM	95	3	35	6	35	16	35
	90	VFPS1-4900PC	1/0×2	70×2	1/0×2	95	1/0×2	95×2	1/0	35	2	70	1/0	70
	110	VFPS1-4110KPC	2/0×2	95×2	2/0×2	120	2/0×2	95×2	1/0	35	2	95	1/0	95
	132	VFPS1-4132KPC	4/0×2	95×2	4/0×2	70×2	4/0×2	120×2	1/0	50	1	95	1/0	95
	160	VFPS1-4160KPC	250MCM×2	120×2	250MCM×2	95×2	4/0×2	120×2	4/0	70	1	120	1/0	120
	220	VFPS1-4220KPC	350MCM×2	150×2	350MCM×2	150×2	350MCM×2	150×2	4/0	95	2/0	150	1/0	150
	250	VFPS1-4250KPC	250MCM×3	150×2	250MCM×3	150×2	4/0×3	185×2	300MCM	150	2/0	150	1/0	150
280	VFPS1-4280KPC	300MCM×3	150×3	300MCM×3	120×3	300MCM×3	150×3	300MCM	150	3/0	120×2	1/0	120×2	
315	VFPS1-4315KPC	350MCM×3	150×3	350MCM×3	150×3	350MCM×3	150×3	300MCM	150	3/0	120×2	1/0	120×2	
400	VFPS1-4400KPC	350MCM×4	150×4 (*6)	350MCM×4	120×4	500MCM×3	150×4 (*5)	300MCM×2	150×2	4/0	150×2	1/0	150×2	
500	VFPS1-4500KPC	500MCM ×2×2 (*7)	150×2×2 (*6)	500MCM×4	185×4	500MCM×4	185×4 (*5)	300MCM×2	150×2	250MCM	150×2	1/0	150×2	
630	VFPS1-4630KPC	500MCM ×3×2 (*7)	150×3×2 (*6)	500MCM×5	185×5	500MCM×4	185×4 (*5)	300MCM×2	150×2	350MCM	185×2	1/0	185×2	

(*1): The recommended cable size is that of the cable (e.g. 600V class, HIV cable) with continuous maximum permissible temperature of 75°C. The ambient temperature is assumed to be 50°C or below for 200V-45kW or less models and 400V-75kW or less models, or 50°C for 200V-55kW or more models and 400V-90kW or more models. (The interconnect cable length is assumed to be 30m or less.)

(*2): For the control circuit, use shielded wires whose size (cross-section) is 0.75 mm² or more.

(*3): For the earth cable, use wires larger than the specified ones in size (cross-section).

(*4): Recommended wire size for an optional braking resistor. Refer to 5.19 for use of external braking resistor.

(*5): The recommended cable is 600V class HIV cable with permissible temperature of 90°C.

(*6): The number refers to a cable composition. For example, in the case of "120×2×2":

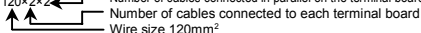

10

■ Selection of wiring equipment

Voltage class	Applicable motor [kW]	Inverter model	Input current[A]		No-fuse breaker (MCCB)		Magnetic contactor (MC)	
					Without Reactor	With Reactor	Without Reactor	With Reactor
			Without Reactor	With Reactor	Rated current [A]	Rated current [A]	Operation current [A] AC-1	Operation current [A] AC-1
200V class	0.4	VFPS1-2004PL	3.5	2.1	5	5	25	25
	0.75	VFPS1-2007PL	6.1	3.2	10	5	25	25
	1.5	VFPS1-2015PL	11.5	6.4	15	10	25	25
	2.2	VFPS1-2022PL	15	9.3	20	15	25	25
	3.7	VFPS1-2037PL	26.0	15.5	30	30	32	25
	5.5	VFPS1-2055PL	35	22.5	50	40	40	25
	7.5	VFPS1-2075PL	45	34.5	60	40	50	40
	11	VFPS1-2110PM	-	53.5	-	75	-	80
	15	VFPS1-2150PM	-	72	-	100	-	80
	18.5	VFPS1-2185PM	-	77	-	100	-	80
	22	VFPS1-2220PM	-	88	-	125	-	125
	30	VFPS1-2300PM	-	125	-	150	-	125
	37	VFPS1-2370PM	-	140	-	175	-	250
	45	VFPS1-2450PM	-	165	-	200	-	250
	55	VFPS1-2550P	-	200	-	250	-	275
75	VFPS1-2750P	-	270	-	350	-	350	
90	VFPS1-2900P	-	336	-	500	-	500	
400V class	0.75	VFPS1-4007PL	3.7	2.1	5	4	25	25
	1.5	VFPS1-4015PL	5.8	3.8	10	6.3	25	25
	2.2	VFPS1-4022PL	8.2	5.7	14	10	25	25
	3.7	VFPS1-4037PL	14.0	8.7	18	14	25	25
	5.5	VFPS1-4055PL	20.5	12.7	32	25	25	25
	7.5	VFPS1-4075PL	27	16.3	32	25	32	25
	11	VFPS1-4110PL	36.5	21.5	50	30	40	32
	15	VFPS1-4150PL	48	33.5	60	40	50	40
	18.5	VFPS1-4185PL	-	45.5	-	60	-	50
	22	VFPS1-4220PL	-	50	-	60	-	50
	30	VFPS1-4300PL	-	66	-	100	-	80
	37	VFPS1-4370PL	-	84	-	100	-	125
	45	VFPS1-4450PL	-	105	-	125	-	125
	55	VFPS1-4550PL	-	120	-	150	-	125
	75	VFPS1-4750PL	-	165	-	200	-	250
	90	VFPS1-4900PC	-	170	-	200	-	250
	110	VFPS1-4110KPC	-	200	-	250	-	275
	132	VFPS1-4132KPC	-	240	-	300	-	315
	160	VFPS1-4160KPC	-	290	-	350	-	350
	220	VFPS1-4220KPC	-	395	-	500	-	500
	250	VFPS1-4250KPC	-	444	-	700	-	700
280	VFPS1-4280KPC	-	495	-	700	-	700	
315	VFPS1-4315KPC	-	555	-	700	-	1000	
400	VFPS1-4400KPC	-	709	-	1000	-	1000	
500	VFPS1-4500KPC	-	876	-	1200	-	1600	
630	VFPS1-4630KPC	-	1091	-	1600	-	1600	

(*1): Selections for use of the Toshiba 4-pole standard motor with power supply voltage of 200V/400V-50Hz.

(*2): Choose the MCCB according to the power supply capacity.

For comply with UL and CSA standard, use the fuse certified by UL and CSA.

(*3): When using on the motor side during commercial-power supply operation, choose the MC with class AC-3 rated current for the motor rated current.

(*4): Attach surge killers to the magnetic contactor and exciting coil of the relay.

(*5): In the case the magnetic contactor (MC) with 2a-type auxiliary contacts is used for the control circuit, raise the reliability of the contact by using 2a-type contacts in parallel connection.

(*6): For 200V/55kW model and larger and 400V/90kW model and larger, be sure to install a DC reactor.

10.2 Installation of a magnetic contactor

If using the inverter without installing a magnetic contactor (MC) in the primary circuit, use an MCCB (with a power cutoff device) to open the primary circuit when the inverter protective circuit is activated.

If using a braking resistor or braking resistor unit, install a magnetic contactor (MC) or no-fuse breaker with a power cutoff device to the power supply of the inverter, so that the power circuit opens when the failure detection relay (FL) in the inverter or the external overload relay is activated.

■ Magnetic contactor in the primary circuit

To detach the inverter from the power supply in any of the following cases, insert a magnetic contactor (primary-side magnetic contactor) between the inverter and the power supply.

- (1) If the motor overload relay is tripped
- (2) If the protective detector (FL) built into the inverter is activated
- (3) In the event of a power failure (for prevention of auto-restart)
- (4) If the resistor protective relay is tripped when a braking resistor or braking resistor unit is used

When using the inverter with no magnetic contactor (MC) on the primary side, install a no-fuse breaker with a voltage tripping coil instead of an MC and adjust the no-fuse breaker so that it will be tripped if the protective relay referred to above is activated. To detect a power failure, use an undervoltage relay or the like.

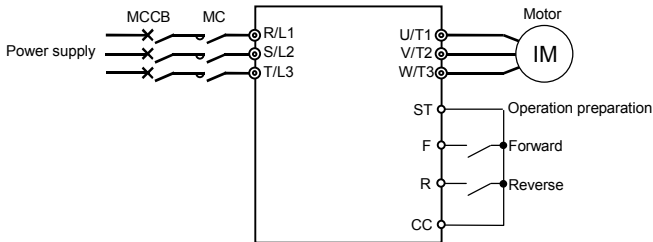

Example of connection of a magnetic contactor in the primary circuit

Note on wiring

- When frequently switching between start and stop, do not use the magnetic contactor on the primary side as an on-off switch for the inverter. Instead, stop and start the inverter by using terminals F and CC (forward run) or R and CC (reverse run).
- Be sure to attach a surge killer to the exciting coil of the magnetic contactor (MC).

■ Magnetic contactor in the secondary circuit

A magnetic contactor may be installed on the secondary side to switch controlled motors or supply commercial power to the load when the inverter is out of operation.

Note on wiring

- Be sure to interlock the magnetic contactor on the secondary side with the power supply to prevent commercial power from being applied to the inverter output terminals.
- When installing a magnetic contactor (MC) between the inverter and the motor, avoid turning the magnetic contactor on or off during operation. Turning the magnetic contactor on or off during operation causes a current to rush into the inverter which could lead to malfunction.

10.3 Installation of an overload relay

- 1) The VF-PS1 inverter has an electronic-thermal overload protective function. In the following cases, however, an overload relay suitable for the adjustment of the motor electronic thermal protection level ($I_H r$) or appropriate to the motor used should be installed between the inverter and the motor.
 - When using a motor with a current rating different to that of the corresponding Toshiba general-purpose motor
 - When operating a single motor with an output smaller than that of the applicable standard motor.
 When operating multiple motors at a time, be sure to install an overload relay for each individual motor.
- 2) When using the VF-PS1 inverter to operate a constant-torque motor, such as the Toshiba VF motor, adjust the protection characteristic of the electronic thermal protection unit ($I_L r$) to the VF motor use.
- 3) It is recommended to use a motor with a thermal relay embedded in the motor coil to give sufficient protection to the motor, especially when it runs in a low-speed range.

10.4 Application and functions of options

Separate type options shown below are prepared for the inverter VF-PS1

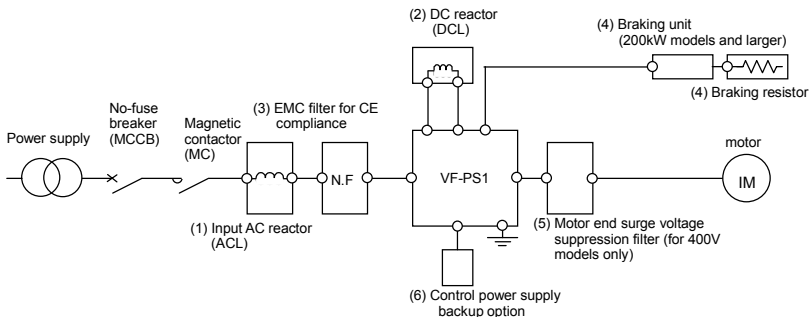

Sorts of separate-type options

No.	Option name	Function, purpose.																	
(1)	Input AC reactor (ACL)	<p>To be used for improvement of input power-factor of the inverter power source, for reducing higher harmonic or suppressing external surge. The input reactor can be installed when the power capacity is 500 kVA or more and it is 10 times or more as high as the inverter capacity or there are some source distorted wave generation such as a thyristor, etc. and a high capacity inverter connected with the same distribution system.</p> <table border="1"> <thead> <tr> <th rowspan="2">Type of reactor</th> <th rowspan="2">Power-factor improvement</th> <th colspan="2">Effect</th> <th rowspan="2">External surge suppression</th> </tr> <tr> <th>Harmonic suppression 200V, 3.7kW or less</th> <th>Other combination</th> </tr> </thead> <tbody> <tr> <td>Input AC reactor</td> <td>Effective</td> <td>Effective</td> <td>Effective</td> <td>Effective</td> </tr> <tr> <td>DC reactor</td> <td>Very effective</td> <td>Effective</td> <td>Very effective</td> <td>Not effective</td> </tr> </tbody> </table>	Type of reactor	Power-factor improvement	Effect		External surge suppression	Harmonic suppression 200V, 3.7kW or less	Other combination	Input AC reactor	Effective	Effective	Effective	Effective	DC reactor	Very effective	Effective	Very effective	Not effective
					Type of reactor	Power-factor improvement		Effect		External surge suppression									
Harmonic suppression 200V, 3.7kW or less	Other combination																		
Input AC reactor	Effective	Effective	Effective	Effective															
DC reactor	Very effective	Effective	Very effective	Not effective															
(2)	DC reactor(DCL)	<p>The DC reactor is superior to the input AC reactor in power-factor improvement. For the inverter system that is required to be high reliable, it is recommended to use the input AC reactor that effectually suppresses external surge together with the DC reactor. 200V/11 to 45kW models and 400V/18.5 to 75kW models come with a built-in DC reactor as standard equipment.</p> <p>* If you are using a 200V/55kW model or larger or a 400V/90kW model or larger, be sure to connect a DC reactor. (No DC reactor is required when the inverter is powered from a DC power supply.)</p>																	
(3)	EMC Directive compliant noise reduction filter (EMF3-*****)	<p>If EMC filter is installed in proper connection, the inverter has consistency with EMC commands. 200V/0.4kW to 200V/7.5kW models and 400V/0.75 to 400V/630kW models come standard with built-in noise filters. The effectiveness of the built-in filter can, however, be increased by adding an EMC filter.</p>																	
(4)	Braking resistor Braking unit	<p>To be used to shorten deceleration time for the reason of frequently operated quick deceleration and suspension or high inertia load. This increases consumption of regenerative energy in dynamic braking.</p> <p>For 250kW more inverter, it requires the braking unit.</p>																	
(5)	Motor end surge voltage suppression filter (for 400 V models only)	<p>In a system in which 400 V class general motor is driven by a voltage PWM type inverter using a high-speed switching device (IGBT, etc.), surge voltage depending on cable constant may cause deterioration in insulation of motor winding. Take measures against surge voltage such as use of insulation-reinforced motor, installation of AC reactor, surge voltage suppression filter, sine wave filter and so on in the inverter's output side.</p> <p>Note) Set the carrier frequency to 4.0~8.0kHz or larger when sine wave filter is used.</p>																	
(6)	Control power supply backup option	<p>The VF-PS1 supplies control power from the main circuit power supply in it. The optional backup unit is designed to supply control power in the event the main circuit power supply shuts down.</p> <p>The optional backup unit can be used with both 200V and 400V models.</p>																	

10

No.	Option name	Function, purpose.
(7)	LED Remote Keypad option (with parameter copy function)	Extention operation panel unit with parameter copy function. Includes LED display, RUN/STOP key, UP/DOWN key, MODE key, ENT key, EASY key, and COPY MODE key. (When using this unit, set as follows: $F \text{ B } \text{ B } \text{ S}$ (common serial transmission waiting time) = $\text{B}.\text{B}.\text{B}$ (default setting). Use communication cable No. 13 to connect to the inverter. Panel type: RKP002Z Cable type: CAB0011, CAB0011 (1m), CAB0013 (3m), CAB0015 (5m)
(8)	LCD Remote Keypad option	This LCD operation panel unit can be installed to the inverter unit. Includes LCD display, RUN key, STOP/RESET key, job dial, ESC key, FWD/REV key and F1 to F4 key. Special cable is needed to connect the inverter and LCD panel. Panel type: RKP004Z LCD cable type: CAB0071 (1m), CAB0073 (3m), CAB0075 (5m), CAB00710 (10m)
(9)	RS485/USB communication converter unit (for communication with multiple inverters)	More than one inverter can be controlled with a personal computer and so on if this unit is used for connection between inverters and personal computer. <ul style="list-style-type: none"> • Computer link: Since this unit makes it possible to connect inverters with higher-class computer, FA computer, etc., a data communication network can be constructed among multiple inverters. • Communication among inverters: For the purpose of proportional operation of multiple inverters, a frequency data communication network can be constructed among multiple inverters. Unit type: USB001Z
(10)	Communication cable	For RS485/USB communication (between inverter and RS485/USB communication conversion unit) Cable type: CAB0011 (1m), CAB0013 (3m), CAB0015 (5m)
(11)	Operation panel	A frequency meter, frequency setup device, RUN/STOP (forward, reverse) switch are built in this operation panel. (Model: CBVR-7B1)

Selection table of separate-type options (1/2)

Voltage class	Applicable motor [kW]	Inverter model	EMC filter (*1)	DC reactor (DCL)	Dynamic brake drive circuit (GTR7) (*2)	Control power supply backup
200V class	0.4	VFPS1-2004PL	Built-in	Option	Built-in	Option
	0.75	VFPS1-2007PL	Built-in	Option	Built-in	Option
	1.5	VFPS1-2015PL	Built-in	Option	Built-in	Option
	2.2	VFPS1-2022PL	Built-in	Option	Built-in	Option
	3.7	VFPS1-2037PL	Built-in	Option	Built-in	Option
	5.5	VFPS1-2055PL	Built-in	Option	Built-in	Option
	7.5	VFPS1-2075PL	Built-in	Option	Built-in	Option
	11	VFPS1-2110PM	Option	Built-in	Built-in	Option
	15	VFPS1-2150PM	Option	Built-in	Built-in	Option
	18.5	VFPS1-2185PM	Option	Built-in	Built-in	Option
	22	VFPS1-2220PM	Option	Built-in	Built-in	Option
	30	VFPS1-2300PM	Option	Built-in	Built-in	Option
	37	VFPS1-2370PM	Option	Built-in	Built-in	Option
	45	VFPS1-2450PM	Option	Built-in	Built-in	Option
	55	VFPS1-2550P	Option	Attached as standard	Built-in	Option
75	VFPS1-2750P	Option	Attached as standard	Built-in	Option	
90	VFPS1-2900P	Option	Attached as standard	Built-in	Option	
400V class	0.75	VFPS1-4007PL	Built-in	Option	Built-in	Option
	1.5	VFPS1-4015PL	Built-in	Option	Built-in	Option
	2.2	VFPS1-4022PL	Built-in	Option	Built-in	Option
	3.7	VFPS1-4037PL	Built-in	Option	Built-in	Option
	5.5	VFPS1-4055PL	Built-in	Option	Built-in	Option
	7.5	VFPS1-4075PL	Built-in	Option	Built-in	Option
	11	VFPS1-4110PL	Built-in	Option	Built-in	Option
	15	VFPS1-4150PL	Built-in	Option	Built-in	Option
	18.5	VFPS1-4185PL	Built-in	Built-in	Built-in	Option
	22	VFPS1-4220PL	Built-in	Built-in	Built-in	Option
	30	VFPS1-4300PL	Built-in	Built-in	Built-in	Option
	37	VFPS1-4370PL	Built-in	Built-in	Built-in	Option
	45	VFPS1-4450PL	Built-in	Built-in	Built-in	Option
	55	VFPS1-4550PL	Built-in	Built-in	Built-in	Option
	75	VFPS1-4750PL	Built-in	Built-in	Built-in	Option
	90	VFPS1-4900PC	Built-in	Attached as standard	Built-in	Option
	110	VFPS1-4110KPC	Built-in	Attached as standard	Built-in	Option
	132	VFPS1-4132KPC	Built-in	Attached as standard	Built-in	Option
160	VFPS1-4160KPC	Built-in	Attached as standard	Built-in	Option	
220	VFPS1-4220KPC	Built-in	Attached as standard	Built-in	Option	
250	VFPS1-4250KPC	Built-in	Attached as standard	Option	Option	
280	VFPS1-4280KPC	Built-in	Attached as standard	Option	Option	
315	VFPS1-4315KPC	Built-in	Attached as standard	Option	Option	
400	VFPS1-4400KPC	Built-in	Attached as standard	Option	Option	
500	VFPS1-4500KPC	Built-in	Attached as standard	Option	Option	
630	VFPS1-4630KPC	Built-in	Attached as standard	Option	Option	

(*1): For the types and effects of EMC filters, refer to section 9.1.

(*2): An optional braking resistor is required for every model of any capacity (see Selection table of separate-type options (2/2)).

10

Selection table of separate-type options (2/2)

Voltage class	Appli-cable motor [kW]	Inverter model	Input AC reactor (ACL)	DC reactor (DCL) (*6)	EMC Diredctive compliant noise reduction filter	Braking resistor (*1)	Motor end surge voltage suppression filter (*4)	Control power supply backup			
200V class	0.4	VFPS1-2004PL	PFL-2005S	DCL-2007	Built in	PBR-2007	-				
	0.75	VFPS1-2007PL									
	1.5	VFPS1-2015PL	PFL-2011S	DCL-2022							
	2.2	VFPS1-2022PL	PFL-2018S	DCL-2037							
	3.7	VFPS1-2037PL									
	5.5	VFPS1-2055PL	PFL-2025S	DCL-2055							
	7.5	VFPS1-2075PL	PFL-2050S	DCL-2110							
	11	VFPS1-2110PM									
	15	VFPS1-2150PM	PFL-2100S	Built in					EMF3-4074E	PBR3-2150	
	18.5	VFPS1-2185PM							EMF3-4090F	PBR3-2220	
	22	VFPS1-2220PM							EMF3-4180H	PBR-222W002	
	30	VFPS1-2300PM								PFL-2150S	PBR-222W002
	37	VFPS1-2370PM							Attached as standard		EMF3-4300I
	45	VFPS1-2450PM								EMF3-4600J	
55	VFPS1-2550P	PFL-2300S									
75	VFPS1-2750P	PFL-2400S									
90	VFPS1-2900P	PFL-2600S									
400V class	0.75	VFPS1-4007PL	PFL-4012S	DCL-2007 (*5)	Built in	PBR-2007	MSF-4015Z				
	1.5	VFPS1-4015PL		DCL-2022 (*5)							
	2.2	VFPS1-4022PL	PFL-4025S	DCL-4110				PBR-4037	MSF-4037Z		
	3.7	VFPS1-4037PL						PBR3-4055	MSF-4075Z		
	5.5	VFPS1-4055PL	PFL-4100S	DCL-4220				PBR3-4075	MSF-4150Z		
	7.5	VFPS1-4075PL						PBR3-4110	MSF-4150Z		
	11	VFPS1-4110PL	PFL-4050S	Built in				PBR3-4150	MSF-4220Z		
	15	VFPS1-4150PL						PBR3-4220	MSF-4370Z		
	18.5	VFPS1-4185PL	PFL-4100S	Attached as standard				PBR-417W008	MSF-4550Z		
	22	VFPS1-4220PL							MSF-4750Z		
	30	VFPS1-4300PL	PFL-4150S	PFL-4300S				DGP600W-B2 [DGP600W-C2]	MSL-4215T		
	37	VFPS1-4370PL							PFL-4400S	DGP600W-B3 [DGP600W-C3]	MSL-4314T
	45	VFPS1-4450PL	PFL-4150S	PFL-4600S				DGP600W-B4 [DGP600W-C4]		MSL-4759T	
	55	VFPS1-4550PL							PB7-4200K(*2)		MSL-41188T
	75	VFPS1-4750PL	PFL-4150S	PFL-4800S				DGP600W-B4 [DGP600W-C4]			
	90	VFPS1-4900PC						PFL-4300S	PFL-4400S	PB7-4400K(*2)	
	110	VFPS1-4110KPC	PFL-4300S	PFL-4400S						DGP600W-B3	
	132	VFPS1-4132KPC						PFL-4400S	PFL-4400S	DGP600W-B4	
	160	VFPS1-4160KPC	PFL-4400S	PFL-4400S						DGP600W-C3	
	220	VFPS1-4220KPC						PFL-4600S	PFL-4600S	PB7-4200K(*2)	
	250	VFPS1-4250KPC	PFL-4280KPC	PFL-4800S						DGP600W-B4	
	280	VFPS1-4280KPC						PFL-4315KPC	PFL-4800S	DGP600W-C3	
315	VFPS1-4315KPC	PFL-4800S	PFL-4800S	DGP600W-C4							
400	VFPS1-4400KPC			PFL-4450S ×2(parallel)	PFL-4800S	PB7-4400K(*2)					
500	VFPS1-4500KPC	PFL-4613S ×2(parallel)	PFL-4800S			DGP600W-B4					
630	VFPS1-4630KPC			PFL-4613S ×2(parallel)	PFL-4800S	DGP600W-C4					

CPS002Z

10

(*1): Model in square brackets is fitted with top cover.

(*2): To use a 400V/250kW inverter or larger in combination with an external braking resistor (DGP600 series), a braking unit (PB7) with a built-in braking resistor drive circuit is also needed.

(*3): The options are selected based on the premise that 600V HIV insulated wires (continuous allowable temperature: 75°C) are used.

(*4): Each MSF-****Z model is composed of a reactor, a resistor and a capacitor, and as a guide, use a cable 300m or less in length to connect the inverter to the motor.

Each MSL-****T model is an output-dedicated surge suppression reactor, and as a guide, use a cable 100m or less in length (or 50m or less for a shielded cable) to connect the inverter to the motor, although allowable cable lengths vary according to the input voltage.)

(*5): These reactors are usable for each of 200V class and 400V class.

(*6): Be sure to connect DC reactor to 200V-55kW or more or 400V-90kW or more inverter. (Not necessary for DC power input.)

When a 200V-55kW or more inverter or 400V-90 to 280kW inverter is replaced with new one, the reactor (model: DCL-****) used with the current inverter can be used as-is with the new inverter. In such cases, therefore, you do not need to purchase any reactors in this table.

10.5 Optional internal devices

Here are the internal devices optionally available. There are two types of optional devices: Add-on type and Plug-in type.

■ Table of optional devices

Option name		Function, purpose	Model	Type of installation
Expansion terminal function	(1) Expansion I/O card1 (Logic input/output + PTC input)	Used to extend input and output terminals.	ETB003Z	Add-on
	(2) Expansion I/O card2 (Function of the above optional card 1 + Analogue input/output + Pulse input)		ETB004Z	Add-on
Communication function	(3) CC-Link communication card	Used to connect to a CC-Link network for control.	CCL001Z	Add-on
	(4) DeviceNet communication card	Used to connect to a DeviceNet network for control.	DEV002Z	Add-on
	(5) PROFIBUS-DP communication card	Used to connect to a PROFIBUS-DP network for control.	PDP002Z	Add-on
	(6) LonWorks communication card	Used to connect to a LonWorks network for control.	LIU006Z	Add-on
	(7) BAC net communication card	Used to connect to a BAC net network for control.	BCN001Z	Add-on
	(8) Metasys N2 communication card	Used to connect to a Metasys N2 network for control.	MTS001Z	Add-on
	(9) APOGEE FLN communication card	Used to connect to a APOGEE FLN network for control.	APG001Z	Add-on
Other function	(10) PG feedback (Push-pull 12V)	Used to issue motor pulse train rate commands or used for sensor vector control.	VEC004Z	Plug-in
	(11) PG feedback (Push-pull 15V)		VEC005Z	Plug-in
	(12) PG feedback (RS422-5V)		VEC007Z	Plug-in

■ Functions of Add-on type options

(1) Expansion I/O card1 (Logic input/output + PTC input)

Function	Description
Multifunction programmable contact input (4 points)	No-voltage contact input (24Vdc-5mA or less) Sink logic input (at a common voltage of 24V) ON: Less than 10Vdc OFF: 16Vdc or more Source logic input ON: 11Vdc or more OFF: Less than 5Vdc
Multifunction programmable open collector output (2 points)	Driving current: Max. 50mA when an external power source is used Max. 20mA when the internal power source is used Driving voltage: 12V (min) to 30V (max)
Multifunction programmable relay contact output	1C contact configuration 250Vac-2A (cosφ=1), 250Vac-1A (cosφ=0.4), 30Vdc-1A
External thermal trip input	Resistance between TH+ and TH- Error: Approx. 70Ω or less or approx. 3kΩ or more Recovery from error: Approx. 1.6kΩ
24V power output	24Vdc - 60mA max
-10V power output	-10Vdc -10mA
Contact input common terminal	Common terminals for contact input

(2) Expansion I/O card2 (Function of optional card 1 + Analogue input/output + Pulse input)

Function	Description
Multifunction programmable contact input (4 points)	No-voltage contact input (24Vdc-5mA or less) Sink logic input (at a common voltage of 24V) ON: Less than 10Vdc OFF: 16Vdc or more Source logic input ON: 11Vdc or more OFF: Less than 5Vdc
Multifunction programmable open collector output (2 points)	Driving current: Max. 50mA when an external power source is used Max. 20mA when the internal power source is used Driving voltage: 12V (min) to 30V (max)
Multifunction programmable relay contact output	1C contact configuration 250Vac-2A (cos ϕ =1), 250Vac-1A (cos ϕ =0.4), 30Vdc-1A
Differential current input	Current input: 20mA or less Voltage input: Differential voltages 5V or less, -10V or more, +10V or less
Analog input	Current input: 20mA or less Voltage input: 0V to 10V
Monitor output	Voltage output: -10V to 10V, 0V to 10V Current output: 0mA to 20mA
Pulse train input	Input pulse specifications Voltage: Max. 5V Current: Max. 15mA Frequency: Max. 30kHz Duty: 50 \pm 10%
External thermal trip input	Resistance between TH+ and TH- Error: Approx. 70 Ω or less or approx. 3k Ω or more Recovery from error: Approx. 1.6k Ω
24V power output	24Vdc - 60mA max
-10V power output	-10Vdc -10mA
Contact input common terminal	Common terminals for contact input

■ Functions of Plug-in type options

	PG feedback (10) (11)	PG feedback (12)
Model	VEC004Z, VEC005Z	VEC007Z
Sensor vector control operation	Speed control operation: Zero-speed - 120% torque Speed control range: 1:1000 (1000ppr PG)	
PG method	Complementary method, open collector method	Line drive method
PG cable length	Max. 100m (complementary method)	Max. 30m
PG supply power	VEC004Z: 12V-160mA VEC005Z: 15V-150mA	5V-160mA
Maximum pulse input frequency	300kHz or less * If a two-phase open collector is used, a study needs to be made to determine the derating factor. For details, refer to the operating manual for the optional device. Pulse duty: 50 \pm 10%	
Pulse input voltage	12Vdc~24Vdc	Line driver (LTC485 or equivalent)
Recommended encoder	Manufacturer: Sumtak Corporation Model: IRS360 series Supply voltage: 10.8 to 26.4V Output method: Complementary output	Manufacturer: Sumtak Corporation Model: IRS320 series Supply voltage: 5V Output method: Line driver method
Wiring of encoder	Cable type: Twisted-pair shielded cable Conductor resistance: Conductor resistance (Ω /m) x cable length (m) x 2 x current consumption (A) < V _D (V) V _D (V): 1.0V (VEC004Z, VEC005Z), 0.3V (VEC007Z) Applicable cable: 0.2 to 0.75mm ² * When a power cable 0.2 mm ² in cross sectional area is used, the encoder cable length should be: Max. 30m (VEC004Z, VEC005Z or Max. 10m (VEC007Z) Recommended cable: Kuramo Electric KVC-36SB, Furukawa Electric ROVV-SB	

How to install

Add-on type devices and insertion type devices are installed in different ways. Install them correctly, as shown in the figures below.

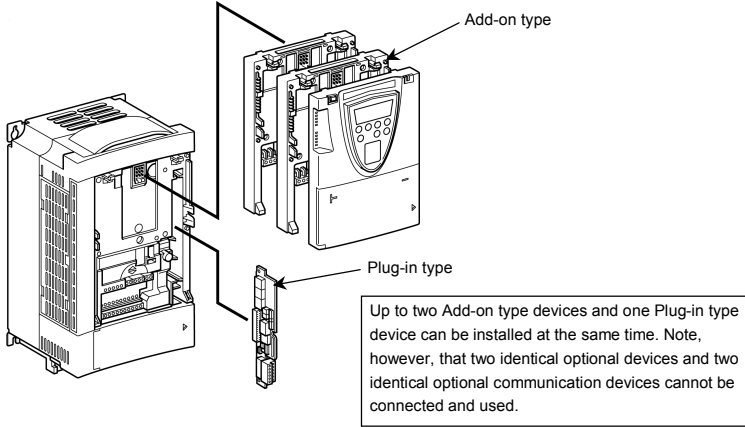

Depending on the capacity, the installation of an Add-on type device may increase the depth of the inverter.

200V 0.4~45kW
400V 0.75~37kW

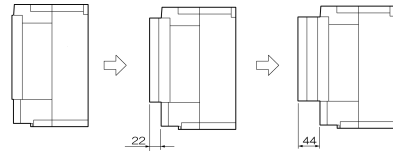

400V 45~75kW

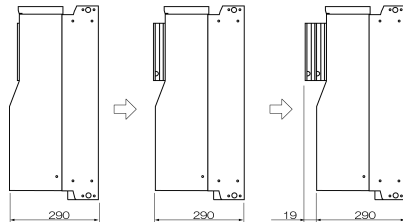

200V 55~90kW
400V 90~630kW

Note: The inverters of these capacities come equipped with an Add-on type option case as standard. When installing an optional Add-on type device, remove the case.

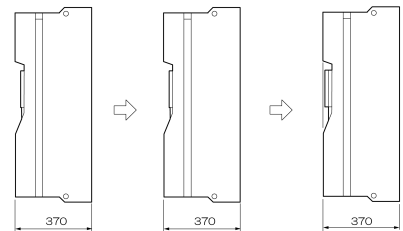

Standard type Standard type + one Add-on Standard type + two Add-on

10.6 Connection of a DC power supply and other electric units

Besides a three-phase commercial power supply, a single-phase 200V power supply (5.5kW or less) and a DC power supply can be connected to the VFPS1 inverter.

When connecting each of these units, keep in mind the points described in the following sections.

10.6.1 Connection of a single-phase 200V power supply

The table below shows which model to select when operating a three-phase induction motor, using a single-phase 200V power supply (200-240V, 50/60Hz).

Input power	Applicable motor (kW)	Inverter type
Single phase 200~240V 50/60Hz	0.4	VFPS1-2007PL
	0.75	VFPS1-2015PL
	1.5	VFPS1-2022PL
	2.2	VFPS1-2037PL
	3.7	VFPS1-2055PL
	5.5	VFPS1-2075PL

Note: Set the parameter $F508$ to 0 (input phase failure detection mode selection: disabled).

10.6.2 When using the inverter along with a DC power supply

Keep the following in mind when connecting a DC power supply to the VFPS1 (PA/+ and PC/- terminals).

Note 1: An optional initial charger (MCR-2550) is needed for middle- and large-capacity models.

Note 2: An inverter cooling fan is needed for large-capacity models.

Note 3: A DC reactor does not need to be connected to the inverter.

⇒ For details about use in combination with a DC power supply, refer to the instruction manual (E6581432) specified in section 6.36.

Voltage class	Inverter model	Initial charger (optional)	Change to connection of cooling fan power supply	DC reactor
200V class	VFPS1-2004PL~ VFPS1-2150PM	No required	No required	No required
	VFPS1-2185PM~ VFPS1-2550P	MCR-2550×1	No required	No required
	VFPS1-2750P, VFPS1-2900P	MCR-2550×2 (parallel)	Required	No required
400V class	VFPS1-4007PL~ VFPS1-4185PL	No required	No required	No required
	VFPS1-4220PL~ VFPS1-4110KPC	MCR-2550×1	No required	No required
	VFPS1-4132KPC ~ VFPS1-4220KPC	MCR-2550×2 (parallel)	Required	No required
	VFPS1-4250KPC~ VFPS1-4315KPC	MCR-2550×3 (parallel)	Required	No required
	VFPS1-4400KPC	MCR-2550×4 (parallel)	Required	No required
	VFPS1-4500KPC	MCR-2550×5 (parallel)	Required	No required
	VFPS1-4630KPC	MCR-2550×6 (parallel)	Required	No required

Note: Set the parameter $F508$ to 0 (input phase failure detection mode selection: disabled).

11. Table of parameters

1. Basic parameter [1/4]

Sensorless vector/vector with sensor (:Effective, -:Ineffective)										
Title	Communication No.	Function	Adjustment range	Minimum setting unit (Panel/Communication)	Default setting	Write during running	Vector control	PM control	V/f	Reference
<i>R U H</i>	-	History function		1/1	-	-	●/●	●	●	5. 1
<i>R U I</i>	0000	Automatic acceleration/deceleration	0:Disabled 1:Automatic setting 2:Automatic setting (during acceleration only)	1/1	0	Disabled	●/●	●	●	5. 2
<i>R U Z</i>	0001	Automatic torque boost	0:Disabled 1:Automatic torque boost + auto-tuning 1 2:Sensorless vector control + auto-tuning 1	1/1	0	Disabled	●/●	●	●	5. 3
<i>R U Y</i>	0040	Automatic function setting	0:Disabled 1:Frequency setting by means of voltage 2:Frequency setting by means of current 3:Voltage/current switching from external terminal 4:Frequency setting on operation panel and operation by means of terminals 5:Frequency setting and operation on operation panel 6:Coast stop	1/1	0	Disabled	●/●	●	●	5. 4
<i>C N D</i>	0003	Command mode selection	0:Terminal input enabled 1:Operation panel input enabled (including LED/LCD option input) 2:2-wire RS485 communication input 3:4-wireRS485 communication input 4:Communication option input	1/1	0	Disabled	●/●	●	●	5. 5
<i>F N D</i>	0004	Frequency setting mode selection 1	1:VIII (voltage/current input) 2:RR/S4 (potentiometer/voltage input) 3:RX (voltage input) 4:Operation panel input enabled (including LED/LCD option input) 5:2-wire RS485 communication input 6:4-wire RS485 communication input 7:Communication option input 8:Optional AI1 (differential current input) 9:Optional AI2 (voltage/current input) 10:UP/DOWN frequency 11:Optional RP pulse input 12:Optional high-speed pulse input	1/1	2	Disabled	●/●	●	●	5. 5

1. Basic parameter [2/4] Sensorless vector/vector with sensor (: Effective, -: Ineffective, -: Ineffective)

Title	Communi- cation No.	Function	Adjustment range	Minimum setting unit (Panel/Communi- cation)	Default setting	Write during running	Vector control	PM control	V/f	Reference											
P L	0015	V/f control mode selection	0: Constant torque characteristics 1: Voltage decrease curve 2: Automatic torque boost 3: Sensorless vector control 1 (speed) 4: - 5: V/f 5-point setting 6: PM control 7: PG feedback control 8: - 9: Energy-saving 10: Advanced energy-saving	1/1	0	Disabled	-	-	-	-	5.6										
			u b									0016	Manual torque boost 1	0.0~30.0%	*1	Enabled	-	•	•	5.7	
			u L									0014	Base frequency 1	25.0~500.0Hz	*3	Disabled	•/•	•	•	5.8	
			u L u									0409	Base frequency voltage 1	200V class: 50~330V 400V class: 50~660V	1/0.1	*1	Disabled	•/•	•	•	5.8
			F H									0011	Maximum frequency	30.0~500.0Hz	0.1/0.01	80.0	Disabled	•/•	•	•	5.9
			U L									0012	Upper limit frequency	0.0~F H Hz	0.1/0.01	*3	Enabled	•/•	•	•	5.10
			L L									0013	Lower limit frequency	0.0~U L Hz	0.1/0.01	0.0	Enabled	•/•	•	•	5.10
			d F L									0009	Acceleration time 1	0.1~6000 sec.	0.1/0.1 *2	*1	Enabled	•/•	•	•	5.2
			R u F L									0213	RRS4 input point 2 frequency	0.1~6000 sec.	0.1/0.1 *2	*1	Enabled	•/•	•	•	5.2
			R i F L									0204	Vf/II input point 2 frequency	0.0~F H Hz	0.1/0.01	*3	Enabled	•/•	•	•	5.11
5 r 1	0018	Preset speed operation frequency 1	L L ~U L Hz	0.1/0.01	0.0	Enabled	•/•	•	•	5.12											
5 r 2	0019	Preset speed operation frequency 2	L L ~U L Hz	0.1/0.01	0.0	Enabled	•/•	•	•	5.12											
5 r 3	0020	Preset speed operation frequency 3	L L ~U L Hz	0.1/0.01	0.0	Enabled	•/•	•	•	5.12											
5 r 4	0021	Preset speed operation frequency 4	L L ~U L Hz	0.1/0.01	0.0	Enabled	•/•	•	•	5.12											
5 r 5	0022	Preset speed operation frequency 5	L L ~U L Hz	0.1/0.01	0.0	Enabled	•/•	•	•	5.12											
5 r 6	0023	Preset speed operation frequency 6	L L ~U L Hz	0.1/0.01	0.0	Enabled	•/•	•	•	5.12											
5 r 7	0024	Preset speed operation frequency 7	L L ~U L Hz	0.1/0.01	0.0	Enabled	•/•	•	•	5.12											
F r	0008	Forward run/reverse run selection (operation panel operation)	0: Forward run 1: Reverse run 2: Forward run (Forward/reverse switchable on operation panel) 3: Reverse run (Forward/reverse switchable on operation panel)	1/1	0	Enabled	•/•	•	•	•	5.13										

*1: Default values vary depending on the capacity. → See the table of K-41.

*2: Changing the parameter L u P enables to set to 0.01 sec. (adjustment range: 0.01~600.0 sec.)

*3: Inverter with a model number ending with -WN: 60.0 -WP: 50.0

1. Basic parameter [3/4] Sensorless vector/vector with sensor (.:Effective, -:Ineffective, -:Ineffective)

Title	Communi- cation No.	Function	Adjustment range				Minimum setting unit (Panel/Communi- cation)	Default setting	Write during running	Vector control	PM control	V/f	Reference	
			Setting	Motor type	Overload protection	OL stall								
Motor electronic thermal protection level 1	0600		10~100%				1/1	100	Enabled	●/●	●	●	5. 14	
			Setting	Motor type	Overload protection	OL stall								
			0	Standard	○ (protect)	x (not stall)								
			1	Motor	x (not protect)	x (not stall)								
			2		x (not protect)	x (not stall)								
			3		x (not protect)	x (not stall)								
			4	VF Motor	○ (protect)	○ (stall)								
			5		x (not protect)	x (not stall)								
6		x (not protect)	x (not stall)											
7		x (not protect)	○ (stall)											
0%														
1:A (ampere)/V (volt)														
0~64 *1														
-														
0~64 *1														
-														
1.0~16.0kHz (2.5~8.0kHz) *2														
0:Disabled														
1:At auto-restart after momentary stop														
2:When turning ST on or off														
3:1+2														
4:At start-up														
0:Disabled														
1:Power ride-through														
2:Deceleration stop during power failure														
0:Deselect														
1:Enabled (braking resistance overload detect)														
2:Enabled (braking resistance overload not detect)														
0.5~1000Ω														
0.01~600.0kW														
1: → For the adjustment range, see the table on page K-34.														
*2: For 200V-55kW to 200V-90kW models and 400V-90kW to 400V-630kW models, the carrier frequency is between 2.5 and 8.0kHz inclusive.														
*3: Default values vary depending on the capacity. → See the table of K-41.														
*4: Default setting value is adjusted for connection of frequency meters "QS60T". (Between FM and CCA: Approx. 3.6V) (Between AM and CCA: Approx. 3.6V)														



1. Basic parameter [4/4] Sensorless vector/vector with sensor (:Effective, -:Ineffective)

Title	Communication No.	Function	Adjustment range	Minimum setting unit (Panel/Communication)	Default setting	Write during running	Vector control	PM control	V/f	Reference
<i>4-5P</i>	0007	Factory default setting	0: - 1: 50 Hz default setting 2: 60 Hz default setting 3: Factory default setting 4: Trip clear 5: Cumulative operation time cleared 6: Initialization of type information 7: Save user-defined parameters 8: Reset of user-defined parameters 9: Cumulative fan operation time record clear 10: Acceleration/deceleration time setting 0.01 sec. ~600.0 sec. 11: Acceleration/deceleration time setting 0.1 sec. ~6000sec.	1/1	0	Disabled	●/●	●	●	5.20
<i>P5EL</i>	0050	Registered parameter display selection	0: Standard setting mode at time of activation of motor 1: Quick mode at time of activation of motor 2: Quick mode only	1/1	0	Enabled	●/●	●	●	5.22
<i>F1--</i>	-	Extended parameters	Set detailed parameters shown in the following pages.	-	-	-	●/●	●	●	-
<i>Fg--</i>	-	Automatic edit function	-	-	-	-	●/●	●	●	4.2

2. Extended parameters

[1] Frequency signal

Sensorless vector/vector with sensor (:Effective, -:Ineffective, -:Ineffective)										
Title	Communication No.	Function	Adjustment range	Minimum setting unit (Panel/Communication)	Default setting	Write during running	Vector control	PM control	V/f	Reference
F 100	0100	Low-speed signal output frequency	0.0~UL Hz	0.1/0.01	0.0	Enabled	●/●	●	●	6. 1. 1
F 101	0101	Speed reach setting frequency	0.0~UL Hz	0.1/0.01	0.0	Enabled	●/●	●	●	6. 1. 2
F 102	0102	Speed reach detection band	0.0~UL Hz	0.1/0.01	2.5	Enabled	●/●	●	●	6. 1. 2

[2] Input signal selection

Sensorless vector/vector with sensor (:Effective, -:Ineffective)										
Title	Communication No.	Function	Adjustment range	Minimum setting unit (Panel/Communication)	Default setting	Write during running	Vector control	PM control	V/f	Reference
F 105	0105	Priority when forward/reverse run commands are entered simultaneously	0:Reverse run 1:Stop	1/1	1	Disabled	●/●	●	●	6. 2. 1
F 106	0106	Input terminal priority selection	0:Disabled 1:Enabled	1/1	0	Disabled	●/●	●	●	6. 2. 2
F 108	0108	Analog V1/V1 voltage/current switching	0:Voltage input 1:Current input	1/1	0	Disabled	●/●	●	●	6. 2. 3
F 109	0109	Analog AI2 (optional circuit board) voltage/current switching	0:Voltage input 1:Current input	1/1	0	Disabled	●/●	●	●	6. 2. 3

11

3) Terminal function selection

Sensorless vector/vector with sensor (:Effective, -:Ineffective, -:Ineffective)

Title	Communi- cation No.	Function	Adjustment range	Minimum setting unit (Panel/Communi- cation)	Default setting	Write during turning	Vector control	PM control	V/f	Reference
F110	0110	Always ON function selection 1	0~135 *1	1/1	6	Disabled	●/●	●	●	6.3.1
F111	0111	Input terminal function selection 1 (F)	0~135 *1	1/1	2	Disabled	●/●	●	●	7.2.1
F112	0112	Input terminal function selection 2 (R)	0~135 *1	1/1	4	Disabled	●/●	●	●	7.2.1
F114	0114	Input terminal function selection 4 (RES)	0~135 *1	1/1	8	Disabled	●/●	●	●	7.2.1
F115	0115	Input terminal function selection 5 (S1)	0~135 *1	1/1	10	Disabled	●/●	●	●	7.2.1
F116	0116	Input terminal function selection 6 (S2)	0~135 *1	1/1	12	Disabled	●/●	●	●	7.2.1
F117	0117	Input terminal function selection 7 (S3)	0~135 *1	1/1	14	Disabled	●/●	●	●	7.2.1
F118	0118	Input terminal function selection 8 (RR/S4)	0~135 *1	1/1	16	Disabled	●/●	●	●	7.2.1
F119	0119	Input terminal function selection 9 (L1)	0~135 *1	1/1	0	Disabled	●/●	●	●	7.2.1
F120	0120	Input terminal function selection 10 (L2)	0~135 *1	1/1	0	Disabled	●/●	●	●	7.2.1
F121	0121	Input terminal function selection 11 (L3)	0~135 *1	1/1	0	Disabled	●/●	●	●	7.2.1
F122	0122	Input terminal function selection 12 (L4)	0~135 *1	1/1	0	Disabled	●/●	●	●	7.2.1
F123	0123	Input terminal function selection 13 (L5)	0~135 *1	1/1	0	Disabled	●/●	●	●	7.2.1
F124	0124	Input terminal function selection 14 (L6)	0~135 *1	1/1	0	Disabled	●/●	●	●	7.2.1
F125	0125	Input terminal function selection 15 (L7)	0~135 *1	1/1	0	Disabled	●/●	●	●	7.2.1
F126	0126	Input terminal function selection 16 (L8)	0~135 *1	1/1	0	Disabled	●/●	●	●	7.2.1
F127	0127	Always ON function selection 2	0~135 *1	1/1	0	Disabled	●/●	●	●	6.3.1
F128	0128	Always ON function selection 3	0~135 *1	1/1	0	Disabled	●/●	●	●	6.3.1
F130	0130	Output terminal function selection 1 (OUT1)	0~255 *2	1/1	4	Disabled	●/●	●	●	7.2.2
F131	0131	Output terminal function selection 2 (OUT2)	0~255 *2	1/1	6	Disabled	●/●	●	●	7.2.2
F132	0132	Output terminal function selection 3 (FL)	0~255 *2	1/1	10	Disabled	●/●	●	●	7.2.2
F133	0133	Output terminal function selection 4 (OUT3)	0~255 *2	1/1	254	Disabled	●/●	●	●	7.2.2
F134	0134	Output terminal function selection 5 (OUT4)	0~255 *2	1/1	254	Disabled	●/●	●	●	7.2.2
F135	0135	Output terminal function selection 6 (R1)	0~255 *2	1/1	254	Disabled	●/●	●	●	7.2.2
F136	0136	Output terminal function selection 7 (OUT5)	0~255 *2	1/1	254	Disabled	●/●	●	●	7.2.2
F137	0137	Output terminal function selection 8 (OUT6)	0~255 *2	1/1	254	Disabled	●/●	●	●	7.2.2
F138	0138	Output terminal function selection 9 (R2)	0~255 *2	1/1	254	Disabled	●/●	●	●	7.2.2

*1: ⇒ For the adjustment range, see the table on page K-36.

*2: ⇒ For the adjustment range, see the table on page K-38.

[4] Terminal response time setup

		Sensorless vector/vector with sensor (.:Effective, -:Ineffective, -:Ineffective)									
Title	Communi- cation No.	Function	Adjustment range	Minimum setting unit (Panel/Communi- cation)	Default setting	Write during running	Vector control	PM control	V/f	Reference	
F15B	0168	Output terminal function selection 10 (R3) *1	0~255 *2	1/1	254	Disabled	●/●	●	●	7. 2. 2	
F15G	0169	Output terminal function selection 11 (R4) *1	0~255 *2	1/1	254	Disabled	●/●	●	●	7. 2. 2	
F17D	0170	Base frequency 2	25.0~F Hz	0.1/0.01	*4	Disabled	-	-	●	6. 4. 1	
F17I	0171	Base frequency voltage 2	50~330V/660V	1/0.1	*3	Disabled	-	-	●	6. 4. 1	
F17J	0172	Manual torque boost 2	0.0~30.0%	0.1/0.1	*3	Enabled	-	-	●	6. 4. 1	
F17K	0173	Thermal protection level 2	10~100%	1/1	100	Enabled	-	-	●	6. 4. 1	

*1: Unsupported option

*2: ⇒ For the adjustment range, see the table on page K-38.

*3: Default values vary depending on the capacity. ⇒ See the table of K-41.

*4: inverter with a model number ending with -WN: 60.0 -WP: 50.0

[5] V/f 5-point setting

		Sensorless vector/vector with sensor (.:Effective, -:Ineffective, -:Ineffective)									
Title	Communi- cation No.	Function	Adjustment range	Minimum setting unit (Panel/Communi- cation)	Default setting	Write during running	Vector control	PM control	V/f	Reference	
F19D	0190	V/f 5-point setting VF1 frequency	0.0~F Hz	0.1/0.01	0.0	Disabled	-	-	●	5. 6	
F19I	0191	V/f 5-point setting VF1 voltage	0.0~100.0%	0.1/0.01	0.0	Disabled	-	-	●	5. 6	
F19J	0192	V/f 5-point setting VF2 frequency	0.0~F Hz	0.1/0.01	0.0	Disabled	-	-	●	5. 6	
F19K	0193	V/f 5-point setting VF2 voltage	0.0~100.0%	0.1/0.01	0.0	Disabled	-	-	●	5. 6	
F19L	0194	V/f 5-point setting VF3 frequency	0.0~F Hz	0.1/0.01	0.0	Disabled	-	-	●	5. 6	
F19M	0195	V/f 5-point setting VF3 voltage	0.0~100.0%	0.1/0.01	0.0	Disabled	-	-	●	5. 6	
F19N	0196	V/f 5-point setting VF4 frequency	0.0~F Hz	0.1/0.01	0.0	Disabled	-	-	●	5. 6	
F19O	0197	V/f 5-point setting VF4 voltage	0.0~100.0%	0.1/0.01	0.0	Disabled	-	-	●	5. 6	
F19P	0198	V/f 5-point setting VF5 frequency	0.0~F Hz	0.1/0.01	0.0	Disabled	-	-	●	5. 6	
F19Q	0199	V/f 5-point setting VF5 voltage	0.0~100.0%	0.1/0.01	0.0	Disabled	-	-	●	5. 6	

[6] Speed/torque reference gain/bias setup [1/3]

		Sensorless vector/vector with sensor (.:Effective, -:Ineffective, -:Ineffective)									
Title	Communi- cation No.	Function	Adjustment range	Minimum setting unit (Panel/Communi- cation)	Default setting	Write during running	Vector control	PM control	V/f	Reference	
F20D	0200	Frequency priority selection	0:F F0 d/F F0 7 terminal switching (input terminal function selection 104, 105) 1:F F0 d/F F0 7 frequency switching (switching with F20B)	1/1	0	Enabled	●/●	●	●	6. 6. 1	
F20I	0201	V/f input point 1 setting	0~100%	1/1	0	Enabled	●/●	●	●	7. 3. 2	
F20J	0202	V/f input point 1 frequency	0.0~F Hz	0.1/0.01	0.0	Enabled	●/●	●	●	7. 3. 2	

*1: inverter with a model number ending with -WN: 60.0 -WP: 50.0

*2: ⇒ For details, refer to Instruction Manual (E6581331) specified in Section 6.4.1.



[6] Speed/torque reference gain/bias setup [2/3] Sensorless vector/vector with sensor (:Effective, -:Ineffective)

Title	Commu- nication No.	Function	Adjustment range	Minimum setting unit (Panel/Communi- cation)	Default setting	Write during running	Vector control	PM control	V/f	Reference
F203	0203	Vf11 input point 2 setting	0~100%	1/1	100	Enabled	●/●	●	●	7.3.2
F204	0204	Vf12 input point 2 frequency	0.0~F Hz	0.1/0.01	*1	Enabled	●/●	●	●	5.11
F205	0205	Vf11 input point 1 rate	0~250%	1/0.01	0	Enabled	●/●	-	-	*2
F206	0206	Vf11 input point 2 rate	0~250%	1/0.01	100	Enabled	●/●	-	-	*2
F207	0207	Frequency setting mode selection 2	Same as F206 (1~12)	1/1	1	Disabled	●/●	●	●	6.6.1
F208	0208	Speed command priority switching frequency	0.1~F Hz	0.1/0.01	0.1	Enabled	●/●	●	●	6.6.1
F209	0209	Analog input filter	0:No filter 1:Filter approx. 10ms 2:Filter approx. 15ms 3:Filter approx. 30ms 4:Filter approx. 60ms	1/1	0	Enabled	●/●	●	●	7.2.3
F210	0210	RRS4 input point 1 setting	0~100%	1/1	0	Enabled	●/●	●	●	7.3.1
F211	0211	RRS4 input point 1 frequency	0.0~F Hz	0.1/0.01	0.0	Enabled	●/●	●	●	7.3.1
F212	0212	RRS4 input point 2 setting	0~100%	1/1	100	Enabled	●/●	●	●	7.3.1
F213	0213	RRS4 input point 2 frequency	0.0~F Hz	0.1/0.01	*1	Enabled	●/●	●	●	5.11
F214	0214	RRS4 input point 1 rate	0~250%	1/0.01	0	Enabled	●/●	-	-	*2
F215	0215	RRS4 input point 2 rate	0~250%	1/0.01	100	Enabled	●/●	-	-	*2
F216	0216	RX input point 1 setting	-100~100%	1/1	0	Enabled	●/●	●	●	7.3.3
F217	0217	RX input point 1 frequency	0.0~F Hz	0.1/0.01	0.0	Enabled	●/●	●	●	7.3.3
F218	0218	RX input point 2 setting	-100~100%	1/1	100	Enabled	●/●	●	●	7.3.3
F219	0219	RX input point 2 frequency	0.0~F Hz	0.1/0.01	*1	Enabled	●/●	●	●	7.3.3
F220	0220	RX input point 1 rate	-250~250%	1/0.01	0	Enabled	●/●	-	-	*2
F221	0221	RX input point 2 rate	-250~250%	1/0.01	100	Enabled	●/●	-	-	*2
F222	0222	A11 input point 1 setting	-100~100%	1/1	0	Enabled	●/●	●	●	*3
F223	0223	A11 input point 1 frequency	0.0~F Hz	0.1/0.01	0.0	Enabled	●/●	●	●	*3
F224	0224	A11 input point 2 setting	-100~100%	1/1	100	Enabled	●/●	●	●	*3
F225	0225	A11 input point 2 frequency	0.0~F Hz	0.1/0.01	*1	Enabled	●/●	●	●	*3
F226	0226	A12 input point 1 setting	0~100%	1/1	0	Enabled	●/●	●	●	*3
F227	0227	A12 input point 1 frequency	0.0~F Hz	0.1/0.01	0.0	Enabled	●/●	●	●	*3

*1: This parameter moves to a fundamental parameter.

*2: Inverter with a model number ending with -WN: 60.0 -WP: 50.0

*3: For details, refer to Instruction Manual (E6581331) specified in Section 6.36.

*4: For details, refer to Instruction Manual (E6581341) specified in Section 6.36.

[6] Speed/torque reference gain/bias setup [3/3] Sensorless vector/vector with sensor (: Effective, - : Ineffective, - : Ineffective)

Title	Communi- cation No.	Function	Adjustment range	Minimum setting unit (Panel/Communi- cation)	Default setting	Write during running	Vector control	PM control	V/f	Reference
F ₂ 30	0230	A12 input point 2 setting	0~100%	1/1	100	Enabled	●/●	●	●	*2
F ₂ 31	0231	A12 input point 2 frequency	0.0~F Hz	0.1/0.01	*1	Enabled	●/●	●	●	*2
F ₂ 34	0234	RP/high speed pulse input point 1 setting	0~100%	1/1	0	Enabled	●/●	●	●	*3
F ₂ 35	0235	RP/high speed pulse input point 1 frequency	0.0~F Hz	0.1/0.01	0.0	Enabled	●/●	●	●	*3
F ₂ 36	0236	RP/high speed pulse input point 2 setting	0~100%	1/1	100	Enabled	●/●	●	●	*3
F ₂ 37	0237	RP/high speed pulse input point 2 frequency	0.0~F Hz	0.1/0.01	*1	Enabled	●/●	●	●	*3

*1: Inverter with a model number ending with -WN: 60.0 -W/P: 50.0

*2: → For details, refer to Instruction Manual (E6581341) specified in Section 6.36.

*3: → For details, refer to Instruction Manual (E6581319) specified in Section 6.36.

[7] Operation frequency Sensorless vector/vector with sensor (: Effective, - : Ineffective, - : Ineffective)

Title	Communi- cation No.	Function	Adjustment range	Minimum setting unit (Panel/Communi- cation)	Default setting	Write during running	Vector control	PM control	V/f	Reference
F ₂ 40	0240	Starting frequency setting	0.0~10.0Hz	0.1/0.01	0.1	Enabled	●/●	●	●	6.7.1
F ₂ 41	0241	Operation start frequency	0.0~F Hz	0.1/0.01	0.0	Enabled	●/●	●	●	6.7.2
F ₂ 42	0242	Operation start frequency hysteresis	0.0~30.0Hz	0.1/0.01	0.0	Enabled	●/●	●	●	6.7.2
F ₂ 43	0243	Stop frequency setting	0.0~30.0Hz	0.1/0.01	0.0	Enabled	●/●	●	●	6.7.1
F ₂ 44	0244	Frequency command dead band	0.0~5.0Hz	0.1/0.01	0.0	Enabled	●/●	●	●	6.7.3

[8] DC braking Sensorless vector/vector with sensor (: Effective, - : Ineffective)

Title	Communi- cation No.	Function	Adjustment range	Minimum setting unit (Panel/Communi- cation)	Default setting	Write during running	Vector control	PM control	V/f	Reference
F ₂ 50	0250	DC braking start frequency	0.0~120.0Hz	0.1/0.01	0.0	Enabled	●/●	●	●	6.8.1
F ₂ 51	0251	DC braking current	0~100%	1/1	50	Enabled	●/●	●	●	6.8.1
F ₂ 52	0252	DC braking time	0.0~20.0 sec.	0.1/0.1	1.0	Enabled	●/●	●	●	6.8.1
F ₂ 53	0253	Forward/reverse DC braking priority control	0:Disabled 1:Enabled	1/1	0	Enabled	●/●	●	●	6.8.1
F ₂ 54	0254	Motor shaft fixing control	0:Disabled 1:Enabled	1/1	0	Enabled	●/●	●	●	6.8.2
F ₂ 55	0255	0Hz command output selection	0:Default (DC braking) 1:0Hz command	1/1	0	Enabled	-/●	●	●	6.8.3
F ₂ 56	0256	Time limit for lower-limit frequency operation	0.0:Disabled, 0.1~600.0 sec.	0.1/0.1	0.0	Enabled	●/●	●	●	6.9



11

[9] Jogging operation

Sensorless vector/vector with sensor (: Effective, -: Ineffective, -: Ineffective)

Title	Communi- cation No.	Function	Adjustment range	Minimum setting unit (Panel/Communi- cation)	Default setting	Write during running	Vector control	PM control	V/f	Reference
F ₂ 50	0260	Jog run frequency	F ₂ 40~20.0Hz 0:Deceleration stop 1:Coast stop 2:DC braking stop	0.1/0.01	5.0	Enabled	●/●	●	●	6. 10
F ₂ 51	0261	Jog run stop pattern	0:Disabled 1:Operation panel jog run mode enabled	1/1	0	Disabled	●/●	●	●	6. 10
F ₂ 52	0262	Operation panel jog run mode	0:Disabled 1:Operation panel jog run mode enabled	1/1	0	Enabled	●/●	●	●	6. 10
F ₂ 54	0264	Input from external contacts - UP response time	0.0~10.0 sec.	0.1/0.1	0.1	Enabled	●/●	●	●	6. 11
F ₂ 55	0265	Input from external contacts - UP frequency step	0.0~F Hz	0.1/0.01	0.1	Enabled	●/●	●	●	6. 11
F ₂ 55	0266	Input from external contacts - DOWN response time	0.0~10.0 sec.	0.1/0.1	0.1	Enabled	●/●	●	●	6. 11
F ₂ 57	0267	Input from external contacts - DOWN frequency step	0.0~F Hz	0.1/0.01	0.1	Enabled	●/●	●	●	6. 11
F ₂ 58	0268	Initial UP/DOWN frequency	L~L~H Hz 0:Not changed 1:Setting of F ₂ 58 changed when power is turned off	0.1/0.01	0.0	Enabled	●/●	●	●	6. 11
F ₂ 59	0269	Initial up/down frequency rewriting		1/1	1	Enabled	●/●	●	●	6. 11

[10] Jump frequency

Sensorless vector/vector with sensor (: Effective, -: Ineffective, -: Ineffective)

Title	Communi- cation No.	Function	Adjustment range	Minimum setting unit (Panel/Communi- cation)	Default setting	Write during running	Vector control	PM control	V/f	Reference
F ₂ 70	0270	Jump frequency 1	0.0~F Hz	0.1/0.01	0.0	Enabled	●/●	●	●	6. 12
F ₂ 71	0271	Jumping width 1	0.0~30.0Hz	0.1/0.01	0.0	Enabled	●/●	●	●	6. 12
F ₂ 72	0272	Jump frequency 2	0.0~F Hz	0.1/0.01	0.0	Enabled	●/●	●	●	6. 12
F ₂ 73	0273	Jumping width 2	0.0~30.0Hz	0.1/0.01	0.0	Enabled	●/●	●	●	6. 12
F ₂ 74	0274	Jump frequency 3	0.0~F Hz	0.1/0.01	0.0	Enabled	●/●	●	●	6. 12
F ₂ 75	0275	Jumping width 3	0.0~30.0Hz	0.1/0.01	0.0	Enabled	●/●	●	●	6. 12

[11] Preset speed operation frequency (8~15) [1/2]

Sensorless vector/vector with sensor (: Effective, -: Ineffective, -: Ineffective)

Title	Communi- cation No.	Function	Adjustment range	Minimum setting unit (Panel/Communi- cation)	Default setting	Write during running	Vector control	PM control	V/f	Reference
F ₂ 87	0287	Preset speed operation frequency 8	L~L~H Hz	0.1/0.01	0.0	Enabled	●/●	●	●	5. 12
F ₂ 88	0288	Preset speed operation frequency 9	L~L~H Hz	0.1/0.01	0.0	Enabled	●/●	●	●	5. 12
F ₂ 89	0289	Preset speed operation frequency 10	L~L~H Hz	0.1/0.01	0.0	Enabled	●/●	●	●	5. 12
F ₂ 90	0290	Preset speed operation frequency 11	L~L~H Hz	0.1/0.01	0.0	Enabled	●/●	●	●	5. 12
F ₂ 91	0291	Preset speed operation frequency 12	L~L~H Hz	0.1/0.01	0.0	Enabled	●/●	●	●	5. 12
F ₂ 92	0292	Preset speed operation frequency 13	L~L~H Hz	0.1/0.01	0.0	Enabled	●/●	●	●	5. 12

[11] Preset speed operation frequency (8~15) [2/2]

Sensorless vector/vector with sensor (.:Effective, -:Ineffective, ..:Ineffective)

Title	Communication No.	Function	Adjustment range	Minimum setting unit (Panel/Communication)	Default setting	Write during running	Vector control	PM control	V/f	Reference
F 2 9 3	0293	Preset speed operation frequency 14	L L ~U L Hz	0.1/0.01	0.0	Enabled	●/●	●	●	5. 12
F 2 9 4	0294	Preset speed operation frequency 15 (Forced operation frequency)	L L ~U L Hz	0.1/0.01	0.0	Enabled	●/●	●	●	5. 12
F 2 9 5	0295	Bumpless operation selection	1:Disabled 2:Enabled	1/1	0	Enabled	●/●	●	●	6. 14

[12] Tripless intensification setup [1/2]

Sensorless vector/vector with sensor (.:Effective, -:Ineffective, ..:Ineffective)

Title	Communication No.	Function	Adjustment range	Minimum setting unit (Panel/Communication)	Default setting	Write during running	Vector control	PM control	V/f	Reference
L F	0300	PWM carrier frequency	1.0~16.0kHz (2.5~8.0kHz) *1 0:Disabled 1:At auto-restart 2:When turning ST operation standby signal on or off 3:1+2, 4:Starting	0.1/0.1	*2	Enabled	●/●	●	●	5. 17
U J 5	0301	Auto-restart control selection	0:Disabled 1:Power ride-through 2:Deceleration stop during power failure 3:1+2, 4:Starting	1/1	0	Disabled	●/●	●	●	5. 18. 1
U J L	0302	Regenerative power ride-through control	0:Disabled 1:Power ride-through 2:Deceleration stop during power failure	1/1	0	Disabled	●/●	●	●	5. 18. 2
F 3 0 3	0303	Retry selection	0:Deselect, 1-10 times	1/1	0	Enabled	●/●	●	●	6. 15. 1
P b	0304	Dynamic braking selection	0:Disabled 1:Enabled (braking resistance overload detect) 2:Enabled (braking resistance overload not detect)	1/1	0	Disabled	●/●	●	●	5. 19
F 3 0 5	0305	Overvoltage limit operation	0:Enabled 1:Disabled (quick deceleration) 2:Enabled (quick deceleration) 3:Enabled (dynamic quick deceleration)	1/1	2	Disabled	●/●	●	●	6. 15. 2

This parameter moves to a fundamental parameter.
 *1: For 200V-55kW to 200V-90kW models and 400V-90kW to 400V-630kW models, the carrier frequency is between 2.5 and 8.0kHz inclusive.
 *2: Default values vary depending on the capacity. ⇒ See the table of K-41.

[12] Tripless intensification setup [2/2] Sensorless vector/vector with sensor (:Effective, -:Ineffective, -:Ineffective)

Title	Communi- cation No.	Function	Adjustment range	Minimum setting unit (Panel/Communi- cation)	Default setting	Write during running	Vector control	PM control	V/f	Reference
$F307$	0307	Base frequency voltage selection (correction of supply voltage)	0:Without voltage compensation (limitless output voltage) 1:With voltage compensation (limitless output voltage) 2:Without voltage compensation (limited output voltage) 3:With voltage compensation (limited output voltage)	1/1	0	Disabled	Parameter is changeable, but fixed to "with voltage compensation" internally. When $F307$ is set to 0 or 1, fixed at 1 internally. When $F307$ is set to 2 or 3, fixed at 3 internally.		•	6. 15. 3
$P308$	0308	Dynamic braking resistance	0.5~1000.0	0.1/0.1	*1	Disabled	•/•	•	•	5. 19
$P309$	0309	Allowable continuous braking resistance	0.01~600.0kW	0.01/0.01	*1	Disabled	•/•	•	•	5. 19
$F310$	0310	Non-stop control time/deceleration time during power failure	0.1~320.0 sec.	0.1/0.1	2.0	Enabled *2 Disabled	•/•	•	•	5. 18. 2
$F311$	0311	Reverse-run prohibition selection	0:Permit all 1:Prohibit reverse run 2:Prohibit forward run	1/1	0	Disabled	•/•	•	•	6. 15. 4
$F312$	0312	Random mode	0:Disabled, 1:Enabled	1/1	0	Disabled	•/•	•	•	5. 17
$F315$	0316	Carrier frequency control mode selection	0:Not decrease carrier frequency automatically 1:Decrease carrier frequency automatically 2:Not decrease carrier frequency automatically, 400V class supported 3:Decrease carrier frequency automatically, 400V class supported	1/1	1	Disabled	•/•	•	•	5. 17
$F319$	0319	Regenerative over-excitation upper limit	100~180%	1/1	140	Disabled	•/•	-	•	6. 15. 2

*1: This parameter moves to a fundamental parameter.
 *2: Default values vary depending on the capacity. → See the table of K-41.
 *3: Although the setting can be written into memory if $F319$ is set to 1 (power ride-through control), it cannot be written if $F319$ is set to 2 (deceleration stop during a power failure).

[13] Drooping control Sensorless vector/vector with sensor (:Effective, -:Ineffective)

Title	Communi- cation No.	Function	Adjustment range	Minimum setting unit (Panel/Communi- cation)	Default setting	Write during running	Vector control	PM control	V/f	Reference
$F320$	0320	Drooping gain	0.0~100.0% (Enabled if $P320=3$ or 7)	0.1/0.1	0.0	Enabled *1	•/•	-	-	6. 16
$F321$	0321	Speed at drooping gain 0%	0.0~320.0Hz (Enabled if $P320=3$ or 7)	0.1/0.01	0.0	Enabled	•/•	-	-	6. 16
$F322$	0322	Speed at drooping gain $F320$	0.0~320.0Hz (Enabled if $P320=3$ or 7)	0.1/0.01	0.0	Enabled	•/•	-	-	6. 16
$F323$	0323	Drooping insensitive torque	0~100% (Enabled if $P320=3$ or 7)	1/1	10	Enabled	•/•	-	-	6. 16

*1: Drooping gain can be changed within a range of 0.1 to 100.0% during operation. When changing the setting to 0.0 (no drooping) or 0.0, stop operation.

§Sensorless vector/vector with sensor (:Effective, -:Ineffective, -:Ineffective)

Title	Communi- cation No.	Function	Adjustment range	Minimum setting unit (Panel/Communi- cation)	Default setting	Write during running	Vector control	PM control	V/f	Reference
F 3 2 4	0324	Drooping output filter	0.1~200.0 rad/s (Enabled if P L = 3 or 7)	0.1/0.1	100.0	Enabled	●/●	-	-	6. 16

§Sensorless vector/vector with sensor (:Effective, -:Ineffective)

Title	Communi- cation No.	Function	Adjustment range	Minimum setting unit (Panel/Communi- cation)	Default setting	Write during running	Vector control	PM control	V/f	Reference
F 3 5 4	0354	Commercial power/inverter switching output selection	0:Disabled 1:Automatic switching in the event of a trip 2:Commercial power switching frequency setting 3:Commercial power switching frequency setting + automatic switching in the event of a trip	1/1	0	Disabled	●/●	●	●	6. 17
F 3 5 5	0355	Commercial power/inverter switching frequency	0~U L Hz	0.1/0.01	*2	Enabled	●/●	●	●	6. 17
F 3 5 6	0356	Inverter-side switching waiting time	0.10~10.00 sec.	0.01/0.01	*1	Enabled	●/●	●	●	6. 17
F 3 5 7	0357	Commercial power-side switching waiting time	0.40~10.00 sec.	0.01/0.01	0.62	Enabled	●/●	●	●	6. 17
F 3 5 8	0358	Commercial power switching frequency holding time	0.10~10.00 sec.	0.01/0.01	2.00	Enabled	●/●	●	●	6. 17

*1: Default values vary depending on the capacity. ⇒ See the table of K-41. *2: Inverter with a model number ending with -WN: 60.0 -WP: 50.0

§Sensorless vector/vector with sensor (:Effective, -:Ineffective)

Title	Communi- cation No.	Function	Adjustment range	Minimum setting unit (Panel/Communi- cation)	Default setting	Write during running	Vector control	PM control	V/f	Reference
F 3 5 9	0359	PID control switching	0:No PID control 1:Process type PID control (temp./pressure, etc.) operation 2:Speed type PID control (potentiometer, etc.) operation	1/1	0	Disabled	●/●	●	●	6. 18 *1
F 3 6 0	0360	PID control feedback control signal selection	0:Deviation input (no feedback input) 1:VR/I (voltage/current input) 2:RR/S4 (potentiometer/voltage input) 3:RX (voltage input) 4:Optional AI1 (differential current input) 5:Optional AI2 (voltage/current input) 6:PG feedback option	1/1	0	Disabled	●/●	●	●	6. 18 *1
F 3 6 1	0361	Delay filter	0.0~25.0	1/1	0.1	Enabled	●/●	●	●	6. 18 *1
F 3 6 2	0362	Proportional (P) gain	0.01~100.0	0.01/0.01	0.10	Enabled	●/●	●	●	6. 18 *1
F 3 6 3	0363	Integral (I) gain	0.01~100.0	0.01/0.01	0.10	Enabled	●/●	●	●	6. 18 *1
F 3 6 4	0364	PID deviation upper limit	L L ~U L Hz	0.10/0.1	*2	Enabled	●/●	●	●	6. 18 *1

*1: ⇒ For details, refer to Instruction Manual (E6581329) specified in Section 6.36. *2: Inverter with a model number ending with -WN: 60.0 -WP: 50.0



11

[16] PID control [2/2] Sensorless vector/vector with sensor (:Effective, -:Ineffective, -:Ineffective)

Title	Communi- cation No.	Function	Adjustment range	Minimum setting unit (Panel/Communi- cation)	Default setting	Write during running	Vector control	PM control	V/f	Reference
F 3 6 5	0365	PID deviation lower limit	L L ~H H Hz	0.1/0.01	*2	Enabled	●/●	●	●	6. 18 *1
F 3 6 6	0366	Differential (D) gain	0.00~2.55	0.0/0.01	0.00	Enabled	●/●	●	●	6. 18 *1
F 3 6 7	0367	Process upper limit	L L ~H H Hz	0.1/0.01	*2	Enabled	●/●	●	●	6. 18 *1
F 3 6 8	0368	Process lower limit	L L ~H H Hz	0.1/0.01	L L	Enabled	●/●	●	●	6. 18 *1
F 3 6 9	0369	PID control waiting time	0~2400 sec.	1/1	0	Enabled	●/●	●	●	6. 18 *1
F 3 7 0	0370	PID output upper limit	L L ~H H Hz	0.1/0.01	*2	Enabled	●/●	●	●	6. 18 *1
F 3 7 1	0371	PID output lower limit	L L ~H H Hz	0.1/0.01	L L	Enabled	●/●	●	●	6. 18 *1
F 3 7 2	0372	Process increasing rate (speed type PID control)	0.1~600.0	0.1/0.1	10.0	Enabled	●/●	●	●	6. 18 *1
F 3 7 3	0373	Process decreasing rate (speed type PID control)	0.1~600.0	0.1/0.1	10.0	Enabled	●/●	●	●	6. 18 *1
F 3 7 4	0374	Frequency command agreement detection range	0.0~F H Hz	0.1/0.01	2.5	Enabled	●/●	●	●	6. 18 *1

*1: ⇒ For details, refer to Instruction Manual (E6581329) specified in Section 6.36.

*2: Inverter with a model number ending with -WN: 60.0 -WP: 50.0

[17] Speed feedback/positioning control Sensorless vector/vector with sensor (:Effective, -:Ineffective, -:Ineffective)

Title	Communi- cation No.	Function	Adjustment range	Minimum setting unit (Panel/Communi- cation)	Default setting	Write during running	Vector control	PM control	V/f	Reference
F 3 7 5	0375	Number of PG input pulses	12~9999	1/1	500	Disabled	-/●	-	-	*1
F 3 7 6	0376	Selection of number of PG input phases	1:Single-phase input 2:Two-phase input 3:Two-phase input (inversion of polarity)	1/1	2	Disabled	-/●	-	-	*1
F 3 7 7	0377	PG disconnection detection	0:Disabled 1:Enabled (with filter) 2:Enabled (Detection of momentary power failure)	1/1	0	Disabled	-/●	-	-	*1
F 3 7 8	0378	Number of RP terminal input pulses	12~9999	1/1	500	Disabled	●/●	●	●	*2

*1: ⇒ For details, refer to Instruction Manual (E6581319) specified in Section 6.36.

*2: ⇒ For details, refer to Instruction Manual (E6581341) specified in Section 6.36.

[18] Motor constant sensorless vector/vector with sensor (: Effective, - : Ineffective, - : Ineffective)

Communi cation No.	Function	Adjustment range	Minimum setting unit (Panel/Communi cation)	Default setting	Write during running	Vector control	PM control	Vf/Const	Reference
F 4 0 0	Auto-tuning 1	0:No auto-tuning 1:Initialize motor constant (0 after execution) 2:Continue operation continued after auto-tuning (0 after execution) 3:Auto-tuning by input terminal signal 4:Motor constant auto calculation (0 after execution)	1/1	0	Disabled	●/●	-	-	6. 19
F 4 0 1	Slip frequency gain	0~150%	1/1	70	Enabled	●/-	-	-	6. 19
F 4 0 2	Auto-tuning 2	0:Disabled 1:Self-cooled motor 2:Forced air-cooled motor	1/1	0	Disabled	●/●	-	-	6. 19
F 4 0 5	Motor rated capacity (motor name plate)	0.1~630.0kW	0.01/0.01	*1	Disabled	●/●	-	-	6. 19
F 4 0 6	Motor rated current (motor name plate)	0.1~2000A	0.1/0.1	*1	Disabled	●/●	-	-	6. 19
F 4 0 7	Motor rated rotational speed (motor name plate)	100~60000min-1 *2	1/1	*1	Disabled	●/●	-	-	6. 19
F 4 1 0	Motor constant 1 (torque boost)	0.0~30.0%	0.1/0.1	*1	Enabled	●/●	-	-	6. 19
F 4 1 1	Motor constant 2 (no load current)	10~90%	1/1	*1	Disabled	●/●	-	-	6. 19
F 4 1 2	Motor constant 3 (leak inductance)	0~200%	0.1/0.1	*1	Disabled	●/●	-	-	6. 19
F 4 1 3	Motor constant 4 (rated slip)	0.1~25.0%	0.1/0.1	*1	Disabled	●/●	-	-	6. 19
F 4 1 5	Exciting strengthening coefficient	100~130%	1/1	100	Disabled	●/●	-	-	6. 20
F 4 1 6	Stall prevention factor	10~250	1/1	100	Disabled	●/●	-	-	6. 20

*1: Default values vary depending on the capacity. → See the table of K-41.

*2: If the speed or rotation is set at 10,000min⁻¹ or more, the error messages **1000** and **E 1** (if the speed of rotation is set at 10,000min⁻¹) are displayed alternately.

[19] Torque limit sensorless vector/vector with sensor (: Effective, - : Ineffective, - : Ineffective)

Communi cation No.	Function	Adjustment range	Minimum setting unit (Panel/Communi cation)	Default setting	Write during running	Vector control	PM control	Vf/Const	Reference
F 4 4 0	Power running torque limit selection	1:V/I (voltage/current input) 2:RR/SA (potentiometer/voltage input) 3:RX (voltage input) 4:F 4 4 1	1/1	4	Enabled	●/●	●	-	6. 21
F 4 4 1	Power running torque limit level	0.0~249.9%, 250.0:Disabled	0.1/0.01	250.0	Enabled	●/●	●	-	6. 21
F 4 4 2	Regenerative braking torque limit selection	1:V/I (voltage/current input) 2:RR/SA (potentiometer/voltage input) 3:RX (voltage input) 4:F 4 4 3	1/1	4	Enabled	●/●	●	-	6. 21
F 4 4 3	Regenerative braking torque limit 1 level	0.0~249.9%, 250.0:Disabled	0.1/0.01	250.0	Enabled	●/●	●	-	6. 21
F 4 5 4	Constant output zone torque limit selection	0:Constant output limit 1:Constant torque limit	1/1	0	Disabled	●/●	●	-	6. 21



11

[20] Adjustment parameters

Title	Communi- cation No.	Function	Adjustment range	Minimum setting unit (Panel/Communi- cation)	Default setting	Write during running	Vector control	PM control	Vf/Constant	Reference
F 4 5 0	0460	Speed loop proportional gain.	1~9999	1/1	12	Enabled	●/●	-	-	*1
F 4 5 1	0461	Speed loop stabilization coefficient	1~9999	1/1	100	Enabled	●/●	-	-	*1
F 4 5 2	0462	Moment of inertia of load 1	0~100	1/1	35	Enabled	●/●	●	●	*1
F 4 7 0	0470	Vf/I1 input bias	0~255	1/1	*2	Enabled	●/●	●	●	6. 23
F 4 7 1	0471	Vf/I1 input gain	0~255	1/1	*2	Enabled	●/●	●	●	6. 23
F 4 7 2	0472	RR/S4 input bias	0~255	1/1	*2	Enabled	●/●	●	●	6. 23
F 4 7 3	0473	RR/S4 input gain	0~255	1/1	*2	Enabled	●/●	●	●	6. 23
F 4 7 4	0474	RX input bias	0~255	1/1	*2	Enabled	●/●	●	●	6. 23
F 4 7 5	0475	RX input gain	0~255	1/1	*2	Enabled	●/●	●	●	6. 23
F 4 7 6	0476	Optional AI1 input bias	0~255	1/1	*2	Enabled	●/●	●	●	6. 23
F 4 7 7	0477	Optional AI1 input gain	0~255	1/1	*2	Enabled	●/●	●	●	6. 23
F 4 7 8	0478	Optional AI2 input bias	0~255	1/1	*2	Enabled	●/●	●	●	6. 23
F 4 7 9	0479	Optional AI2 input gain	0~255	1/1	*2	Enabled	●/●	●	●	6. 23
F 4 9 8	0498	PM motor constant 1 (d axis inductance)	0~25%	0.1/0.1	10.0	Disabled	-	-	-	6. 24
F 4 9 9	0499	PM motor constant 2 (q axis inductance)	0~25%	0.1/0.1	10.0	Disabled	-	-	-	6. 24

*1: ⇒ For details, refer to Instruction Manual (E6581333) specified in Section 6.36

*2: ⇒ Settings vary from unit to unit. Even if L 3 P is set to 3, no change is made to these values.

[21] Acceleration/deceleration 2

Title	Communi- cation No.	Function	Adjustment range	Minimum setting unit (Panel/Communi- cation)	Default setting	Write during running	Vector control	PM control	Vf/Constant	Reference
F 5 0 0	0500	Acceleration time 2	0.1~6000 sec.	0.1/0.1 *2	*1	Enabled	●/●	●	●	6. 25. 1
F 5 0 1	0501	Deceleration time 2	0.1~6000 sec.	0.1/0.1 *2	*1	Enabled	●/●	●	●	6. 25. 1
F 5 0 2	0502	Acceleration/deceleration 1 pattern	0: Straight 1: S-pattern 1 2: S-pattern 2	1/1	0	Enabled	●/●	●	●	6. 25. 1
F 5 0 3	0503	Acceleration/deceleration 2 pattern	0: Straight 1: S-pattern 1 2: S-pattern 2	1/1	0	Enabled	●/●	●	●	6. 25. 1
F 5 0 4	0504	Panel acceleration/deceleration selection	1: Acceleration/deceleration 1 2: Acceleration/deceleration 2	1/1	1	Enabled	●/●	●	●	6. 25. 1
F 5 0 5	0505	Acceleration/deceleration switching frequency	0.0~F Hz	0.1/0.01	0.0	Enabled	●/●	●	●	6. 25. 1

*1: Default values vary depending on the capacity. ⇒ See the table of K-41.

*2: Changing the parameter L 4 P enables to set to 0.01 sec. (adjustment range: 0.01~600.0 sec.)

[22] Protection functions [1/3] Sensorless vector/vector with sensor (: Effective, - : Ineffective, - : Ineffective)

Title	Communication No.	Function	Adjustment range	Minimum setting unit (Panel/Communication)	Default setting	Write during running	Vector control	PM control	Vf/Constant	Reference
F501	0601	Stall prevention level	0~164%, 165:Deactivated 0:Clear when power is turned off 1:Retain even after power is turned off	1/1	120	Enabled	●/●	●	●	6.26.1
F502	0602	Inverter trip record retention selection	0:Coast stop 1:Deceleration stop 2:Emergency DC braking	1/1	0	Enabled	●/●	●	●	6.26.2
F503	0603	Emergency stop	0:Coast stop 1:Deceleration stop 2:Emergency DC braking	1/1	0	Disabled	●/●	●	●	6.26.3
F504	0604	Emergency DC braking control time	0.0~20.0 sec. 0:Disable 1:At starting (only one time after power is turned on) 2:At starting (each time power is turned on) 3:During operation 4:At starting + during operation 5:Output cut-off detection enabled	0.1/0.1	1.0	Enabled	●/●	●	●	6.26.3
F505	0605	Output phase failure detection mode selection	0:No trip 1:Trip	1/1	0	Disabled	●/●	●	●	6.26.4
F506	0606	OL reduction starting frequency	0.0~60.0Hz 0:Disabled 1:Enabled	0.1/0.01	6.0	Enabled	●/●	●	●	5.14
F508	0608	Input phase failure detection mode selection	0:No trip 1:Trip	1/1	1	Disabled	●/●	●	●	6.26.6
F509	0609	Low current detection hysteresis width	1~20%	1/1	10	Enabled	●/●	●	●	6.26.7
F510	0610	Low current trip selection	0:No trip 1:Trip	1/1	0	Enabled	●/●	●	●	6.26.7
F511	0611	Low current detection current	0~100%	1/1	0	Enabled	●/●	●	●	6.26.7
F512	0612	Low current detection time	0~255 sec. 0:Each time (standard pulse) 1:Only one time after power is turned on 2:Each time (short pulse) 3:Only one time after power is turn on (short pulse) 4:Each time (Extremely short-time pulse) 5:Only one time after power is turn on (Extremely short-time pulse)	1/1	0	Enabled	●/●	●	●	6.26.7
F513	0613	Selection of short circuit detection at starting	0:No trip 1:Trip	1/1	0	Disabled	●/●	●	●	6.26.8
F515	0615	Overtorque trip selection	0:No trip 1:Trip	1/1	0	Enabled	●/●	●	●	6.26.9
F516	0616	Overtorque detection level during power running	0~250%	1/0.01	150	Enabled	●/●	●	●	6.26.9
F517	0617	Overtorque detection level during regenerative braking	0~250%	1/0.01	150	Enabled	●/●	●	●	6.26.9
F518	0618	Overtorque detection time	0.00~10.00 sec.	0.01/0.01	0.50	Enabled	●/●	●	●	6.26.9
F519	0619	Overtorque detection hysteresis	0~100%	1/0.01	10	Enabled	●/●	●	●	6.26.9



[22] Protection functions [2/3]		Sensorless vector/vector with sensor (:Effective, -:Ineffective, -:Ineffective)								
Title	Commu- nication No.	Function	Adjustment range	Minimum setting unit (Panel/Communi- cation)	Default setting	Write during running	Vector control	PM control	Vf/Constant	Reference
F 5 2 0	0620	Cooling fan control selection	0:Auto 1:Always ON	1/1	0	Enabled	●/●	●	●	6. 26. 10
F 5 2 1	0621	Cumulative operation time alarm setting	0.1~999.9 (x100h)	0.1/0.1	610.0	Enabled	●/●	●	●	6. 26. 11
F 5 2 2	0622	Abnormal speed detection time	0.01~100.0 sec.	0.01/0.01	0.01	Enabled	-/●	-	-	6. 26. 12
F 5 2 3	0623	Overspeed detection frequency upper band	0.0:Disabled, 0.1~30.0Hz	0.1/0.01	0.0	Enabled	-/●	-	-	6. 26. 12
F 5 2 4	0624	Overspeed detection frequency lower band	0.0:Disabled, 0.1~30.0Hz	0.1/0.01	0.0	Enabled	-/●	-	-	6. 26. 12
F 5 2 5	0626	Oversvoltage limit operation level	100~150%	1/1	134	Disabled	●/●	●	●	6. 15. 2
F 5 2 7	0627	Undervoltage trip selection	0:Disabled 1:Enabled	1/1	0	Disabled	●/●	●	●	6. 26. 14
F 5 3 1	0631	Temperature detection	0:Standard (120%·60 sec.) 1:Estimation of temperature	1/1	0	Disabled	-	-	-	5. 14
F 6 3 3	0633	Vf/II analog input wire breakage detection level	0:None 1~100%	1/1	0	Enabled	●/●	●	●	6. 26. 15
F 5 3 4	0634	Annual average ambient temperature (calculation for part replacement alarms)	1~10~+10°C 2+11~+20°C 3+21~+30°C 4+31~+40°C 5+41~+50°C 6+51~+60°C	1/1	3	Enabled	●/●	●	●	6. 26. 16
F 5 3 5	0635	Rush current suppression relay activation time	0.0~2.5 sec.	0.1/0.1	0.0	Disabled	●/●	●	●	6. 26. 27
F 5 3 7	0637	PTC1 thermal selection	0:Deselect 1:Select	1/1	0	Disabled	●/●	●	●	*1
F 5 3 8	0638	PTC2 thermal selection	0:Deselect 1:Select	1/1	0	Disabled	●/●	●	●	*1
F 5 3 9	0639	Braking resistance overload time (10 times of rated torque)	0.1~600.0 sec.	0.1/0.1	5.0	Disabled	●/●	●	●	5. 19
F 5 4 0	0640	Step-out detection current level (for PM motors)	10~150	1/1	100	Disabled	-	●	-	6. 24
F 5 4 1	0641	Step-out detection time (for PM motors)	0.0:Not detect 0.1~25.0	0.1/0.1	0.0	Disabled	-	●	-	6. 24
F 5 4 3	0643	Brake-equipped motor restart condition selection	0:Default (no waiting time for frequencies of 10Hz and less) 1:Conditional (no waiting time for frequencies of 20Hz and less)	1/1	0	Disabled	●/●	●	●	6. 26. 20
F 5 4 4	0644	Action in the event of Vf/II analog input wire breakage	0:Trip mode 1: The inverter operates the motor at preset speed operation frequency 14.	1/1	0	Disabled	●/●	●	●	6. 26. 15
F 5 4 5	0645	PTC thermal selection	0:Disabled 1:Enabled (trip mode) 2:Enabled (alarm mode)	1/1	0	Disabled	●/●	●	●	6. 26. 21
F 5 4 6	0646	PTC detection resistor value	100~9999Ω	1/1	3000	Disabled	●/●	●	●	6. 26. 21

*1: → For details, refer to Instruction Manual (E6581339) specified in Section 6.36.

Sensorless vector/vector with sensor (:Effective, -:Ineffective, -:Ineffective)

Title	Communication No.	Function	Adjustment range	Minimum setting unit (Panel/Communication)	Default setting	Write during running	Vector control	PM control	Vf/Const	Reference
F547	0647	Control power supply backup option failure monitoring	0:Control power supply not backed up 1:Control power supply backed up (alarm in the event of a failure) 2:Control power supply backed up (tripping in the event of a failure)	1/1	0	Disabled	•/•	•	•	6.26.22
F550	0650	Forced fire-speed control selection	0:Disabled, 1:Enabled	1/1	0	Enabled	•/•	•	•	6.27
F551	0651	Undertorque detection selection	0:Alarm mode, 1:Trip mode	1/1	0	Enabled	•/•	•	•	6.28
F552	0652	Undertorque detection level during power running	0~250%	1/0.01	0	Enabled	•/•	•	•	6.28
F553	0653	Undertorque detection level during regenerative braking	0~250%	1/0.01	0	Enabled	•/•	•	•	6.28
F554	0654	Undertorque detection time	0.00~10.00 sec.	0.01/0.01	0.50	Enabled	•/•	•	•	6.28
F555	0655	Undertorque detection hysteresis	0~100%	1/0.01	10	Enabled	•/•	•	•	6.28

Sensorless vector/vector with sensor (:Effective, -:Ineffective, -:Ineffective)

Title	Communication No.	Function	Adjustment range	Minimum setting unit (Panel/Communication)	Default setting	Write during running	Vector control	PM control	Vf/Const	Reference
F550	0660	Override addition input selection	0:Disabled 1:Vf/II (voltage/current input) 2:RR/S4 (potentiometer/voltage input) 3:RX (voltage input) 4:Operation panel input enabled (including LED/LCD option input) 5:2-wire RS485 input enabled 6:4-wire RS485 input enabled 7:Communications option input enabled 8:Optional A11 (differential current input) 9:Optional A12 (voltage/current input) 10:UP/DOWN frequency 11:Optional RP pulse input 12:Optional high-speed pulse input 13:Optional binary/BCD input 0:Disabled 1:Vf/II 2:RR/S4 3:RX 4:- 5:Optional A11	1/1	0	Enabled	•/•	•	•	6.29
F551	0661	Override multiplication input selection	1:Vf/II 2:RR/S4 3:RX 4:- 5:Optional A11	1/1	0	Enabled	•/•	•	•	6.29
F559	0669	Logic output/pulse output selection (OUT1)	0:Logic output, 1:Pulse output	1/1	0	Disabled	•/•	•	•	6.30.1
F55L	0670	AM terminal meter selection	0~64 *1	1/1	2	Enabled	•/•	•	•	5.16

*1: ⇒ For the adjustment range, see the table on page K-34.



11

[24] Meter output		Sensorless vector/vector with sensor (: Effective, -: Ineffective, -: Ineffective)									
Title	Communication No.	Function	Adjustment range	Minimum setting unit (Panel/Communication)	Default setting	Write during running	Vector control	PM control	V/f Constant	Reference	
F.5.7.1	0671	AM terminal meter adjustment	-	1/1	-	Enabled	●/●	●	●	5.16	
F.5.7.2	0672	MON1 terminal meter selection	0-64 *1	1/1	4	Enabled	●/●	●	●	*2	
F.5.7.3	0673	MON1 terminal meter adjustment	-	1/1	-	Enabled	●/●	●	●	*2	
F.5.7.4	0674	MON2 terminal meter selection	0-64 *1	1/1	5	Enabled	●/●	●	●	*2	
F.5.7.5	0675	MON2 terminal meter adjustment	-	1/1	-	Enabled	●/●	●	●	*2	
F.5.7.6	0676	Pulse output function selection	0-49 *1	1/1	0	Enabled	●/●	●	●	6.30.1	
F.5.7.7	0677	Selection of number of pulses	1.00~43.20kHz	0.01/0.01	3.84	Enabled	●/●	●	●	6.30.1	
F.5.7.8	0678	Constant at the time of filtering	4msec. 8msec~100msec	1/1	64	Enabled	●/●	●	●	5.16	
F.5.8.1	0681	FM voltage/current output switching	0:Voltage 0~10V output 1:Current 0~20mA output	1/1	0	Disabled	●/●	●	●	6.30.3	
F.5.8.2	0682	FM output gradient characteristic	0:Negative gradient (descending) 1:Positive gradient (ascending)	1/1	1	Enabled	●/●	●	●	6.30.3	
F.5.8.3	0683	FM bias adjustment	-10.0~100.0% 0:No filter 1:Filter approx. 10ms 2:Filter approx. 15ms 3:Filter approx. 30ms 4:Filter approx. 60ms	0.1/0.1	0.0	Enabled	●/●	●	●	6.30.3	
F.5.8.4	0684	FM output filter		1/1	0	Enabled	●/●	●	●	5.16	
F.5.8.5	0685	AM output gradient characteristic	0:Negative inclination (downward slope) 1:Positive inclination (upward slope)	1/1	1	Enabled	●/●	●	●	6.30.3	
F.5.8.6	0686	AM bias adjustment	-10.0~100.0% 0:Voltage -10~10V output 1:Voltage 0~10V output 2:Current 0~20mA output	0.1/0.1	0.0	Enabled	●/●	●	●	6.30.3	
F.5.8.8	0688	MON1 voltage/current output switching		1/1	1	Disabled	●/●	●	●	*2	
F.5.8.9	0689	MON1 output gradient characteristic	0:Negative inclination (downward slope) 1:Positive inclination (upward slope)	1/1	1	Enabled	●/●	●	●	*2	
F.5.9.0	0690	MON1 bias adjustment	-10.0~100.0% 0:Voltage -10~10V output 1:Voltage 0~10V output 2:Current 0~20mA output	0.1/0.1	0.0	Enabled	●/●	●	●	*2	
F.5.9.1	0691	MON2 voltage/current output switching		1/1	1	Disabled	●/●	●	●	*2	
F.5.9.2	0692	MON2 output gradient characteristic	0:Negative inclination (downward slope) 1:Positive inclination (upward slope)	1/1	1	Enabled	●/●	●	●	*2	
F.5.9.3	0693	MON2 bias adjustment	-10.0~100.0%	0.1/0.1	0.0	Enabled	●/●	●	●	*2	

This parameter moves to a fundamental parameter.

*1: For the adjustment range, see the table on page K-34.

*2: For details, refer to Instruction Manual (E6581341) specified in Section 6.36.

[25] Operation panel parameters [1/3] **■** sensorless vector/vector with sensor (: Effective, - : Ineffective, - : Ineffective)

Title	Commu- cation No.	F-function	Adjustment range	Minimum setting unit (Panel/Communi- cation)	Default setting	Write during running	Vector control	PM control	Vf/Constant	Reference
F 700	0700	Parameter write protect selection	0:Permit 1:Prohibit	1/1	0	Enabled	●/●	●	●	6.31.1
F 701	0701	Current/voltage unit selection	0:0% 1:A (ampere)V (volt)	1/1	0	Enabled	●/●	●	●	5.15
F 702	0702	Frequency free unit display magnification	0.00~0.F, 0.01~200.0	0.01/0.01	0.00	Enabled	●/●	●	●	6.31.2
F 703	0703	Frequency free unit conversion selection	0:All frequencies display free unit conversion 1:PID frequencies free unit conversion	1/1	0	Enabled	●/●	●	●	6.31.2
F 705	0705	Free unit display gradient characteristic	0:Negative inclination (downward slope) 1:Positive inclination (upward slope)	1/1	1	Enabled	●/●	●	●	6.31.2
F 706	0706	Free unit display bias	0.00~F Hz	0.01/0.01	0.00	Enabled	●/●	●	●	6.31.2
F 707	0707	Changing step selection 1	0.00:Disabled, 0.01~F Hz	0.01/0.01	0.00	Enabled	●/●	●	●	6.31.3
F 708	0708	Changing step selection 2	0:Disabled, 1~255	1/1	0	Enabled	●/●	●	●	6.31.3
F 709	0709	Standard monitor hold function	0:Real time 1:Peak hold 2:Minimum hold	1/1	0	Enabled	●/●	●	●	8.3
F 710	0710	Standard monitor display selection	0~73 *1	1/1	0	Enabled	●/●	●	●	8.3
F 711	0711	Status monitor 1 display selection	Ditto	1/1	1	Enabled	●/●	●	●	8.3
F 712	0712	Status monitor 2 display selection	Ditto	1/1	2	Enabled	●/●	●	●	8.3
F 713	0713	Status monitor 3 display selection	Ditto	1/1	3	Enabled	●/●	●	●	8.3
F 714	0714	Status monitor 4 display selection	Ditto	1/1	4	Enabled	●/●	●	●	8.3
F 721	0721	Operation panel stop pattern selection	0:Deceleration stop 1:Coast stop	1/1	0	Enabled	●/●	●	●	6.31.5
F 730	0730	Operation panel frequency setting prohibition selection	0:Permit 1:Prohibit	1/1	0	Enabled	●/●	●	●	6.31.1
F 734	0734	Operation panel emergency stop operation prohibition selection	0:Permit 1:Prohibit	1/1	0	Enabled	●/●	●	●	6.31.1
F 735	0735	Operation panel reset operation prohibition selection	0:Permit 1:Prohibit	1/1	0	Enabled	●/●	●	●	6.31.1
F 736	0736	Prohibition of change of $\underline{C} \underline{P} \underline{D} \underline{P} / \underline{F} \underline{P} \underline{D} \underline{P}$ during operation	0:Permit 1:Prohibit	1/1	1	Enabled	●/●	●	●	6.31.1
F 737	0737	All key operation prohibition	0:Permit 1:Prohibit	1/1	0	Enabled	●/●	●	●	6.31.1

■ This parameter moves to a fundamental parameter.

*1: → For the adjustment range, see the table on page K-34.



[25] Operation panel parameters [2/3] **Sensorless vector/vector with sensor (:Effective, -:Ineffective)**

Title	Communication No.	Function	Adjustment range	Minimum setting unit (Panel/Communication)	Default setting	Write during running	Vector control	PM control	Vf/Constant	Reference
F 740	0740	Trace selection	0: Deselect 1: At tripping 2: At triggering	1/1	1	Enabled	●/●	●	●	6.32
F 741	0741	Trace cycle	0: 4ms 1: 20ms 2: 100ms 3: 1s 4: 10s	1/1	2	Enabled	●/●	●	●	6.32
F 742	0742	Trace data 1	0~49	1/1	0	Enabled	●/●	●	●	6.32
F 743	0743	Trace data 2	0~49	1/1	1	Enabled	●/●	●	●	6.32
F 744	0744	Trace data 3	0~49	1/1	2	Enabled	●/●	●	●	6.32
F 745	0745	Trace data 4	0~49	1/1	3	Enabled	●/●	●	●	6.32
F 746	0746	Integrating wattmeter retention selection	00: Disabled 1: Enabled	1/1	1	Enabled	●/●	●	●	6.33
F 749	0749	Integrating wattmeter display unit selection	0: Quick mode/standard setting mode switching 1: 1=10kWh 2: 1=100kWh 3: 1=1000kWh 4: 1=10000kWh	1/1	*2	Enabled	●/●	●	●	6.33
F 750	0750	EASY key function selection	0: Quick mode/standard setting mode switching 1: Shortcut key: Pressing for 2 sec. to record the parameter, pressing normally to jump to recorded parameter (first jump to the 1st history) 2: Local/remote key: Local by ON 3: Monitor peak minimum hold trigger	1/1	0	Disabled	●/●	●	●	5.22
F 751	0751	Quick registration parameter 1	0~999 *1	1/1	40 (AU4)	Enabled	●/●	●	●	5.22
F 752	0752	Quick registration parameter 2	0~999 *1	1/1	15 (pt)	Enabled	●/●	●	●	5.22
F 753	0753	Quick registration parameter 3	0~999 *1	1/1	11 (FH)	Enabled	●/●	●	●	5.22
F 754	0754	Quick registration parameter 4	0~999 *1	1/1	9 (ACC)	Enabled	●/●	●	●	5.22

*1: The communication number of the parameter is used for this setting.

*2: Default values vary depending on the capacity. → See the table of K-41.

[25] Operation panel parameters [3/3] Sensorless vector/vector with sensor (.:Effective, -:Ineffective, -:Ineffective)

Title	Communication No.	F-function	Adjustment range	Minimum setting unit (Panel/Communication)	Default setting	Write during running	Vector control	PM control	Vf/Constant	Reference
F 755	0755	Quick registration parameter 5	0~999 *1	1/1	10 (dEC)	Enabled	•/•	•	•	5.22
F 756	0756	Quick registration parameter 6	0~999 *1	1/1	600 (Hz)	Enabled	•/•	•	•	5.22
F 757	0757	Quick registration parameter 7	0~999 *1	1/1	6 (FM)	Enabled	•/•	•	•	5.22
F 758	0758	Quick registration parameter 8	0~999 *1	1/1	999	Enabled	•/•	•	•	5.22
F 759	0759	Quick registration parameter 9	0~999 *1	1/1	999	Enabled	•/•	•	•	5.22
F 760	0760	Quick registration parameter 10	0~999 *1	1/1	999	Enabled	•/•	•	•	5.22
F 761	0761	Quick registration parameter 11	0~999 *1	1/1	999	Enabled	•/•	•	•	5.22
F 762	0762	Quick registration parameter 12	0~999 *1	1/1	999	Enabled	•/•	•	•	5.22
F 763	0763	Quick registration parameter 13	0~999 *1	1/1	999	Enabled	•/•	•	•	5.22
F 764	0764	Quick registration parameter 14	0~999 *1	1/1	999	Enabled	•/•	•	•	5.22
F 765	0765	Quick registration parameter 15	0~999 *1	1/1	999	Enabled	•/•	•	•	5.22
F 766	0766	Quick registration parameter 16	0~999 *1	1/1	999	Enabled	•/•	•	•	5.22
F 767	0767	Quick registration parameter 17	0~999 *1	1/1	999	Enabled	•/•	•	•	5.22
F 768	0768	Quick registration parameter 18	0~999 *1	1/1	999	Enabled	•/•	•	•	5.22
F 769	0769	Quick registration parameter 19	0~999 *1	1/1	999	Enabled	•/•	•	•	5.22
F 770	0770	Quick registration parameter 20	0~999 *1	1/1	999	Enabled	•/•	•	•	5.22
F 771	0771	Quick registration parameter 21	0~999 *1	1/1	999	Enabled	•/•	•	•	5.22
F 772	0772	Quick registration parameter 22	0~999 *1	1/1	999	Enabled	•/•	•	•	5.22
F 773	0773	Quick registration parameter 23	0~999 *1	1/1	999	Enabled	•/•	•	•	5.22
F 774	0774	Quick registration parameter 24	0~999 *1	1/1	999	Enabled	•/•	•	•	5.22
F 775	0775	Quick registration parameter 25	0~999 *1	1/1	999	Enabled	•/•	•	•	5.22
F 776	0776	Quick registration parameter 26	0~999 *1	1/1	999	Enabled	•/•	•	•	5.22
F 777	0777	Quick registration parameter 27	0~999 *1	1/1	999	Enabled	•/•	•	•	5.22
F 778	0778	Quick registration parameter 28	0~999 *1	1/1	999	Enabled	•/•	•	•	5.22
F 779	0779	Quick registration parameter 29	0~999 *1	1/1	999	Enabled	•/•	•	•	5.22
F 780	0780	Quick registration parameter 30	0~999 *1	1/1	999	Enabled	•/•	•	•	5.22
F 781	0781	Quick registration parameter 31	0~999 *1	1/1	999	Enabled	•/•	•	•	5.22
F 782	0782	Quick registration parameter 32	0~999 *1	1/1	50 (PSEL)	Enabled	•/•	•	•	5.22

*1: The communication number of the parameter is used for this setting.



[26] Communication function [1/4] Sensorless vector/vector with sensor (:Effective, -:Ineffective, -:Ineffective)

Title	Communication No.	Function	Adjustment range	Minimum setting unit (Panel/Communication)	Default setting	Write during running	Vector control	PM control	Vf/Constant	Reference
F800	0800	Communication speed (2-wire RS485)	0:9600 bps 1:19200 bps 2:38400 bps	1/1	1	Enabled	●/●	●	●	6. 34. 1
F801	0801	Parity (common to 2-wire RS485 and 4-wire RS485)	0:Non parity 1:Even parity, 2:Odd parity	1/1	1	Enabled	●/●	●	●	6. 34. 1
F802	0802	Inverter number (common)	0~247	1/1	0	Enabled	●/●	●	●	6. 34. 1
F803	0803	Communications time-out time (common to 2-wire RS485 and 4-wire RS485)	0:OFF, 1~100 sec.	1/1	0	Enabled	●/●	●	●	6. 34. 1
F804	0804	Communications time-out action (common to 2-wire RS485 and 4-wire RS485)	0~8	1/1	8	Enabled	●/●	●	●	6. 34. 1
F805	0805	Send waiting time (2-wire RS485)	0.00:Default, 0.01~2.00 sec. 0:Slave (issues a 0Hz command if something goes wrong with the master) 1:Slave (continues operation if something goes wrong with the master) 2:Slave (trips for emergency stop if something goes wrong with the master) 3:Master (sends a frequency command) 4:Master (sends an output frequency) 5. - 6. -	0.01/0.01	0.00	Enabled	●/●	●	●	6. 34. 1
F807	0807	Protocol selection (2-wire RS485)	0:TOSHIBA 1:MODBUS	1/1	0	Enabled	●/●	●	●	6. 34. 1
F810	0810	Frequency point selection	0:Disabled 1:2-wire RS485 2:4-wire RS485 3:Communication add option	1/1	0	Enabled	●/●	●	●	6. 34. 1
F811	0811	Point 1 setting	0~100%	1/1	0	Enabled*2	●/●	●	●	6. 34. 1
F812	0812	Point 1 frequency	0.0~F Hz	0.1/0.01	0.0	Enabled*2	●/●	●	●	6. 34. 1
F813	0813	Point 2 setting	0~100%	1/1	100	Enabled*2	●/●	●	●	6. 34. 1
F814	0814	Point 2 frequency	0.0~F Hz	0.1/0.01	*1	Enabled*2	●/●	●	●	6. 34. 1
F820	0820	Communication speed (4-wire RS485)	0:9600 bps 1:19200 bps 2:38400 bps	1/1	1	Enabled	●/●	●	●	6. 34. 1
F825	0825	Send waiting time (4-wire RS485)	0.00:Default, 0.01~2.00 sec.	0.01/0.01	0.00	Enabled	●/●	●	●	6. 34. 1

*1: Inverter with a model number ending with -WN: 60.0 -VFP: 50.0

*2: Effective when a command value is sent by communication.

[26] Communication function [2/4] Sensorless vector/vector with sensor (: Effective, - : Ineffective, -| : Ineffective)

Title	Communication No.	F-function	Adjustment range	Minimum setting unit (Panel/Communication)	Default setting	Write during running	Vector control	PM control	Vf/Constant	Reference
F825	0826	Inverter-to-inverter communication setting (4-wire RS485)	0:Slave (issues a 0Hz command if something goes wrong with the master) 1:Slave (continues operation if something goes wrong with the master) 2:Slave (trips for emergency stop if something goes wrong with the master) 3:Master (sends a frequency command) 4:Master (sends an output frequency) 5: - 6: -	1/1	0	Enabled	●●	●	●	6. 34. 1
F829	0829	Protocol selection (4-wire RS485)	0:TOSHIBA 1:MODBUS	1/1	0	Enabled	●●	●	●	6. 34. 1
F830	0830	Communication option (DeviceNet/PROFIBUS) setting 1	0~7	1/1	0	Enabled	●●	●	●	*1
F831	0831	Communication option (DeviceNet/PROFIBUS) setting 2	0000~FFFF	1/1	0000	Enabled	●●	●	●	*1
F832	0832	Communication option (DeviceNet/PROFIBUS) setting 3	0000~FFFF	1/1	0000	Enabled	●●	●	●	*1
F833	0833	Communication option (DeviceNet/PROFIBUS) setting 4	0000~FFFF	1/1	0000	Enabled	●●	●	●	*1
F834	0834	Communication option (DeviceNet/PROFIBUS) setting 5	0000~FFFF	1/1	0000	Enabled	●●	●	●	*1
F835	0835	Communication option (DeviceNet/PROFIBUS) setting 6	0000~FFFF	1/1	0000	Enabled	●●	●	●	*1
F836	0836	Communication option (DeviceNet/PROFIBUS) setting 7	0000~FFFF	1/1	0000	Enabled	●●	●	●	*1
F841	0841	Communication option (DeviceNet/PROFIBUS) setting 8	0000~FFFF	1/1	0000	Enabled	●●	●	●	*1
F842	0842	Communication option (DeviceNet/PROFIBUS) setting 9	0000~FFFF	1/1	0000	Enabled	●●	●	●	*1
F843	0843	Communication option (DeviceNet/PROFIBUS) setting 10	0000~FFFF	1/1	0000	Enabled	●●	●	●	*1
F844	0844	Communication option (DeviceNet/PROFIBUS) setting 11	0000~FFFF	1/1	0000	Enabled	●●	●	●	*1

*1: ⇨ For details, refer to Instruction Manual (E6581281, E6581343) specified in Section 6.36.

[26] Communication function [3/4] **Sensorless vector/vector with sensor (:Effective, -:Ineffective)**

Title	Communication No.	Function	Adjustment range	Minimum setting unit (Panel/Communication)	Default setting	Write during running	Vector control	PM control	Vf/Constant	Reference
<i>F B 4 5</i>	0845	Communication option (DeviceNet/PROFIBUS) setting 12	0000~F F F F	1/1	0000	Enabled	●/●	●	●	*1
<i>F B 4 6</i>	0846	Communication option (DeviceNet/PROFIBUS) setting 13	0000~F F F F	1/1	0000	Enabled	●/●	●	●	*1
<i>F B 5 0</i>	0850	Disconnection detection extended time	0.0~100.0 sec. 0:Inverter stop, communication command, frequency mode open (by <i>L H B 4, F H 0 d</i>) 1:None (continued operation) 2:Deceleration stop 3:Coast stop 4:Network error (<i>E r r B</i> trip) 5:Preset speed operation (by <i>F B 5 2</i> setting)	0.1/0.1	0.0	Enabled	●/●	●	●	*1
<i>F B 5 1</i>	0851	Inverter operation at disconnection	0:None 1~15:Preset speed operation (by parameter setting)	1/1	0	Enabled	●/●	●	●	*1
<i>F B 5 2</i>	0852	Preset speed operation selection	0~255	1/1	0	Enabled	●/●	●	●	*2
<i>F B 5 3</i>	0853	Communication option station address monitor	0~255	1/1	0	Enabled	●/●	●	●	*2
<i>F B 5 4</i>	0854	Communication option speed switch monitor DeviceNet/CC-Link	0~255	1/1	0	Enabled	●/●	●	●	*2
<i>F B 5 5</i>	0856	Number of motor poles for communication	1:2 poles 2:4 poles 3:6 poles 4:8 poles 5:10 poles 6:12 poles 7:14 poles 8:16 poles	1/1	2	Enabled	●/●	●	●	*2

*1: ⇒ For details, refer to Instruction Manual (E6581281, E6581343) specified in Section 6.36.

*2: ⇒ For details, refer to Instruction Manual (E6581281, E6581343, E6581288) specified in Section 6.36.

[26] Communication function [4/4] Sensorless vector/vector with sensor (: Effective, - : Ineffective, - : Ineffective)

Title	Communication No.	Function	Adjustment range	Minimum setting unit (Panel/Communication)	Default setting	Write during running	Vector control	PM control	Vf/Constant	Reference
F β 7 $\bar{0}$	0870	Block write data 1	0:Disabled 1:Command information 1 2:Command information 2 3:Frequency command 4:terminal board output data 5:Communication analog data 6:Rotational speed command	1/1	0	Enabled	●/●	●	●	6. 34. 1
F β 7 $\bar{1}$	0871	Block write data 2	Ditto	1/1	0	Enabled	●/●	●	●	6. 34. 1
F β 7 $\bar{5}$	0875	Block read data 1	0:Deselect 1:Status information 2:Output frequency 3:Output current 4:Output voltage 5:Alarm information 6:PID feedback value 7:Input terminal board monitor 8:Output terminal board monitor 9:V/I terminal board monitor 10:RR/S4 terminal board monitor 11:RX terminal board monitor 12:Input voltage (DC detection) 13:Speed feedback frequency 14:Torque 15:MY monitor 1 16:MY monitor 2 17:MY monitor 3 18:MY monitor 4 19:Free notes 20:Rotational speed	1/1	0	Enabled	●/●	●	●	6. 34. 1
F β 7 $\bar{6}$	0876	Block read data 2	Ditto	1/1	0	Enabled	●/●	●	●	6. 34. 1
F β 7 $\bar{7}$	0877	Block read data 3	Ditto	1/1	0	Enabled	●/●	●	●	6. 34. 1
F β 7 $\bar{8}$	0878	Block read data 4	Ditto	1/1	0	Enabled	●/●	●	●	6. 34. 1
F β 7 $\bar{9}$	0879	Block read data 5	Ditto	1/1	0	Enabled	●/●	●	●	6. 34. 1
F β 8 $\bar{0}$	0880	Free notes	0~FFF	1/1	0	Enabled	●/●	●	●	6. 34. 1
F β 9 $\bar{9}$	0899	Network option reset setting	0:None 1:Reset option circuit board and inverter	1/1	0	Disabled	●/●	●	●	*1

*1: ⇒ For details, refer to Instruction Manual (E6581281) specified in Section 6.36.

[27] My function [1/5]	Sensorless vector/vector with sensor (:Effective, -:Ineffective)								
Title	Communication No.	Function	Adjustment range	Minimum setting unit (Panel/Communication)	Default setting	Write during running	Vector control	PM control	Reference
		Input terminal function number 0: Deselect 1: F terminal 2: R terminal 3: - 4: RES terminal 5: S1 terminal 6: S2 terminal 7: S3 terminal 8: RR/S4 terminal 9: L1 terminal 10: L2 terminal 11: L3 terminal 12: L4 terminal 13: L5 terminal 14: L6 terminal 15: L7 terminal 16: L8 terminal 17: B12 terminal 18: B13 terminal 19: B14 terminal 20: B15 terminal 21: Virtual input terminal 1 22: Virtual input terminal 2 23: Virtual input terminal 3 24: Virtual input terminal 4 25-32: Internal terminal 1~8 918-934: MY function number 1000~1255: Output selection number 2000~2099: FD00~FD99 3000~3099: FE00~FE99			0	Disabled	●/●	●	*1
F 9 0 0	0900	Input function target 11		1/1	0	Disabled	●/●	●	*1

*1: ⇒ For details, refer to Instruction Manual (E6581335) specified in Section 6.36.

② sensorless vector/vector with sensor (.:Effective, -:Ineffective, -/Ineffective)

Title	Communi- cation No.	F-function	Adjustment range	Minimum setting unit (Panel/Communi- cation)	Default setting	Write during running	Vector control	PM control	W/Const	Reference
<i>F 9 0 1</i>	0901	Input function command 12	0:NOP (not operation) 1:ST (move) 2:STN 3:AND (logical product) 4:ANDN 5:OR (logical sum) 6:ORN 7:EQ (equal) 8:NE (not equal) 9:GT (greater than) 10:GE (greater or equal) 11:LT (less than) 12:LE (less or equal) 13:ASUB (absolute) 14:ON (on delay timer) 15:OFF (off delay timer) 16:COUNTER 1 (counter 1) 17:COUNTER 2 (counter 2) 18:HOLD (hold) 19:SET (set) 20:RESET (reset)	1/1	0	Disabled	●/●	●	●	*1
<i>F 9 0 2</i>	0902	Input function target 12	Same as <i>F 9 0 1</i>	1/1	0	Disabled	●/●	●	●	*1
<i>F 9 0 3</i>	0903	Input function command 13	Same as <i>F 9 0 1</i>	1/1	0	Disabled	●/●	●	●	*1
<i>F 9 0 4</i>	0904	Input function target 13	Same as <i>F 9 0 1</i>	1/1	0	Disabled	●/●	●	●	*1
<i>F 9 0 5</i>	0905	Output function assigned object 1	Same as <i>F 9 0 1</i>	1/1	0	Disabled	●/●	●	●	*1
<i>F 9 0 6</i>	0906	Input function target 21	Same as <i>F 9 0 1</i>	1/1	0	Disabled	●/●	●	●	*1
<i>F 9 0 7</i>	0907	Input function command 22	Same as <i>F 9 0 1</i>	1/1	0	Disabled	●/●	●	●	*1
<i>F 9 0 8</i>	0908	Input function target 22	Same as <i>F 9 0 1</i>	1/1	0	Disabled	●/●	●	●	*1
<i>F 9 0 9</i>	0909	Input function command 23	Same as <i>F 9 0 1</i>	1/1	0	Disabled	●/●	●	●	*1
<i>F 9 1 0</i>	0910	Input function target 23	Same as <i>F 9 0 1</i>	1/1	0	Disabled	●/●	●	●	*1
<i>F 9 1 1</i>	0911	Output function assigned object 2	Same as <i>F 9 0 1</i>	1/1	0	Disabled	●/●	●	●	*1
<i>F 9 1 2</i>	0912	Input function target 31	Same as <i>F 9 0 1</i>	1/1	0	Disabled	●/●	●	●	*1
<i>F 9 1 3</i>	0913	Input function command 32	Same as <i>F 9 0 1</i>	1/1	0	Disabled	●/●	●	●	*1

*1: ⇒ For details, refer to Instruction Manual (E6581335) specified in Section 6.36.

11

[27] My function [3/5] Sensorless vector/vector with sensor (: Effective, -: Ineffective)

Title	Communi- cation No.	Function	Adjustment range	Minimum setting unit (Panel/Communi- cation)	Default setting	Write during running	Vector control	PM control	VfConst	Reference
F ₉ 14	0914	Input function target 32	Same as F ₉ 00	1/1	0	Disabled	*/	•	•	*1
F ₉ 15	0915	Input function command 33	Same as F ₉ 01	1/1	0	Disabled	*/	•	•	*1
F ₉ 16	0916	Input function target 33	Same as F ₉ 00	1/1	0	Disabled	*/	•	•	*1
F ₉ 17	0917	Output function assigned object 3	Same as F ₉ 00	1/1	0	Disabled	*/	•	•	*1
F ₉ 18	0918	My output percent data 1	0.00~200.0%	0.01/0.01	0.00	Enabled	*/	•	•	*1
F ₉ 19	0919	My output percent data 2	0.00~200.0%	0.01/0.01	0.00	Enabled	*/	•	•	*1
F ₉ 20	0920	My output percent data 3	0.00~200.0%	0.01/0.01	0.00	Enabled	*/	•	•	*1
F ₉ 21	0921	My output percent data 4	0.00~200.0%	0.01/0.01	0.00	Enabled	*/	•	•	*1
F ₉ 22	0922	My output percent data 5	0.00~200.0%	0.01/0.01	0.00	Enabled	*/	•	•	*1
F ₉ 23	0923	My output frequency data 1	0.00~500.0Hz	0.1/0.1	0.0	Enabled	*/	•	•	*1
F ₉ 24	0924	My output frequency data 2	0.00~500.0Hz	0.1/0.1	0.0	Enabled	*/	•	•	*1
F ₉ 25	0925	My output frequency data 3	0.00~500.0Hz	0.1/0.1	0.0	Enabled	*/	•	•	*1
F ₉ 26	0926	My output frequency data 4	0.00~500.0Hz	0.1/0.1	0.0	Enabled	*/	•	•	*1
F ₉ 27	0927	My output frequency data 5	0.00~500.0Hz	0.1/0.1	0.0	Enabled	*/	•	•	*1
F ₉ 28	0928	My output time data 1	0.01~600.0sec	0.01/0.01	0.01	Enabled	*/	•	•	*1
F ₉ 29	0929	My output time data 2	0.01~600.0sec	0.01/0.01	0.01	Enabled	*/	•	•	*1
F ₉ 30	0930	My output time data 3	0.01~600.0sec	0.01/0.01	0.01	Enabled	*/	•	•	*1
F ₉ 31	0931	My output time data 4	0.01~600.0sec	0.01/0.01	0.01	Enabled	*/	•	•	*1
F ₉ 32	0932	My output time data 5	0.01~600.0sec	0.01/0.01	0.01	Enabled	*/	•	•	*1
F ₉ 33	0933	No. of times of My output data 1	0~9999 times	1/1	0	Enabled	*/	•	•	*1
F ₉ 34	0934	No. of times of My output data 2	0~9999 times	1/1	0	Enabled	*/	•	•	*1
F ₉ 35	0935	Input function target 41	Same as F ₉ 00	1/1	0	Enabled	*/	•	•	*1
F ₉ 36	0936	Input function command 42	Same as F ₉ 01	1/1	0	Enabled	*/	•	•	*1
F ₉ 37	0937	Input function target 42	Same as F ₉ 00	1/1	0	Enabled	*/	•	•	*1
F ₉ 38	0938	Input function command 43	Same as F ₉ 01	1/1	0	Enabled	*/	•	•	*1
F ₉ 39	0939	Input function target 43	Same as F ₉ 00	1/1	0	Enabled	*/	•	•	*1
F ₉ 40	0940	Output function assigned object 4	Same as F ₉ 00	1/1	0	Enabled	*/	•	•	*1
F ₉ 41	0941	Input function target 51	Same as F ₉ 00	1/1	0	Enabled	*/	•	•	*1
F ₉ 42	0942	Input function command 52	Same as F ₉ 01	1/1	0	Enabled	*/	•	•	*1
F ₉ 43	0943	Input function target 52	Same as F ₉ 00	1/1	0	Enabled	*/	•	•	*1
F ₉ 44	0944	Input function command 53	Same as F ₉ 01	1/1	0	Enabled	*/	•	•	*1
F ₉ 45	0945	Input function target 53	Same as F ₉ 00	1/1	0	Enabled	*/	•	•	*1
F ₉ 46	0946	Output function assigned object 5	Same as F ₉ 00	1/1	0	Enabled	*/	•	•	*1

*1: ⇒ For details refer to the Instruction Manual (E6581335) for this parameter.

Sensorless vector/vector with sensor (.:Effective, -:Ineffective, -|:Ineffective)

Title	Communication No.	Function	Adjustment range	Minimum setting unit (Parameter/Communication)	Default setting	Write during running	Vector control	PM control	Vf Constant	Reference
F.9.4.7	0947	Output function target 61	Same as F.9.0.0	1/1	0	Enabled	•/•	•	•	*1
F.9.4.8	0948	Input function command 62	Same as F.9.0.1	1/1	0	Enabled	•/•	•	•	*1
F.9.4.9	0949	Input function target 62	Same as F.9.0.0	1/1	0	Enabled	•/•	•	•	*1
F.9.5.0	0950	Input function command 63	Same as F.9.0.1	1/1	0	Enabled	•/•	•	•	*1
F.9.5.1	0951	Input function target 63	Same as F.9.0.0	1/1	0	Enabled	•/•	•	•	*1
F.9.5.2	0952	Output function assigned object 6	Same as F.9.0.0	1/1	0	Enabled	•/•	•	•	*1
F.9.5.3	0953	Input function target 71	Same as F.9.0.0	1/1	0	Enabled	•/•	•	•	*1
F.9.5.4	0954	Input function command 72	Same as F.9.0.1	1/1	0	Enabled	•/•	•	•	*1
F.9.5.5	0955	Input function target 72	Same as F.9.0.0	1/1	0	Enabled	•/•	•	•	*1
F.9.5.6	0956	Input function command 73	Same as F.9.0.1	1/1	0	Enabled	•/•	•	•	*1
F.9.5.7	0957	Input function target 73	Same as F.9.0.0	1/1	0	Enabled	•/•	•	•	*1
F.9.5.8	0958	Output function assigned object 7	Same as F.9.0.0	1/1	0	Enabled	•/•	•	•	*1
F.9.5.9	0959	Analog input function target 11	0:Disabled 1:V/ / 2:RR/SA 3:RX 4:Optional AI1+, Optional AI1- 5:Optional AI2	1/1	0	Enabled	•/•	•	•	*1
F.9.6.1	0961	Analog function assigned object 11	0:Disabled 1:Acceleration 2:Upper limit frequency (UL) 3:Acceleration multiplication factor 4:Deceleration multiplication factor 5:Manual torque boost (wb) 6:OC stall (F.6.0.1) 7:Thermal protection (LHR) 8:Speed loop P gain (F.4.6.0) 9:Drooping gain (F.3.2.0) 10:PID P gain (F.3.6.2)	1/1	0	Disabled	•/•	•	•	*1

*1: ⇒ For details, refer to Instruction Manual (E6581335) specified in Section 6.36.

[27] My function [5/5] **Sensorless vector/vector with sensor (:Effective, -:Ineffective)**

Title	Commu- nication No.	Function	Adjustment range	Minimum setting unit (Panel/Communi- cation)	Default setting	Write during running	Vector control	PM control	VfConst	Reference
F 5 5 2	0962	Analog input function target 21	0:Disabled 1:V/I/I 2:RR/S4 3:RX 4:Optional AI1+, Optional AI1- 5:Optional AI2	1/1	0	Enabled	●/●	●	●	*1
F 5 5 4	0964	Analog function assigned object 21	0-10	1/1	0	Disabled	●/●	●	●	*1
F 5 5 5	0965	Monitor output function target 11	2000-2099:FD00-FD99 3000-3099:FE00-FE99	1/1	2000	Enabled	●/●	●	●	*1
F 5 5 6	0966	Monitor output function command 11	0:Normal monitor 1:Max. value 2:Min. value	1/1	0	Enabled	●/●	●	●	*1
F 5 5 7	0967	Monitor output function target 21	2000-2099:FD00-FD99 3000-3099:FE00-FE99	1/1	2000	Enabled	●/●	●	●	*1
F 5 5 8	0968	Monitor output function command 21	0:Normal monitor 1:Max. value 2:Min. value	1/1	0	Enabled	●/●	●	●	*1
F 5 5 9	0969	Monitor output function target 31	2000-2099:FD00-FD99 3000-3099:FE00-FE99	1/1	2000	Enabled	●/●	●	●	*1
F 5 7 0	0970	Monitor output function command 31	0:Normal monitor 1:Max. value 2:Min. value	1/1	0	Enabled	●/●	●	●	*1
F 5 7 1	0971	Monitor output function target 41	2000-2099:FD00-FD99 3000-3099:FE00-FE99	1/1	2000	Enabled	●/●	●	●	*1
F 5 7 2	0972	Monitor output function command 41	0:Normal monitor 1:Max. value 2:Min. value	1/1	0	Enabled	●/●	●	●	*1
F 5 7 3	0973	Virtual input terminal selection 1	0-135 *2	1/1	0	Disabled	●/●	●	●	*1
F 5 7 4	0974	Virtual input terminal selection 2	0-135 *2	1/1	0	Disabled	●/●	●	●	*1
F 5 7 5	0975	Virtual input terminal selection 3	0-135 *2	1/1	0	Disabled	●/●	●	●	*1
F 5 7 6	0976	Virtual input terminal selection 4	0-135 *2	1/1	0	Disabled	●/●	●	●	*1
F 5 7 7	0977	My function selection	0:Disabled 1:My function + permission signal 2:My function always ON	1/1	0	Disabled	●/●	●	●	*1

*1: ⇒ For details, refer to Instruction Manual (E6681335) specified in Section 6. 36.

*2: ⇒ For the adjustment range, see the table on page K-36

[Contents of monitor displays]

Communication No.	Function	Unit (Communication)	Monitor output selection	Trip retention	Meter output selection	Vector control	PM control	V/f	Reference
-	Standard monitor	-	F 7 1 U	when tripped	-	* 1	•	•	
FE00	Trip frequency monitor	0.01Hz	when tripped	when tripped	-	•/•	•	•	
Contents of status monitor display									
FE31	Pattern operation group selection	-	at a pattern operation	○	-	•/•	•	•	
FE32	Number of times to repeat current pattern	1	at a pattern operation	○	-	•/•	•	•	
FE33	Pattern operation - number of preset speeds	1	at a pattern operation	○	-	•/•	•	•	
FE34	Remaining time of current pattern operation	1	at a pattern operation	○	-	•/•	•	•	
FE01	Status (rotation direction)	-	Fixed	○	-	•/•	•	•	
-	Status monitor 1	-	F 7 1 1			* 1			
-	Status monitor 2	-	F 7 1 2			* 1			
-	Status monitor 3	-	F 7 1 3			* 1			
-	Status monitor 4	-	F 7 1 4			* 1			
FE06	Input terminal information	-	Fixed	○	-	•/•	•	•	
-	Input terminal information (optional)	-	Fixed	○	-	•/•	•	•	
FE07	Output terminal information	-	Fixed	○	-	•/•	•	•	
-	Output terminal information (optional)	-	Fixed	○	-	•/•	•	•	
FE08	CPU1 version	1	Fixed	x	-	•/•	•	•	
FE73	CPU2 version	-	Fixed	x	-	•/•	•	•	
FE10	Past trip 1	-	Fixed	x	-	•/•	•	•	
FE11	Past trip 2	-	Fixed	x	-	•/•	•	•	
FE12	Past trip 3	-	Fixed	x	-	•/•	•	•	
FE13	Past trip 4	-	Fixed	x	-	•/•	•	•	
FE79	Part replacement alarm information	-	Fixed	x	-	•/•	•	•	
FE14	Cumulative operation time	1h	Fixed	x	-	•/•	•	•	

*1: Status in a trip may not be held depending on selected function. Refer to next page; ⇨ [Monitor FM/AM/pulse output function selection].

[Monitor FM/AM/pulse output function selection (12)]			Sensorless vector/vector with sensor ●: valid, -: invalid]					
FM/AM/pulse output	Monitor output	Function	Unit (Communication)	Trip retention	Vector control	PM control	V/f	Reference
Option No.	Option No.	Communication No.						
0	FD00	0	FE00	Output frequency	0	●/●	●	●
1	FD02	1	FE02	Frequency command value	0	●/●	●	●
2	FD03	2	FE03	Output current	0	●/●	●	●
3	FD04	3	FE04	Input voltage (DC detection)	0	●/●	●	●
4	FD05	4	FE05	Output voltage	0	●/●	●	●
5	FD15	5	FE15	Compensated frequency	0	●/●	●	●
6	FD16	6	FE16	Speed feedback (real-time value) *1	0	●/●	-	-
7	FD17	7	FE17	Speed feedback (1-second filter) *1	0	-/●	-	-
8	FD18	8	FE18	Torque	0	●/●	●	●*2
9	FD19	9	FE19	Torque command	0	-	-	-
11	FD20	11	FE20	Torque current	0	●/●	-	●*2
12	FD21	12	FE21	Exciting current	0	●/●	-	●*2
13	FD22	13	FE22	PID feedback value	0	●/●	●	●
14	FD23	14	FE23	Motor overload factor (OL2 data)	0	●/●	●	●
15	FD24	15	FE24	Inverter overload factor (OL1 data)	0	●/●	●	●
16	FD25	16	FE25	Regenerative braking resistance	1%	0	●/●	●
17	FD28	17	FE28	overload factor (OL1 data)	1%	0	●/●	5.16
18	FD29	18	FE29	Regenerative braking resistor load factor (% ED)	1%	0	●/●	8.3
19	FD30	19	FE30	Input power	0.01kW	0	●/●	●
23	FE39	23	FE39	Output power	0.01kW	0	●/●	●
24	FE35	24	FE35	Optional A12 input	0.01%	x	●/●	●
25	FE36	25	FE36	RR/S4 input	0.01%	x	●/●	●
26	FE37	26	FE37	V/I/I input	0.01%	x	●/●	●
27	FE38	27	FE38	RX input	0.01%	x	●/●	●
28	FE40	28	FE40	Optional A11 input	0.01%	x	●/●	●
29	FE41	29	FE41	FM output	0.01	x	●/●	●
30	FE51	-	-	AM output	0.01	x	●/●	●
31	FA51 *3	-	-	Fixed output 1	0.01%	x	●/●	●
32	FE50	-	-	Communication data output	1	x	●/●	●
33	FE52	-	-	Fixed output 2	0.01%	x	●/●	●
-	-	-	-	Fixed output 3	0.01%	x	●/●	●
-	-	31	FA65	Communication data output	0.01%	x	●/●	●
-	-	32	FE66	Attached to expansion I/O card 1 CPU version	-	x	●/●	●

*1: Estimated speed is output if there is no PG feedback. If used as pulse input command with PG feedback option, frequency is displayed as in the PG feedback.

*2: Reference data

*3: Communication no. FA51 is used for FM, FA52 for AM, FA53 for MON1 and FA54 for MON2 and pulse output, respectively.

⇒ For details, refer to Section 5.16: [Terminal FM-related parameters]

⇒ For monitor indications, refer to Section 8.3: [Set up values of monitor indication parameters].

[Monitor FM/AM/pulse output function selection (2/2)] Sensorless vector/vector with sensor (●: valid, -: invalid)

Option No.	FM/AM/pulse output Communicati on No.	Monitor output Communicati on No.	Function	Unit (Communicati on)	Trip retention	Vector control	PMI control	V/f	Reference
-	-	33	Attached to expansion I/O card 2 CPU version	-	x	●/●	●	●	
34	FE76	34	Integral input power	Depends on F 7 y g	x	●/●	●	●	
35	FE77	35	Integral output power	Depends on F 7 y g	x	●/●	●	●	
45	0006 *3 0671 *4	-	Gain display	1	-	●/●	●	●	
46	FE60	-	My function monitor 1 (Output of unsigned value)	1	x	●/●	●	●	
47	FE61	-	My function monitor 2 (Output of unsigned value)	1	x	●/●	●	●	
48	FE62	-	My function monitor 3 (Output of signed value) *2	1	x	●/●	●	●	
49	FE63	-	My function monitor 4 (Output of signed value) *2	1	x	●/●	●	●	
50	FD00	50	Signed output frequency *5	0.01Hz	○	●/●	●	●	
51	FD02	51	Signed frequency command value *5	0.01Hz	○	●/●	●	●	
52	FD15	52	Signed compensated frequency *5	0.01Hz	○	●/●	●	●	
53	FD16	53	Signed speed feedback (real-time value) *5	0.01Hz	○	-/●	-	-	5.16
54	FD17	54	Signed speed feedback (1-second filter) *5	0.01Hz	○	-/●	-	-	8.3
55	FD18	55	Signed torque *5	0.01%	○	●/●	●	●	
56	FD19	56	Signed torque command *5	0.01%	○	-	-	-	
58	FD20	58	Signed torque current	0.01%	○	●/●	-	●	*1
59	FD22	59	Signed PID feedback value *5	0.01	○	●/●	●	●	
60	FE37	60	Signed RX input *5	0.01%	x	●/●	●	●	
61	FE38	61	Signed optional AI1 input *5	0.01%	x	●/●	●	●	
62	FE51	-	Signed fixed output 1	-	x	●/●	●	●	
63	FE50	-	Signed fixed output 2	-	x	●/●	●	●	
64	FE52	-	Signed fixed output 3	-	x	●/●	●	●	
-	-	71	Output speed	1min ⁻¹	x	●/●	●	●	
-	-	72	Communication option Reception counter	1	x	●/●	●	●	
-	-	73	Communication option Error counter	1	x	●/●	●	●	

*1: Reference data *2: An absolute value is output for pulse train output of 48 and 49.

*3: Communication no. for FM output *4: Communication no. for AM output

*5: If a negative value is specified, the negative sign "-" is displayed. The negative sign "-" is affixed only to values displayed on the monitor. Keep in mind that no sign is affixed to any values read through a communications device.

⇒ For details, refer to Section 5.16; [Terminal FM-related parameters] ⇒ For monitor indications, refer to Section 8.3; [Set up values of monitor indication parameters].



11

Input terminal function setting (1/2)		Senseless vector/vector with sensor (●: valid, -: invalid)					
Positive logic	Negative logic	Function	Vector control	PM control	V/f	Control mode	Reference
0	1	No function is assigned	●/●	●	●	-	-
2	3	F: Forward run command	●/●	●	●	-	-
4	5	R: Reverse run command	●/●	●	●	-	-
6	7	St: Standby	●/●	●	●	1	-
8	9	RES: Reset	●/●	●	●	2	-
10	11	S1: Preset speed 1	●/●	●	●	●	-
12	13	S2: Preset speed 2	●/●	●	●	●	-
14	15	S3: Preset speed 3	●/●	●	●	●	-
16	17	S4: Preset speed 4	●/●	●	●	●	-
18	19	Jog run	●/●	●	●	●	-
20	21	Emergency stop	●/●	●	●	2	-
22	23	DC braking	●/●	●	●	●	-
24	25	Acceleration/deceleration switching	●/●	●	●	●	-
28	29	V/f switching signal	●/●	●	●	●	-
36	37	PID control O/F selection	●/●	●	●	●	-
46	47	External thermal error	●/●	●	●	●	-
48	49	Communication priority cancel	●/●	●	●	●	-
50	51	Holding of HD operation (stop of three-wire operation)	●/●	●	●	●	-
52	53	PID differentiation/integration reset	●/●	●	●	●	-
54	55	PID forward/reverse switching	●/●	●	●	●	-
56	57	Forced continuous operation	●/●	●	●	●	-
58	59	Specified speed operation	●/●	●	●	●	-
64	65	IMV function RUN signal	●/●	●	●	●	-
66	67	Auto-tuning signal	●/●	●	●	●	-
74	75	Integrating wattmeter display clear	●/●	●	●	●	-
76	77	Trace back trigger signal	●/●	●	●	●	-
86	87	Binary data write	●/●	●	●	●	-
88	89	Up/Down frequency (up)*3	●/●	●	●	●	-
90	91	Up/Down frequency (down)*3	●/●	●	●	●	-
92	93	Up/Down frequency (clear)	●/●	●	●	●	-
98	99	Forward/reverse selection	●/●	●	●	●	-

*1: Valid any time

*2: Independent of Control mode, and all command are valid.

*3: The deceleration/deceleration time depends on the Reference setting, unless switching between acceleration and deceleration is performed.

[Input terminal function setting (2/2)] Sensorless vector/vector with sensor (●: valid, -: invalid)

Positive logic	Negative logic	Function	Vector control	PM control	V/f	$\zeta \pi \sigma d = 1$	$F \sigma \delta = 1$	Reference
100	101	Run/Stop command	●/●	●	●	●	-	
102	103	Commercial power/INV switching	●/●	●	●	●	-	
104	105	Frequency reference priority switching	●/●	●	●	●	-	
106	107	V/f terminal priority	●/●	●	●	●	-	
108	109	Command terminal board priority	●/●	●	●	●	-	7.2.1
110	111	Parameter editing enabling	●/●	●	●	●	-	
122	123	Rapidest deceleration command	●/●	●	●	●	-	
124	125	Preliminary excitation	●/●	●	●	●	-	

[Output terminal function setting (1/3)] Sensorless vector/vector with sensor (●: valid, -: invalid)

Positive logic	Negative logic	Function	Vector control	PM control	V/f	Reference
0	1	LL	●/●	●	●	
2	3	UL	●/●	●	●	
4	5	LOW	●/●	●	●	
6	9	Acceleration/deceleration completion	●/●	●	●	
8	7	Specified speed arrival	●/●	●	●	
10	11	Failure FL (all trip)	●/●	●	●	
12	13	Failure FL (except for EF, OCL, EPHO and OL2)	●/●	●	●	
14	15	Overcurrent pre-alarm	●/●	●	●	
16	17	Inverter overload pre-alarm	●/●	●	●	
18	19	Motor overload pre-alarm	●/●	●	●	
20	21	Overheat pre-alarm	●/●	●	●	
22	23	Overvoltage pre-alarm	●/●	●	●	
24	25	Main circuit undervoltage alarm	●/●	●	●	
26	27	Low current alarm	●/●	●	●	
28	29	Overtorque alarm	●/●	●	●	
30	31	Braking resistor overload pre-alarm	●/●	●	●	
32	33	In emergency stop	●/●	●	●	
34	35	In course of retry	●/●	●	●	
38	39	PID deviation limit	●/●	●	●	
40	41	Run/Stop	●/●	●	●	
42	43	Serious failure (OCA, OCL, EF, phase failure, etc.)	●/●	●	●	
44	45	Light failure (OL, OC1, 2, 3, OP)	●/●	●	●	
46	47	Commercial/INV operation output	●/●	●	●	
48	49	Commercial/INV switching output 2 (for commercial operation output)	●/●	●	●	
50	51	Cooling fan ON/OFF	●/●	●	●	
52	53	In Jog run	●/●	●	●	
54	55	Panel operation/terminal board operation switching	●/●	●	●	
56	57	Cumulative operation time alarm	●/●	●	●	
58	59	PROFIBUS/DeviceNet/CC-Link communication error	●/●	●	●	
60	61	Forward/reverse run	●/●	●	●	
62	63	Ready for operation 1	●/●	●	●	
64	65	Ready for operation 2	●/●	●	●	
70	71	In (pre-)alarm status	●/●	●	●	
76	77	Inverter healthy output	●/●	●	●	
78	79	RS485 communication error	●/●	●	●	

(Output terminal function setting (2/3)) Sensorless vector/vector with sensor (●: valid, ○: invalid)

Positive logic	Negative logic	Function	Vector control	PMI control	V/f	Reference
80	81	Error code output 1 (6-bit output)	●/●	●	●	
82	83	Error code output 2 (6-bit output)	●/●	●	●	
84	85	Error code output 3 (6-bit output)	●/●	●	●	
86	87	Error code output 4 (6-bit output)	●/●	●	●	
88	89	Error code output 5 (6-bit output)	●/●	●	●	
90	91	Error code output 6 (6-bit output)	●/●	●	●	
92	93	Designated data output 1 (7-bit output)	●/●	●	●	
94	95	Designated data output 2 (7-bit output)	●/●	●	●	
96	97	Designated data output 3 (7-bit output)	●/●	●	●	
98	99	Designated data output 4 (7-bit output)	●/●	●	●	
100	101	Designated data output 5 (7-bit output)	●/●	●	●	
102	103	Designated data output 6 (7-bit output)	●/●	●	●	
104	105	Designated data output 7 (7-bit output)	●/●	●	●	
110	111	Positive torque limit	●/●	●	●	
112	113	Negative torque limit	●/●	●	●	
114	115	Output for external rush suppression relay	●/●	●	●	
120	121	L-STOP	●/●	●	●	
128	129	Part replacement alarm	●/●	●	●	
130	131	Overtorque pre-alarm	●/●	●	●	
132	133	Operation frequency command 1/2 selection	●/●	●	●	
134	135	Failure FL (except emergency stop)	●/●	●	●	
136	137	Local/remote switching	●/●	●	●	
138	139	Forced operation (Force)	●/●	●	●	
140	141	Forced operation (Force)	●/●	●	●	
142	143	Undertorque detection	●/●	●	●	
144	145	Frequency command agreement signal (RR/RS4)	●/●	●	●	
146	147	Frequency command agreement signal (VI)	●/●	●	●	
148	149	Frequency command agreement signal (RX)	●/●	●	●	
150	151	PTC alarm detection	●/●	●	●	
152	153	Power removal signal	●/●	●	●	
154	155	V/M/I input wire breakage	●/●	●	●	
222	223	My function output 1	●/●	●	●	
224	225	My function output 2	●/●	●	●	
226	227	My function output 3	●/●	●	●	
228	229	My function output 4	●/●	●	●	
230	231	My function output 5	●/●	●	●	
232	233	My function output 6	●/●	●	●	
234	235	My function output 7	●/●	●	●	
236	237	My function output 8	●/●	●	●	

7.2.2



[Output terminal function setting 3/3] Sensorless vector/vector with sensor (●: valid, -: invalid)

Positive logic	Negative logic	Function	Vector control	PM control	V/f	Reference
238	239	My function output 9	●/●	●	●	7.2.2
240	241	My function output 10	●/●	●	●	
242	243	My function output 11	●/●	●	●	
244	245	My function output 12	●/●	●	●	
246	247	My function output 13	●/●	●	●	
248	249	My function output 14	●/●	●	●	
250	251	My function output 15	●/●	●	●	
252	253	My function output 16	●/●	●	●	
254	255	Always OFF (for terminal signal tests)	●/●	●	●	

Standard default settings classified by inverter model (capacity)

Inverter type	Torque boost F 112 F 113	Base frequency U ₀ F 114	Acdec time F 500F 501	PWM Center frequency F 115	Drainic resistance Pbr	Allowable continuous braking resistance Pbr	Inverter side switching waiting time F 315	Motor rated capacity F 415	Motor rated current F 416	Motor rated rotational speed F 417	Motor constant 1 (torque F 418)	Motor constant 2 (no load current) F 419	Motor constant 3 (leak inductance) F 420	Motor constant 4 (relat slip) F 421	Display unit selection for integral output power F 119
VFFS1-2004PL	8.0	2.30	19.0	12.0	2.00.0	0.12	0.51	0.40	2.0	16.80	1.8	6.1	12.0	6.57	0
VFFS1-2007PL	8.0	2.30	19.0	12.0	2.00.0	0.12	0.51	0.75	3.4	16.90	7.3	5.4	16.0	6.11	0
VFFS1-2015PL	6.0	2.30	19.0	12.0	7.5.0	0.12	0.51	1.50	6.2	16.90	7.1	4.5	7.0	6.11	0
VFFS1-2022PL	6.0	2.30	19.0	12.0	7.5.0	0.12	0.51	2.20	8.9	16.60	5.9	4.1	7.0	6.67	0
VFFS1-2037PL	6.0	2.30	19.0	12.0	4.0.0	0.12	0.67	2.70	14.8	16.90	4.8	3.6	8.0	5.11	1
VFFS1-2055PL	4.0	2.30	19.0	12.0	20.0	0.24	0.87	5.50	27.0	17.30	3.9	3.4	7.0	3.89	1
VFFS1-2075PL	4.0	2.30	19.0	12.0	15.0	0.44	0.87	11.50	28.2	17.30	3.4	3.3	7.0	3.89	1
VFFS1-2110PM	3.0	2.30	19.0	12.0	10.0	0.66	1.07	11.0	40.5	17.30	2.8	2.7	6.0	3.89	1
VFFS1-2150PM	3.0	2.30	19.0	12.0	7.5	0.88	1.07	15.0	54.5	17.30	2.5	2.7	6.0	3.89	1
VFFS1-2165PM	3.0	2.30	30.0	4.0	7.5	0.88	1.37	18.5	68.0	17.30	2.6	2.7	7.0	2.78	1
VFFS1-2230PM	3.0	2.30	30.0	4.0	3.3	1.76	1.37	22.0	80.0	17.30	2.4	2.7	7.0	3.78	1
VFFS1-2300PM	3.0	2.30	30.0	4.0	3.3	1.76	1.37	30.0	108.0	17.30	2.2	2.6	7.0	3.06	1
VFFS1-2370PM	3.0	2.30	30.0	4.0	3.0	2.20	1.37	31.0	108.0	17.30	1.8	2.6	7.0	2.78	2
VFFS1-2450PM	3.0	2.30	30.0	4.0	2.0	2.20	1.37	45.0	150.0	17.30	1.7	2.6	6.0	2.78	2
VFFS1-2550P	3.0	2.30	30.0	2.5	2.0	2.0	1.87	55.0	165.0	17.30	1.6	2.4	7.0	2.50	2
VFFS1-2700P	2.0	2.30	6.00	2.5	1.7	3.40	2.37	71.50	258.0	17.30	1.5	2.8	5.0	1.99	2
VFFS1-2800P	2.0	2.30	6.00	2.5	1.7	3.40	3.37	90.0	305.0	17.30	1.3	2.6	5.0	1.99	2
VFFS1-4007PL	8.0	*2	19.0	12.0	2.00.0	0.12	0.57	0.75	1.1	16.90	7.3	5.4	10.0	6.11	0
VFFS1-4015PL	6.0	*2	19.0	12.0	2.00.0	0.12	0.57	1.50	3.1	16.90	7.1	4.5	6.0	6.11	0
VFFS1-4022PL	6.0	*2	19.0	12.0	2.00.0	0.12	0.57	2.20	4.5	16.80	5.9	4.1	7.0	6.67	0
VFFS1-4037PL	6.0	*2	19.0	12.0	16.0.0	0.12	0.67	3.70	7.4	16.90	4.9	3.6	7.0	5.11	1
VFFS1-4055PL	4.0	*2	19.0	12.0	80.0	0.24	0.87	5.50	10.5	17.30	3.9	3.4	7.0	3.89	1
VFFS1-4075PL	4.0	*2	19.0	12.0	60.0	0.44	0.87	7.50	14.1	17.30	3.4	3.3	7.0	3.89	1
VFFS1-4110PL	4.0	*2	19.0	12.0	40.0	0.66	1.07	11.0	20.3	17.30	2.8	2.7	6.0	3.89	1
VFFS1-4150PL	3.0	*2	19.0	12.0	30.0	0.88	1.07	15.0	27.3	17.30	2.5	2.7	6.0	3.89	1
VFFS1-4165PL	3.0	*2	30.0	4.0	30.0	0.88	1.37	18.5	34.0	17.30	2.6	2.7	7.0	2.78	1
VFFS1-4230PL	3.0	*2	30.0	4.0	15.0	1.76	1.37	22.0	40.0	17.30	2.4	2.7	7.0	3.78	1
VFFS1-4300PL	3.0	*2	30.0	4.0	15.0	1.76	1.37	30.0	54.0	17.30	2.2	2.6	7.0	3.06	1
VFFS1-4370PL	3.0	*2	30.0	4.0	8.0	1.76	1.37	31.0	67.0	17.30	1.8	2.7	7.0	2.78	2
VFFS1-4450PL	3.0	*2	30.0	4.0	8.0	1.76	1.37	45.0	80.0	17.30	1.7	2.6	6.0	2.78	2
VFFS1-4550PL	2.0	*2	30.0	4.0	8.0	1.76	1.37	71.50	298.0	17.30	1.6	2.4	7.0	2.50	2
VFFS1-4750PL	2.0	*2	6.00	2.5	3.7	3.40	1.37	90.0	153.0	17.30	1.5	2.8	5.0	1.99	2
VFFS1-4900PC	2.0	*2	6.00	2.5	3.7	3.40	1.37	110.0	183.0	17.30	1.3	2.6	5.0	1.99	2
VFFS1-4110KPC	2.0	*2	6.00	2.5	3.7	1.40	1.37	110.0	183.0	17.30	1.5	2.7	3.0	4.39	2
VFFS1-4132KPC	2.0	*2	6.00	2.5	3.7	1.40	1.37	132.0	211.0	17.30	1.7	2.0	4.0	1.94	2
VFFS1-4160KPC	1.5	*2	6.00	2.5	3.7	1.40	1.37	160.0	271.0	17.30	1.6	2.0	4.0	1.94	2
VFFS1-4220KPC	1.5	*2	6.00	2.5	1.9	8.70	1.37	220.0	371.0	17.30	0.6	2.0	4.0	1.94	2
VFFS1-4280KPC	1.5	*2	6.00	2.5	1.4	14.00	1.37	250.0	434.0	17.30	0.6	2.0	4.0	1.94	2
VFFS1-4315KPC	1.0	*2	6.00	2.5	1.4	14.00	1.37	315.0	473.0	17.30	0.6	2.0	4.0	1.94	2
VFFS1-4400KPC	1.0	*2	6.00	2.5	0.95	17.80	1.37	400.0	691.0	17.30	0.6	2.0	3.0	1.94	3
VFFS1-4500KPC	0.5	*2	6.00	2.5	0.7	28.00	1.37	500.0	850.0	17.30	0.6	2.0	3.0	1.94	3
VFFS1-4630KPC	0.5	*2	6.00	2.5	0.7	28.00	1.37	630.0	946.0	17.30	0.6	2.0	3.0	1.94	3

*1: Factory default settings when the base frequency (u L) is set at 60Hz (50Hz) *2: Inverter with a model number ending with -WN: 4E0 -WP: 400



12. Specifications

12.1 Models and their standard specifications

1) Standard specifications (small/medium capacity types)

Item		Specification													
Voltage class		200V class													
Applicable motor (kW)	0.4	0.75	1.5	2.2	3.7	5.5	7.5	11	15	18.5	22	30	37	45	
Applicable motor (HP)	0.5	1	2	3	5	7.5	10	15	20	25	30	40	50	60	
Type		VFPS1-													
Form		2004PL	2007PL	2015PL	2022PL	2037PL	2055PL	2075PL	2110PM	2150PM	2185PM	2220PM	2300PM	2370PM	2450PM
Output capacity (kVA) [Note 1]		1.1	1.8	3.0	4.2	6.7	10	13	21	25	29	34	46	55	67
Output current (A) [Note 2]		3.0 (3.0)	4.8 (4.5)	8.0 (8.0)	11 (10.5)	17.5 (16.6)	27.5 (25.0)	33 (33)	54 (49)	66 (64)	75 (66)	88 (75)	120 (88)	144 (120)	176 (140)
Output voltage		Three-phase 200V~240V (The maximum output voltage is equal to the input supply voltage.)													
Overload current rating		120%-1 minute, 135%-2 sec.													
Dynamic braking circuit		Built-in dynamic braking drive circuit													
Dynamic braking resistor		An external braking resistor (optional) ⇒ Rating: Refer to 5.19.													
Voltage-frequency		Three-phase 200~240V-50/60Hz [Note 3]													
Allowable fluctuation		Voltage + 10% - 15% [Note 4] Frequency ±5%													
Protective method		IP20 Enclosed type (JEM1030)										IP00 Open type (JEM1030) [Note 5]			
Cooling method		Forced air-cooled													
Cooling fan noise (dBA)		43	43	43	55	55	56	58	60	60	60	60	64	64	64
Color		RAL7016													
EMC filter		Built-in							Basic filter (Not complies with the European EMC Directive)						
DC reactor		External DC reactor (option)							Built-in						

Item		Specification															
Voltage class		400V class															
Applicable motor (kW)	0.75	1.5	2.2	3.7	5.5	7.5	11	15	18.5	22	30	37	45	55	75		
Applicable motor (HP)	1	2	3	5	7.5	10	15	20	25	30	40	50	60	75	100		
Type		VFPS1-															
Form		4007PL	4015PL	4022PL	4037PL	4055PL	4075PL	4110PL	4150PL	4185PL	4220PL	4300PL	4370PL	4450PL	4550PL	4750PL	
Output capacity (kVA) [Note 1]		1.8	3.1	4.4	8.0	11	13	21	25	31	37	50	60	72	88	122	
Output current (A) [Note 2]		2.3 (2.3)	4.1 (4.0)	5.8 (4.6)	10.5 (8.6)	14.3 (13)	17.6 (17)	27.7 (25)	33 (32)	41 (37)	48 (38)	66 (53)	79 (60)	94 (75)	116 (93)	160 (120)	
Output voltage		Three-phase 380V~480V (The maximum output voltage is equal to the input supply voltage.)															
Overload current rating		120%-1 minute, 135%-2 sec.															
Dynamic braking circuit		Built-in dynamic braking drive circuit															
Dynamic braking resistor		An external braking resistor (optional) ⇒ Rating: Refer to 5.19.															
Voltage-frequency		Three-phase 380~480V-50/60Hz [Note 3]															
Allowable fluctuation		Voltage + 10% - 15% [Note 4] Frequency ±5%															
Protective method		IP20 Enclosed type (JEM1030)										IP00 Open type (JEM1030) [Note 5]					
Cooling method		Forced air-cooled															
Cooling fan noise (dBA)		43	43	43	55	56	56	58	60	60	60	60	64	64	64	64	
Color		RAL7016															
EMC filter		Built-in															
DC reactor		External DC reactor (option)										Built-in					

Note 1: Capacity is calculated at 220V for the 200V models and at 440V for the 400V models.

Note 2: Rated output current when the PWM carrier frequency (parameter f_c) is 4kHz or less.

The values between parentheses refer to rated output currents when set to 12kHz.

⇒ Refer to 1.4.4 "Current reduction curve" for details.

Note 3: If you are using a 200V-15kW or 400V-2.2kW inverter and the ambient temperature is 40°C or more, decrease the PWM carrier frequency to 8kHz. Setting F_{53} to 1 enables you to protect the overload caused by ambient temperature described in page A-23.

An external power supply backup available (optional) (Type: CPS002Z)

Note 4: ±10% when the inverter is used continuously (load of 100%).

Note 5: Inverters, 18.5kW or greater, do not have wiring port covers. They have large openings, but there is no space to bend the external cables inside the unit.

2) Standard specifications (large capacity types) [Note 1]

Item		Specification		
Voltage class		200V class		
Applicable motor (kW)		55	75	90
Applicable motor (HP)		75	100	125
Rating	Type	VFPS1-		
	Form	2550P	2750P	2900P
	Output capacity (kVA) [Note 2]	84	109	137
	Output current (A)	221	285	359
	Output voltage	Three-phase 200V~240V (The maximum output voltage is equal to the input supply voltage.)		
Overload current rating		120%-1 minute, 135%-2 sec.		
Electrical braking	Dynamic braking circuit	Built-in dynamic braking drive circuit		
	Dynamic braking resistor	An external braking resistor (optional) ⇒ Rating: Refer to 5.19.		
Power supply	Voltage-frequency [Note 3]	Three-phase 200~240V-50/60Hz		
	Allowable fluctuation	Voltage + 10% - 15% [Note 4] Frequency ±5%		
Protective method		IP00 Open type (JEM1030) [Note 5]		
Cooling method		Forced air-cooled		
Cooling fan noise (dBA)		61	61	70
Color		RAL7016		
EMC filter		External filter (optional)		
DC reactor		Attached DC reactor		

Item		Specification										
Voltage class		400V class										
Applicable motor (kW)		90	110	132	160	220	250	280	315	400	500	630
Applicable motor (HP)		125	150	200	250	350	400	450	500	600	700	1000
Rating	Type	VFPS1-										
	Form	4900PC	4110KPC	4132KPC	4160KPC	4220KPC	4250KPC	4280KPC	4315KPC	4400KPC	4500KPC	4630KPC
	Output capacity (kVA) [Note 2]	136	164	197	239	325	367	419	469	578	717	905
	Output current (A)	179	215	259	314	427	481	550	616	759	941	1188
	Output voltage	Three-phase 380V~480V (The maximum output voltage is equal to the input supply voltage.)										
Overload current rating		120%-1 minute, 135%-2 sec.										
Electrical braking	Dynamic braking circuit	Built-in dynamic braking drive circuit					External dynamic braking circuit (optional)					
	Dynamic braking resistor	An external braking resistor (optional) ⇒ Rating: Refer to 5.19.										
Power supply	Voltage-frequency [Note 3]	Three-phase 380~480V-50/60Hz			Three-phase 380~440V-50Hz Three-phase 380~480V-60Hz							
	Allowable fluctuation	Voltage + 10% - 15% [Note 4] Frequency ±5%										
Protective method		IP00 Open type (JEM1030) [Note 5]										
Cooling method		Forced air-cooled										
Cooling fan noise (dBA)		61	61	72	73	73	76	76	76	76	76	78
Color		RAL7016										
EMC filter		Built-in										
DC reactor		Attached DC reactor										

Note 1: For 200V-55kW, 400V-90kW or larger model, be sure to install DC reactor.

However, this is unnecessary for DC input specifications.

Note 2: Capacity is calculated at 220V for the 200V models and at 440V for the 400V models.

Note 3: An external power supply backup available (optional) (Type: CSP002Z)

Note 4: ±10% when the inverter is used continuously (load of 100%).

Note 5: Inverters, 18.5kW or greater, do not have wiring port covers. They have large openings, but there is no space to bend the external cables inside the unit.

12

3) Common specification

	Item	Specification
Control specification	Control system	Sinusoidal PWM control
	Output voltage adjustment	Main circuit voltage feedback control. (Switchable between automatic adjustment/fix/control off)
	Output frequency range	Setting between 0.01 to 500Hz. Default max. frequency is set to 0.01 to 60Hz. Maximum frequency adjustment (30 to 500Hz)
	Minimum setting steps of frequency	0.01Hz: operation panel input (60Hz base), 0.02Hz: analog input (60Hz base, 11 bit/0 to 10Vdc)
	Frequency accuracy	Analog input: $\pm 0.2\%$ of the maximum output frequency (at 25 $\pm 10^{\circ}\text{C}$) Digital input: $\pm 0.01\% \pm 0.022\text{Hz}$ of the output frequency
	Voltage/frequency characteristics	V/f constant, square reduction torque control, automatic torque boost, vector calculation control, base frequency adjustment 1 and 2 (25 to 500Hz), V/f 5-point arbitrary setting, torque boost adjustment (0 to 30%), start frequency adjustment (0 to 10Hz), stop frequency adjustment (0 to 30Hz)
	Frequency setting signal	0k to 20mAdc to 20mAdc (possible) to connect to 1 to 10k 0 to 10Vdc (input impedance Zi): 30k 0 to $\pm 10\text{Vdc}$ (Zi): 22k 0 to 20mAdc (Zin: 242)
	Terminal board base frequency	The characteristic can be set arbitrarily by two-point setting. Compliant with 6 types of input; analog input (RR, V/II, RX, RX2), pulse input and binary/BCD input (*RX2, binary/BCD input: optional)
	Frequency jump	3 places. Setting of jump frequency and width.
	Upper and lower limit frequencies	Upper limit frequency: 0 to max. frequency, lower limit frequency: 0 to upper limit frequency
	PWM carrier frequency	200V-45kW or less, adjustable between 1.0 to 16kHz for 400V-75kW or less 200V-55kW or less, adjustable between 2.5 to 8kHz for 400V-90kW or more
	PID control	Adjustment of proportional gain, integral time, differential time and delay filter
	Operation specifications	Acceleration/deceleration time
DC braking		Adjustment of braking start frequency (0 to 120Hz), braking (0 to 100%) and braking time (0 to 20 sec.). With emergency stop braking function and motor shaft fix control function.
Forward run/reverse run [Note 1]		With F-CC closed to forward run, with R-CC closed to reverse run, with both closed to reverse run. With ST-CC opened to coast stop. Emergency stop by panel operation or terminal board.
Jog run [Note 1]		Jog mode, if selected, allows jog operation from the operation panel Jog run operation by terminal board is possible by setting the parameters.
Preset speed operation [Note 1]		By changing the combination of open/close between S1, S2, S3, RR/S4-CC, set frequency + 15-speed operation. Selectable between acceleration/deceleration time, torque limit and V/f by set frequency.
Retry		Capable of restarting after a check of the main circuit elements in case the protective function is activated. Max. 10 times selectable arbitrarily. Waiting time adjustment (0 to 10 sec.)
Soft stall		Automatic load reduction control at overloading. (Default: OFF)
Cooling fan ON/OFF		The cooling fan will be stopped automatically to assure long life when unnecessary.
Operation panel key operation ON/OFF control		Key prohibition selectable between STOP key only, MODE key only, etc. All key operations can be prohibited.
Regenerative power ride-through control		Possible to keep the motor running using its regenerative energy in case of a momentary power failure. (Default: OFF)
Auto-restart operation		Possible to restart the motor in coasting in accordance with its speed and direction. (Default: OFF)
Commercial inverter switching		Possible to switch operation by commercial power source or inverter
Drooping function		When two or more inverters are used to operate a single load, this function prevents load from concentrating on one inverter due to unbalance.
Override function	External input signal adjustment is possible to the operation frequency command value.	
Protective function	Protective function	Stall prevention, current limit, overcurrent, overvoltage, short circuit on the load side, ground fault on the load side [Note 6], undervoltage, momentary power failure (15ms or more), non-stop control at momentary power failure, overload protection, arm overload at starting, overcurrent on the load side at starting, overcurrent and overload at dynamic braking resistance, fan overheat, emergency stop
	Electronic thermal characteristic	Switchable between standard motor/constant torque V/f motor, adjustment of overload protection and stall prevention level.
	Reset	Reset by 1a contact closed (or 1b contact opened), or by operation panel. Or power source OFF/ON. This function is also used to save and clear trip records.

(Continued overleaf)

(Continued)

Item		Specification	
Display function	4-digit and 7-segment LED	Alarms	Stall prevention during operation, overload limit, overload, undervoltage on power source side, DC circuit undervoltage, setting error, in retry, upper limit, lower limit.
		Causes of failures	Overcurrent, overvoltage, fin overheat, short circuit on the load side, ground fault on the load side, inverter overload, arm overcurrent at starting, overcurrent on the load side at starting, EEPROM error, RAM error, ROM error, transmission error, (dynamic braking resistor overcurrent/overload), (emergency stop), (undervoltage), (low current), (overtorque), (motor overload), (output phase failure) The items in the parentheses are selectable.
		Monitoring function	Operation frequency, operation frequency command, forward run/reverse run, output current, DC voltage, output voltage, compensated frequency, terminal board input/output information, CPU version, control EEPROM version, past trip history, cumulative operation time, speed feedback, torque, torque command, torque current, exiting current, PID feedback value, motor overload factor, inverter overload factor, PBR overload factor, PBR load factor, input power, output power, peak output current, peak DC voltage, Motor counter pseudo PG, position pulse, RR input, VI/II input, RX input, RX2 input, FM output, AM output, meter adjustment fix output, flash memory version, main circuit EEPROM version, types of connection option, previous default setting, previous automatic control (AU2)
		Free unit display	Display of optional units other than output frequency (motor speed, line speed, etc), current ampere/% switch, voltage volt/% switch
		Automatic edit function	Searches automatically parameters that are different from the standard default setting parameters. Easy to find changed parameters.
	User default setting	User parameter settings can be saved as default settings. Allows to reset the parameters to the user-defined parameter settings.	
LED	Charge display	Displays main circuit capacitor charging.	
Power Removal safety function		Built-in Power Removal safety function which complies with EN954-1 category 3 and IEC/EN 61508-1 SIL2.	
Input/output terminal input function		Possible to select positive logic or negative logic with programmable input/output terminal function menu. [Note 1] [Note 2] (Default setting: positive logic)	
Sink/source switching		Possible to switch between minus common (CC) and plus common (P24) for control terminal. (Default setting: minus common (CC))	
Output signal	Failure detection signal	1c contact output (250Vac-2A-cos Φ =1, 250Vac-1A-cos Φ =0.4, 30Vdc-1A)	
	Low speed/speed reach signal output [Note 2]	Open collector output (24Vdc, max. 50mA, output impedance: 33	
	Upper/lower limit frequency signal output [Note 2]	Open collector output (24Vdc, max. 50mA, output impedance: 33	
	Output for frequency meter/ Output for ammeter [Note 3]	Analog output. 1mAdc full-scale DC ammeter or 7.5Vdc-1mA voltmeter	
	Pulse train frequency output	Open collector output (24Vdc, max. 50mA)	
Communication function		RS-485 standard 2-channel equipped (connector: modular 8P) CC-Link, DeviceNet and PROFIBUS-DP are optional.	
Environments	Use environments	Indoor use. Altitude: 3000m or less (current reduction necessary if 1000m or more.) Place not exposed to direct sunlight and free of corrosive and explosive gases.	
	Ambient temperature	-10 to +60°C (Remove the upper cover if 40°C or more, max. 60°C) [Note 4]	
	Storage temperature	-25 to +70°C	
	Relative humidity	20 to 93% (free from condensation)	
	Vibration	5.9m/s ² (0.6G) or less (10 to 55Hz) (Compliant with JIS C60068-2-6)	

Note 1: 15 contact input terminals (of which 8 are options) are programmable contact input terminals, and they make it possible to arbitrarily select from about 80 types of signals.

Note 2: Programmable ON/OFF output terminals make it possible to arbitrarily select from about 180 types of signals.

Note 3: Programmable analog output terminals make it possible to arbitrarily select from about 50 types of signals.

Note 4: 200V class 0.4~45kW, 400V class 0.75~75kW: When using inverters where the ambient temperature will rise above 40°C, remove the covers on top of them, or when using them where the ambient temperature will rise above 50°C, remove the covers on top of them and lower the output current.

200V class 55~90kW, 400V class 90~630kW: When using inverters where the ambient temperature will rise above 45°C, operate each inverter at a current lower than the rated one.

Note 5: Inverters, 18.5kW or greater, do not have wiring port covers. They have large openings, but there is no space to bend the external cables inside the unit.

Note 6: This function protects inverters from overcurrent due to output circuit ground fault.

12.2 Outside dimensions and weight

■ Outside dimensions and weight

Voltage class	Applicable motor (kW)	Applicable motor (HP)	Inverter type	Dimensions (mm)										Drawing	Approx. weight (kg)
				W	H	D	W1	H1	W2	H2	H3	H4			
200V	0.4	0.5	VFPS1-2004PL	130	230	152	114	220	-	-	-	-	A	3	
	0.75	1	VFPS1-2007PL												
	1.5	2	VFPS1-2015PL												
	2.2	3	VFPS1-2022PL	155	260	164	138	249	-	-	-	-	B	4	
	3.7	5	VFPS1-2037PL												
	5.5	7.5	VFPS1-2055PL	175	295	164	158	283	-	-	-	-	C	5.5	
	7.5	10	VFPS1-2075PL	210	295	191	190	283	-	-	-	-	D	7.5	
	11	15	VFPS1-2110PM	230	400	191	210	386	-	-	-	-	E	14	
	15	20	VFPS1-2150PM												
	18.5	25	VFPS1-2185PM	240	420	212	206	403	-	-	-	-	F	21	
	22	30	VFPS1-2220PM												
	30	40	VFPS1-2300PM	320	550	242	280	525	-	-	-	-	H	41	
	37	50	VFPS1-2370PM												
	45	60	VFPS1-2450PM												
55	75	VFPS1-2550P													
75	100	VFPS1-2750P	310	680 (920)	370	250	650	320	75	150	30	J	59 (87)		
90	125	VFPS1-2900P	350	782 (1022)	370	298	758	360	72	150	30	K	72 (103)		
400V	0.75	1	VFPS1-4007PL	130	230	152	114	220	-	-	-	-	A	3	
	1.5	2	VFPS1-4015PL												
	2.2	3	VFPS1-4022PL												
	3.7	5	VFPS1-4037PL	155	260	164	138	249	-	-	-	-	B	4	
	5.5	7.5	VFPS1-4055PL	175	295	164	158	283	-	-	-	-	C	5.5	
	7.5	10	VFPS1-4075PL												
	11	15	VFPS1-4110PL	210	295	191	190	283	-	-	-	-	D	8	
	15	20	VFPS1-4150PL	230	400	191	210	386	-	-	-	-	E	13	
	18.5	25	VFPS1-4185PL												
	22	30	VFPS1-4220PL	240	420	212	206	403	-	-	-	-	F	21	
	30	40	VFPS1-4300PL	240	550	242	206	529	-	-	-	-	G	29	
	37	50	VFPS1-4370PL												
	45	60	VFPS1-4450PL												
	55	75	VFPS1-4550PL												
	75	100	VFPS1-4750PL	320	630	290	280	605	-	-	-	-	I	48	
	90	125	VFPS1-4900PC												
	110	150	VFPS1-4110KPC												
	132	200	VFPS1-4132KPC	350	782 (1022)	370	298	758	360	72	150	30	K	74 (108)	
	160	250	VFPS1-4160KPC	330	950 (1190)	370	285	920	340	75	150	30	L	82 (118)	
	220	350	VFPS1-4220KPC	430	950 (1190)	370	350	920	440	75	150	30	M	104 (161)	
250	400	VFPS1-4250KPC	585	950 (1190)	370	540	920	598	75	150	30	N	134 (194)		
280	450	VFPS1-4280KPC											136 (204)		
315	500	VFPS1-4315KPC											215 (302)		
400	600	VFPS1-4400KPC	880	1150 (1390)	370	418	1120	890	75	150	30	O	260 (370)		
500	700	VFPS1-4500KPC											330 (462)		
630	1000	VFPS1-4630KPC	1108	1150 (1390)	370	533	1120	1120	75	150	30	P	330 (462)		

Note: Value in () includes attached DC reactor.

■ Outline drawing

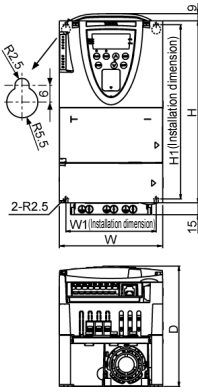

Fig. A

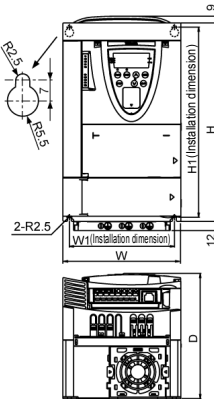
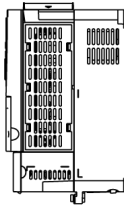

Fig. B

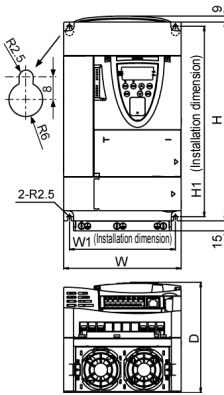
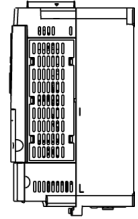

Fig. C

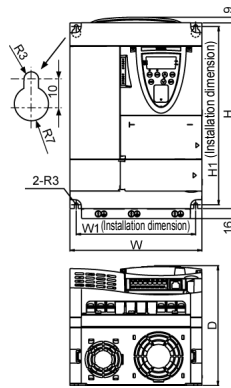
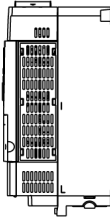

Fig. D

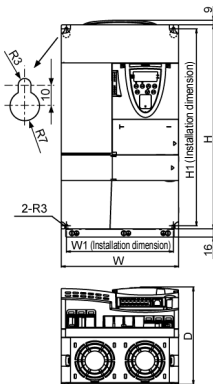
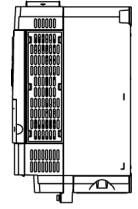

Fig. E

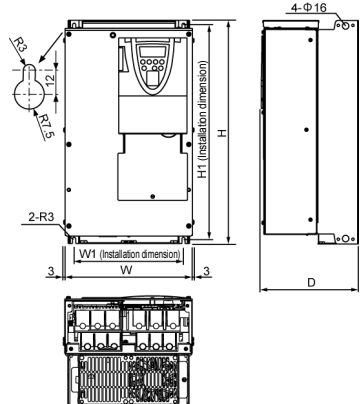
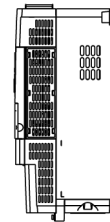

Fig. F

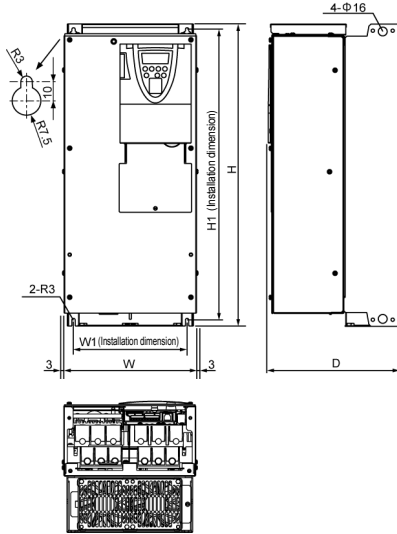

Fig. G

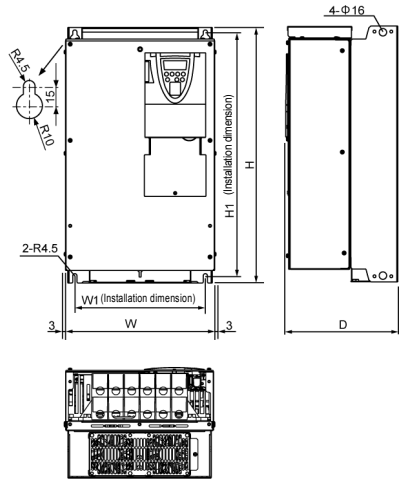

Fig. H

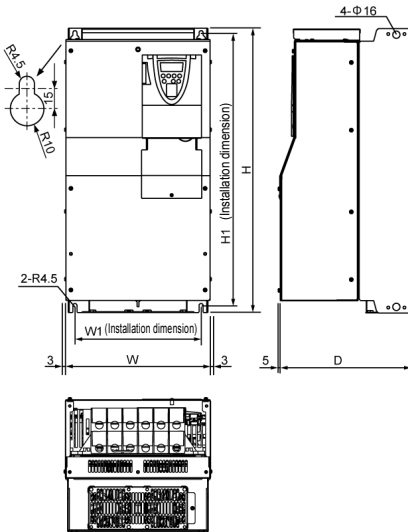

Fig. I

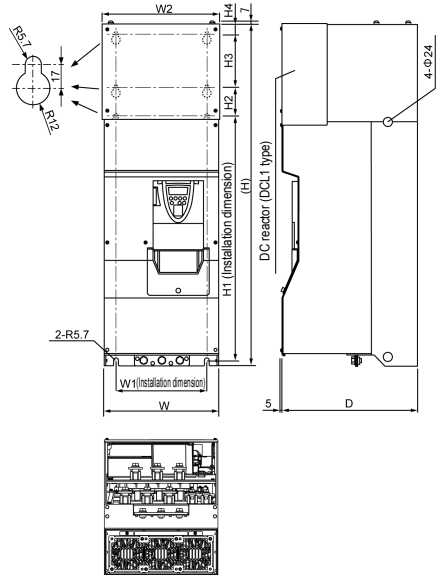

Fig. J

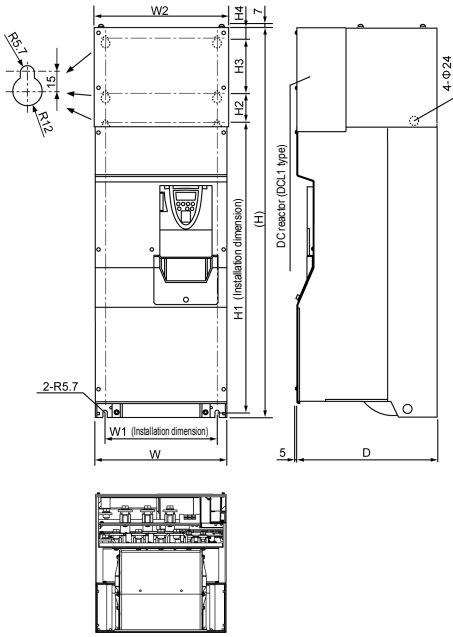

Fig. K

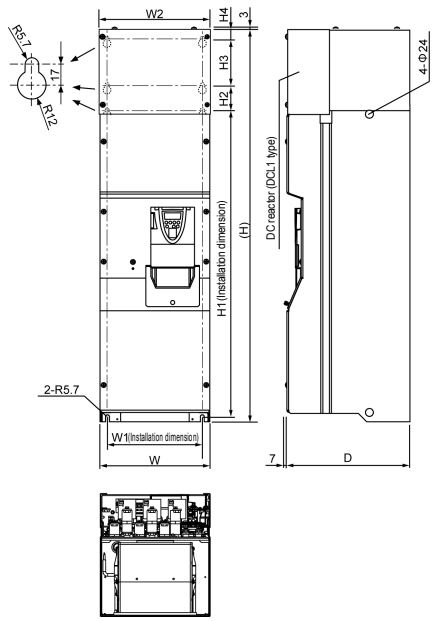

Fig. L

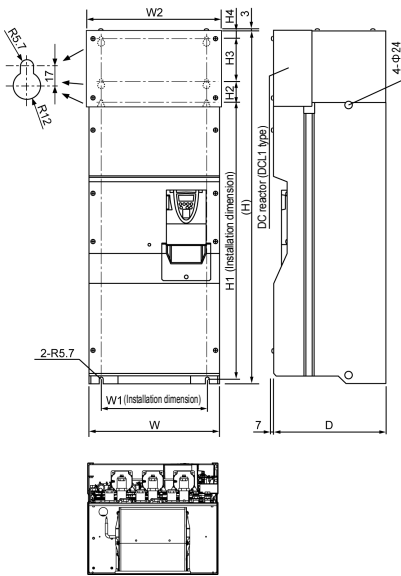

Fig. M

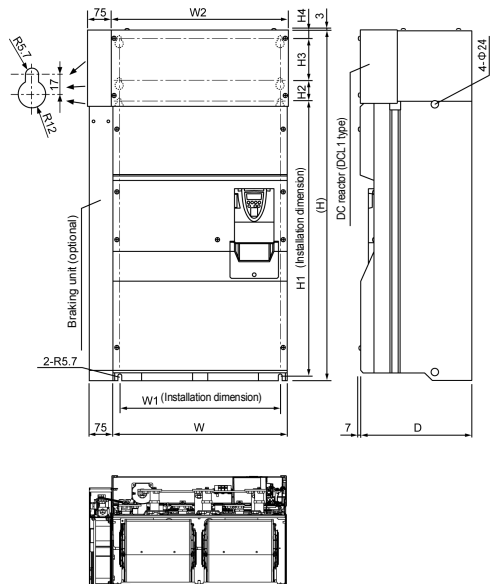

Fig. N

12

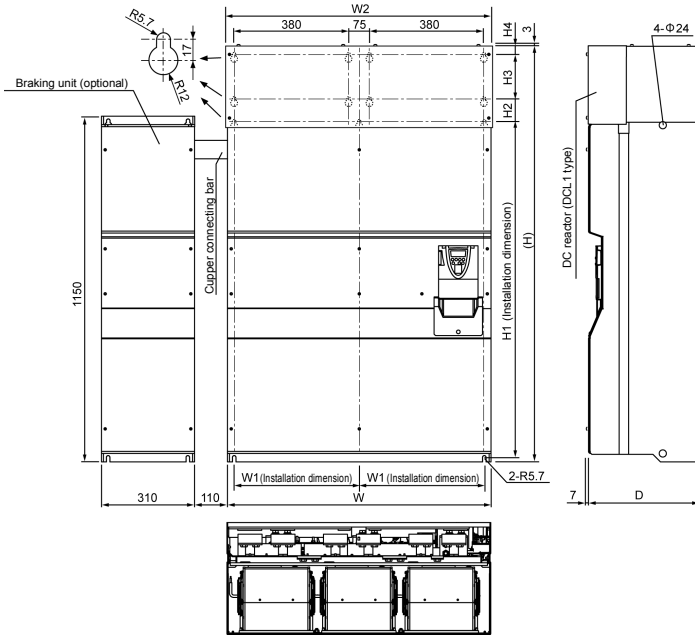

Fig. O

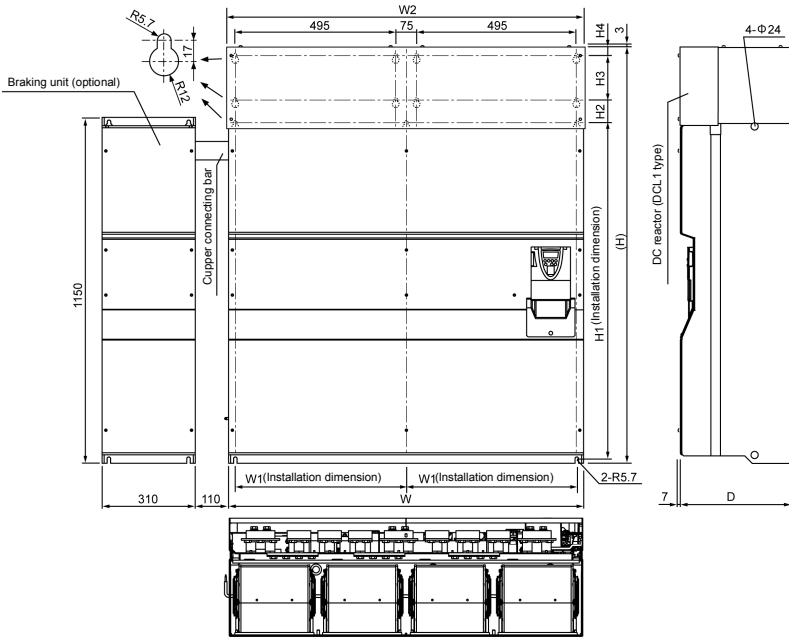

Fig. P

13. Before making a service call - Trip information and remedies

13.1 Trip causes/warnings and remedies

When a problem arises, diagnose it in accordance with the following table.

If it is found that replacement of parts is required or the problem cannot be solved by any remedy described in the table, contact your supplier.

[Trip information]

Error code	Description	Possible causes	Remedies
$\overline{OC1}$ $\overline{OC1P}$	Overcurrent during acceleration	<ul style="list-style-type: none"> The acceleration time \overline{ACC} is too short. The $\overline{V/f}$ setting is improper. A restart signal is input to the rotating motor after a momentary stop, etc. A special motor (e.g. motor with a small impedance) is used. Manual torque boost value (\overline{ub}) is large. 	<ul style="list-style-type: none"> Increase the acceleration time \overline{ACC}. Check the $\overline{V/f}$ parameter setting. Use $\overline{U5}$ (Auto-restart) and \overline{UOL} (Regenerative power ride-through control). Increase the carrier frequency \overline{CF}. Decrease \overline{ub} setting value. Decrease \overline{FSD} (stall prevention level) to 130 as a guide. Increase \overline{CF} (carrier frequency) setting value if it is set at lower value (2kHz or less).
$\overline{OC2}$ $\overline{OC2P}$	Overcurrent during deceleration	<ul style="list-style-type: none"> The deceleration time \overline{dEL} is too short. (in deceleration) 	<ul style="list-style-type: none"> Increase the deceleration time \overline{dEL}.
$\overline{OC3}$ $\overline{OC3P}$	Overcurrent during fixed speed	<ul style="list-style-type: none"> The load fluctuates abruptly. The load is in an abnormal condition. 	<ul style="list-style-type: none"> Reduce the load fluctuation. Check the load (operated machine).
[Note] $\overline{OC1P}$, $\overline{OC2P}$, $\overline{OC3P}$	originate from causes other than those mentioned above.	<ul style="list-style-type: none"> A main circuit elements is defective. Overheat protection is activated. 	<ul style="list-style-type: none"> Make a service call. Check operation of cooling fan. Check cooling fan control mode parameter \overline{FSDQ}.
$\overline{OCRA1}$	U-phase arm short-circuit	A main circuit elements is defective (U-phase).	Make a service call.
$\overline{OCRA2}$	V-phase arm short-circuit	A main circuit elements is defective (V-phase).	Make a service call.
$\overline{OCRA3}$	W-phase arm short-circuit	A main circuit elements is defective (W-phase).	Make a service call.
\overline{OCL}	Loaded side overcurrent at start time	<ul style="list-style-type: none"> The insulation of the output main circuit or motor is defective. The motor has too small impedance. The drive circuit board in the inverter was damaged. 	<ul style="list-style-type: none"> Check the cables and wires for defective insulation. Selection of short circuit detection at starting parameter $\overline{FSDI3}$. If this error message appears when a motor is not connected to the inverter, the inverter itself may be faulty, so make a service call.
\overline{OCLr}	Dynamic braking element overcurrent (200V-55kW or larger, 400V-90kW or larger)	<ul style="list-style-type: none"> PB-PC/+ circuit is shorted. A resistor with resistance smaller than the minimum allowable resistance is connected. Parameter \overline{PB} was set to 1 or 2 without connecting regenerative brake or with wire disconnected (with dynamic braking). 	<ul style="list-style-type: none"> Check the impedance wiring for the resistor, etc. Make a service call. Check if regenerative brake is connected. If regenerative brake is not necessary, set parameter \overline{PB} to 0.
\overline{OH}	Overheating	<ul style="list-style-type: none"> The cooling fan does not rotate. The ambient temperature is too high. The vent is blocked up. A heat generating device is installed close to the inverter. The thermistor in the unit is disconnected. 	<ul style="list-style-type: none"> Restart the operation by resetting the inverter after it has cooled down enough. The fan requires replacement if it does not rotate during operation. Secure sufficient space around the inverter. Do not place any heat generating device near the inverter. Make a service call.
\overline{OHz}	Thermal trip stop command from external device	<ul style="list-style-type: none"> An input signal is impressed at control input terminal PTG for optional add-on cards. A thermal trip command (input terminal function: 45 or 47) is issued by an external control device. 	<ul style="list-style-type: none"> The motor is overheated, so check whether the current flowing into the motor exceeds the rated current.

* In the event one of the error codes $\overline{OC1P}$ to $\overline{OC3P}$ and $\overline{OCRA1}$ to $\overline{OCRA3}$ appears, in which case a main circuit component has most probably failed, the only way to reset the inverter is to turn power off and back on.

(Continued overleaf)

(Continued)

Error code	Description	Possible causes	Remedies
$OL1$	Inverter overload	<ul style="list-style-type: none"> •Rapid acceleration is operated. •The DC braking amount is too large. •The V/f setting is improper. •A restart signal is input to the rotating motor after a momentary stop, etc. •The load is too large. 	<ul style="list-style-type: none"> •Increase the acceleration time PLC. •Reduce the DC braking amount $F251$ and the DC braking time $F252$. •Check the V/f parameter setting. •Use $U05$ (Auto-restart) and $U0C$ (Regenerative power ride-through control). •Use an inverter with a larger rating.
$OL2$	Motor overload	<ul style="list-style-type: none"> •The V/f parameter is improperly set. •The motor is locked up. •Low-speed operation is performed continuously. •An excessive load is applied to the motor during operation. 	<ul style="list-style-type: none"> •Check the V/f parameter setting. •Check the load (operated machine). •Check the OLN setting and adjust $F606$ according to the sustainable overload in the motor low-speed range. • Reduce the DC braking amount $F251$ and the DC braking time $F252$.
OLr	Dynamic braking resistor overload	<ul style="list-style-type: none"> •Rapid deceleration is operated. •Dynamic braking is too large. 	<ul style="list-style-type: none"> •Increase the deceleration time dEL. •Increase the capacity of dynamic braking resistor (wattage) and adjust PBR capacity parameter $PbrP$.
$OP1$	Overtorque during acceleration	<ul style="list-style-type: none"> •The input voltage fluctuates abnormally. (1)The power supply has a capacity of 500kVA or more. (2)A power factor improvement capacitor is opened and closed. (3)A system using a thyrister is connected to the same power distribution line. •A restart signal is input to the rotating motor after a momentary stop, etc. 	<ul style="list-style-type: none"> •Insert a suitable input reactor. •Use $U05$ (Auto-restart) and $U0C$ (Regenerative power ride-through control).
$OP2$	Overtorque during deceleration	<ul style="list-style-type: none"> •The deceleration time dEL is too short (regenerative energy is too large). •The dynamic braking resistor has a considerably large resistance. •Pbr (Dynamic braking resistor) is OFF. •Overtorque limit operation $F305$ is OFF. (1)The input voltage fluctuates abnormally. (1)The power supply has a capacity of 500kVA or more. (2)A power factor improvement capacitor is opened and closed. (3)A system using a thyrister is connected to the same power distribution line. 	<ul style="list-style-type: none"> •Increase the deceleration time dEL. •Install a dynamic braking resistor. •Decrease dynamic braking resistance. (Also reset the Pbr.) •Set dynamic braking mode parameter Pbr properly. •Set overtorque limit operation $F305$ properly. •Insert a suitable input reactor.
$OP3$	Overtorque during fixed speed operation	<ul style="list-style-type: none"> •The input voltage fluctuates abnormally. (1)The power supply has a capacity of 500kVA or more. (2)A power factor improvement capacitor is opened and closed. (3)A system using a thyrister is connected to the same power distribution line. •The motor is in a regenerative state because the load causes the motor to run at a frequency higher than the inverter output frequency. 	<ul style="list-style-type: none"> •Insert a suitable input reactor. •Install a dynamic braking resistor.
$*Ot$	Overtorque	<ul style="list-style-type: none"> •Overtorque reaches to a detection level during operation. 	<ul style="list-style-type: none"> •Check system error. •Check whether the motor is overloaded or the brake is engaged.
$*UL$	Low current operation	<ul style="list-style-type: none"> •The output current decreased to a low-current detection level during operation. 	<ul style="list-style-type: none"> •Check the suitable detection level for the system ($F511$). •Make a service call if the setting is correct.
$*UP1$	Undervoltage (main circuit)	<ul style="list-style-type: none"> •The input voltage (in the main circuit) is too low. 	<ul style="list-style-type: none"> •Check the input voltage.
E	Emergency stop	<ul style="list-style-type: none"> •Inverter is stopped by panel operation during automatic or remote operation. •A stop command (input terminal function: 20 or 21) is issued by an external control device. 	<ul style="list-style-type: none"> •Reset the inverter.

*Presence or absence of parameter trip can be selected.

(Continued overleaf)

(Continued)

Error code	Description	Possible causes	Remedies
$E P 1$	EEPROM error	•A data writing error occurs.	•Turn off the inverter, then turn it again. If it does not recover from the error, make a service call.
$E P 2$	Initial read error	•Some internal data is corrupted. •Power was turned off while $E Y P$ was being set.	•Make a service call. •Set $E Y P$ again. If the inverter does not recover from the error, make a service call.
$E P 3$	Initial read error	•Some internal data is corrupted.	•Make a service call.
$E F 1$ $E F 2$	Ground fault	•A current leaked from an output cable or the motor to ground.	•Check the cable and the motor for ground faults.
* $E P H 0$	Output phase failure	•A phase failure occurred in the output line of the main circuit.	•Check the main circuit output line, motor, etc. for phase failure. •Select output phase failure detection parameter $F 5 0 5$.
* $E P H 1$	Input phase failure	•A phase failure occurred in the input line of the main circuit.	•Check the main circuit input line for phase failure.
$E r r 2$	Main unit RAM fault	•The control RAM is defective.	•Make a service call.
$E r r 3$	Main unit ROM fault	•The control ROM is defective.	•Make a service call.
$E r r 4$	CPU fault	•The control CPU is defective.	•Make a service call.
$E r r 5$	Communication time-out error	•A normal communication was not possible for the time or longer set by $F 0 0 3$.	•Check the remote control device, cables, etc.
$E r r 6$	Gate array fault	•Main gate array is defective.	•Make a service call.
$E r r 7$	Output current detector error	•The main output current detector is defective.	•Make a service call.
$E r r 8$	Optional unit fault	•An optional device has failed. (such as a communication device [add-on option])	•Check the connection of optional board(s). •Refer to instructions of options concerned specified in Section 6.36.
$E t n$	Tuning error	•The capacity of the motor connected is 2 notches or more smaller than the inverter capacity. •The motor connected is not a three-phase inductive motor. •Tuning is performed while the motor is running.	•Make sure that a motor is connected. •Make sure that the motor is at standstill. •Perform auto-tuning 1 again and if the error persists, perform tuning manually.
$E t n 1$	$F 4 1 0$ tuning error	•Tuning required to boost torque as specified with $F 4 1 0$ cannot be performed. •The capacity of the motor connected is 2 notches or more smaller than the inverter capacity. •The motor connected is not a three-phase inductive motor. •Tuning is performed while no motor is connected. •The cables connecting the inverter to the motor are too long; they are more than 30m in length. •Tuning is performed while the motor is running.	•Make sure that a motor is connected. •Make sure that the motor is at standstill. •Perform auto-tuning 1 again and if the error persists, perform tuning manually.
$E t n 2$	$F 4 1 2$ tuning error	•Tuning required to leak inductance as specified with $F 4 1 2$ cannot be performed. •Tuning required to boost torque as specified with $F 4 1 0$ cannot be performed. •The capacity of the motor connected is 2 notches or more smaller than the inverter capacity. •The motor connected is not a three-phase inductive motor. •Tuning is performed while no motor is connected. •The cables connecting the inverter to the motor are too long; they are more than 30m in length. •Tuning is performed while the motor is running.	•Make sure that a motor is connected. •Make sure that the motor is at standstill. •Perform auto-tuning 1 again and if the error persists, perform tuning manually.
$E t n 3$	Motor constant setting error	Some items indicated on the motor nameplate are not entered correctly. •Base frequency $U L$ •Base frequency voltage $1 U L U$ •Motor rated capacity $F 4 0 5$ •Motor rated current $F 4 0 6$ •Motor rated speed $F 4 0 7$	•Make sure that all items on the motor nameplate are entered correctly.

*Presence or absence of parameter trip can be selected.

(Continued overleaf)

(Continued)

Error code	Description	Possible causes	Remedies
E 4 P	Inverter type error	•Is circuit board (or main circuit/drive circuit board) replaced?	•When board has been replaced, input 6 for E 4 P.
E - 10	Analog input terminal overvoltage	•Overrated voltage is applied to analog input.	•Apply voltage within the rated voltage.
E - 11	Sequence error	•The signal from system is not inputted into input terminals. •The input terminal function (I 3 0, I 3 1) is not set up.	•Please check if the sequence is normal or not. •Please set I 3 0 or I 3 1 as the input terminal to use.
E - 12	Encoder error	•Disconnection of encoder circuit. •The encoder is not connected correctly.	•Check connection of encoder. Connect encoder correctly. •Check whether the setting of F 3 7 6 matches the phase-A and phase-B connections of the encoder.
E - 13	Speed error (Over speed)	•Encoder error (inverter error)	•Check connection of encoder. Connect encoder correctly.
E - 17	Key failure alarm	•The same key is input continuously more than 20 seconds.	•Check the operation panel.
E - 18	Terminal input error	•Braking down of a wire for VI/II input signal. •Terminal circuit board comes off and falls •P24 overcurrent	•Check VI/II input signal. •Install the control terminal board to the inverter. •Check P24 terminal short circuit to CC or CCA.
E - 19	Abnormal CPU2 communication	•An error arises during CPU2 communication.	•Make a service call.
E - 20	V/f control error	•An internal control error occurs.	•Make a service call.
E - 21	CPU1 fault	•A software error occurs in the control CPU.	•Make a service call.
E - 22	Abnormal logic input voltage	•An abnormal voltage is applied to the control logic input terminal.	•Check the signal given to the logic connected with the input terminal.
E - 23	Option 1 error	•Expansion I/O card 1 is defective.	•Make a service call.
E - 24	Option 2 error	•Expansion I/O card 2 is defective.	•Make a service call.
E - 25	Stop position retaining error	•A deviation error occurs during stop position retaining control. •Creeping speed is too fast.	•Check connection of encoder. •Adjust the proportional P gain F 3 6 2. •Lower the creeping speed.
E - 26	CPU2 fault	•Motor control CPU is defective. •The drive circuit board in the inverter was damaged.	•Make a service call.
E - 29	Control power backup undervoltage error	•The control voltage between +SU and CC terminals is too low. •Control power is not supplied through +SU and CC terminals. •The parameter F 5 4 7 is not set correctly.	•Check whether the voltage between +SU and CC terminals is DC20V or more. •Set F 5 4 7 to 0 if a control power backup device is not connected to +SU and CC terminals. To reset the inverter that has been tripped because of this error, turn it off and then back on.
S 0 U E	Step-out (for PM motors only)	•The motor shaft is locked. •One output phase is open. •An impact load is applied.	•Unlock the motor shaft. •Check the interconnect cables between the inverter and the motor.
P r F	Power removal error	•Error of power removal circuit	•Make a service call.

Note: Please contact us if you find any trips other than the above.

[Alarm] The following are messages only. No trip is developed.

Error code	Problem	Possible causes	Remedies
0 F F	ST signal OFF	•ST terminal (terminal to which the ST function is assigned) is in open-circuit.	•Close ST (terminal to which the ST function is assigned)-CC circuit.
P r R	PWR signal OFF	•PWR terminal is in open-circuit.	•Close PWR-P24 circuit.
0 0 F F	Control power backup undervoltage	•The control voltage between +SU and CC terminals is too low. •Control power is not supplied through +SU and CC terminals. •The parameter F 5 4 7 is not set correctly.	•Check whether the voltage between +SU and CC terminals is DC20V or more. •Set F 5 4 7 to 0 if a control power backup device is not connected to +SU and CC terminals. In the event of a 0 0 F F error, the inverter will not be reset automatically even if the control voltage between +SU and CC terminals returns to its normal level. To reset the inverter, turn it off and then back it on.

(Continued overleaf)

(Continued)

Error code	Problem	Possible causes	Remedies
<i>n g f f</i>	Undervoltage in main circuit	<ul style="list-style-type: none"> The supply voltage between R, S and T is under voltage. Trouble of rush current restraint circuit or DC circuit fuse. 	<ul style="list-style-type: none"> Measure the main circuit supply voltage. If the voltage is at a normal level, the inverter requires repairing. Make a service call.
<i>r t r y</i>	Retry	<ul style="list-style-type: none"> The inverter is in the process of retry. A momentary stop occurred. 	<ul style="list-style-type: none"> The inverter is normal if it restarts after several tens of seconds. The inverter restarts automatically. Be careful of the machine because it may suddenly restart.
<i>E r r 1</i>	Point setting alarm	<ul style="list-style-type: none"> The frequency setting signals at points 1 and 2 are set too close to each other. 	<ul style="list-style-type: none"> Set the frequency setting signals at points 1 and 2 apart from each other.
<i>E L r</i>	Clear enabling indication	<ul style="list-style-type: none"> This message is displayed when pressing the STOP key while an error code is displayed. Input terminal RES signal is ON during trip display. 	<ul style="list-style-type: none"> Press the STOP key again to clear the trip. Turn off the input terminal RES signal.
<i>E g f f</i>	Emergency stop enabling indication	<ul style="list-style-type: none"> The operation panel is used to stop the operation in automatic control or remote control mode. 	<ul style="list-style-type: none"> Press the STOP key for an emergency stop. To cancel the emergency stop, press any other key.
<i>H i l d</i>	Setting error alarm An error code and data are displayed alternately twice each.	<ul style="list-style-type: none"> An error is found in a setting when data is reading or writing. 	<ul style="list-style-type: none"> Check whether the setting is made correctly.
<i>d b</i>	DC braking	<ul style="list-style-type: none"> DC braking in process 	<ul style="list-style-type: none"> The message goes off in several tens of seconds if no problem occurs. [Note]
<i>d b o n</i>	Shaft fixing in control	<ul style="list-style-type: none"> Motor shaft fixing control is in process. 	<ul style="list-style-type: none"> If the message disappears by stop command (ST (terminal to which the ST function is assigned)-CC open), it is normal.
<i>F i r E</i>	In forced operation	<ul style="list-style-type: none"> It is displayed at setting the parameter <i>F 5 5 0</i> to "1". "<i>F i r E</i>" and operation frequency is displayed alternately in operation of forced fire-speed control. 	<ul style="list-style-type: none"> Continue to press the ENTER key for 2 seconds at setting the parameter <i>F 5 5 0</i> to "1". It is normal the alarm is gone out after the forced fire-speed control operation.
<i>E r - p</i>	Setting error alarm	<ul style="list-style-type: none"> It is displayed at setting the parameter <i>P 4</i> to "4" or "8". No operation at setting "4" or "8". 	<ul style="list-style-type: none"> Please select the parameter <i>P 4</i> to other numbers except "4" and "8".
<i>E 1 E 2 E 3</i>	Panel indication overflow	<ul style="list-style-type: none"> The digit number of the item displayed, e.g., frequency, is in excess of the specified digit number. (Number of overflowing digits is indicated.) 	<ul style="list-style-type: none"> For indication of frequency, set multiplying rate (<i>F 7 0 2</i>) lower. (Parameter setting that results in overflow is of course valid.)
<i>i n i t</i>	Parameters in the process of initialization	<ul style="list-style-type: none"> Parameters are being initialized to default values. 	<ul style="list-style-type: none"> Normal if the message disappears after a while (several seconds to several tens of seconds).
<i>R t n</i>	In auto-tuning 1	<ul style="list-style-type: none"> Auto-tuning 1 in process. 	<ul style="list-style-type: none"> Normal if it the message disappears after a few seconds.
<i>L S t P</i>	Auto-stop because of continuous operation at the lower-limit frequency	<ul style="list-style-type: none"> The automatic stop function of <i>F 2 5 5</i> is being performed. 	<ul style="list-style-type: none"> This function is deactivated when the command frequency becomes 0.2Hz or more higher than the lower-limit frequency (LL) or when a command for stopping operation is entered.
<i>S t o P</i>	Momentary power failure slowdown stop prohibition function activated.	<ul style="list-style-type: none"> The deceleration stop function of <i>U u C</i> (regenerative power ride-through control) is activated. 	<ul style="list-style-type: none"> To restart operation, reset the inverter or input an operation signal again.
<i>H E R d / E n d</i>	Display of first/last data items	<ul style="list-style-type: none"> First and last data in the <i>R U H</i> group. 	<ul style="list-style-type: none"> To exit from the group, press the MODE key.
<i>U n d o</i>	Key operation permitted temporarily	<ul style="list-style-type: none"> This message appears if the ENTER key is pressed and held down for 5 seconds or more when key operation is prohibited by <i>F 7 3 7</i>. 	<ul style="list-style-type: none"> When this message is displayed, all the keys are operational. To prohibit key operation again, turn off the inverter and then turn it back on.

Note: In the case of DC injection braking ON/OFF function is selected for an input terminal; if "d b" disappears as a result of open-circuit between the terminal and CC, it is normal.

[Pre-alarm display]

Error code	Description	Possible causes	Remedies
\bar{C}	Overcurrent pre-alarm	Same as $\bar{O}\bar{C}$ (Overcurrent)	Same as $\bar{O}\bar{C}$ (Overcurrent)
\bar{P}	Overvoltage pre-alarm Achieving PBR operation level	Same as $\bar{O}\bar{V}$ (Overvoltage) \bar{P} blink while PBR is operating is not an error.	Same as $\bar{O}\bar{V}$ (Overvoltage) \bar{P} blink while PBR is operating is not an error.
\bar{L}	Overload pre-alarm	Same as $\bar{O}\bar{L} 1$ and $\bar{O}\bar{L} 2$ (Overload)	Same as $\bar{O}\bar{L} 1$ and $\bar{O}\bar{L} 2$ (Overload)
\bar{H}	Overheat pre-alarm	Same as $\bar{O}\bar{H}$ (Overheat)	Same as $\bar{O}\bar{H}$ (Overheat)
\bar{E}	Communication error	<ul style="list-style-type: none"> •Various transmission errors occur when computer is linked up with inverter system. •Various transmission errors occur in inverter to inverter communication (slave side). Time-out or trip in master side. 	<ul style="list-style-type: none"> •For measures to correct various kinds of data transmission errors, refer to the instruction manual for the communications device used specified in Section 6.36. •Check the master inverter.

If two or more problems arise simultaneously, one of the following alarms appears and blinks.

$\bar{C}\bar{P}$, $\bar{P}\bar{L}$, $\bar{L}\bar{H}$, $\bar{C}\bar{P}\bar{L}$,, $\bar{C}\bar{P}\bar{L}\bar{H}$

The blinking alarms \bar{C} , \bar{P} , \bar{L} , \bar{H} , \bar{E} are displayed in this order from left to right.

13.2 Method of resetting causes of trip

Do not reset the inverter when tripped because of a failure or error before eliminating the cause. Resetting the tripped inverter before eliminating the problem causes it to trip again.

For recovering inverter from trip status,

- (1) By turning off the power (Keep the inverter off until the LED turns off.)
 ⇒ Refer to Section 6.26.2 (inverter trip retention selection $F 5 \bar{O}\bar{E}$) for details.
- (2) By means of an external signal (shorting RES and CC on control terminal board → release)
- (3) By operation panel operation
- (4) By means of a communication
 ⇒ For details, refer to the instruction manual for the communications device used specified in section 6.36.

reset it in one of the following ways.

To reset the inverter by operation panel operation, follow these steps.

1. Check whether the LED on the control panel indicates that tripping has occurred. If the occurrence of tripping is not indicated, press the MODE key to display it.
2. Press the STOP key and make sure that $\bar{C}\bar{L} r$ is displayed.
3. Pressing the STOP key again will reset the inverter if the cause of the trip has already been eliminated.

★ If the inverter is tripped because of an overload on the braking resistor ($\bar{O}\bar{L} r$), it cannot be reset for approx. 20 seconds (virtual cooling period).

If the inverter is tripped because of an overload on the inverter ($\bar{O}\bar{L} 1$) or an overload on the motor ($\bar{O}\bar{L} 2$), it can be reset even during the virtual cooling period (approx. 30 seconds for $\bar{O}\bar{L} 1$, or approx. 20 seconds for $\bar{O}\bar{L} 2$). Note that the inverter is apt to be tripped during the cooling period.

★ If the inverter trips because of overheating ($\bar{O}\bar{H}$), reset it after a considerably long time enough for cooling it down completely, because overheating is detected based on its internal temperature.

- Caution -

For quickly recovering inverter from trip status, turn it off once and reset it. However, this measure is taken frequently, it may cause damage to the motor and other component units.

13.3 If the motor does not run while no trip message is displayed...

If the motor does not run while no trip message is displayed, follow these steps to track down the cause.

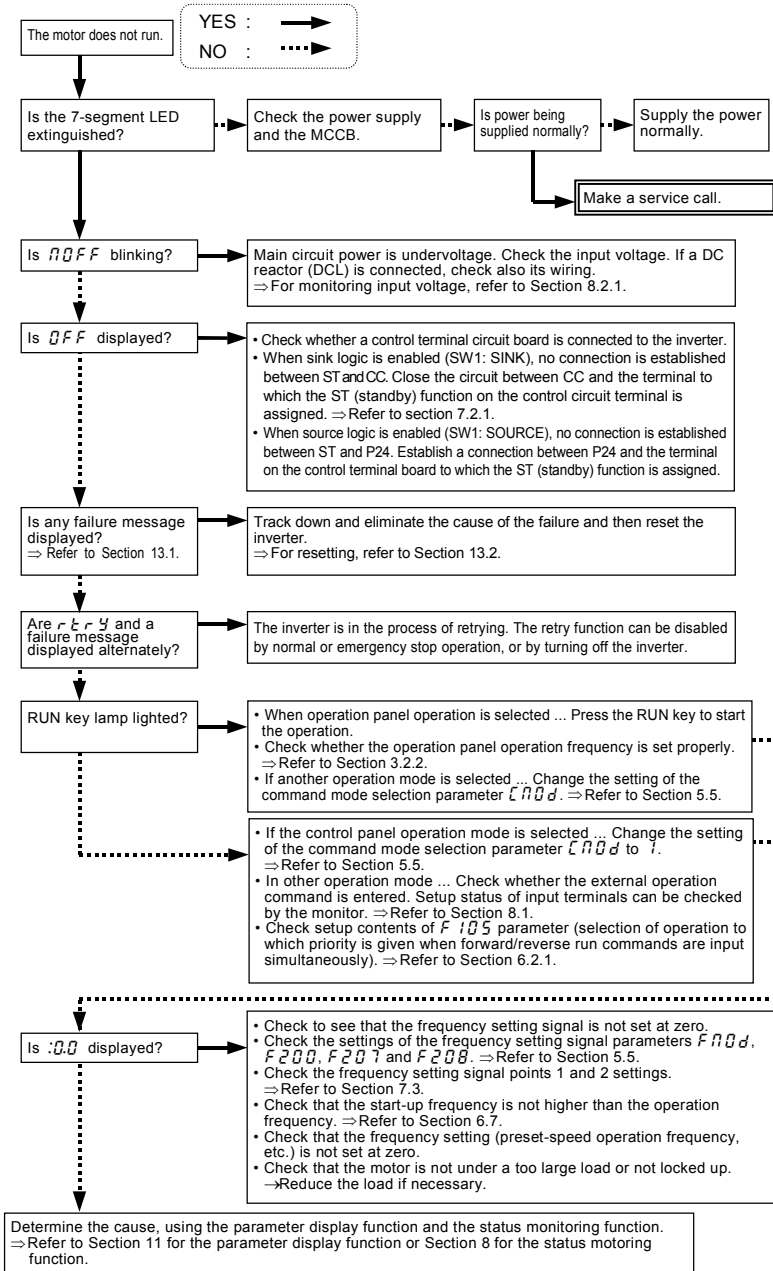

13.4 How to check other troubles



The following table provides a listing of other troubles, their possible causes and remedies.

Troubles	Causes and remedies
The motor runs in the wrong direction.	<ul style="list-style-type: none"> •Invert the phases of the output terminals U, V and W. •Invert the forward/reverse run signal terminals of the external input device. ⇒ Refer to Section 7.2, Assignment of functions to control terminals.
The motor runs but its speed does not change normally.	<ul style="list-style-type: none"> •The load is too heavy. •Reduce the load. •Soft stall function is activated. Switch off soft stall function. ⇒ Refer to Section 5.14. •The maximum frequency FH and the upper limit frequency UL are set too low. Increase the maximum frequency FH and the upper limit frequency UL. •The frequency setting signal is too low. Check the signal set value, circuit, cables, etc. •Check the setting characteristics (point 1 and point 2 settings) of the frequency setting signal parameters. ⇒ Refer to Section 7.3. •The base frequency voltage ULU is too low. •If the motor runs at a low speed, check to see that the stall prevention function is activated because the torque boost amount is too large. Adjust the torque boost amount (ub) and the acceleration time (RLC). ⇒ Refer to Section 5.7 and 5.2.
The motor does not accelerate or decelerate smoothly.	<ul style="list-style-type: none"> •The acceleration time (RLC) or the deceleration time (dEL) is set too short. Increase the acceleration time (RLC) or the deceleration time (dEL).
A too large current flows into the motor.	<ul style="list-style-type: none"> •The load is too heavy. Reduce the load. •If the motor runs at a low speed, check whether the torque boost amount is too large. ⇒ Refer to Section 5.7.
The motor runs at a higher or lower speed than the specified one.	<ul style="list-style-type: none"> •The motor has improper voltage rating. Use a motor with a proper voltage rating. •The motor terminal voltage is too low. Check the setting of the base frequency voltage parameter (ULU). ⇒ Refer to Section 5.8. Change the cable for thicker one. •The reduction gear ratio, etc., is not set properly. Adjust the reduction gear ratio, etc. •The output frequency is not set correctly. Check the output frequency range. •Adjust the base frequency. ⇒ Refer to Section 5.8.
The motor speed varies during operation.	<ul style="list-style-type: none"> •The load is too heavy or too light. Reduce the load fluctuation. •The inverter or motor used does not have a rating large enough to drive the load. Use an inverter or motor with a rating large enough. •Check whether the frequency setting signal changes. •If the V/f control selection parameter Pf is set at 2 or larger (5 and 6 are removed.), check the vector control setting, operation conditions, etc. ⇒ Refer to Section 5.6.
Some or all of seven keys on operation panel don't work.	<ul style="list-style-type: none"> •Change panel operation prohibition parameter $F730 \sim F737$.
Access to parameter results in failure.	<ul style="list-style-type: none"> * Parameter is occasionally set for key operation prohibition mode. Cancel key operation prohibition mode according to the following procedure. To cancel the setting, press and hold down the ENTER key for 5 seconds or more.
Parameter settings cannot be changed.	<ul style="list-style-type: none"> (1) If parameter write protect selection parameter $F700$ is set at 1 (prohibited), change the setting to 0 (allowed).
Monitor (Display) is uncontrollable.	<ul style="list-style-type: none"> (2) If there is an input terminal that is set for $!!!$ (or $!!!$) (parameter editing enabling) by input terminal function parameter, turn on the terminal.

How to cope with parameter setting-related problems

If you forget parameters which have been reset	<ul style="list-style-type: none"> •You can search for all reset parameters and change their settings. ⇒ Refer to Section 5.21 for details.
If you want to return all reset parameters to their respective default settings	<ul style="list-style-type: none"> •You can return all parameters which have been reset to their default settings. ⇒ Refer to Section 5.20 for details.

14. Inspection and maintenance

 Danger	
 Mandatory	<ul style="list-style-type: none"> • The equipment must be inspected every day. If the equipment is not inspected and maintained, errors and malfunctions may not be discovered which could lead to accidents. • Before inspection, perform the following steps. <ol style="list-style-type: none"> (1) Shut off all input power to the inverter. (2) Wait at least 15 minutes and check to make sure that the charge lamp is no longer lit. (3) Use a tester that can measure DC voltages (800V DC or more), and check that the voltage to the DC main circuits (between PA/+ and PC/-) does not exceed 45V. <p style="margin-left: 20px;">Performing an inspection without carrying out these steps first could lead to electric shock.</p>

Be sure to inspect the inverter regularly and periodically to prevent it from breaking down because of the environment of use, such as temperature, humidity, dust and vibration, or deterioration of its components with aging.

14.1 Regular inspection

Electronic parts are easily affected by heat. Install the Inverter in a cool, well-ventilated, dust-free area for achieving the original performance for a prolonged amount of time in demonstrate its original performance for a long time. The purpose of regular inspections is to maintain the correct environment of use and to find any sign of failure or malfunction by comparing current operation data with past operation records.

Subject of inspection	Inspection procedure			Criteria for judgment
	Inspection item	Inspection cycle	Inspection method	
1. Indoor environment unit	1) Dust and gas 2) Drooping of water and other liquid 3) Ambient temperature	Occasionally Occasionally Occasionally	1) Visual check, check by means of a thermometer, smell check 2) Visual check 3) Check by means of a thermometer	1) Improve bad points. 2) Check for any trace of water condensation. 3) Max. temperature: 60°C
2. Component parts and units	1) Vibration and noise	Occasionally	Tactile check of the cabinet	Is something unusual is found, open the door and check the transformer, reactors, contactors, relays, cooling fan, etc., inside. If necessary, stop the operation.
3. Operation data (output side)	1) Load current 2) Voltage (*)	Occasionally Occasionally	Moving-iron type AC ammeter Rectifier type AC voltmeter	To be within the rated voltage and current according to unit ambient temperature. No significant difference from data collected in a normal state.

*: The voltage measured may slightly vary from voltmeter to voltmeter. When measuring the voltage, always take readings from the same circuit tester or voltmeter.

■ Check points

1. Something unusual in the installation environment
2. Something unusual in the cooling system
3. Unusual vibration or noise
4. Overheating or discoloration
5. Unusual odor
6. Unusual motor vibration, noise or overheating
7. Adhesion or accumulation of foreign substances (conductive substances)



■ Cautions about cleaning

To clean the inverter, wipe dirt off only its surface with a soft cloth but do not try to remove dirt or stains from any other part. If stubborn stains persist, remove them by wiping gently with a cloth dampened with neutral detergent or ethanol. Never use any of the chemicals in the table below; the use of any of them may damage or peel the coating away from molded parts (such as plastic covers and units) of the inverter.

Acetone	Ethylene chloride	Tetrachloroethane
Benzen	Ethyl acetate	Trichloroethylene
Chloroform	Glycerin	Xylene

14.2 Periodical inspection

Make a periodical inspection at intervals of 3 or 6 months depending on the operating conditions.

 Danger	
 Mandatory	<ul style="list-style-type: none"> • Before inspection, perform the following steps. <ul style="list-style-type: none"> (1) Shut off all input power to the inverter. (2) Wait at least 15 minutes and check to make sure that the charge lamp is no longer lit. (3) Use a tester that can measure DC voltages (800VDC or more), and check that the voltage to the DC main circuits (between PA/+ and PC/-) does not exceed 45V. • Performing an inspection without carrying out these steps first could lead to electric shock.
 Prohibited	<ul style="list-style-type: none"> • Never replace any part. • This could be a cause of electric shock, fire and bodily injury. To replace parts, call the local sales agency.

■ Check items

1. Check to see if all screwed terminals are tightened firmly. If any screw is found loose, tighten it again with a screwdriver.
2. Check to see if all caulked terminals are fixed properly. Check them visually to see that there is no trace of overheating around any of them.
3. Check all cables and wires for damage. Check them visually.
4. Clean up dust and soil. With a vacuum cleaner, remove dirt and dust. When cleaning, clean the vents and the printed circuit boards. Always keep them clean to prevent a damage due to dirt or dust.
5. If no power is supplied to the inverter for a long time, the performance of its large-capacity electrolytic capacitor declines. When leaving the inverter unused for a long time, supply it with electricity once every two years, for 5 hours or more each, to check the operation of the inverter. Supply electricity for at least 5 hours with the motor disconnected. It is advisable not to supply the commercial power directly to the inverter but to gradually increase the power supply voltage with a transformer.
6. If insulation test is needed, conduct it for the main circuit terminal board using a 500V insulation resistance tester only. Never conduct an insulation test on control terminals other than terminals on the printed circuit board or on control terminals. When testing the motor for insulation performance, separate it from the inverter in advance by disconnecting the cables from the inverter output terminals U, V and W. When conducting an insulation test on peripheral circuits other than the motor circuit, disconnect all cables from the inverter so that no voltage is applied to the inverter during the test.

Note: Before an insulation test, always disconnect all cables from the main circuit terminal board and test the inverter separately from other equipment.

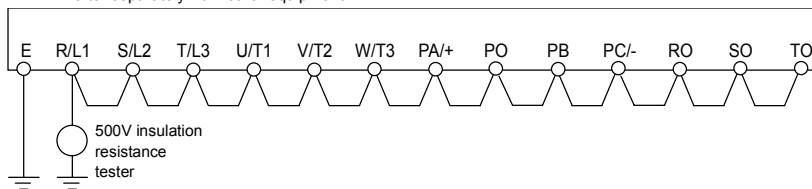

7. Never test the inverter for pressure. A pressure test may cause damage to its components.
8. Voltage and temperature check

Recommended voltmeter

Input side ... Moving-iron type voltmeter ()

Output side ... Rectifier type voltmeter ()

It will be very helpful for detecting a defect if you always measure and record the ambient temperature before, during and after the operation.

Replacement of expendable parts

The inverter is composed of a large number of electronic parts including semiconductor devices. The following parts deteriorate with the passage of time because of their composition or physical properties. The use of aged or deteriorated parts leads to degradation in the performance or a breakdown of the inverter. To avoid such trouble, the inverter should be checked periodically.

Note: Generally, the life of a part depends on the ambient temperature and the conditions of use. The life spans listed below are applicable to parts when used under normal environmental conditions.

1) Cooling fan

The fan, which cools down heat-generating parts, has a service life of about 30,000 hours (about 7 years) (average ambient temperature: 40°C, operation time: 12 hours per day). The fan also needs to be replaced if it makes a noise or vibrates abnormally.

Remove the portion A and then portion B in the following figure to remove the cooling fan.

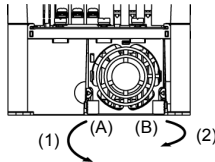

2) Smoothing capacitor

The smoothing aluminum electrolytic capacitor in the main circuit DC section degrades in performance because of ripple currents, etc. The smoothing aluminum electrolytic capacitor in the main circuit DC section degrades in performance because of ripple currents, etc. It becomes necessary to replace the capacitor after it is used for about 5 years under normal conditions (average ambient temperature: 40°C, load factor: not more than 80%, operation time: 12 hours per day). For the inverter that applicable motor output is 15kW (200V)-18.5kW (400V) or less, replace the capacitor together with the printed circuit board.

<Criteria for appearance check>

- Absence of liquid leak
- Safety valve in the depressed position
- Measurement of electrostatic capacitance and insulation resistance

Note: When it becomes necessary to replace expendable parts, contact your supplier. For safety's sake, never replace any part on your own.

By checking the cumulative operating time and the part replacement alarm information, you can get a rough idea of when each part should be replaced. For the replacement of parts, contact the service network or your supplier. (Operation hours can be known by alarm output, if it is set. For more details, refer to Section 6.26.11.)

Standard replacement cycles of principal parts

The table below provides a listing of the replacement cycles of parts when used under normal conditions (average ambient temperature: 40°C, load factor: not more than 80%, operation time: 12 hours per day). The replacement cycle of each part does not mean its service life but the number of years over which its failure rate does not increase significantly.

Part name		Standard replacement cycle	Replacement mode and others
Cooling fan	(200V/75kW models and 400V/110kW models or smaller)	5 years	Replacement with a new one
	(200V/90kW models and 400V/132kW models or larger)	5 years (Inside air cooling fan) 10 years (Outside air cooling fan)	Replacement with a new one
Smoothing capacitor		5 years	Replace with a new one (depending on the check results)
Circuit breaker and relays		-	Whether to replace or not depends on the check results
Aluminum capacitor on printed circuit board		5 years	Replace with a new circuit board (depending on the check results)

Note: The life of a part greatly varies depending on the environment of use. Do not install in any location where there are large amounts of dust, metallic fragments and oil mist.

14.3 Making a call for servicing

For the Toshiba service network, refer to the back cover of this instruction manual. If defective conditions are encountered, please contact the Toshiba service section in charge via your Toshiba dealer.

When making a call for servicing, please inform us of the contents of the rating label on the right panel of the inverter, the presence or absence of optional devices, etc., in addition to the details of the failure.

14.4 Keeping the inverter in storage

Take the following precautions when keeping the inverter in storage temporarily or for a long period of time.

1. Store the inverter in a well-ventilated place away from heat, damp, dust and metal powder.
(storage temperature: -25~+70°C)

2. If no power is supplied to the inverter for a long time, the performance of its large-capacity electrolytic capacitor declines.

When leaving the inverter unused for a long time, supply it with electricity once every two years, for 5 hours or more each, to recover the performance of the large-capacity electrolytic capacitor. And also check the function of the inverter. It is advisable not to supply the commercial power directly to the inverter but to gradually increase the power supply voltage with a transformer, etc.



15. Warranty



Any part of the inverter that proves defective will be repaired and adjusted free of charge under the following conditions:

1. This warranty applies only to the inverter main unit.
2. Any part of the inverter which fails or is damaged under normal use within twelve months from the date of delivery shall be repaired free of charge.
3. For the following kinds of failure or damage, the repair cost shall be borne by the customer even within the warranty period.
 - Failure or damage caused by improper or incorrect use or handling, or unauthorized repair or modification of the inverter
 - Failure or damage caused by the inverter falling or an accident during transportation after the purchase
 - Failure or damage caused by fire, salty water or wind, corrosive gas, earthquake, storm or flood, lightning, abnormal voltage supply, or other natural disasters
 - Failure or damage caused by the use of the inverter for any purpose or application other than the intended one
4. All expenses incurred by Toshiba for on-site services shall be charged to the customer, unless a service contract is signed beforehand between the customer and Toshiba, in which case the service contract has priority over this warranty.

16. Disposal of the inverter

 Warning	
 Mandatory	<ul style="list-style-type: none">• For safety's sake, do not dispose of the disused inverter yourself but ask an industrial waste disposal agent (*). If the collection, transport and disposal of industrial waste is done by someone who is not licensed for that job, it is a punishable violation of the law. (Laws in regard to cleaning and processing of waste materials) <p>(*) Persons who specialize in the processing of waste and known as "industrial waste product collectors and transporters" or "industrial waste disposal persons."</p>

When disposing a used inverter, pay heed to the following points.

Blasting during incineration : There is a danger that electrolytic condensers used in the inverter may burst if it is burnt in an incinerator, because electrolyte inside the condenser expands with heat. Be careful of blasting of electrolytic condensers.

Plastics : Plastics used as covers of the inverter and so on generate poisonous gas when the inverter burnt. When burning the inverter, be careful of such poisonous gas.

Disposing manner : Be sure to dispose the inverter properly as an industrial waste.