

**Autonics**

**Photoelectric Sensor for PCB Detection**  
**BJP SERIES**  
**INSTRUCTION MANUAL**



Thank you for choosing our Autonics product.  
Please read the following safety considerations before use.

**Safety Considerations**

⚠ Please observe all safety considerations for safe and proper product operation to avoid hazards.  
⚠ symbol represents caution due to special circumstances in which hazards may occur.

**Warning** Failure to follow these instructions may result in serious injury or death.  
**Caution** Failure to follow these instructions may result in personal injury or product damage.

**Warning**

- Fail-safe device must be installed when using the unit with machinery that may cause serious injury or substantial economic loss.** (e.g. nuclear power control, medical equipment, ships, vehicles, railways, aircraft, combustion apparatus, safety equipment, crime/disaster prevention devices, etc.)  
Failure to follow this instruction may result in fire, personal injury, or economic loss.
- Do not disassemble or modify the unit.**  
Failure to follow this instruction may result in fire.
- Do not connect, repair, or inspect the unit while connected to a power source.**  
Failure to follow this instruction may result in fire.
- Check 'Connections' before wiring.**  
Failure to follow this instruction may result in fire.

**Caution**

- Use the unit within the rated specifications.**  
Failure to follow this instruction may result in fire or product damage.
- Use dry cloth to clean the unit, and do not use water or organic solvent.**  
Failure to follow this instruction may result in fire.
- Do not use the unit in the place where flammable/explosive/corrosive gas, humidity, direct sunlight, radiant heat, vibration, impact, or salinity may be present.**  
Failure to follow this instruction may result in fire or explosion.

**Model**

Model	Application	Sensing distance	Sensing type	Power supply	Output type	Control output
BJP100-BDT	For PCB detection	100mm	BGS reflective type	12-24 VDC	Transistor output	NPN open collector output
BJP100-BDT-P						PNP open collector output

**Operation Mode**

Operation mode	Light ON	Dark ON
Receiver operation	Received light Interrupted light	Received light Interrupted light
Operation indicator (red LED)	ON OFF	ON OFF
Transistor output	ON OFF	ON OFF

⚠ The above specifications are subject to change and some models may be discontinued without notice.  
⚠ Be sure to follow cautions written in the instruction manual and the technical descriptions (catalog, homepage).

**Specifications**

Model	NPN open collector output	BJP100-BDT
	PNP open collector output	BJP100-BDT-P
Sensing type	BGS reflective	
Sensing distance*1	10 to 100mm (at setting distance: 100mm)	
Available setting distance*1	20 to 100mm	
Hysteresis*1	Max. 10% of setting distance	
Sensing target	Opaque	
Response time	Max. 1.5ms	
Power supply	12-24VDC±10% (ripple P-P: max. 10%)	
Current consumption	Max. 30mA	
Light source	Red LED (660nm)	
Distance setting	Distance setting adjuster	
Operation mode	Light ON/Dark ON selectable by switch	
Control output	NPN or PNP open collector output • Load voltage: max. 26.4VDC±5% • Load current: max. 100mA • Residual voltage - NPN: max. 1VDC±5%, PNP: max. 2VDC	
Protection circuit	Power reverse polarity protection circuit, output short over current protection circuit	
Indicator	Operation indicator: red LED, stability indicator: green LED	
Connection	Cable type	
Insulation resistance	Over 20MΩ (at 500VDC megger)	
Noise immunity	±240V of square wave noise (pulse width: 1 μs) by the noise simulator	
Dielectric strength	1,000VAC at 50/60Hz for 1min	
Vibration	1.5mm amplitude at 10 to 55Hz frequency in each X, Y, Z direction for 2 hours	
Shock	500m/s <sup>2</sup> (approx. 50G) in each X, Y, Z direction for 3 times	
Environment	Ambient illu.	Sunlight: max. 10,000lx, incandescent lamp: max. 3,000lx (receiver illumination)
	Ambient temp.	-20 to 55°C, storage: -40 to 70°C
	Ambient humi.	35 to 85%RH, storage: 35 to 85%RH
Protection structure	IP65 (IEC standard)	
Material	Case: polycarbonate+acrylonitrile butadiene styrene, LED indicator: polycarbonate, sensing part: polymethyl methacrylate	
Cable	Ø3.5mm, 3-wire, 2m (AWG 24, core wire diameter: 0.08 mm, no. of core wires: 40, insulator diameter: Ø1mm)	
Accessories	Adjustment screwdriver, bracket A, M3 bolts: 2, M3 nuts: 2	
Approval	CE	
Weight*2	Approx. 105g (approx. 50g)	

\*1: Non-glossy white paper 100×100mm.  
\*2: The weight includes packaging. The weight in parenthesis is for unit only.  
\*Beam spot size is approx. 30×3mm (width×height, at distance: 30mm).  
\*The temperature and humidity of environment resistance is rated at non-freezing or condensation.

**Connections**

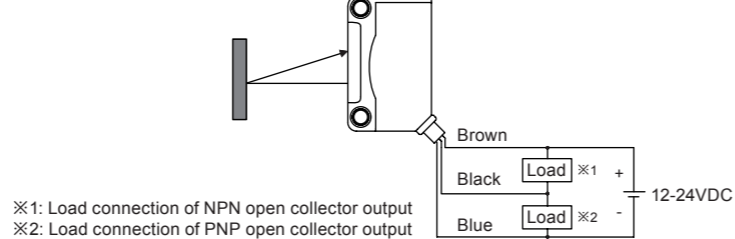

**Dimensions**

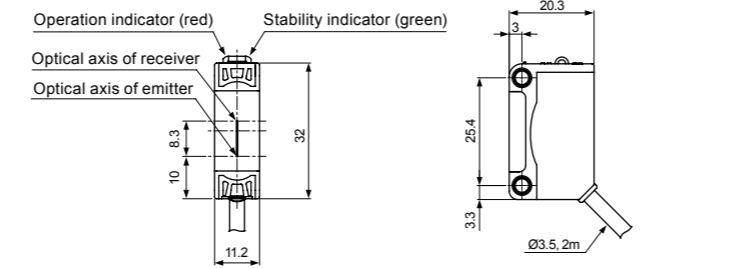

**Bracket A**

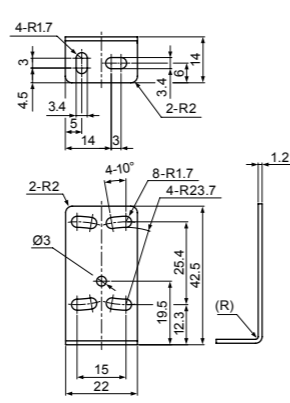

**Bracket B (BK-BJP-B, sold separately)**

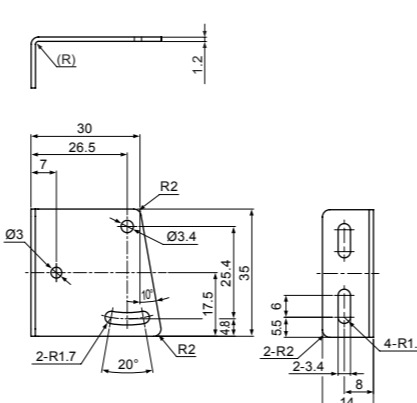

**Installation and Adjustment**

**For mounting**

- When using photoelectric sensors closely over three units, it may result in malfunction due to mutual interference. When installing the product, tighten the screw with a tightening torque of 0.5Nm.
- Exercise caution. Do not apply excessive impact to the unit or bend the cable section. The inside unit may be wet.
- The sensing side of the unit and the surface of the target object should be parallel when installed.

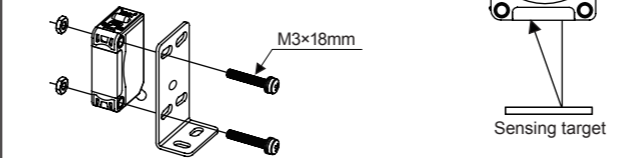

- If the sensing target has a glossy surface, mount the sensor at a 5 to 10° angle as shown in the figure. Check to see that there is no influence from background objects.
- If there is a reflective surface beneath the sensor, the reflected light may reflect off the surface of the reflective object. Make sure that the sensor is tilted upwards as shown in the figure, or install the sensor distant to the reflective surface.

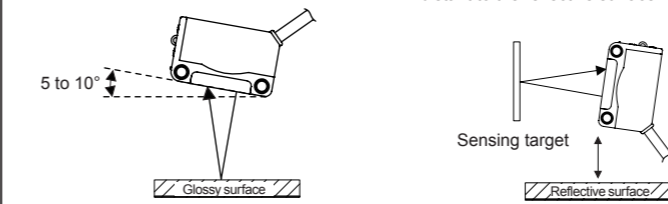

**Optical axis adjustment**

- Place the sensing target. Move the sensor slightly in each direction and check the operation of the stability indicator. Fix the sensor at the center point.

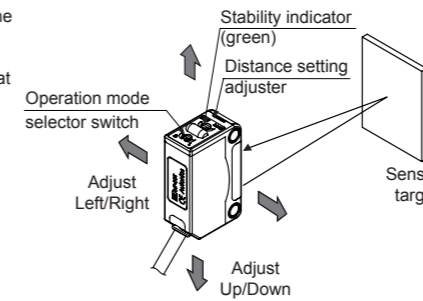

**Operation mode switching**

Light ON		Turn the operation mode selector switch all the way to the right (towards L) to select Light ON operation.
Dark ON		Turn the operation mode selector switch all the way to the left (towards D) to select Dark ON operation.

**Distance setting**

Order	Distance setting	Description
1		From Light ON status, turn the distance setting adjuster slowly to the right from MIN distance and check the position where operation indicator turns on (A).
2		From Dark ON status, turn the distance setting adjuster further right and check the position where the operation indicator turns on (B). Turn the adjuster left and check the position where the operation indicator turns off (C). ⚠ If the operation indicator does not turn on at MAX distance, the maximum setting distance is set at position (C).
3		Set the adjuster at the center position between (A) and (C) for optimal sensitivity. Also, check if the stability indicator turns off with or without the sensing target. If it does not turn off, please review the operation mode again, as sensitivity may be unstable.

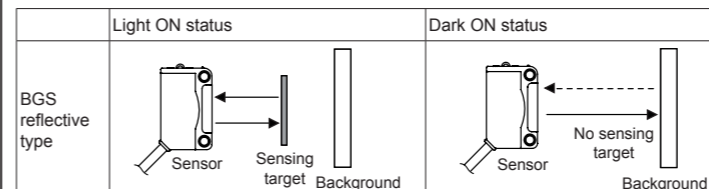

⚠ Set the distance setting within stable Light ON range for increased environmental (temperature, voltage, dust, etc.) resistance after installation.  
⚠ Do not use excessive force when turning the operation selector or distance setting adjuster. It may cause product damage.

**Control Output Circuit Diagram**

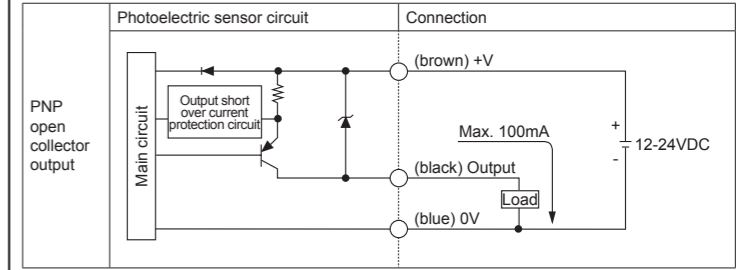
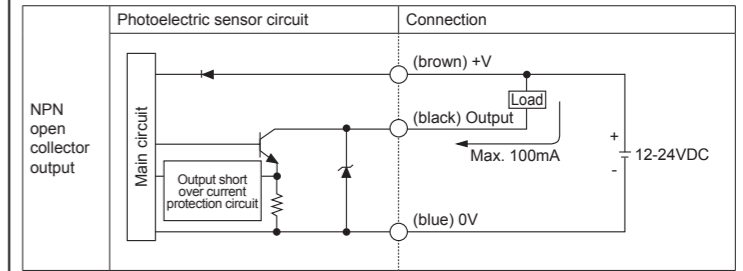

⚠ If short-circuit the control output terminal or supply current over the rated specification, normal control signal is not output due to the output short over current protection circuit.

**Operation Timing Diagram**

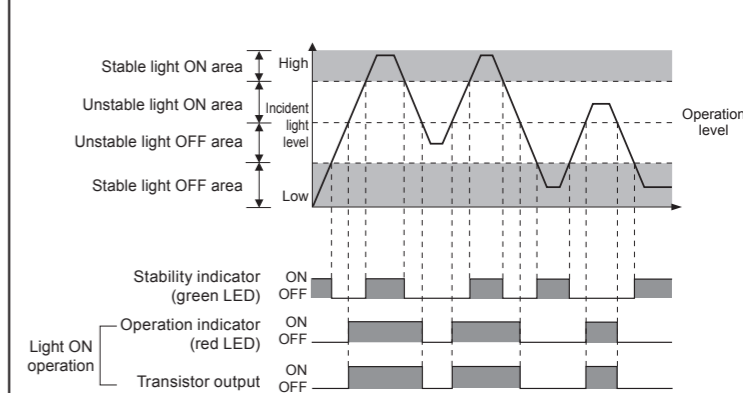

⚠ The waveforms of 'Operation indicator' and 'Transistor output' are for Light ON operation. The waveforms are reversed for Dark ON operation.

**Cautions during Use**

- Follow instructions in 'Cautions during Use'. Otherwise, it may cause unexpected accidents.
- When connecting a DC relay or other inductive load to the output, remove surge by using diodes or varistors.
- Use the product, 0.5 sec after supplying power.  
When using separate power supply for the sensor and load, supply power to sensor first.
- 12-24VDC power supply should be insulated and limited voltage/current or Class 2, SELV power supply device.
- Wire as short as possible and keep away from high voltage lines or power lines, to prevent inductive noise.
- When using switching mode power supply to supply the power, ground F.G. terminal and connect a condenser between 0V and F.G. terminal to remove noise.
- When using sensor with the equipment which generates noise (switching regulator, inverter, servo motor, etc.), ground F.G. terminal of the equipment.
- This unit may be used in the following environments.
  - ① Indoors (in the environment condition rated in 'Specifications')
  - ② Altitude max. 2,000m
  - ③ Pollution degree 3
  - ④ Installation category II

**Major Products**

- Photoelectric Sensors
- Fiber Optic Sensors
- Door Sensors
- Door Side Sensors
- Area Sensors
- Proximity Sensors
- Pressure Sensors
- Rotary Encoders
- Connectors/sockets
- Switching Mode Power Supplies
- Control Switches/Lamps/Buzzers
- I/O Terminal Blocks & Cables
- Stepper Motors/Drivers/Motion Controllers
- Graphic/Logic Panels
- Field Network Devices
- Laser Marking System (Fiber, CO<sub>2</sub>, Nd: YAG)
- Laser Welding/Cutting System
- Temperature Controllers
- Temperature/Humidity Transducers
- SSRs/Power Controllers
- Counters
- Timers
- Panel Meters
- Tachometers/Pulse (Rate) Meters
- Display Units
- Sensor Controllers

**Autonics Corporation**  
http://www.autonics.com

HEADQUARTERS:  
18, Bansong-ro 513beon-gil, Haeundae-gu, Busan, South Korea, 48002  
TEL: 82-51-519-3232  
E-mail: sales@autonics.com