

Autonics

8 Pin PLUG TYPE ANALOG TIMER ATE8 SERIES

INSTRUCTION MANUAL



Thank you for choosing our Autonics product.
Please read the following safety considerations before use.

■ Safety Considerations

- ※ Please observe all safety considerations for safe and proper product operation to avoid hazards.
- ※ Safety considerations are categorized as follows.
- Warning** Failure to follow these instructions may result in serious injury or death.
- Caution** Failure to follow these instructions may result in personal injury or product damage.
- ※ The symbols used on the product and instruction manual represent the following
- ▲ symbol represents caution due to special circumstances in which hazards may occur.

▲ Warning

- Fail-safe device must be installed when using the unit with machinery that may cause serious injury or substantial economic loss.** (e.g. nuclear power control, medical equipment, ships, vehicles, railways, aircraft, combustion apparatus, safety equipment, crime/disaster prevention devices, etc.) Failure to follow this instruction may result in personal injury, fire, or economic loss.
- The unit must be installed on a device panel before use.** Failure to follow this instruction may result in electric shock.
- Do not connect, repair, or inspect the unit while connected to a power source.** Failure to follow this instruction may result in electric shock.
- Do not disassemble or modify the unit. Please contact us if necessary.** Failure to follow this instruction may result in electric shock or fire.

▲ Caution

- Do not use the unit outdoors.** Failure to follow this instruction may result in shortening the life cycle of the unit, or electric shock.
- Use the unit within the rated specifications.** Failure to follow this instruction may result in shortening the life cycle of the unit, or fire.
- Do not use loads beyond the rated switching capacity of the relay contact.** Failure to follow this instruction may result in insulation failure, contact failure, contact bonding, relay damage, or fire.
- Do not use water or oil-based detergent when cleaning the unit. Use dry cloth to clean the unit.** Failure to follow these instructions may result in electric shock or fire.
- Do not use the unit where flammable or explosive gas, humidity, direct sunlight, radiant heat, vibration, and impact may be present.** Failure to follow this instruction may result in fire or explosion.
- Keep dust and wire residue from flowing into the unit.** Failure to follow this instruction may result in fire or product damage.

■ Ordering Information

ATE	8	—	4	3	D
Item	Number of plug pins	Power supply	Time range	Control output	
※ Sockets (PG-08, PS-08 (N)) are sold separately.					
				No mark	Time limit 1c+Instantaneous 1a
				D	Time limit 2c
				E	Time limit 1c+Instantaneous 1c
			1		1 sec/10 sec/1 min/10 min/1 hour
			3		3 sec/30 sec/3 min/30 min/3 hour
			6		6 sec/60 sec/6 min/60 min/6 hour
			C		12 sec/12 min/24 min/12 hour/24 hour
		4			100-240VAC 50/60Hz, 24-240VDC
		8			8-pin plug type
		ATE			Analog timer

■ Unit Description

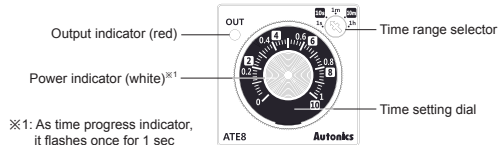

※ The above specifications are subject to change and some models may be discontinued without notice.

■ Specifications

Model	ATE8-4	ATE8-4 D	ATE8-4 E
Function	Power ON Delay Timer		
Control time setting range ^{※1}	0.1 sec to 24 hour		
Power supply	100-240VAC~ 50/60Hz, 24-240VDC~		
Permissible voltage range	90 to 110% of rated voltage		
Power consumption	Max. 3.5VA (100-240VAC~ 50/60Hz), Max. 2.0W (24-240VDC~)		
Return time	Max. 200ms		
Time operation	Power ON Start		
Control output	Contact type	Time-limit SPDT (1c)+ Instantaneous SPST (1a)	Time-limit DPDT (2c) / Time-limit SPDT (1c)+ Instantaneous SPDT (1c)
	Contact capacity	250VAC~ 3A resistive load	
Relay	Mechanical	Min. 5,000,000 operations	
life cycle	Electrical	Min. 100,000 operations (250VAC 3A resistive load)	
Repeat error	Max. ±0.3% ±0.01 sec		
Set error	Max. ±5% ±0.05 sec		
Voltage error	Max. ±0.5% ±0.01 sec		
Temp. error	Max. ±2% ±0.01 sec		
Insulation resistance	Over 100MΩ (at 500VDC megger)		
Dielectric strength	2,000VAC 50/60Hz for 1 min		
Noise immunity	±2kV the square wave noise (pulse width 1μs) by noise simulator		
Vibration	Mechanical	0.75mm amplitude at frequency 10 to 55Hz (for 1 min) in each X, Y, Z direction for 1 hour	
	Malfunction	0.5mm amplitude at frequency 10 to 55Hz (for 1 min) in each X, Y, Z direction for 10 min	
Shock	Mechanical	300m/s ² (approx. 30G) in each X, Y, Z direction for 3 times	
	Malfunction	100m/s ² (approx. 10G) in each X, Y, Z direction for 3 times	
Environment	Ambient temp.	-10 to 55°C, storage: -25 to 65°C	
	Ambient humid.	35 to 85%RH, storage: 35 to 85%RH	
Protection structure	IP40 (front part, IEC standard)		
Approval	CE, ENEC, UL		
Weight ^{※2}	Approx. 122.2g (approx. 75g)		

- ※1: Refer to time specifications for control time setting range by model.
- ※2: The weight includes packaging. The weight in parenthesis is for unit only.
- ※ Environment resistance is rated at no freezing or condensation.

■ Time Specifications

Model	Time range	Time unit	Time setting range	Model	Time range	Time unit	Time setting range
ATE8-41	1	s	0.1 to 1 sec	ATE8-46	6	s	0.6 to 6 sec
	10	s	1 to 10 sec		60	s	6 to 60 sec
	1	m	0.1 to 1 min		6	m	0.6 to 6 min
ATE8-43	1	m	1 to 10 min	ATE8-4C	6	m	6 to 60 min
	1	h	0.1 to 1 hour		6	h	0.6 to 6 hour
	3	s	0.3 to 3 sec		12	s	1.2 to 12 sec
ATE8-43	30	s	3 to 30 sec	ATE8-4C	12	m	1.2 to 12 min
	3	m	0.3 to 3 min		24	m	2.4 to 24 min
	30	m	3 to 30 min		12	h	1.2 to 12 hour
ATE8-43	3	h	0.3 to 3 hour	ATE8-4C	24	h	2.4 to 24 hour

■ Dimensions

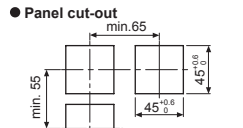
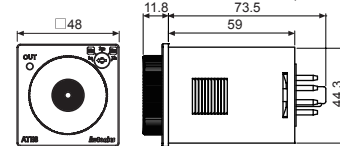

■ Bracket (sold separately)(BK-S)

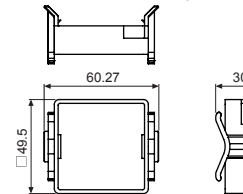

■ Connections

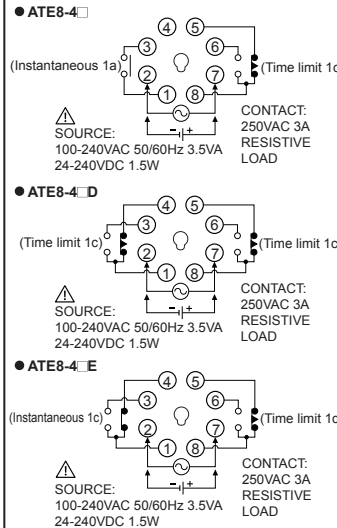

■ Operation Mode

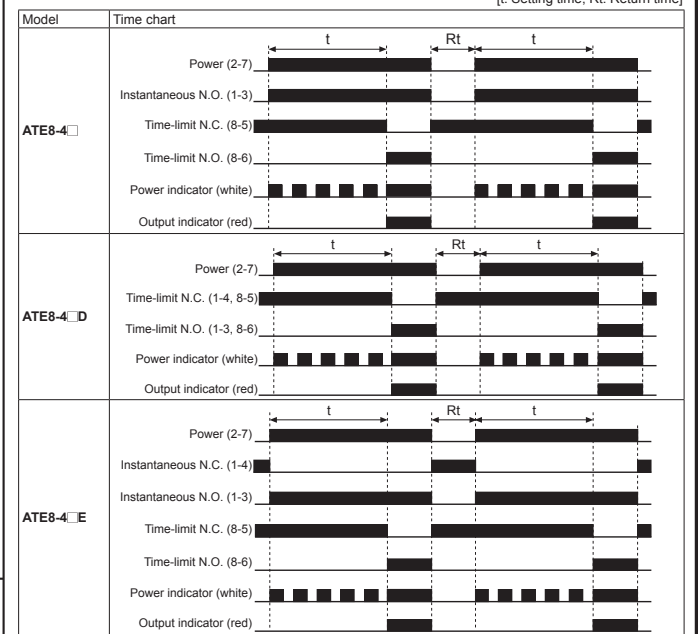

※ When time-limit of ATE8-4, ATE8-4 D, ATE8-4 E is set to 0, time-limit contact operates within 30ms right after instantaneous contact operation.

■ Cautions during Use

- When supplying the power to the timer, use switch, or relay, etc for instant supply. When supplying power slowly, it may cause malfunction.
- When supply the power to the timer, connection shown in (Fig. 1) might cause malfunction due to circuitous leakage current through resistance (R) and condenser (C). Please connect resistance (R) and condenser (C) as shown in (Fig. 2) to prevent malfunction due to circuitous leakage current.

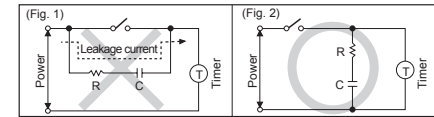

- Connect bipolar output contacts as potential.
 - Testing dielectric voltage or insulation resistance when the unit is installed at control panel
 - ① Isolate the unit from the circuit of control panel.
 - ② Short all terminals of the unit.
 - Do not use the unit in the following environments.
 - ① Environments with high vibration or shock.
 - ② Environments with strong alkali or strong acid materials
 - ③ Environments with exposure to direct sunlight
 - ④ Near machinery which produces strong magnetic force or electric noise
 - This product may be used in the following environments.
 - ① Indoor
 - ② Altitude max. 2,000m
 - ③ Pollution degree 2
 - ④ Installation category II
- ※ Failure to follow these instructions may result in product damage.

■ Major Products

- Photoelectric Sensors
- Fiber Optic Sensors
- Door Sensors
- Door Side Sensors
- Area Sensors
- Proximity Sensors
- Pressure Sensors
- Rotary Encoders
- Connectors/sockets
- Switching Mode Power Supplies
- Control Switches/Lamps/Buzzers
- I/O Terminal Blocks & Cables
- Stepper Motors/Drivers/Motion Controllers
- Graphic/Logic Panels
- Field Network Devices
- Laser Marking System (Fiber, Co., Nd: YAG)
- Laser Welding/Cutting System
- Temperature Controllers
- Temperature/Humidity Transducers
- SSRs/Power Controllers
- Counters
- Timers
- Panel Meters
- Tachometers/Pulse (Rate) Meters
- Display Units
- Sensor Controllers

Autonics Corporation
http://www.autonics.com

■ HEADQUARTERS:
18, Bansong-ro 513beon-gil, Haeundae-gu, Busan, South Korea, 48002
TEL: 82-51-519-3232
■ E-mail: sales@autonics.com