

Autonics

DIGITAL PANEL METER M4W SERIES

M A N U A L



Thank you very much for selecting Autonics products.
For your safety, please read the following before using.

Caution for your safety

- ※ Please keep these instructions and review them before using this unit.
- ※ Please observe the cautions that follow:
- Warning** Serious injury may result if instructions are not followed.
- Caution** Product may be damaged, or injury may result if instructions are not followed.
- ※ The following is an explanation of the symbols used in the operation manual.
⚠ caution: Injury or danger may occur under special conditions.

Warning

- In case of using this unit with machineries (Nuclear power control, medical equipment, vehicle, train, airplane, combustion apparatus, entertainment or safety device etc), it requires installing fail-safe device, or contact us for information on type required. It may result in serious damage, fire or human injury.
- It must be mounted on panel. It may give an electric shock.
- Do not repair or check up when power on. It may give an electric shock.
- Do not disassemble and modify this unit, when it requires. If needs, please contact us. It may give an electric shock and cause a fire.
- Please check the number of terminal when connect power line or measuring input. It may cause a fire.

Caution

- This unit shall not be used outdoors. It might shorten the life cycle of the product or give an electric shock.
- When wire connection, AWG 20(0.50mm²) should be used and screw bolt on terminal block with 0.74N·m to 0.90N·m strength. It may result in malfunction or fire due to contact failure.
- Please observe specification rating. It might shorten the life cycle of the product and cause a fire.
- Do not use the load beyond rated switching capacity of Relay contact. It may cause insulation failure, contact melt, contact failure, relay broken, fire etc.
- In cleaning the unit, do not use water or an oil-based detergent. It might cause an electric shock or fire that will result in damage to this product.
- Do not use this unit at place where there are flammable or explosive gas, humidity, direct ray the sun, radiant heat, vibration, impact etc. It may cause explosion.
- Do not inflow dust or wire dregs into inside of this unit. It may cause a fire or mechanical trouble.
- Please connect properly after checking the polarity of measuring terminals. It may cause a fire or explosion.

Dimensions

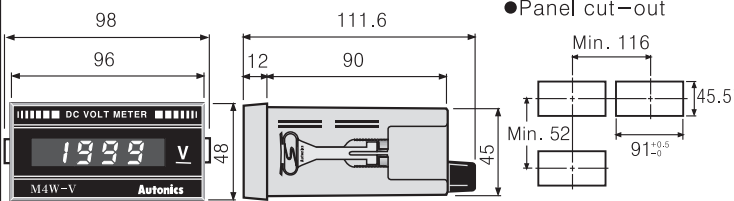

※ The above specifications are subject to change and some models may be discontinued without notice.

Specifications

Model	M4W-AV-□	M4W-DV-□	M4W-AA-□	M4W-DA-□	M4W-W-□	M4W-T-□-□	M4W-S-□-□	M4W-DI	M4W-DI	M4W-P
Max. allowable input	Max. 400VAC	Max. 300VDC	Max. AC5A	Max. DC2A	Max. 10VDC	Max. 10VDC, Max. 10VAC	DC4-20mA	DC4-20mA	DC4-20mA	DC4-20mA
Max. display range	150% for each input specification (At AC400V:120%)									-0.50 to 1.00 to +0.50cosφ
Measurement function	AC Voltage	DC Voltage	AC Ampere	DC Ampere	AC Watt	rpm	Speed	Scaling Meter	Power factor	
Power supply	110/220VAC 50/60Hz (Option: 100-240VAC 50/60Hz, 24-70VDC)									
Allowable voltage range	90 to 110% of rated voltage									
Power consumption	M4W-DC: 2W, AC: 4VA / M4W1P, 2P-DC: 3W, AC: 5VA									
Display method	7Segment LED Display (Character height: 14mm)									
Sampling cycle	300ms									
A/D conversion method	Dual slope intergal method									
Response time	2sec. (0 to Max.)									
Sampling times	2.5 times/sec.									
Insulation resistance	Min. 100MΩ (at 500VDC megger)									
Dielectric strength	2000VAC 50/60Hz for 1 minute									
Noise strength	±1kV the square wave noise (pulse width: 1μs) by the noise simulator									
Vibration	Mechanical	0.75mm amplitude at frequency of 10 to 55Hz in each of X, Y, Z directions for 1 hour								
	Malfunction	0.5mm amplitude at frequency of 10 to 55Hz in each of X, Y, Z directions for 10 minutes								
Shock	Mechanical	300m/s ² (Approx. 30G) 3 times at X, Y, Z direction								
	Malfunction	100m/s ² (Approx. 10G) 3 times at X, Y, Z direction								
Environ-ment	Ambient temperature	-10 to 50°C, Storage temperature: -25 to 65°C								
	Ambient humidity	35 to 85%RH, Storage humidity: 35 to 85%RH								
Relay life cycle	Mechanical	Min. 10,000,000 times								
	Electrical	Min. 100,000 times (250VAC 3A resistive load)								
Output capacity	M4W: Non, M4W1P: Relay contact output 250VAC 3A 1c, M4W2P: Relay contact output 250VAC 3A 1c x 2									
Display accuracy	DC: F.S. ±0.2% rdg ±1Digit 23°C ±5°C			AC: F.S. ±0.5% rdg ±2Digit 23°C ±5°C			F.S. ±0.3% rdg ±1Digit 23°C ±5°C			F.S. ±3% rdg ±1Digit
Weight	M4W: Approx. 168g, M4W-P: Approx. 268g, M4W1P: Approx. 253g, M4W2P: Approx. 278g									

※ Environment resistance is rated at no freezing or condensation.

Ordering information

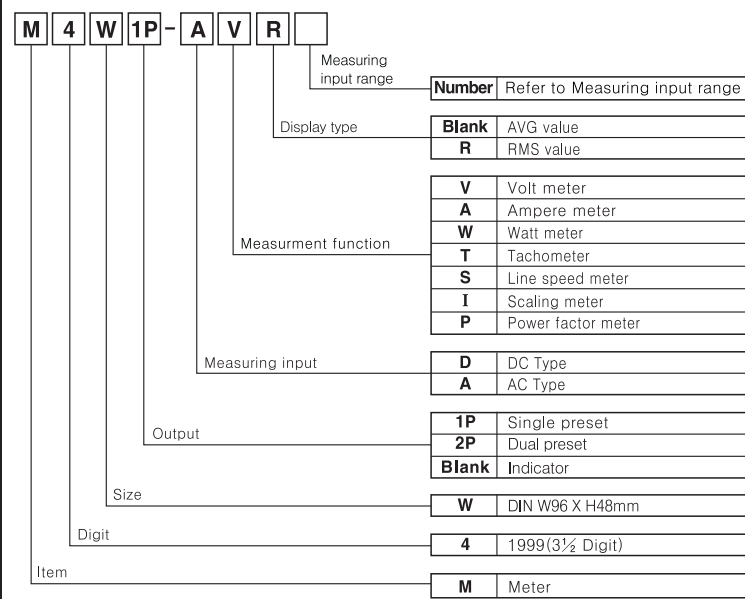

Measuring input range

Range Model	Blank	1	2	3	4	5	6	7	8	X
AV(R)	-	199.9mV	1.999V	19.99V	199.9V	-	400V	-	-	Option
AA(R)	-	19.99mA	199.9mA	1.999A	19.99A	199.9A	1999A	-	-	Option
DV	-	199.9mV	1.999V	19.99V	199.9V	300V	-	-	-	Option
DA	-	199.9μA	1.999mA	19.99mA	199.9mA	1.999A	19.99A	199.9A	1999A	Option
W*1	-	199.9W	1.999kW	19.99kW	199.9kW	1999kW	-	-	-	Option
T(R)	-	1999rpm	1999rpm	-	-	-	-	-	-	Option
S	-	1999 m/min	1999 m/min	-	-	-	-	-	-	Option
DI*2	1999	-	-	-	-	-	-	-	-	Option
P	-	-0.50-1.00-+0.50	-	-	-	-	-	-	-	Option

- ※ 1: When the output of power converter is 10VDC, measuring input value is maximum. In case that output is DC4-20mA, scaling meter should be used.
- ※ 2: 1-5VDC measuring input is optional.
- ※ Power converter should be used with Watt meter and Tachometer/Line speed meter should be used with Tacho-generator.

Connections

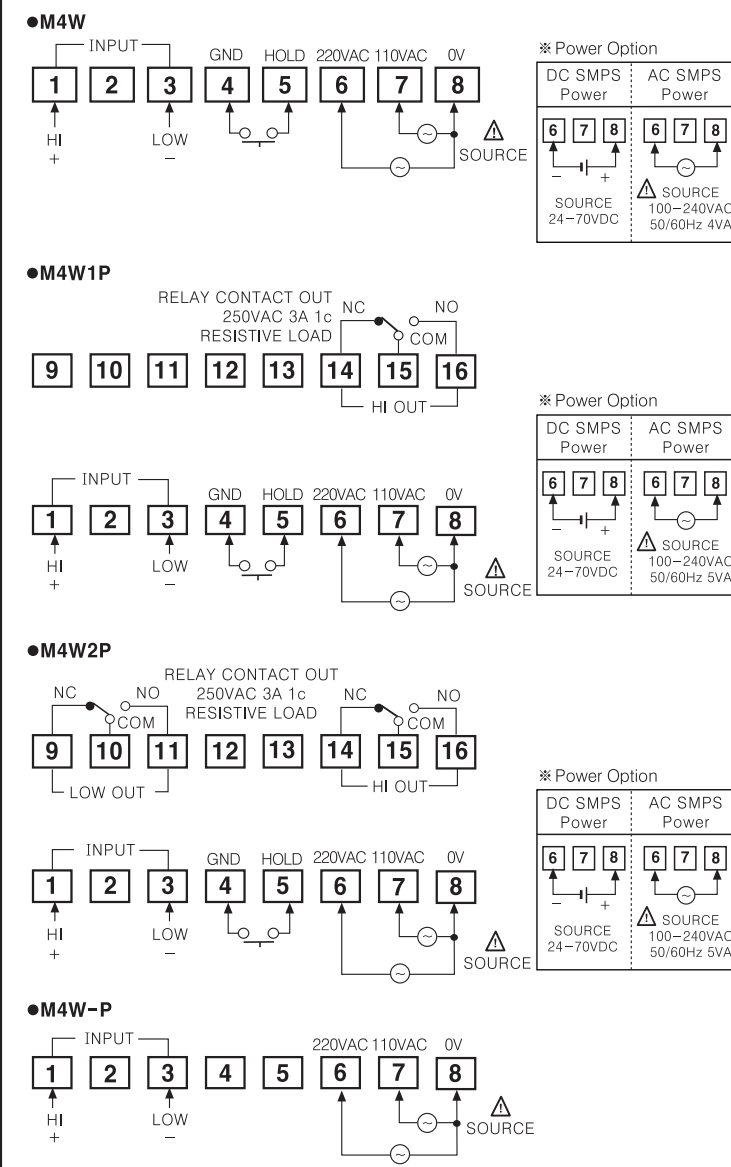

General block diagram

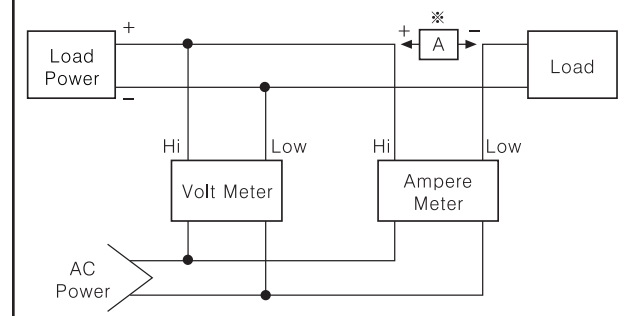

※ When measure over DC2A, please use Shunt and measure over AC5A, please use C.T. (Current Transformer).

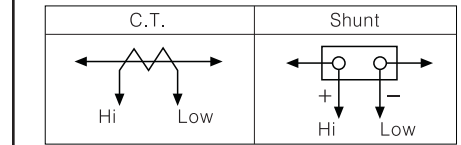

Caution for using

- Please use the terminal (Pitch: 7.2mm max.) when connecting the AC power supply.
- Please use separated line from high voltage line or power line in order to avoid inductive noise.
- Please use power switch or circuit breaker in order to turn OFF the power.
- The switch or circuit breaker should be installed near by users for safety.
- Be sure to avoid using this unit near by machinery makes strong high frequency noise. (Welding machine, high capacity SCR unit etc.)
- When input applied, if "1999" or "1999" are displayed, it has some trouble with measuring input, please check the line after power off.
- Noise inflow from power line can be serious problem for products driving of D.P.M. (Digital panel meter) by AC power. Even though there is condenser for protecting noise between lines in power transformer, but as small size product, it is very difficult to install protection components. Therefore, please install line filter, varistor or noise absorber in external lines when voltage failure occurred by power relay or magnet S/W operation, spark with high voltage.

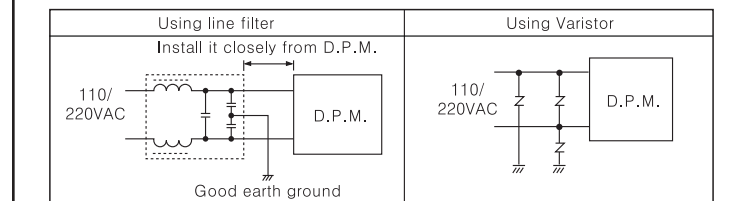

- Input line: Shield wire must be used when the measuring input line is getting longer or there are lots of noises.

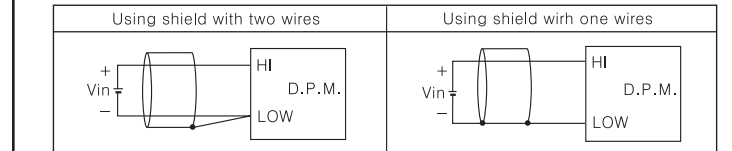

Installation environment

- It shall be used indoor
- Altitude Max. 2000m
- Pollution Degree 2
- Installation Category II.

※ It may cause malfunction if above instructions are not followed.

Main products

- Photoelectric sensors
- Fiber optic sensors
- Door sensors
- Door side sensors
- Area sensors
- Proximity sensors
- Pressure sensors
- Rotary encoders
- Connector/Sockets
- Switching mode power supplies
- Control switches/Lamps/Buzzers
- I/O Terminal Blocks & Cables
- Stepper motors/drivers/motion controllers
- Graphic/Logic panels
- Field network devices
- Laser marking system(Fiber, CO₂, Nd:YAG)
- Laser welding/soldering system
- Temperature controllers
- Temperature/Humidity transducers
- SSR/Power controllers
- Counters
- Timers
- Panel meters
- Tachometer/Pulse(Rate) meters
- Display units
- Sensor controllers

Autonics Corporation
http://www.autonics.com

Satisfiable Partner For Factory Automation

HEAD QUARTERS:
18, Bansong-ro 513beon-gil, Haeundae-gu, Busan, Korea

OVERSEAS SALES:
#402-404, Bucheon Techno Park, 655, Pyeongcheon-ro, Wornji-gu, Bucheon, Gyeonggi-do, Korea
TEL: 82-32-610-2730 / FAX: 82-32-329-0728
E-mail: sales@autonics.com