

Power Relay

TAKAMISAWA (Fujitsu) Power Relay 1 POLE-5A NYP24W-K

■ Features

- Slim type with 5mm thickness
- Low power consumption and high sensitivity



■ Coil Specifications

Model	Rated voltage	Must operate voltage	Must release voltage	Rated current	Coil resistance	Power consumption
NYP24W-K	24VDC	16.1V	2.4V	5mA	4,800Ω	120mW

※All values in the table are measured at 20 °C with a tolerance of ±10%.

■ Contact Specifications

Manufacture		TAKAMISAWA (Fujitsu)			
Model		NYP24W-K			
Contact	Arrangement	1 Form A (SPST-1a)			
	Material	Gold overlay silver alloy			
	Resistance (initial)	30mΩ (6VDC 1A)			
Rating	Rated load	3A 250VAC	3A 30VDC		
	Max. switching capacity	750VA	90W		
	Min. switching capacity	5VDC 1mA			
	Max. switching voltage	270VAC	150VDC		
	Max. switching current	5A			
Electrical characteristics	Insulation resistance	Min. 1,000MΩ (at 500VDC megger)			
	Dielectric strength	Between contact-coil	3,000VAC 50/60Hz for 1 minute		
		Between open contacts	750VAC 50/60Hz for 1 minute		
	Surge voltage	5,080V			
	Operate time	Max. 10ms			
Release time	Max. 5ms				
Mechanical characteristics	Vibration	Mechanical	5.0mm amplitude at frequency of 10 to 55 Hz (for 1 min) in each X, Y, Z direction for 1 hour		
		Malfunction	1.5mm amplitude at frequency of 10 to 55 Hz (for 1 min) in each X, Y, Z direction for 10 minute		
	Shock	Mechanical	1000m/s ² (approx. 100G) in each X, Y, Z direction for 3 times		
		Malfunction	100m/s ² (approx. 10G) in each X, Y, Z direction for 3 times		
Life expectancy	Mechanical	Min. 20,000,000 operations (at 180 operations/min)			
	Electrical ^{※1}	Min. 100,000 operations (3A 250VAC, 30VDC resistive load)			
Environment	Ambient temperature	-40 to 90°C			
	Ambient humidity	35 to 80%RH			
Weight	Approx. 3.5g				

※1: 50,000 operations: 5A 250VAC, 5A 30VDC resistive load (per 20 operations/min)

※Environment resistance is rated at no freezing or condensation.

■ Dimensions

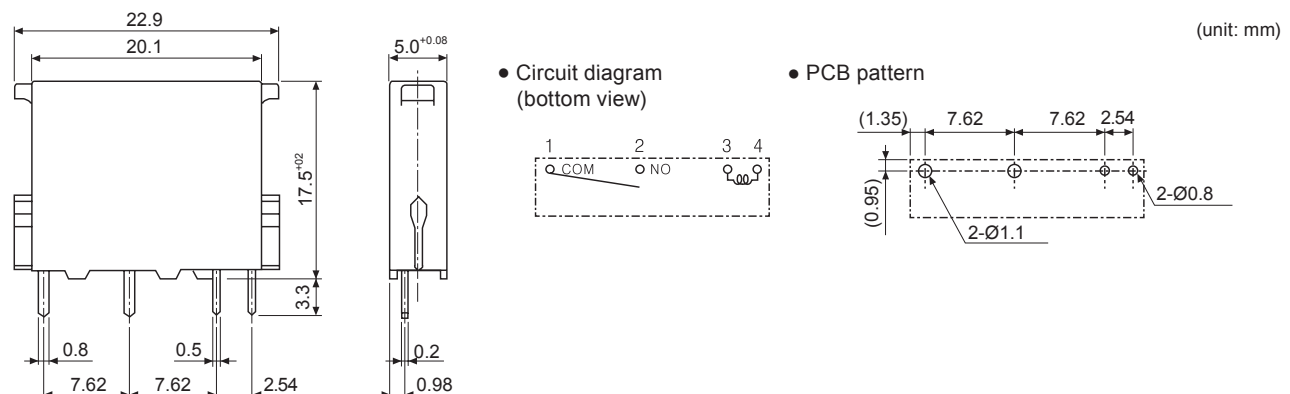

MATSUSHITA (Panasonic) Power Relay 1 POLE-5A PA1a-24V

■ Features

- Slim type with 5mm thickness
- Excellent durability resistance against vibration and shock

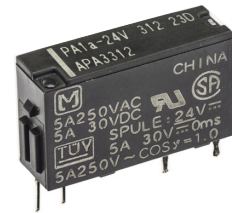

■ Coil Specifications

Model	Rated voltage	Must operate voltage	Must release voltage	Rated current	Coil resistance	Power consumption
PA1a-24V	24VDC	Min. 70% of rated voltage	Max. 70% of rated voltage	7.5mA	3,200Ω	180mW

※All values in the table are measured at 20 °C with a tolerance of ±10%.

■ Contact Specifications

Manufacture		MATSUSHITA (Panasonic)	
Model		PA1a-24V	
Contact	Arrangement	1 Form A (SPST-1a)	
	Material	Au-clad AgNi type	
	Resistance (initial)	30mΩ (6VDC 1A)	
Rating	Rated load	5A 250VAC	5A 30VDC
	Max. switching capacity	1,250VA	150W
	Min. switching capacity	100mVDC 100μA	
	Max. switching voltage	250VAC	110VDC
	Max. switching current	5A	
Electrical characteristics	Insulation resistance		Min. 1,000MΩ (at 500VDC megger)
	Dielectric strength	Between contact-coil	2,000VAC 50/60Hz for 1 minute
		Between open contacts	1,000VAC 50/60Hz for 1 minute
	Surge voltage		4,000V
	Operate time		Max. 10ms
	Release time		Max. 5ms
Mechanical characteristics	Vibration	Mechanical	3.5mm amplitude at frequency of 10 to 55 Hz (for 1 min) in each X, Y, Z direction for 1 hour
		Malfunction	2.5mm amplitude at frequency of 10 to 55 Hz (for 1 min) in each X, Y, Z direction for 10 minute
	Shock	Mechanical	980m/s ² (approx. 100G) in each X, Y, Z direction for 3 times
		Malfunction	147m/s ² (approx. 15G) in each X, Y, Z direction for 3 times
Life expectancy	Mechanical	Min. 20,000,000 operations (at 180 operations/min)	
	Electrical ^{※1}	Min. 100,000 operations (3A 250VAC, 30VDC resistive load)	
Environment	Ambient temperature	-40 to 70°C	
	Ambient humidity	5 to 85%RH	
Weight		Approx. 3g	

※1: 50,000 operations-5A 250VAC, 5A 30VDC resistive load (per 20 operations/min)

※Environment resistance is rated at no freezing or condensation.

■ Dimensions

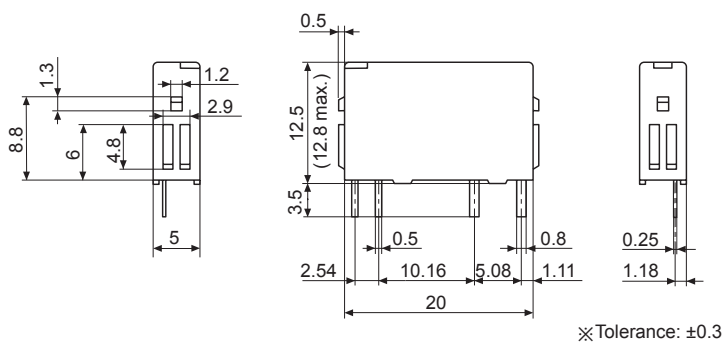

- Circuit diagram (bottom view) (unit: mm)

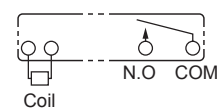

- PCB pattern

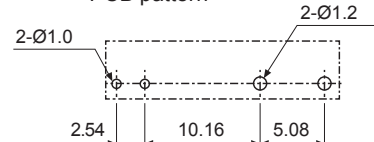

I/O Terminal Blocks

AFS(Interface Terminal Block)
AFJ/AFR(Interface Terminal Block)
ACS(Common Terminal Block)
AFE(Sensor Connector Terminal Block)
ABS(Relay Terminal Block)
ABL(Relay Terminal Block)
Power Relay

I/O Cables

MITSUBISHI
LSIS
Autonics
RS Automation
YOKOGAWA
FUJI
KDT
OMRON
TELEMECANIQUE
For SERVO
Open Type Cables
Cable Appearance

Remote I/O

ARD(DeviceNet Digital Standard Terminal Type)
ARD(DeviceNet Digital Sensor Connector Type)
ARD(DeviceNet Analog Standard Terminal Type)
ARM(Modbus Digital Sensor Connector Type)

Others

Sensor Connectors
Sockets
Sensor Distribution Boxes
Valve Plugs
Thumbwheel Switches

Power Relay

MATSUSHITA (Panasonic) Power Relay 1 POLE-5A PQ1a-24V

■ Features

- Slim type
- Excellent durability resistance against vibration and shock

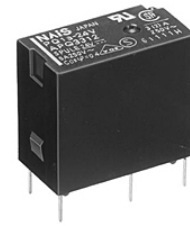

■ Coil Specifications

Model	Rated voltage	Must operate voltage	Must release voltage	Rated current	Coil resistance	Power consumption
PQ1a-24V	24VDC	Min. 75% of rated voltage	Max. 5% of rated voltage	8.3mA	2,880Ω	200mW

※All values in the table are measured at 20 °C with a tolerance of ±10%.

■ Contact Specifications

Manufacture		MATSUSHITA (Panasonic)				
Model		PQ1a-24V				
Contact	Arrangement	1 Form A (SPST-1a)				
	Material	Au-clad AgNi type				
	Resistance (initial)	50mΩ (6VDC 1A)				
Rating	Rated load (resistive load)	5A 250VAC			5A 30VDC	
	Max. switching power (resistive load)	1,250VA			150W	
	Max. switching voltage	250VAC			110VDC	
	Max. switching current	5A				
Electrical characteristics	Insulation resistance (initial)		Min. 1,000MΩ (at 500VDC megger)			
	Dielectric strength	Between contact-coil	4,000VAC 50/60Hz for 1 minute			
		Between open contacts	1,000VAC 50/60Hz for 1 minute			
	Surge voltage		8,000V			
	Operate time (supplying rated voltage)		Max. 20ms			
	Release time (supplying rated voltage)		Max. 10ms			
Mechanical characteristics	Vibration	Mechanical	3.5mm amplitude at frequency of 10 to 55 Hz (for 1 min) in each X, Y, Z direction for 1 hour			
		Malfunction	2.0mm amplitude at frequency of 10 to 55 Hz (for 1 min) in each X, Y, Z direction for 10 minute			
	Shock	Mechanical	980m/s ² (approx. 100G) in each X, Y, Z direction for 3 times			
		Malfunction	294m/s ² (approx. 15G) in each X, Y, Z direction for 3 times			
Life expectancy	Mechanical		Min. 20,000,000 operations (at 180 operations/min)			
	Electrical ^{※1}		Min. 100,000 operations (5A 250VAC, 30VDC resistive load)			
Environment	Ambient temperature		-40 to 70°C			
	Ambient humidity		5 to 85%RH			
Weight		Approx. 7g				

※1: 20 operations per 1 minute

※Environment resistance is rated at no freezing or condensation.

■ Dimensions

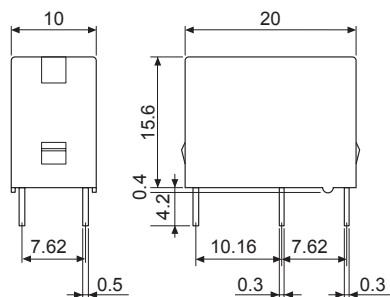

• Circuit diagram (bottom view)

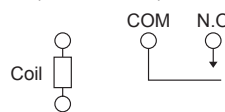

(unit: mm)

• PCB pattern

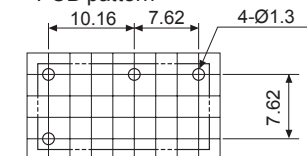

※Tolerance: ±0.1

※Tolerance: ±0.2 (Max. 1mm),
±0.3 (Min. 1mm to Max. 5mm),
±0.4 (Min. 5mm)

MATSUSHITA (Panasonic) Power Relay Plug-In Type 1 Form C

■ Features

- Slim type
- High capacity, high reliability

■ Coil Specifications

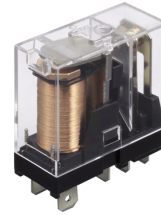

Model	Rated voltage	Must operate voltage	Must release voltage	Rated current		Power consumption	
AHN12024	24VDC	Min. 70% of rated voltage	Max. 15% of rated voltage	22mA		0.53W	
AHN110X0	100/110VAC	Min. 80% of rated voltage	Max. 30% of rated voltage	50Hz	60Hz	50Hz	60Hz
				11/13mA	9/10.6mA	1.1 to 1.4VA	0.9 to 1.2VA
AHN110Y0	200/220VAC	Min. 80% of rated voltage	Max. 30% of rated voltage	50Hz	60Hz	50Hz	60Hz
				5.5/6.5mA	4.5/5.3mA	1.1 to 1.4VA	0.9 to 1.2VA

■ Contact Specifications

Manufacture		MATSUSHITA (Panasonic)		
Model		AHN12024	AHN110X0	AHN110Y0
Contact	Arrangement	1 Form C		
	Material	AgSnO ₂ type		
	Resistance (initial)	Max. 100mΩ (6VDC 1A)		
Rating	Rated load (resistive load)	10A 250VAC, 10A 30VDC		
	Max. switching power (resistive load)	4,000VA, 300W		
	Max. switching voltage	250VAC, 30VDC		
	Max. switching current	16A (AC load), 10A (DC load)		
Electrical characteristics	Insulation resistance (initial)		Min. 1,000MΩ (at 500VDC megger)	
	Dielectric strength	Between contact-coil	5,000VAC 50/60Hz for 1 minute	
		Between open contacts	1,000VAC 50/60Hz for 1 minute	
	Operate time (supplying rated voltage)		Max. 15ms	
	Release time (supplying rated voltage)		Max. 5ms	
Mechanical characteristics	Vibration	Mechanical	1.5mm amplitude at frequency of 10 to 55 Hz (for 1 min) in each X, Y, Z direction for 1 hour	
		Malfunction	1.5mm amplitude at frequency of 10 to 55 Hz (for 1 min) in each X, Y, Z direction for 10 minute	
	Shock	Mechanical	1,000m/s ² (approx. 100G) in each X, Y, Z direction for 3 times	
		Malfunction	100m/s ² (approx. 10G) in each X, Y, Z direction for 3 times	
Life expectancy	Mechanical	Min. 20,000,000 operations (at 300 operations/min)	Min. 10,000,000 operations (at 300 operations/min)	
	Electrical	Min. 100,000 operations (at 20 operations/min)		
Environment	Ambient temperature	-40 to 70°C		
	Ambient humidity	5 to 85%RH		
Weight	Approx. 19g			

※Environment resistance is rated at no freezing or condensation.

■ Dimensions

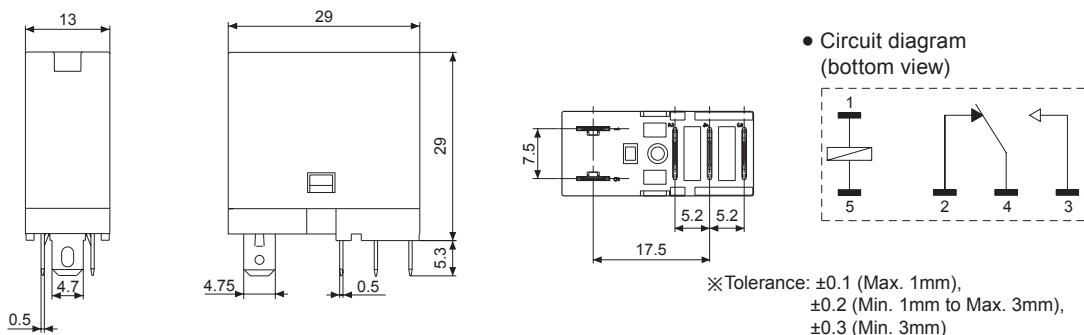

I/O Terminal Blocks

AFS(Interface Terminal Block)

AFL/AFR(Interface Terminal Block)

ACS(Common Terminal Block)

AFE(Sensor Connector Terminal Block)

ABS(Relay Terminal Block)

ABL(Relay Terminal Block)

Power Relay

I/O Cables

MITSUBISHI

LSIS

Autonics

RS Automation

YOKOGAWA

FUJI

KDT

OMRON

TELEMECANIQUE

For SERVO

Open Type Cables

Cable Appearance

Remote I/O

ARD(DeviceNet Digital Standard Terminal Type)

ARD(DeviceNet Digital Sensor Connector Type)

ARD(DeviceNet Analog Standard Terminal Type)

ARM(Modbus Digital Sensor Connector Type)

Others

Sensor Connectors

Sockets

Sensor Distribution Boxes

Valve Plugs

Thumbwheel Switches

Power Relay

OMRON Power Relay 1 Form C

■ Features

- Slim type
- High capacity, high reliability



■ Coil Specifications

Model	Rated voltage	Must operate voltage	Must release voltage	Rated current			Power consumption
G2R-1-S24VDC	24VDC	Min. 70% of rated voltage	Max. 15% of rated voltage	21.8mA			0.53W
G2R-1-S100/ (110)VAC	100/110VAC	Min. 80% of rated voltage	Max. 30% of rated voltage	50Hz	60Hz	60Hz	0.9VA
				11mA	9/10.6mA	0.9VA	
G2R-1-S200/ (220)VAC	200/220VAC	Min. 80% of rated voltage	Max. 30% of rated voltage	50Hz	60Hz	60Hz	0.9VA
				5.5/4mA	4.5/5.3mA	0.9VA	

■ Contact Specifications

Manufacture		OMRON		
Model		G2R-1-S24VDC	G2R-1-S100/ (110)VAC	G2R-1-S100/ (110)VAC
Contact	Arrangement	1 Form C		
	Material	AgSnO ₂ type		
	Resistance (initial)	Max. 100mΩ		
Rating	Rated load (resistive load)	10A 250VAC, 10A 30VDC		
	Max. switching power (resistive load)	2,500VA, 300W		
	Max. switching voltage	380VAC, 125VDC		
	Max. switching current	16A (AC load), 10A (DC load)		
Electrical characteristics	Insulation resistance (initial)		Min. 1,000MΩ (at 500VDC megger)	
	Dielectric strength	Between contact-coil	5,000VAC 50/60Hz for 1 minute	
		Between open contacts	1,000VAC 50/60Hz for 1 minute	
	Operate time (supplying rated voltage)		Max. 15ms	
	Release time (supplying rated voltage)		Max. 5ms	Max. 10ms
Mechanical characteristics	Vibration	Mechanical	1.5mm amplitude at frequency of 10 to 55 Hz (for 1 min) in each X, Y, Z direction for 1 hour	
		Malfunction	1.5mm amplitude at frequency of 10 to 55 Hz (for 1 min) in each X, Y, Z direction for 10 minute	
	Shock	Mechanical	1,000m/s ² (approx. 100G) in each X, Y, Z direction for 3 times	
		Malfunction	100m/s ² (approx. 10G) in each X, Y, Z direction for 3 times	
Life expectancy	Mechanical	Min. 20,000,000 operations (at 18,000 operations/hour)	Min. 10,000,000 operations (at 18,000 operations/hour)	
	Electrical	Min. 100,000 operations (at 1,800 operations/hour)		
Environment	Ambient temperature	-40 to 70°C		
	Ambient humidity	5 to 85%RH		
Weight	Approx. 20g			

※Environment resistance is rated at no freezing or condensation.

■ Dimensions

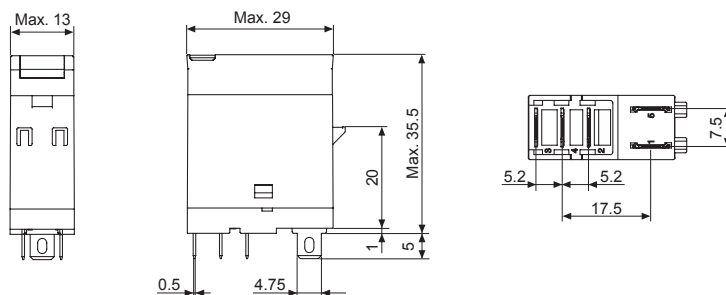

- Circuit diagram (bottom view)

(unit: mm)

- G2R-1-S

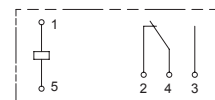

- G2R-1-SD (DC)

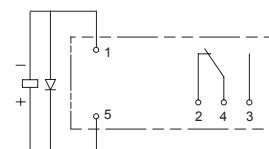

OMRON Power Relay 1 Form A

■ Features

- Slim type
- High capacity, high reliability

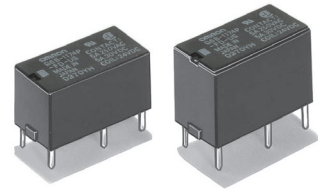

■ Coil Specifications

Model	Rated voltage	Must operate voltage	Must release voltage	Rated current	Coil resistance	Power consumption
G6B-1174P-FD-US	24VDC	Min. 70% of rated voltage	Max. 10% of rated voltage	8.3mA	2,880Ω	200mW

■ Contact Specifications

Manufacture		OMRON			
Model		G6B-1174P-FD-US			
Contact	Arrangement	1 Form A (SPST-1a)			
	Material	AgCdO type			
	Resistance (initial)	30mΩ (5VDC 1A)			
Rating	Rated load (resistive load)	5A 250VAC	5V 30VDC		
	Max. switching power	1,250VA	150W		
	Max. switching voltage	380VAC	125VDC		
	Max. switching current	5A			
Electrical characteristics	Insulation resistance (initial)	Min. 1,000MΩ (at 500VDC megger)			
	Dielectric strength	Between contact-coil	3,000VAC 50/60Hz for 1 minute		
		Between open contacts	1,000VAC 50/60Hz for 1 minute		
	Surge voltage	6,000V			
	Operate time (supplying rated voltage)	Max. 20ms			
	Release time (supplying rated voltage)	Max. 5ms			
Mechanical characteristics	Vibration	Mechanical	3.5mm amplitude at frequency of 10 to 55 Hz (for 1 min) in each X, Y, Z direction for 1 hour		
		Malfunction	2.5mm amplitude at frequency of 10 to 55 Hz (for 1 min) in each X, Y, Z direction for 10 minute		
	Shock	Mechanical	1,000m/s ² (approx. 100G) in each X, Y, Z direction for 3 times		
		Malfunction	100m/s ² (approx. 10G) in each X, Y, Z direction for 3 times		
Life expectancy	Mechanical	Min. 50,000,000 operations (at 300 operations/min)			
	Electrical	Min. 100,000 operations (5A, 250VAC, 30VDC) (at 30 operations/min)			
Environment	Ambient temperature	-25 to 70°C			
	Ambient humidity	5 to 85%RH			
Weight	Approx. 5g				

※Environment resistance is rated at no freezing or condensation.

■ Dimensions

(unit: mm)

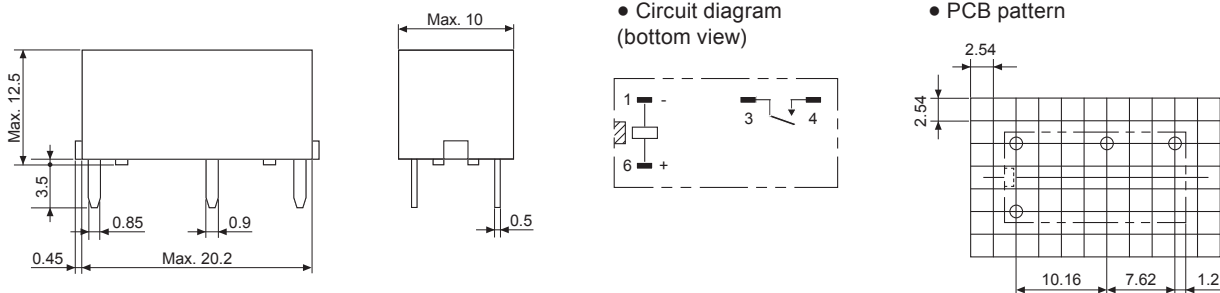

I/O Terminal Blocks

AFS(Interface Terminal Block)
 AFL/AFR(Interface Terminal Block)
 ACS(Common Terminal Block)
 AFE(Sensor Connector Terminal Block)
 ABS(Relay Terminal Block)
 ABL(Relay Terminal Block)

Power Relay

I/O Cables

MITSUBISHI
 LSIS
 Autonics
 RS Automation
 YOKOGAWA
 FUJI
 KDT
 OMRON
 TELEMECANIQUE
 For SERVO
 Open Type Cables
 Cable Appearance

Remote I/O

ARD(DeviceNet Digital Standard Terminal Type)
 ARD(DeviceNet Digital Sensor Connector Type)
 ARD(DeviceNet Analog Standard Terminal Type)
 ARM(Modbus Digital Sensor Connector Type)

Others

Sensor Connectors
 Sockets
 Sensor Distribution Boxes
 Valve Plugs
 Thumbwheel Switches