

BTF Series Ultra-slim And Amplifier Built-in Type

Ultra-slim And Amplifier Built-in Type

■ Features

- Realization of ultra-slim size by adopting one-chip photo IC
- Size: Through-beam (W13×H19×L3.7mm),
Diffuse reflective, BGS reflective (W13×H24×L3.7mm)
- Adopts BGS method superior than convergent reflective to minimize error by background color, or material of sensing object for stable sensing
- Visible light source to check the position of sensing spot and superior to small sensing target with narrow sensing width
- Built-in reverse polarity, output short, overcurrent protection circuit
- Protection structure IP67 (IEC standard)

⚠ Please read "Caution for your safety" in operation manual before using.

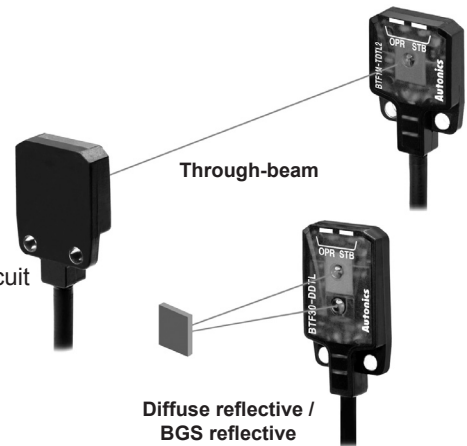

■ Specifications

Model	NPN open collector output		PNP open collector output			
	BTF1M-TDTL	BTF1M-TDTD	BTF30-DDTL	BTF30-DDTD	BTF15-BDTL	BTF15-BDTD
	BTF1M-TDTL-P	BTF1M-TDTD-P	BTF30-DDTL-P	BTF30-DDTD-P	BTF15-BDTL-P	BTF15-BDTD-P
Sensing type	Through-beam		Diffuse reflective		BGS reflective	
Sensing distance	1m		5 to 30mm (Non-glossy white paper 50×50mm)		1 to 15mm (Non-glossy white paper 50×50mm)	
Sensing target	Opaque materials of max. Ø2mm		Opaque materials, Translucent materials			
Min. sensing target	Opaque materials of Ø2mm		Ø0.2mm (Sensing distance 10mm)		Ø0.2mm non-illuminated objects (Sensing distance 10mm)	
Hysteresis	—		Max. 20% at rated sensing distance		Max. 5% at rated sensing distance	
Reflectivity characteristics (black/white error)	—		—		Max. 15% of maximum sensing distance	
Response time	Max. 1ms					
Power supply	12-24VDC ±10% (Ripple P-P: Max. 10%)					
Current consumption	Max. 20mA (This is for each emitter and receiver of through-beam type)					
Light source	Red LED (650nm)					
Operation mode	Light ON	Dark ON	Light ON	Dark ON	Light ON	Dark ON
Control output	NPN or PNP open collector output ●Load voltage: Max. 26.4VDC ●Load current: Max. 50mA ●Residual voltage - NPN:Max. 1V, PNP:Max. 2V					
Protection circuit	Reverse polarity protection, output short-circuit protection					
Indicator	Operation indicator: Red, Stability indicator: Green					
Insulation resistance	Min. 20MΩ (at 500VDC megger)					
Noise resistance	±240V the square wave noise (pulse width: 1μs) by the noise simulator					
Dielectric strength	1,000VAC 50/60Hz for 1 minute					
Vibration	1.5mm amplitude at frequency of 10 to 55Hz (for 1 min.) in each X, Y, Z direction for 2 hours					
Shock	500m/s ² (approx. 50G) in each X, Y, Z direction for 3 times					
Environment	Ambient illumination	Sunlight: Max. 10,000lx Incandescent lamp: Max. 3,000lx (Receiver illumination)				
	Ambient temperature	-25 to 55°C, storage: -40 to 70°C				
	Ambient humidity	35 to 85%RH, storage: 35 to 85%RH				
Protection structure	IP67 (IEC standards)					
Material	Case: PBT, Sensing part: PMMA					
Cable	Ø2.5mm, 3-wire, Length: 2m (emitter of through-beam type: Ø2.5, 2-wire, Length: 2m) (AWG28, Core diameter: 0.08mm, Number of cores: 19, Insulator out diameter: Ø0.9mm)					
Accessory	Fixing bracket (SUS304), Bolt (SWCH10A)					
Approval	CE					
Unit weight	Approx. 40g		Approx. 25g			

※The temperature or humidity mentioned in Environment indicates a non freezing or condensation environment.

(A) Photoelectric Sensors

(B) Fiber Optic Sensors

(C) Door/Area Sensors

(D) Proximity Sensors

(E) Pressure Sensors

(F) Rotary Encoders

(G) Connectors/ Sockets

(H) Temperature Controllers

(I) SSRs / Power Controllers

(J) Counters

(K) Timers

(L) Panel Meters

(M) Tacho / Speed / Pulse Meters

(N) Display Units

(O) Sensor Controllers

(P) Switching Mode Power Supplies

(Q) Stepper Motors & Drivers & Controllers

(R) Graphic/ Logic Panels

(S) Field Network Devices

(T) Software

BTF Series

■ Feature Data

◎ Through-beam

● BTF1M-TDTL / BTF1M-TDTL-P

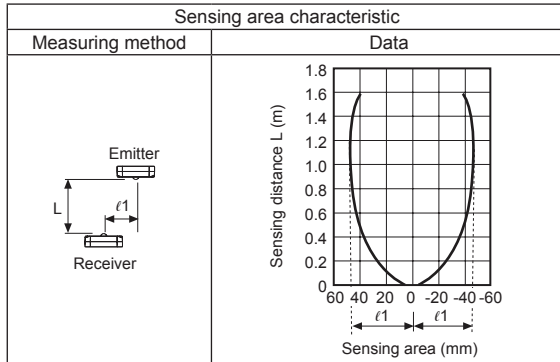

◎ Diffuse reflective

● BTF30-DDTL / BTF30-DDTL-P

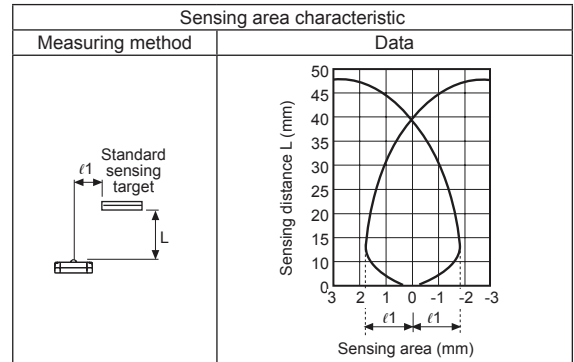

◎ BGS reflective

● BTF15-BDTL / BTF15-BDTL-P

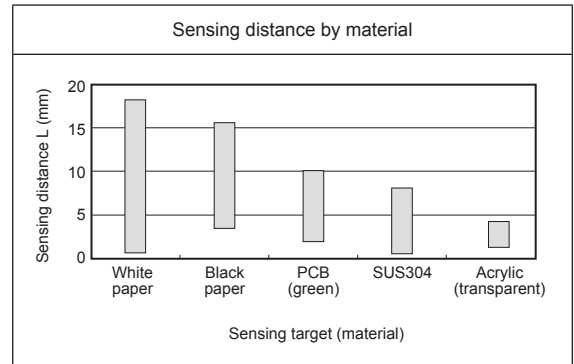
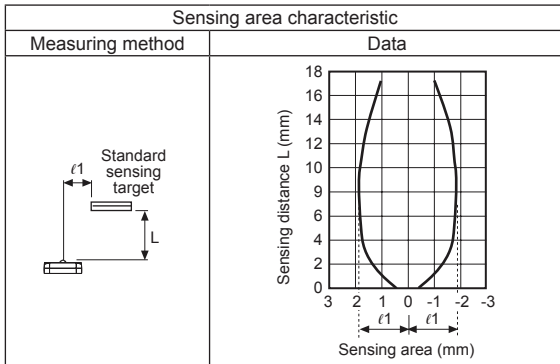

■ Connections

● Through-beam

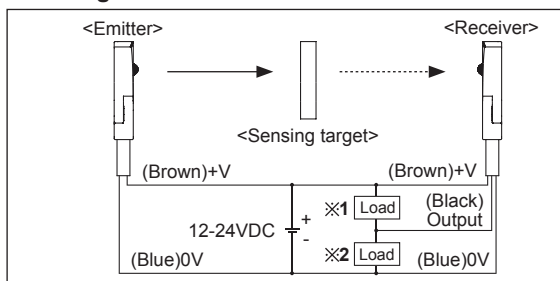

● Diffuse reflective/BGS reflective

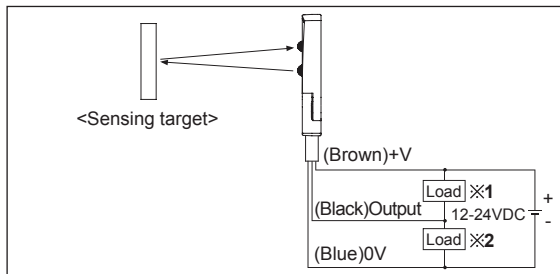

※1: Load connection for NPN output

※2: Load connection for PNP output

■ Control Output Diagram

● NPN open collector output

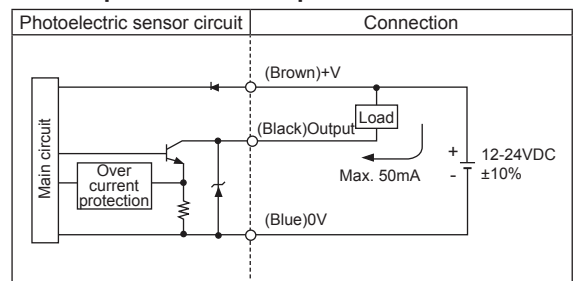

● PNP open collector output

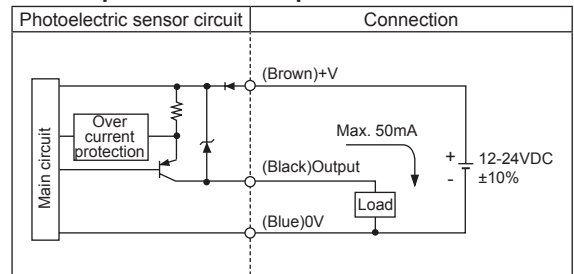

Ultra-slim And Amplifier Built-in Type

■ Operation Mode

Operation mode	Light ON	Dark ON
Receiver operation	Received light Interrupted light	Received light Interrupted light
Operation indicator (red LED)	ON OFF	ON OFF
Transistor output	ON OFF	ON OFF

■ Dimensions

(unit: mm)

● Through-beam

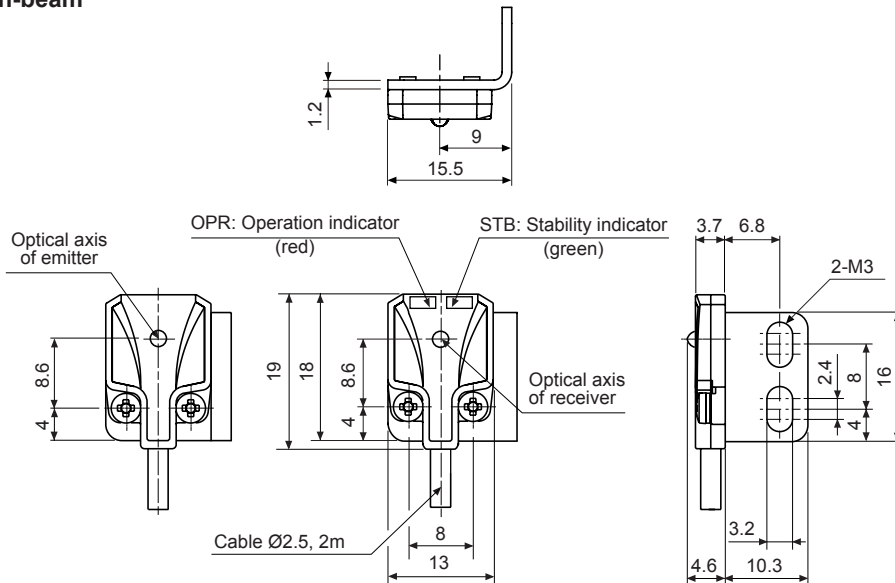

● Diffuse reflective/BGS reflective

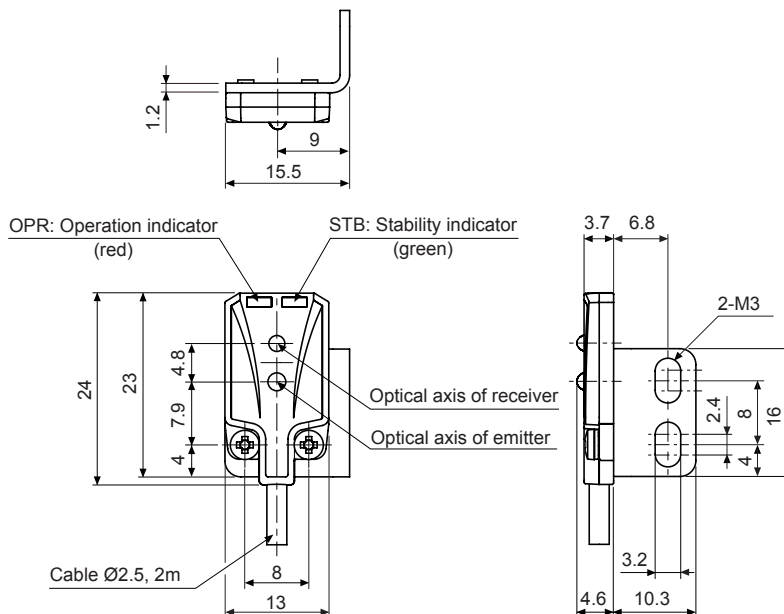

(A) Photoelectric Sensors

(B) Fiber Optic Sensors

(C) Door/Area Sensors

(D) Proximity Sensors

(E) Pressure Sensors

(F) Rotary Encoders

(G) Connectors/ Sockets

(H) Temperature Controllers

(I) SSRs / Power Controllers

(J) Counters

(K) Timers

(L) Panel Meters

(M) Tacho / Speed / Pulse Meters

(N) Display Units

(O) Sensor Controllers

(P) Switching Mode Power Supplies

(Q) Stepper Motors & Drivers & Controllers

(R) Graphic/ Logic Panels

(S) Field Network Devices

(T) Software

BTF Series

■ Operation Timing Diagram

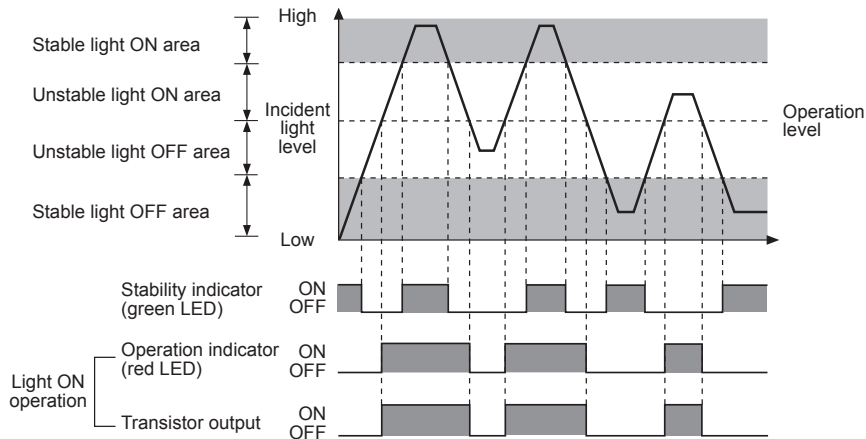

※The waveforms of “Operation indicator” and “Transistor output” are for Light ON operation. They are opposite operation for Dark ON operation.

■ Mounting And Sensitivity Adjustment

◎ For mounting

Please use bolts M2 for mounting this sensor and the tightening torque is under 0.3 N·m.

※Do not impact on the unit with hard objects and do not bend the cable part too much. It may cause damage to waterproof function.

● Through-beam

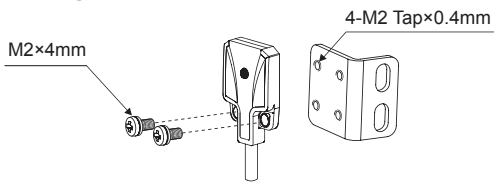

● Diffuse reflective/BGS reflective

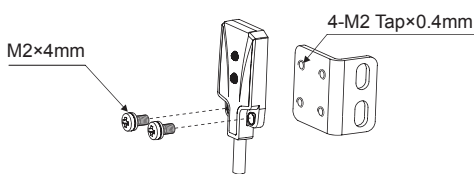

※ Notice for BGS reflective type

1) Make sure that the sensing side of this sensor is parallel with the surface of each sensing object.

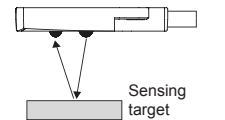

2) If the sensing object has glossy surface or high reflection, the sensor tilts from 5 to 10° as shown in the figure.

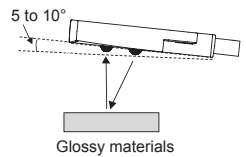

Make sure whether the sensor is influenced by any background objects.

3) Make sure to install the sensor in the proper direction with considering moving direction of sensing objects. Refer to the following.

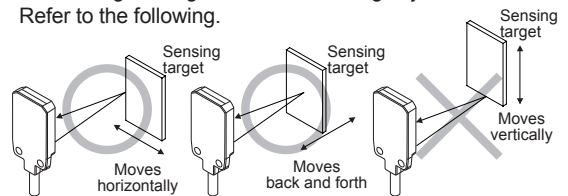

◎ Optical axis adjustment

● Through-beam

Set the emitter and the receiver facing each other and adjust these up-down, right-left after checking the point of operating the stability indicator. Fix the emitter and the receiver at the center of the point.

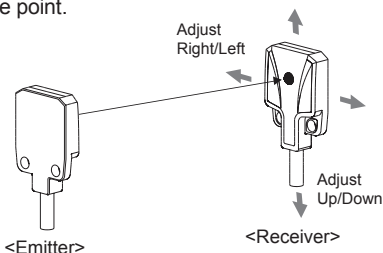

● Diffuse reflective/BGS reflective

After placing a sensing target, fix it in the middle of position where the stability indicator operates when adjusting the sensor to up-down, right-left. Make sure that the sensing side of the sensor is parallel with the surface of each sensing target.

