XINJE

XP/XMP-18 series
Integral industrial controller
Operating manual

WUXI XINJE ELECTRIC CO., LTD.

Data No. PHC01 20140730 3.0



XP/XMP-18

Series

Operating manual

Catalog

Preface

Safety Notes

Summarization 1

Input/output specification and 2

exterior layout 3

PLC Function and Application 4

HMI Function and Application 5

Extension Ability

V1.0

This manual includes some basic precautions which you should follow to keep you safe and protect the products. These precautions are underlined with warning triangles in the manual. About other manuals that we do not mention, please follow basic electric operating rules.

Precautions



Please follow the precautions. If not, it may lead the control system incorrect or abnormal, even cause fortune lose.

Correct Application



The models could only be used according to the manual, and an only be used along with the peripheral equipments recognized or recommended by XINJE. They could only work normally in the condition of be transported, kept and installed correctly, also please operate and maintain them according to the recommendation.

WUXI XINJE ELECTRIC CO., LTD. Copyright reserved

Without exact paper file allowance, copy, translate or using the manual is not allowed. Disobey this, people should take the responsibility of loss. We reserve all the right of expansions and their design patent.

Duty Declare

We have checked the manual, its content fits the hardware and software of the products. As mistakes are unavoidable, we couldn't promise all correct. However, we would check the data in the manual frequently, and in the next edition, we will correct the necessary information. Your recommendation would be highly appreciated

Catalog

SAFETY NOTICE.....	6
1. SUMMARIZATION.....	7
1-1. Product summarization.....	7
1-2. Specs.....	9
1-3. Parts explanation.....	11
1-4. Outline dimension.....	13
2. IN-OUT SPECS AND EXTERIOR LAYOUT.....	15
2-1. Input specs.....	15
2-2. Relay output specs and circuit.....	17
2-3. Transistor output specs and circuit.....	19
3. PLC FUNCTION AND APPLICATION.....	21
3-1. PLC instruction.....	21
3-2. soft component range.....	22
3-3. Set up a project.....	26
3-4. communication function.....	29
4. HMI FUNCTION AND APPLICATION.....	33
4-1. HMI function introduction.....	33
4-2. Build a project.....	34
5. THE EXTENSION ABILITY OF XP/XMP.....	37
5-1. extend BD board.....	37
5-2. extend MA model.....	40
5-3. Other extension.....	43

Preface

Thank you for purchasing XINJE XP/XMP series integral industrial controller, please read the manual before operating.

Manual purpose

- This manual provides user with the guide of using and operating our product, it includes the product characteristics, spec explanation, using method, etc.
- This manual contains product summarization, exterior layout, PLC program, and exterior extension.
 - Summarization: introduce the product characteristics, specs, dimension, installation.
 - Exterior layout: introduce the product power spec, in-out layout.
 - PLC program: introduce how to program in PLC.
 - HMI picture: introduce how to edit picture in OP.
 - Exterior extension: introduce extension ability of the product.

Suitable people

This manual aims to below users:

- Terminal user
- Debugging person
- Technology support person

Make sure you have read the safety notice before operating.

Scope

This manual applies to the XP/XMP series integral industrial controller.

Tele-document

XINJE provides user with press document and CD:

- User CD
Contained software, manual and application examples
- XINJE website
Welcome to www.xinje.com download center to find electronic document.

Contact us

If you have any questions, please contact us.

Tel: 86-0510-85134136

Fax: 86-0510-85111290

Safety notice

Read the manual carefully before operating. Be aware of the safety and correct operation. The content below is focus on XP/XMP series products only.

Please safekeeping the manual, put in somewhere easy to get and read and give the manual to final user.

⊙ Notice items ⊙



ATTENTION

- Do not put the wire close to cable, keep 10cm distance at least.
- Do not change the inside module of product or it may cause fault, error action, loss, fire.
- When it smelly or noisy, cut the power immediately (short tweet after power on is normal).
- Do not press the screen with pen, screwdriver or other sharp tools, it may cause screen break or error.
- For installing the product, tighten the screws to avoid losing.
- Transport, install, store, assemble and maintain the product accurately to avoid breaking.



DANGEROUSNESS

- Confirm the power voltage and wire connection before turn on the power in order to avoid breaking
- Do not touch the connection point to avoid getting an electric shock
- Do not open the back cover board
- Cut all the power before installation and take-down to avoid error and fault
- Please use in the surrounding the manual stated to avoid accident
- Do not use the product under the condition of high frequency radiation, strong

magnetic field to avoid interference

1. Summarization

1-1. Product summarization

XP/XMP-18 series integral industrial controller integrated human machine interface (HMI) and PLC (XC1, XC2, XC3 series). It can instead of HMI and PLC to fulfill the control function. It can save space with slim outline and improve the convenience of maintenance.

Product characteristics

- ◆ Integrate logical control, analog quantity in-out and HMI into the product
 - On-off quantity input: 10 points, optical coupling insulation
 - On-off quantity output: 8 points, relay output/transistor output/R&T mixture output
 - Analog quantity: XP/XMP can extend BD board to realize analog quantity in-out control
 - Easy edit of the HMI picture, rich function
- ◆ LCD display: 192×64 pixel (3.7 inch), LCD useful life can reach 0.5 million hours
- ◆ 26 function keys can be redefined by user
- ◆ Sensitive and accurate key-press
- ◆ Multifunctional download port: HMI and PLC use one download cable
- ◆ Waterproof level is IP20
- ◆ Small structure, space saving
- ◆ Simple and modern outline

Type List

XMP series		
Relay output	Transistor output	Relay&Transistor output
XMP1-18R	XMP1-18T	XMP1-18RT
XMP2-18R	XMP2-18T	XMP2-18RT
XMP3-18R	XMP3-18T	XMP3-18RT

XP series		
Relay output	Transistor output	Relay&Transistor output
XP1-18R	XP1-18T	XP1-18RT
XP2-18R	XP2-18T	XP2-18RT
XP3-18R	XP3-18T	XP3-18RT

Type Name

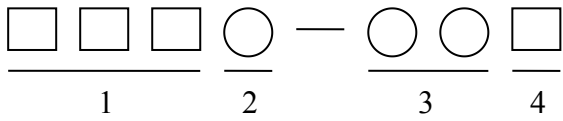

- | | |
|------------------|--|
| 1: Name | XP, XMP series |
| 2: PLC Type | 1: XC1 series
2: XC2 series
3: XC3 series |
| 3: In-out points | 18: Input 10 points, output 8 points |
| 4: Output Type | R: Relay output
T: Transistor output
RT: Relay&Transistor output |

Notice: XMP series exclude XMP2-32 series products in this manual. About these products, please refer to Integral Controller Manual XMP2-32.

1-2. Specs

General Specs

Item		Specs
Electric	Power supply voltage	DC12V~DC24V
	Power	Less than 10W (TYP2.0W)
	Power cut moment permit	Less than 20ms
	Endurable voltage	AC1000V/10MA for 1minute (between signal and ground)
	Insulated impedance	About 10MΩ , DC500V (between signal and ground)
Surrounding	Operating temperature	0~50℃
	Storage temperature	-10~60℃
	Environment temperature	20~85% (No dew)
	Endurable quiver	10~25Hz (X, Y, Z direction for 30 minutes)
	Anti-jamming	Voltage Noise: 1000Vp-p
	Air	No causticity gas
	Protection	According to IP20
Configuration	Cooling mode	Natural wind
	Dimension	172.0*121.0*56.5
	Panel open aperture dimension	164.0*113.0
Port	Download port	RS-232
	Com port	RS-485

HMI Specs

Item		Specs	
		XP series	XMP series
Characteristic	Type	Kelly/Blue LCD	
	Screen dimension	3.7 inch	
	Useful life	Over 20000 hours, 25°C, 24hours operating	
	Display area	192*64	
	Contrast	Regulation resistance available	
	Character setting	Chinese, English	
	Character size	Lattice font, vector font	
	Touch mode	Touch unable	Matrix or resistance touch mode
Register	Picture	64KB Flash ROM	
	Data	4KB SRAM	

PLC Specs

Item		Specs		
		XP1/XMP1	XP2/XMP2	XP3/XMP3
Program executing format		Loop scan format, time scan format		
Program format		Instruction, C language and ladder chart		
Processing speed		0.5us		
Power cut retaining		Use Flash ROM and Li battery		
User program's capacity		32KB	128KB	128KB
I/O points		Input 10 points, output 8 points		
Interior coil's points (M)		448	8768	8768
Timer (T)	Points	80	640	640
	Specs	100mS timer: Set time 0.1~3276.7 seconds 10mS timer: Set time 0.01~327.67 seconds 1mS timer: Set time 0.001~32.767 seconds		
Counter (C)	Points	48	640	640
	Specs	16 bits counter: set value K0~32767 32 bits counter: set value -2147483648~2147483647		
Data Register (D)		288 words	2612 words	9024 words

Flash ROM Register (FD)	510 words	512 words	2048 words
Extension D register (ED)	-	-	16383
High speed processing function	-	High speed count, pulse output, external interrupt	
Setting of time scan space	0~99mS		
Password protection	6 bits ASCII		
Self diagnose function	Power on self-diagnose, Monitor timer, grammar check		

Note: The user program capacity is referred to the capacity under “secret downloading mode”.

1-3. Parts explanation

Configuration

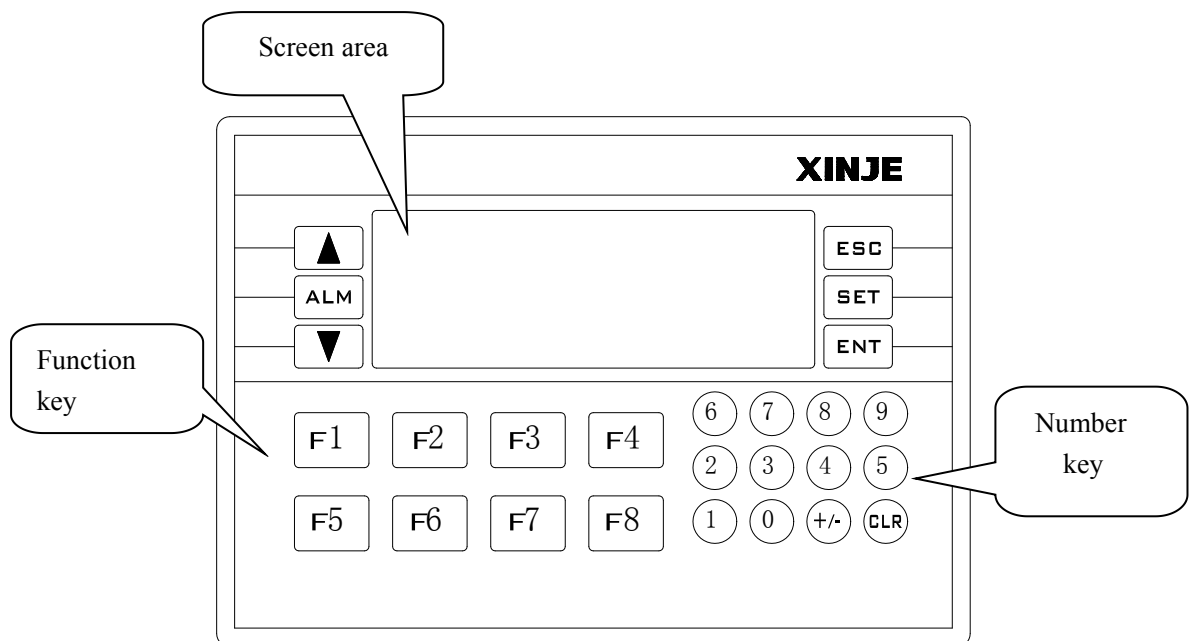

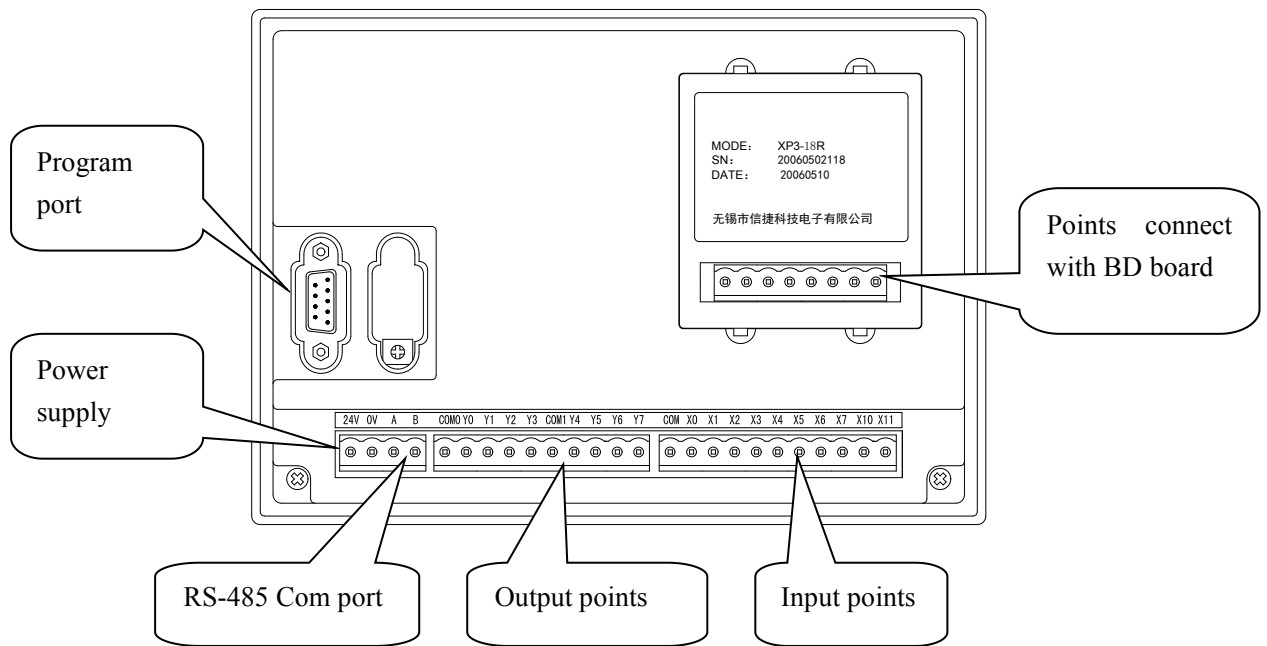

In-out points arrangement

24V 0V A B COM0 Y0 Y1 Y2 Y3 COM1 Y4 Y5 Y6 Y7 COM X0 X1 X2 X3 X4 X5 X6 X7 X10 X11

- 24V, 0V: power supply input
- A, B: RS-485 com port
- COM: common ground
- X: Input
- Y: Output

Program port

Program port is a RS-232 com port which has double functions of downloading PLC program and HMI pictures. The pins function of the port is as below:

Pin	Function
Pin2	RXD
Pin3	TXD
Pin5	GND
Pin7	RTS

Xinje provides special program cable to download the PLC program or HMI program. You also can make the cable by yourself. Please see the pin connection between PC and the port.

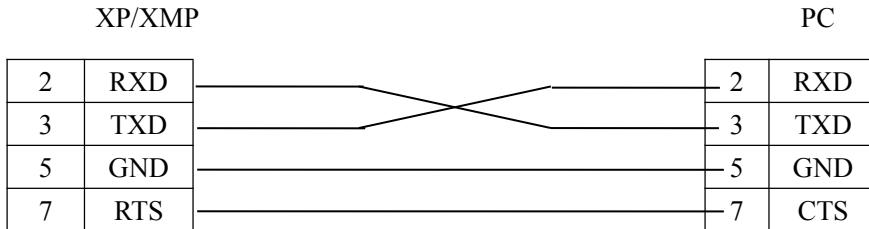
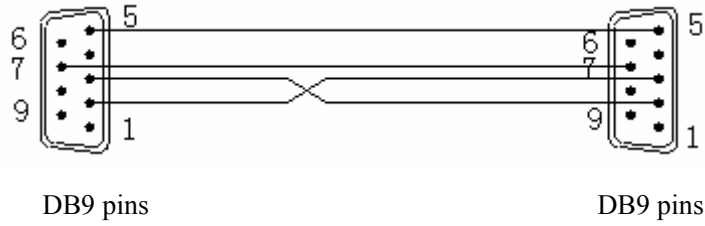

Communication port

Communication port (A and B) is a RS-485 com port. This port is used to connect other devices. Please refer to paragraph 3-4 for details.

1-4. Outline dimension

Outline dimension

Unit: mm

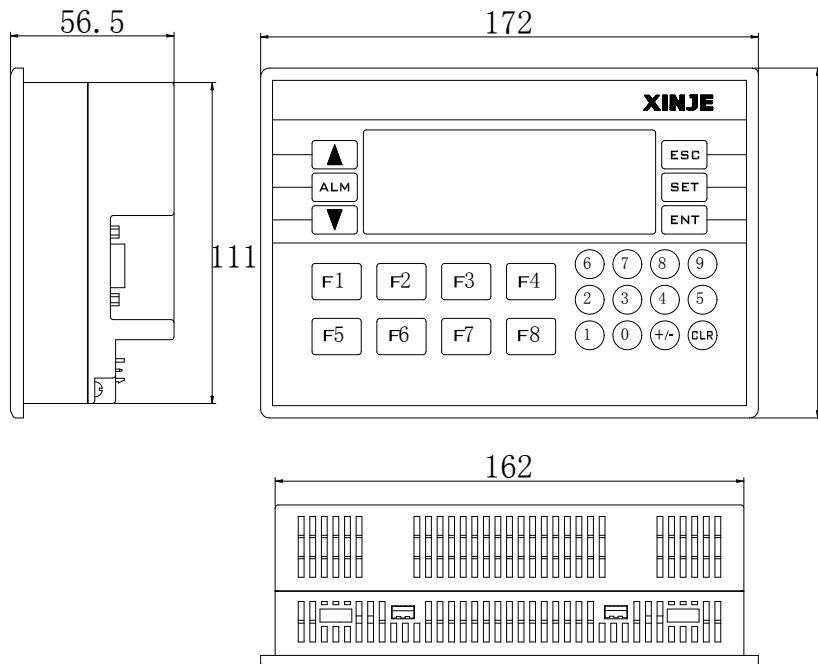

Installation dimension

Unit: mm

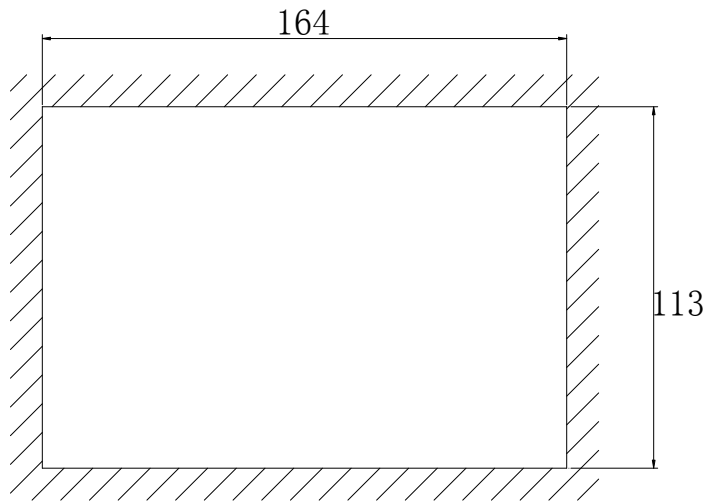

2. In-out specs and exterior layout

2-1. Input specs

Basic unit

Input signal's voltage	DC24V±10%
Input signal's current	7mA/DC24V
Input ON current	Above 4.5mA
Input OFF current	Below 1.5mA
Input response time	About 10ms
Input signal's format	Contact input or NPN open collector transistor
Circuit insulation	Photo-electricity coupling insulation
Input action's display	LED light when input ON

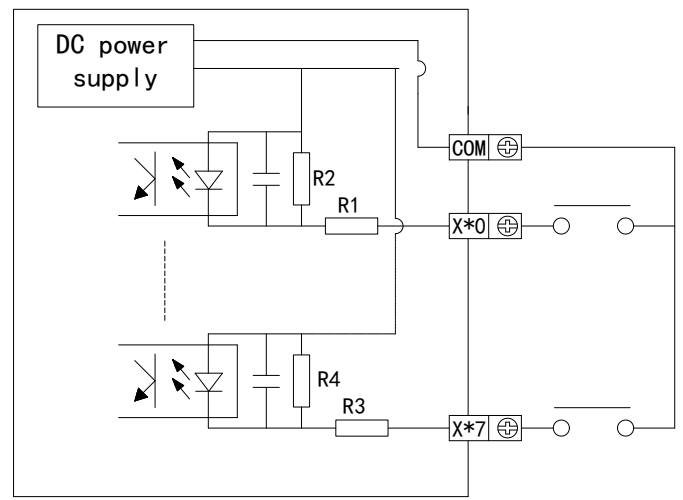

Input connection

Because there is no 24V power supply inside XP/XMP, it needs an outside supplier to drive the photo-electricity switch sensor. The supplier should be DC 24V±4V. The output transistor of sensor should be NPN open collector.

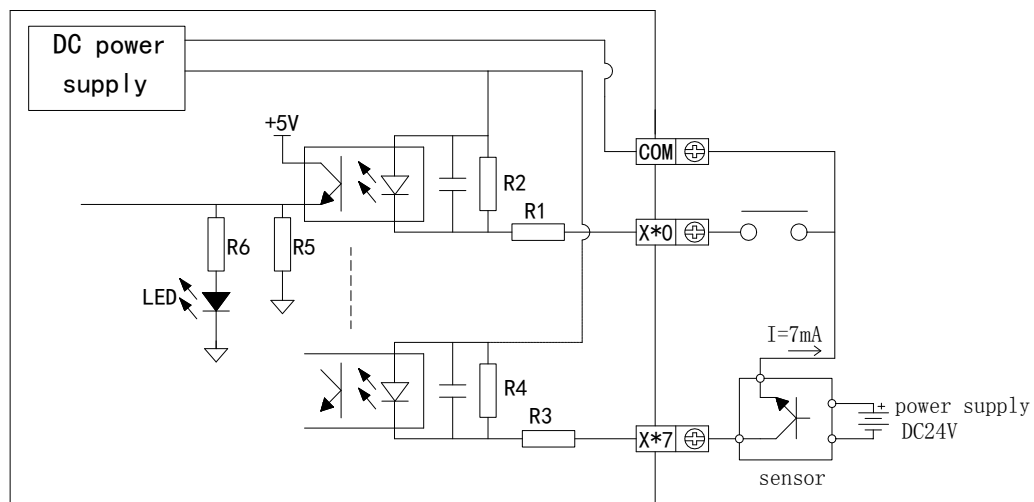

- **Input points**
Connect input point and com point with non-voltage point or NPN open collector transistor to turn on the input.
- **Input loop**
The first loop and the second loop are insulated by optical coupler, the second loop has C-R filter which can prevent wrong action caused by industry noise or input points oscillation. As the result, there will be a response delay for 10ms to the input points. There is digital filter in the input points.
- **Input sensitivity**
Input current is DC 24V 7mA. To make the input reliable, the ON current should be above 3.5mA, the OFF current should be below 1.5mA.

Typical connection

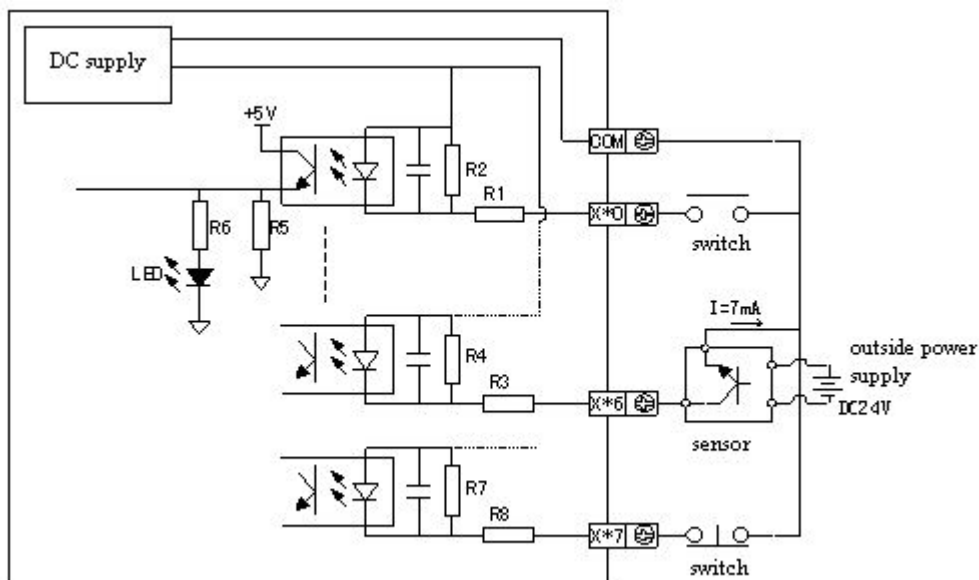

2-2. Relay output specs and circuit

Relay output specs

Type		R /RT output	T output
Relay output		R: Y0~Y7 RT: Y4~Y7	NO
Power supply		Below AC250V、DC30V	
Circuit insulation		Machinery insulation	
Action indication		Produce close sound	
Maximum load	Resistor load	3A	
	Inductance load	80VA	
	LED load	100W	
Minimum load		DC5V 2mA	
Response time	OFF→ON	10ms	
	ON→OFF	10ms	

Relay output circuit

- Output points
Relay output has two common points. Different units can drive the loader of different power-voltage systems.
- Loop insulation
It is electric insulated between relay output point and outside load circuit.
- Action indication
Relay output coil produces close sound when it is on.
- Response time
The response time is about 10ms transferring the ON or OFF signal from relay output coil to the output connection.
- Output current
Output current is 3A per point to drive resistance load for voltage below AC250V.
Inductance load is below 80VA (AC100V or AC200V) and lamp load is below 100W (AC100V or AC200V).
- Open leakage current
There is no leakage current when output point is OFF, it can drive neon light.
- Use life of relay output point
The standard life of inductance load such as contactor, solenoid valve: according to our experiment results, 20VA load is about 3 million times, 35VA load is about 1 million times, 80VA load is about 0.2 million times. However, the life will extend if parallel connect surge

absorber with the load.

Output connection example

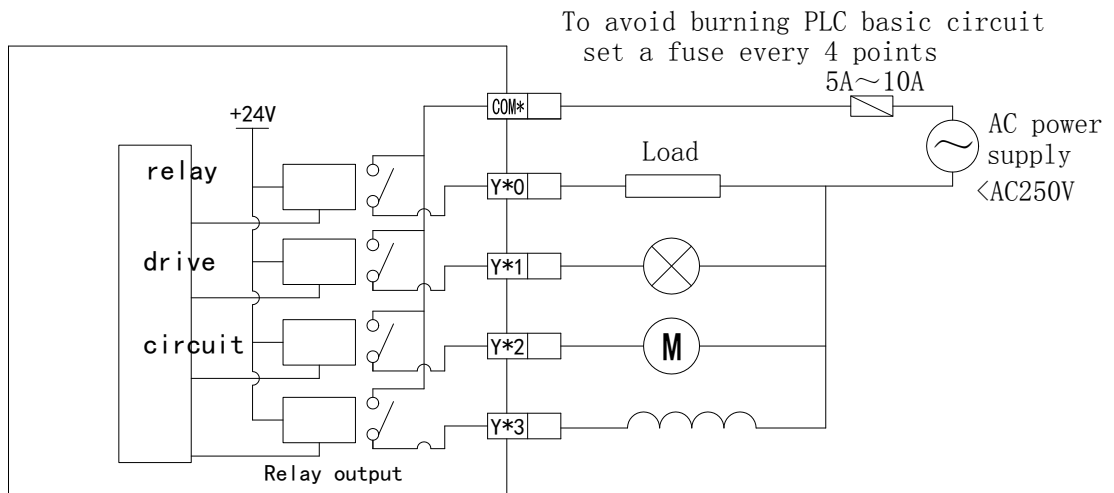

Note: T type has no relay output, do not connect AC220V, or the product will be broken.

Constitution of output circuit

- For DC inductor load, please parallel connect with commutate diode. If not connect with the commutate diode, the point's life will be decreased greatly. Please choose the commutate diode which allow inverse voltage endurance up to 5~10 times of the load's voltage, ordinal current exceeds load current.
- Parallel connect AC inductor load with surge absorber can reduce noise and extend useful life of the points.

DC load

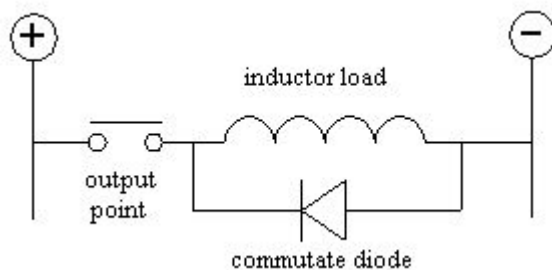

AC load

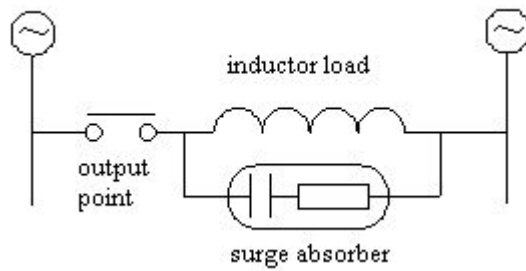

2-3. Transistor output specs and circuit

Transistor output can divide into two types: high speed pulse output and normal transistor output.

High speed pulse output

Type	RT output	T output
High speed pulse output point	Y0~Y1	Y0~Y1
Power supply	Below DC5~30V	
Maximum current	50mA	
Maximum pulse frequency	200KHZ	

Normal transistor output

Type	RT output	T output
Transistor output point	Y2~Y3	Y2~Y7
Power supply	Below DC5~30V	
Circuit insulation	Optical coupling insulation	
Maximum load	Resistor load	0.4A
	Inductor load	12W/DC24V
	Light load	1.5W/DC24V
Minimum load	DC5V 2mA	
Repose time	OFF→ON	Below 0.2ms
	ON→OFF	Below 0.2ms

Normal transistor output circuit

- Output point

There is one common point for basic unit transistor output

- Power supply
The load circuit power supply should be steady voltage of DC5~30V.
- Circuit insulation
The inside circuit of XP/XMP is insulated with output transistor by optical coupler.
- Action indication
When driving optical coupling, LED lights, output transistor is ON.
- Response time
From optical coupler driving (or cut) to transistor ON (or OFF), the time is below 0.2ms.
- Output current
The current is 0.4A per point. But due to restriction of temperature going up, the total current is 0.8A every four points.
- Open current
Less than 0.1mA.

To avoid burning PLC basic circuit
use suitable fuse for the load

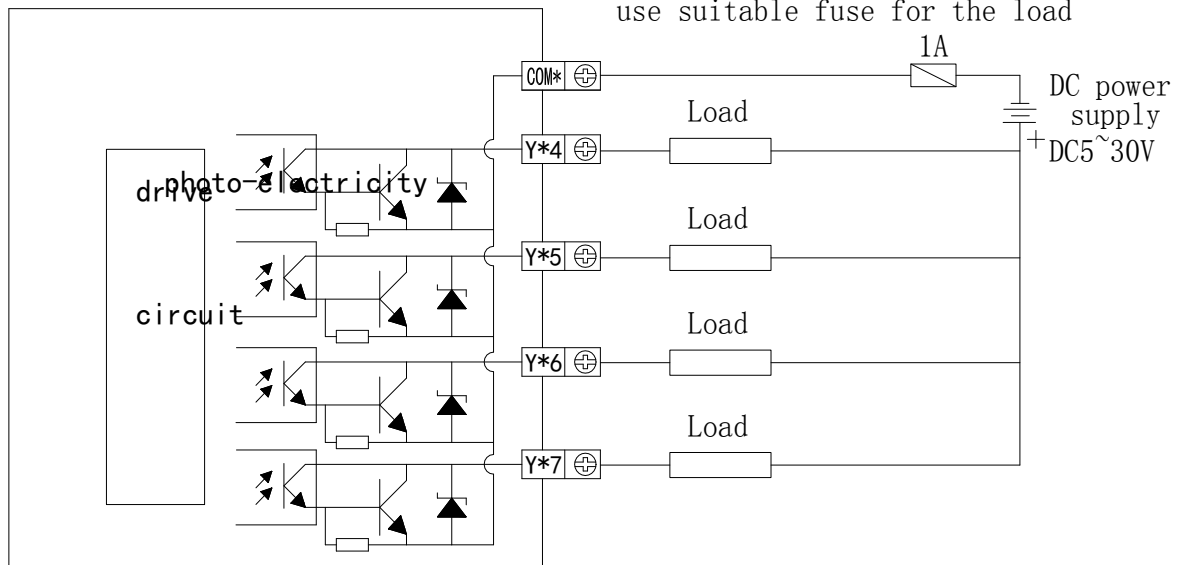

3. PLC function and application

3-1. PLC instruction

The XP/XMP integrated with XC series PLC. The function of PLC is the same as XC series.

XP/XMP Type	Integrated PLC type
XP1/XMP1 series	XC1 series
XP2/XMP2 series	XC2 series
XP3/XMP3 series	XC3 series

Instruction

1. XP1/XMP1 series include SFC instructions and applied instructions, exclude special function instructions.
2. XP2/XMP2 series and XP3/XMP3 series have the same instructions. They include SFC instructions, applied instructions and special function instructions.

Please refer to XC Series PLC Manual: paragraph 4, 5, 6.

Special function instructions

XP2/XMP2 and XP3/XMP3 have special function instructions, please refer to XC Series PLC Operating Manual: paragraph 6. Here we only give the port definition and distribution.

1. High speed count

XP2/XMP2/XP3/XMP3 series																		
	Increase mode										Pulse+direction mode					AB phase mode		
	C600	C602	C604	C606	C608	C610	C612	C614	C616	C618	C620	C622	C624	C626	C628	C630	C632	C634
Highest frequency	80K	80K	10K	10K	10K						80K	10K	10K			80K	5K	
4 times frequency																√		
Count interruption	√	√	√	√	√						√					√		
X000	U										U					A		
X001		U									Dir					B		
X002																		
X003			U									U					A	
X004												Dir					B	
X005																		
X006				U									U					
X007													Dir					

X010																		
X011					U													
X012																		

2. High speed pulse output

- ◆ T type: Y0, Y1 available, the highest frequency is 200KHz
- ◆ RT type: Y0, Y1 available, the highest frequency is 200KHz
- ◆ R type: unavailable

3. Interrupt function

Channel	Input	Pointer tag		Disable interruption instruction
		Rising interruption	Falling interruption	
CHL1	X2	I0000	I0001	M8050
CHL2	X5	I0100	I0101	M8051
CHL3	X10	I0200	I0201	M8052

4. Frequency measurement

The point is X1, X11, X12.

5. Pulse width modulation

The point is Y0, Y1.

- ◆ T type: Y0, Y1 available
- ◆ RT type: Y0, Y1 available
- ◆ R type: unavailable

6. Precise timer

32 bit precise timer, the timer range is T600 to T618, match with 10 interruption tag.

3-2. soft component range

XP/XMP series soft component ID distribution list is as below:

If extending BD board, the in-out point definition, please refer to XP Series Extended BD Board Manual.

XP1/XMP1 series:

Soft component	Name	Range	Points
X	Input points	X000~X011(octal)	10
Y	Output points	Y000~Y007(octal)	8
M	Auxiliary relay	M0~ M199 【M200~M319】	320
		For special using M8000~M8079	128
		For special using M8120~M8139	
		For special using M8170~M8172	
		For special using M8238~M8242	
		For special using M8350~ M8370	
S	Process	S0~S31	32
T	Timer	T0~T23: 100ms not accumulation	80
		T100~T115: 100ms accumulation	
		T200~T223: 10ms not accumulation	
		T300~T307: 10ms accumulation	
		T400~T403: 1ms not accumulation	
		T500~T503: 1ms accumulation	
C	Counter	C0~C23: 16 bits plus counter	48
		C300~C315: 32bits plus/minus counter	
		【C600~C603】 : vacant	
		【C620~C621】 : vacant	
		【C630~C631】 : vacant	
D	Data register	D0 ~D99 【D100~D149】	150
		For special using D8000~D8029	138
		For special using D8060~D8079	
		For special using D8120~D8179	
		For special using D8240~D8249	
		For special using D8306~D8313	
		For special using D8460~D8469	
FD	Flash ROM register	FD0~FD411	412
		For special using FD8000~FD8011	98
		For special using FD8202~FD8229	
		For special using FD8306~FD8315	
		For special using FD8323~FD8335	
		For special using FD8350~ FD 8384	

XP2/XMP2 and XP3/XMP3 series:

Soft component	Name	Range		Point	
		XP2/XMP2	XP3/XMP3	XP2/XMP2	XP3/XMP3
X	Input point	X000~X011(octal)		10	
Y	Output point	Y000~Y007(octal)		8	
M	Auxiliary relay	M0~ M2999 【M3000~M7999】		8000	
		M8000~M8767		768	
S	Status	S0~ S511 【S512~M1023】		1024	
T	Timer	T0~T99: 100ms not accumulation		640	
		T100~T199: 100ms accumulation			
		T200~T299: 10ms not accumulation			
		T300~T399: 10ms accumulation			
		T400~T499: 1ms not accumulation			
		T500~T599: 1ms accumulation			
		T600~T618: 1ms with interruption precise time			
		T620~T639: vacant			
C	Counter	C0~C299: 16 bits forth counter		640	
		C300~C318: 32 bits forth/back counter 【C320~C598】: 32 bits forth/back counter			
		【C600~C619】: one phase high speed counter			
		【C620~C629】: Pulse + direction high speed counter			
		【C630~C639】: AB phase high speed counter			
D	Data register	D0~D999 【D4000~D4999】	D0~ D3999 【D4000~D7999】	2000	8000
		For special using D8000~D8511 D8630~D8729	For special using D8000~D9023	612	1024
FD	FlashROM register	FD0~FD127	FD0~FD1535	128	1536
		For special using FD8000~FD8383	For special using FD8000~FD8511	384	512
ED	Extend data register	-	【ED0~ED16383】	-	16384

NOTE:

- ※1. The memorizer area in 【 】 is the defaulted power failure retentive area, the power failure retentive area of soft components D, M, S, T, C can be set via FD register. For the details, please see the following table.
- ※2. Flash ROM register needn't set power failure retentive area, its data won't lose when

power is cut (No battery).

※3. The serial number of input coil and output relay are octal data, other memorizers' number are all decimal data.

※4. There is no I/O point connected with exterior device can be used as interior relay.

Soft component power failure area setting:

XP1/XMP1:

Soft component	Area	Function	Default value	Power failure memory area
D	FD8202	First address of the power failure memory area of D	100	D100~D149
M	FD8203	First address of the power failure memory area of M	200	M200~M319
T	FD8204	First address of the power failure memory area of T	640	No set
C	FD8205	First address of the power failure memory area of C	320	C320~C631
S	FD8206	First address of the power failure memory area of S	512	S0~S31

XP2/XMP2:

Soft component	Area	Function	Default value	Power failure memory area
D	FD8202	First address of the power failure memory area of D	4000	D4000~D4999
M	FD8203	First address of the power failure memory area of M	3000	M3000~M7999
T	FD8204	First address of the power failure memory area of T	640	No set
C	FD8205	First address of the power failure memory area of C	320	C320~C639
S	FD8206	First address of the power failure memory area of S	512	S512~S1023

XP3/XMP3:

Soft component	Area	Function	Default value	Power failure memory area
D	FD8202	First address of the power failure memory area of D	4000	D4000~D7999
M	FD8203	First address of the power failure memory area of M	3000	M3000~M7999
T	FD8204	First address of the power failure memory area of T	640	No set

C	FD8205	First address of the power failure memory area of C	320	C320~C639
S	FD8206	First address of the power failure memory area of S	512	S512~S1023
ED	FD8207	First address of the power failure memory area of ED	0	ED0~ED16383

NOTE:

Users can set the power failure memory area, but the area can not over the soft component area.

3-3. Set up a project

About the software

The PLC program editing software is the same as Xinje XC series. Software name is XCPPro.

The interface of software is as below:

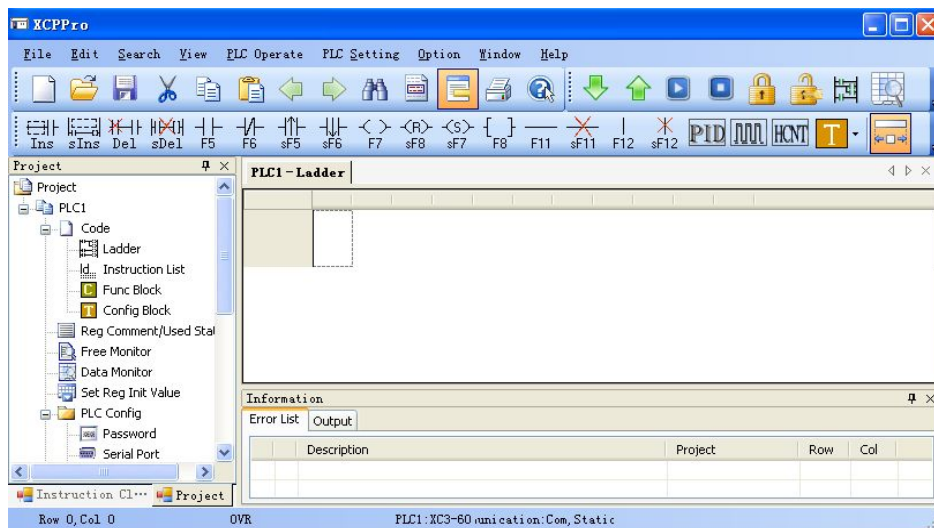

Set up a project

We take XP3-18R as an example to explain how to set up a project.

1. Modify the type

Open the software, click file---change PLC model:

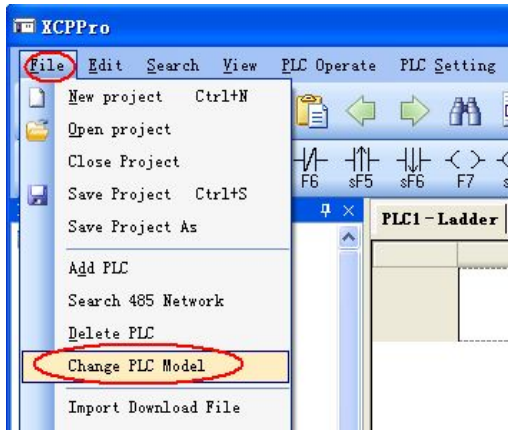

Choose “XP3-18/XMP3-18”:

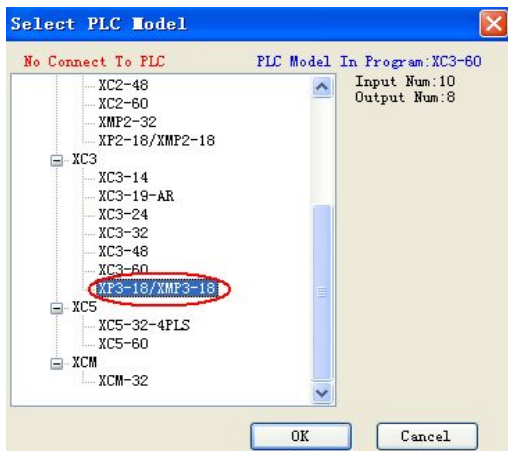

XP1/XMP1series choose
XP1-18/XMP1-18;

XP2/XMP2 series choose
XP2-18/XMP2-18;

XP3/XMP3 series choose
XP3-18/XMP3-18

2. Compile the program

For program compiling and software operating please refer to XC Series Edit Tool XCP Pro User Manual.

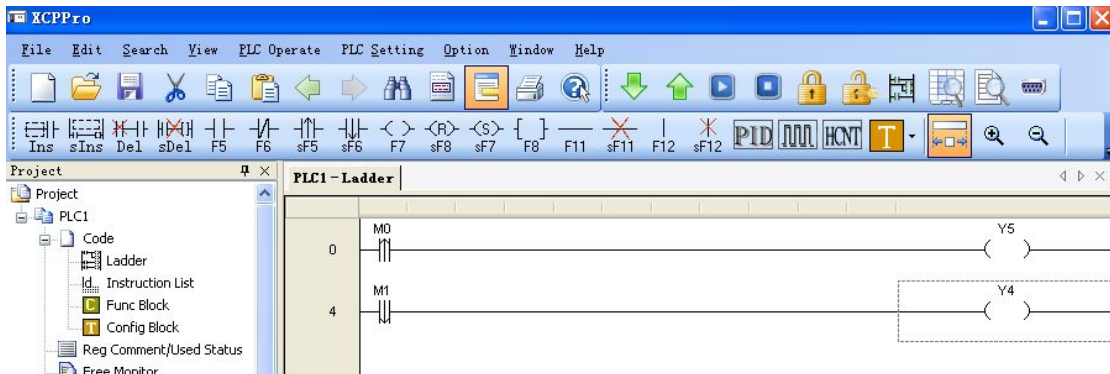

Download the program

1. Connection

Before downloading the program, please ensure the XP/XMP has connected with PC successfully.
(The cable connection please refer to paragraph 1-3).

Click  to open software serial port configuration:

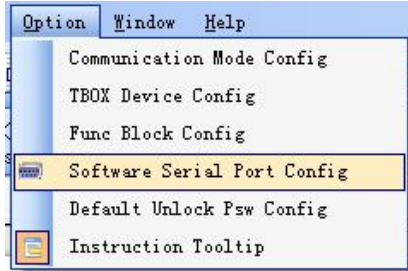

Choose the correct serial port, baudrate and parity or click “check” to choose these parameters automatically.

When below window shows “ connect to PLC succeeded ”, it means the connecting is successful.
Click OK to continue.

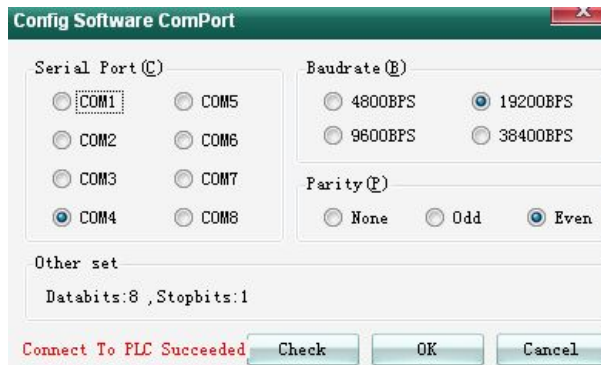

If the connecting is not successful, the window will show “ communication error ”. Please check the serial port and the cable.

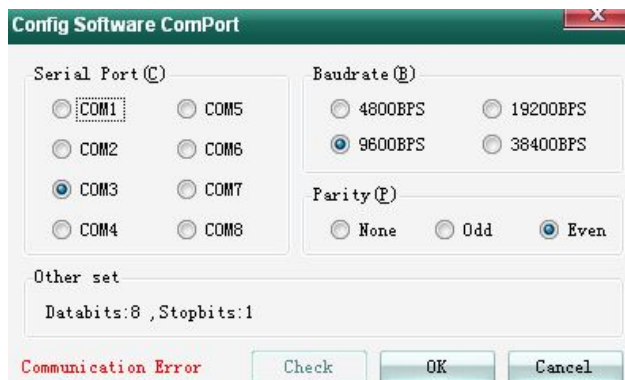

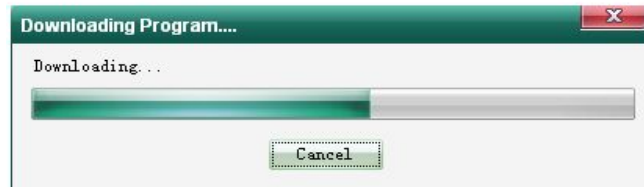

2 Download the program

After connecting successfully, click  to download the PLC program. If the PLC is running, it will pop up the stop running window, click OK to continue downloading.



After downloading, click  to run the PLC program.

3 Upload the program

If you want to check the PLC program in XP/XMP, click  to upload the program to the PC. Then click  to save the program.

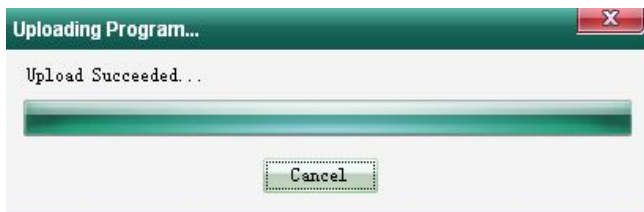

3-4. communication function

XP/XMP series support Modbus and free format communication protocol. The instructions please refer to XC Series PLC Operating Manual paragraph 6-4-1 and 6-4-2.



XP/XMP series product have program port (DB9 pins port) and RS-485 com port (A, B point). Program port can only be used to download PLC program and HMI pictures. However, RS-485 port can be used to communicate with other devices.

RS-485 port can be connected with varied devices, the communication parameters (baud rate, data bit, etc) can be set via software.

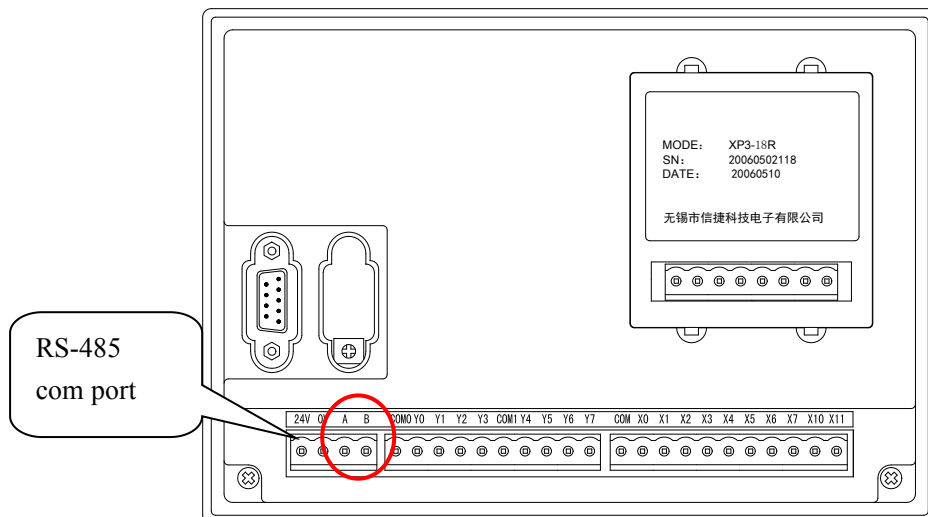

RS-485 com port: Point A means “ + ” signal, point B means “ - ” signal.

Attention:

XP1/XMP1 series product can only be used as slaver station while using their RS-485 port to communicate with other devices.

Communication parameter

Station No.	Modbus station No. : 1-254, 255(FF) is for free format communication
Baud rate	300bps~115.2Kbps
Data bit	8 or 7 bits
Stop bit	2 or 1 bits
Check	Even, odd, no check

The defaulted parameters of the port:

Station number is 1, baud rate is 19200bps, 8 data bit, 1 stop bit, even check

Parameter setting

User can set com port parameters. Please see below list for details.

Attention:

After changing the parameters in Flash register, it is need to reboot the XP/XMP to make the setting become effective.

	Number	Function	Description
AB com port	FD8220	Communication mode (station number)	255 is free format, 1~254 is modbus station number
	FD8221	Communication format	Baud rate, data bit, stop bit, check
	FD8222	ASC timeout judgment time	Unit: ms, 0 means no timeout waiting
	FD8223	Reply timeout judgment time	Unit: ms, 0 means no timeout waiting
	FD8224	Start symbol	High 8 bits invalid
	FD8225	End symbol	High 8 bits invalid
	FD8226	Free format setting	8/16 bits cushion, with/without start bit, with/without stop bit

The way of setting communication parameters:

FD8221:

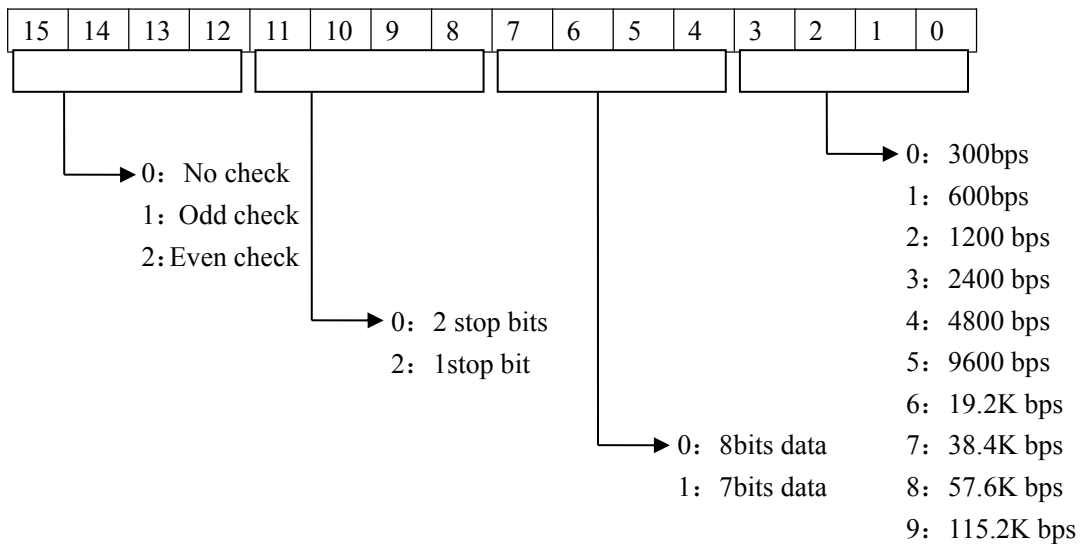

FD8226:

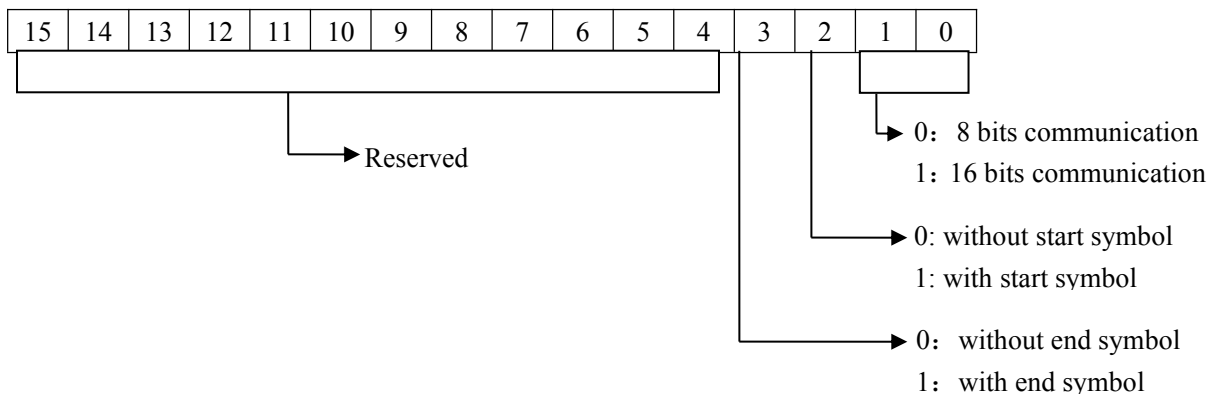

Modbus communication

XMP series product support master and slave mode of Modbus communication protocol.

Master format: When PLC is set to be master station, PLC sends request to other slave station devices via Modbus instructions, other devices respond to the master station.

Slave format: When PLC is set to be slave station, it can only respond to other master devices.

The defaulted status of XMP is Modbus slave mode.

Communication address

The internal soft unit's numbers of XMP are corresponded with Modbus station address numbers, please see the following table:

Coil space: (Modbus address prefix is " 0x ")

Bit component address	Modbus address (decimal K)	Modbus address (hex H)
M0~M7999	0~7999	0~1F3F
X0~X1037(octal)	16384~16927	4000~421F
Y0~Y1037(octal)	18432~18975	4800~4A1F
S0~S1023	20480~21503	5000~53FF
M8000~M8511	24576~25087	6000~61FF
T0~T618	25600~26218	6400~666A
C0~C634	27648~28282	6C00~6E7A

Register space: (Modbus address prefix is " 4x ")

Word component address	Modbus address (decimal K)	Modbus address (hex H)
D0~D7999	0~7999	0~1F3F
TD0~TD618	12288~12906	3000~326A
CD0~CD634	14336~14970	3800~3A7A
D8000~D8511	16384~16895	4000~41FF
FD0~FD5000	18432~23432	4800~5B88
FD8000~FD8511	26624~27135	6800~69FF

Free format communication

Free format communication transfer data in the format of data block, each block can transfer 128 bytes at most. Meanwhile each block can set a start symbol and a end symbol, or not set.











When communicating in free format mode, FD8220 should be 255.

Start Symbol (1 byte)	Data Block (max bytes 128)	End Symbol (1 byte)
-----------------------	-----------------------------	---------------------

4. HMI function and application

4-1. HMI function introduction

The HMI part of XP/XMP used OP330/MP330 series display. The faceplate key-press function is as below:

Key-press	Function
	Whatever the mode of the display is in, it will return to original system screen once you press the key (the defaulted screen is No.1). Generally, set the original system screen to be main menu or most used screen.
	Turn the screen to the last page
	Turn the screen to the next page
	Press the key to modify the register value. The register which is being modified will display in reverse color and the bit will twinkle. If there is no register component in the screen it will do vacancy operation once. Before pressing [ENT] key, press [SET] key again to cancel the setting and continue modifying the next data register.
	To write the modified value in the register and continue modifying next register. After the last register in the screen has been modified, it will quit the setting.
	Alarming list key. After setting the function of alarming list, press this key to jump to the alarming list screen.
	Clear the selected area when modifying the register data.
	Set the positive or negative of the data when modifying the register data.
	Number key 0-9, press the key to set the number you want
	Function key F1-F8

NOTE:

Besides the function listed in the up table, all the keys can be defined as the function of “force ON”, “force OFF”, “reverse” or “momentary ON”.

Please see below picture. Open OP software, put a button in the screen. All the faceplate key-presses are displayed in the key menu, user can set the function as they need.

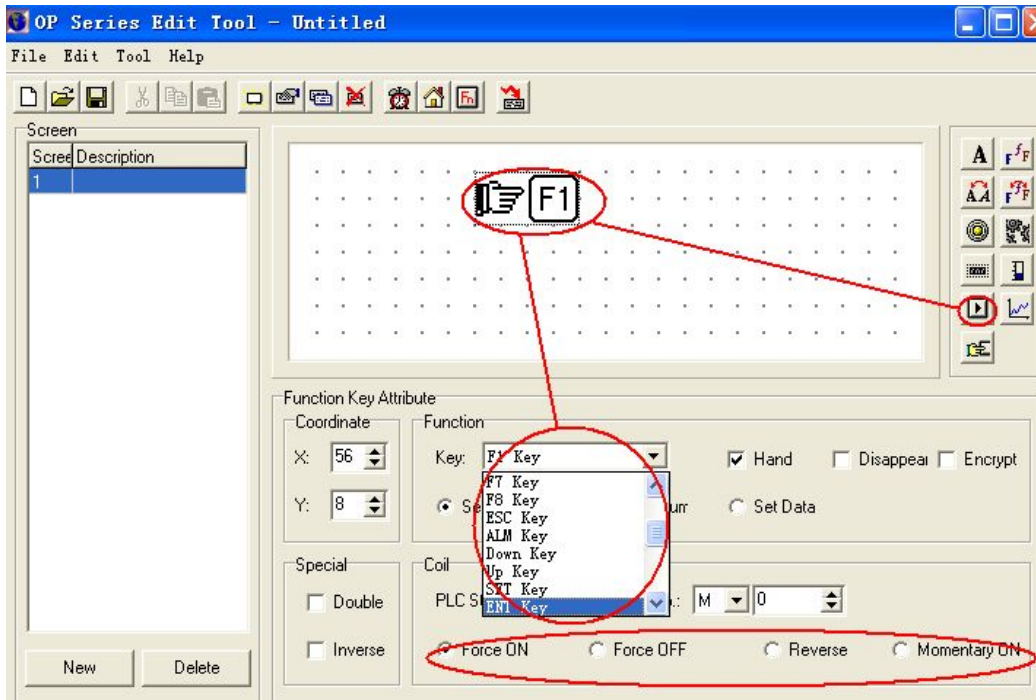

4-2. Build a project

About the software

XP/XMP series product integrated the function of HMI and PLC, when editing the HMI screen, use HMI software OP20.

The interface of OP20 is shown as below:

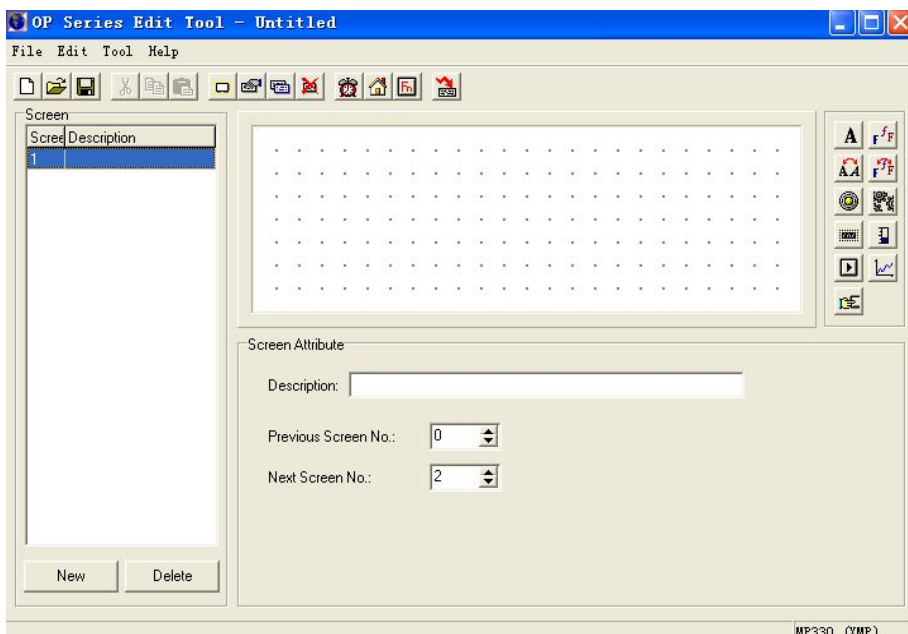

Build a project

We take XMP3-18R as an example to explain how to build a project.

1. build a new project

Open the OP software, click “file”-“new project” or click “” to build a new project.

2. choose the display type

In the “select model” window, choose the correct type of XP/XMP. For this example we select “MP330(XMP)”.

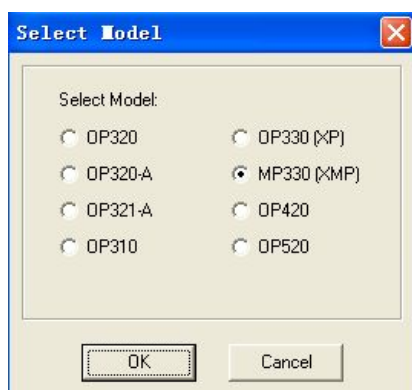

This window shows all the display type supported by OP software.

We can select the correct type according to the content in the bracket.

XP series should select OP330

XMP series should select MP330

3. select PLC type

As the XP/XMP is a integrated product of OP and XC, the OP will communicate with XC inside the product, the communication parameters are defaulted.

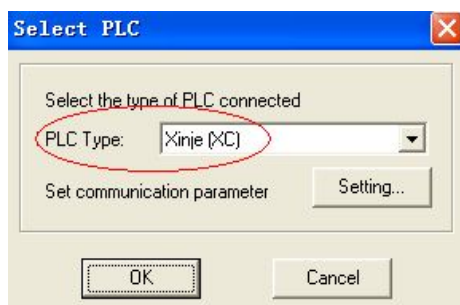

4. edit the screen

After these three steps, we can enter screen editing mode. For the editing details, please refer to OP Series Display User Manual chapter 2.

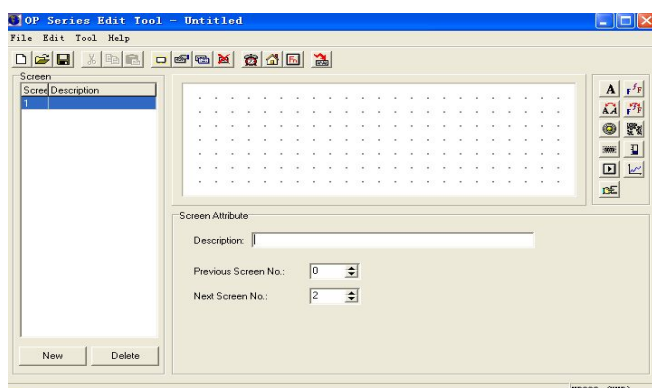

Screen download

1. Select com port

Before downloading the screen, select the correct com port. The port is DB9 pins serial port of PC. The computer will select the port automatically, user only need to know the port number. If user can not confirm which port to use, try each port in file. If the com port is wrong, it will prompt you with the note “can not open”:



Click “file”-“comm port...” to select the correct com port:



2. download

Connect the XP/XMP DB9 pins com port and PC serial port using download cable. Power on the XP/XMP, click  to start downloading:

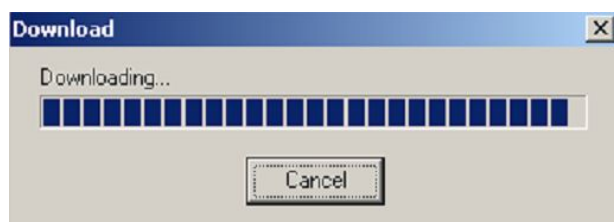

If the downloading is completed, it will pop up below window:



Attention:

- (1) Do not cut the power when downloading, or you have to download again
- (2) The downloading cable of downloading OP screen is the same as downloading PLC program
- (3) Do not download when XCPPro and OP software are both opened

5. The extension ability of XP/XMP

5-1. Extend BD board

XP3/XMP3 series product (exclude XMP2-32R/T-E) can extend XP3 series BD board via the insertion groove at the back in order to control and measure the analog quantity.

The specs and type of BD board is as below table:

BD board type

Type	Function
XP3-2AD2PT-BD	2 channels analog input 2 channels PT100 temperature measurement
XP3-2TC-P-BD	2 channels K thermocouple temperature measurement PID adjustment inside
XP3-2PT2AD1DA-BD	2 channels PT100 temperature measurement 2 channels analog input 1 channel analog output

BD board specs

XP3-2AD2PT-BD:

Item	Voltage input	Temperature input
Analog input signal	DC0~5V、0~10V (Input resistor 300kΩ)	Platinum resistor Pt100 (2-line format)
Temperature measurement range	-	-100~350℃
Distinguish ratio	0.15mV (10/16383)	0.1℃
Digital output range	0~16383	-1000~3500
Integrated precision	±0.8% of the full-scale	
Convert time	15ms×4 channels	
PID output value	0~K4095	
Empty loader defaulted value	0	3500

Input characteristic		
Insulation	No insulation among each channel of PLC	
I/O point	0 point (As it is operated via data register, it is not restricted by master PLC's standard max control points)	

XP3-2TC-P-BD:

Items	Content
Analog input signal	K type thermocouple
Input points	2 points
Temperature measurement range	0°C~970°C
Digital output range	0~9700, 16 bits binary
Output points	2 points
Output format	NPN collector open transistor output
Control precision	0.4°C
Distinguish ratio	0.1°C
Integrated precision	±0.8% (relative max value)
Convert speed	45ms×2 channels
Analog using power	DC24V±10%,50mA

XP3-2PT2AD1DA-BD:

Item	Voltage input	Temperature input	D/A output
Analog input signal	DC0~5V, 0~10V(input resistor 300kΩ)	Platinum resistor Pt100 (2 lines format)	—
Digital input range	—	—	10 bits binary (0-1023)
Analog output range	—	—	0~20mA, 4~20mA
Temperature measurement range	—	-100~350°C	—
Distinguish rate	0.15mV (10/16383)	0.1°C	1/1023
Digital output	0~16383	-1000~3500	—

range			
Integrated precision	±0.8% of the full-scale		
Convert time	15ms×4 channels		
PID output	0~K4095		
Empty loader defaulted value	0	3500	—
In-out characteristics			
insulation	There is no insulation among each channel of PLC		
I/O point	0 point (As it is operated via data register, it is not restricted by master PLC's standard max control points)		

Installation position of BD board

The installation position of BD board on XP3/XMP3 is as below:

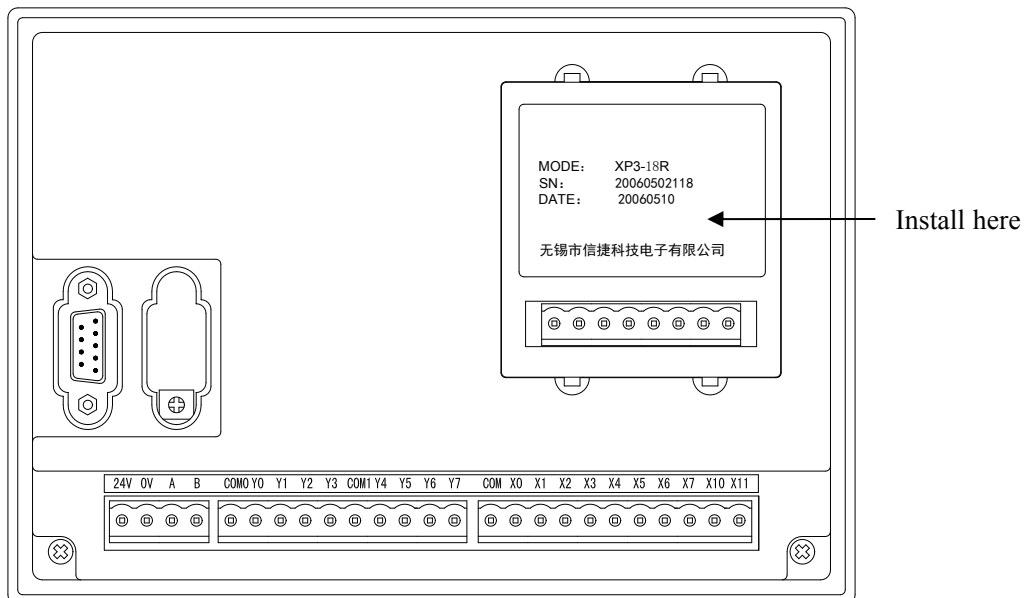

The configuration method and using details please refer to BD Board Manual.

5-2. Extend MA model

XP/XMP can extend MA model via RS-485 com port (A and B point) in order to control and measure analog quantity.

The type and specs of MA model are as below:

MA model type

Type	Function
MA-8X8YR	8 channels digital input, 8 channels digital output
MA-16X	16 channels digital input
MA-16YR/T	16 channels digital output
MA-4DA	4 channels analog output
MA-4AD	4 channels analog input
MA-8AD-A/V	8 channels analog input
MA-4AD2DA	4 channels analog input, 2 channels analog output
MA-6TC-P	6 channels type K thermocouple temperature control
MA-6PT-P	6 channels PT100 temperature control

MA model specs

Type	Description
MA-8X8YR	8 channels digital input, 8 channels digital relay output
MA-16X	16 channels digital input
MA-16YR	16 channels digital relay output
MA-16YT	16 channels digital transistor output

MA-4DA

Item	Voltage output	Current output
Analog output range	DC0~5V、0~10V	DC0~20mA、4~20mA
	(exterior load resistor 2K Ω ~1M Ω)	(exterior load resistor less than 500 Ω)
Digital input range	10 bits binary numbers	
Resolution ratio	1/1023 (10Bit)	
Integrated precision	0.8%	
Conversion speed	3ms/1 channel	
Power of analog quantity	DC24V \pm 10%, 100mA	
Installation	Use M3 screw or fix on DIN46277 rail (width 35mm)	

Profile dimension	63mm×102mm×73.3mm
-------------------	-------------------

MA-8AD-A/V

Item	Voltage	Current
Analog input range	DC0~5V、0~10V	DC0~20mA、4~20mA
	(exterior load resistor 2KΩ~1MΩ)	(exterior load resistor less than 500Ω)
Maximum input range	±18V	0~40mA
Digital output range	12 bits binary numbers	
Resolution	1/4095 (12Bit)	
Integrated precision	0.8%	
Conversion speed	20ms per channel	
Power supply for analog	DC24V±10%, 100mA	
Installation	Use M3 screw or fix on DIN46277 rail (width 35mm)	
Profile dimension	63mm×102mm×73.3mm	

MA-4AD

Item	Analog input (4AD)	
Analog input type	Voltage input	Current input
Analog input range	0~5V,0~10V	0~20mA,4~20mA
Maximum input range	DC±18V	0~40mA
Digital output range	12 bits binary value (0~4095)	
Resolution	1/4095(12Bit)	
PID output range	0~K4095	
Integrated precision	0.8%	
Converting speed	20ms per channel	
Power for analog	DC24V±10%, 100mA	
Installation	Fix up the module with M3 screw or put on DIN46277 rail (width 35mm)	
Profile dimension	63mm×102mm×73.3mm	

MA-4AD2DA

Item	Analog input (4AD)		Analog output (2DA)	
	Voltage input	Current input	Voltage output	Current output
Analog input range	0~5V,0~10V	0~20mA,4~20mA	-	
Max input range	DC±18V	0~40mA	-	
Analog output range	-		0~5V、0~10V, (exterior load resistor 2KΩ~1MΩ)	0~20mA、4~20mA (exterior load resistor less than 500Ω)

Digital input range	-	10 bits binary number (0~1023)
Digital output range	12 bits binary number (0~4095)	-
Resolution	1/4095(12Bit)	1/1023(10Bit)
PID output value	0~K4095	
Integrated precision	0.8%	
Conversion speed	20ms/1 channel	3ms/1 channel
Power supply for analog quantity	DC24V±10%, 100mA	
Installation	Use M3 screw or fix on the DIN46277 (width 35mm) rail	
Profile dimension	63mm×102mm×73.3mm	

MA-6TC-P

Item	Specs
Using environment	0°C ~ 60°C
Measure temperature range	0°C ~ 1000°C
Digital output range	0~4095, 12 bits with sign, binary
Precision	1°C
Integrated precision	1°C
Conversion speed	20ms/1 channel
Power supply for analog	DC24V±10%, 50mA
Installation	Use M3 screw or fix on DIN46277 (width 35mm) rail
Profile dimension	63mm×102mm×73.3mm

MA-6PT-P

Item	Description
Analog input signal	Pt100 Pt hot resistance
Measure temperature range	-100°C ~ 350°C
Digital output range	Full-scale 4095, 12 bits with sign, binary
Control precision	±0.1°C
Resolution	0.1°C
Integrated precision	0.8% (related maximum)
Conversion speed	20ms/1 channel
Power supply for analog	DC24V±10%, 50mA
Installation	Use M3 screw or fix on DIN46277 rail (width 35mm)
Profile dimension	63mm×102mm×73.3mm

MA model connection

XP/XMP can connect with MA model via RS-485 com port (A and B point). It can extend 16 MA models via setting DIP switch of MA model.

Please see the connection figure:

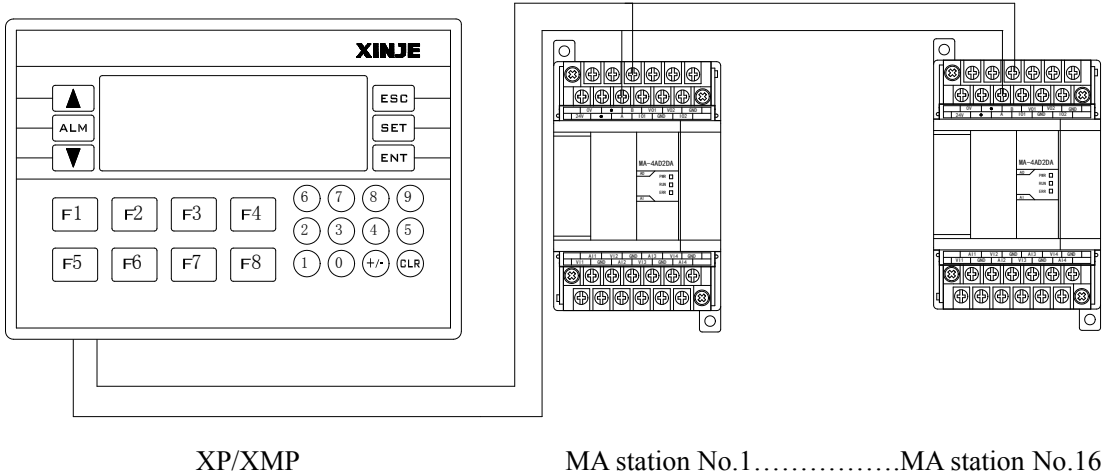

The details and using method please refer to MA Model Manual.

5-3. Other extension

Besides BD board and MA model, XP/XMP series product can extend other devices which support RS-485 and Modbus protocol.

XP/XMP can extend 32 devices via RS-485 com port such as PLC, meter, printer, inverter, HMI etc.

The connection figure is as below:

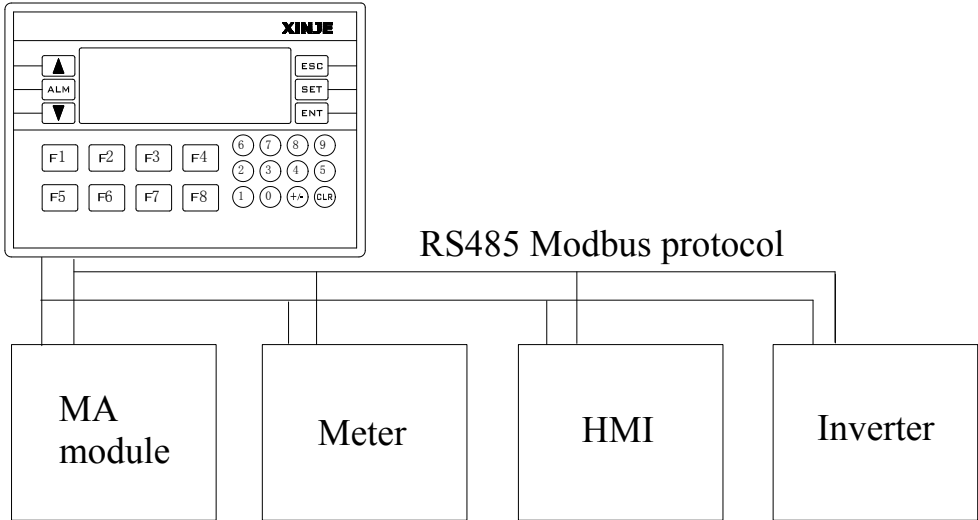

Attention:

The connection method is Bus mode, transmission line should start from station 1 to station 2, then from station 2 to station 3....., connect as this sequence until the last station. Star mode or ring mode connections are not permitted.



WUXI XINJE ELECTRIC CO., LTD.

4th Floor, Building 7th, No.100 Dicui Rd,
Wuxi, China

Tel: 86-0510-85134139

Fax: 86-0510-85111290

www.xinje.com

Email: cheerfiona@gmail.com