

Rising Clamp Interface Terminal Block

■ Features

- New 20-pin models are available on the AFR series (AFR-H20-□)
- Rising clamp type connection method offers simple, easy and durable connection
- Slim and compact design with 5mm terminal pitch
- Ideal for connector type PLCs and dedicated controller I/O
- DIN rail mount and screw mount methods

※Autonics I/O cable CJ Series is recommended.
Refer to I/O cable of I/O terminal block catalogue.

 Please read "Safety considerations" in operation manual before using.



Line-up



■ Model

Model	Item	Terminal type	Connector type	No. of connector pins	Connector	Indicator (LED)	Input logic
AFR-H20	Interface terminal block	Rising clamp	Hirose connector	20	XG4A-2031	None	None
AFR-H20-LN						LED indicator	NPN
AFR-H20-LP						None	PNP
AFR-H40				40	HIF3BA	None	None
AFR-H40-LN						LED indicator	NPN
AFR-H40-LP						None	PNP
AFR-H50	50	HIF3BB	None	None			
AFR-H50B			None	None			

■ Crimp Terminal Specifications

- End Sleeve (ferrule terminal) crimp terminals

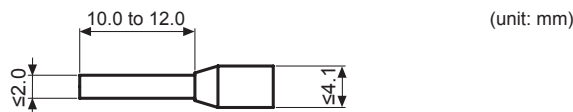

※Applicable wire: AWG22-16 (0.30 to 1.25mm²)

■ Specifications

Model	AFR-H20	AFR-H40	AFR-H50	AFR-H50B	AFR-H20-LN AFR-H20-LP	AFR-H40-LN AFR-H40-LP
Power supply	≤125VDC, 125VAC~ 50/60Hz				24VDC±10%	
Rated current	≤1A					
Terminal type	Rising Clamp					
No. of terminals	20	40	50		16 ^{※2}	32 ^{※3}
Terminal pitch	5.0mm					
Connector type	XG4A-2031	HIF3BA		HIF3BB	XG4A-2031	HIF3BA
Indicator	—				Power indicator: Red LED Operation indicator: Blue LED	
Applicable wire	Solid wire Ø0.3 to Ø1.2mm					
	Stranded wire ^{※4} AWG22-16 (0.30 to 1.25mm ²)					
Stripped wire length	6 to 8mm					
Insulation resistance	≥1,000MΩ (at 500VDC megger)					
Dielectric strength	600VAC 50/60Hz for 1 minute					
Vibration	0.75mm amplitude at frequency of 10 to 55 Hz (for 1 min) in each X, Y, Z direction for 2 hours					
Shock	150m/s ² (approx. 15G) in each X, Y, Z direction for 3 times					
Environ-ment	Ambient temp.	-15 to 55°C, storage: -25 to 65°C				
	Ambient humi.	35 to 85%RH, storage: 35 to 85%RH				
Material	CASE: Polycarbonate, BASE: Polycarbonate					
Tightening torque	0.4 to 0.6N·m					
Protection structure	IP20(IEC standard)					
Approval						
Weight ^{※5}	Approx. 98.7g (approx. 61g)	Approx. 183g (approx. 116g)	Approx. 210g (approx. 143g)		Approx. 98.8g (approx. 61.1g)	Approx. 188g (approx. 118g)

※1: Please connect to a load using the same power supply. Connecting to a load from a different power supply may cause safety issues.

※2: Among 20 terminals, 16 terminals are available for I/O and 4 terminals are LED power.

※3: Among 40 terminals, 32 terminals are available for I/O and 8 terminals are LED power and N-C (Not Connect) terminals.

※4: When using stranded wire, use end sleeve (ferrule terminal) crimp terminals.

※5: The weight includes packaging. The weight in parenthesis is for unit only.

※Environment resistance is rated at no freezing or condensation.

I/O Terminal Blocks

Interface Terminal Block

AFS (screw)

AFL (screwless)

AFR (rising clamp)

Common Terminal Block

ACS (screw)

Sensor Connector Terminal Block

AFE (sensor Connector)

Relay Terminal Block

ABS (screw)

ABL (screwless)

Power Relay (relay terminal block)

I/O Cables

MITSUBISHI

LSIS

Autonics

RS Automation

YOKOGAWA

FUJI

KDT

OMRON

TELEMECANIQUE

For SERVO

Open Type Cables

Cable Appearance

Remote I/O

ARD (DeviceNet Digital Standard Terminal Type)

ARD (DeviceNet Digital Sensor Connector Type)

ARD (DeviceNet Analog Standard Terminal Type)

ARM (Modbus Digital Sensor Connector Type)

Others

Sensor Connectors

Sockets

Sensor Distribution Boxes

Valve Plugs

Thumbwheel Switches

AFR Series

Dimensions

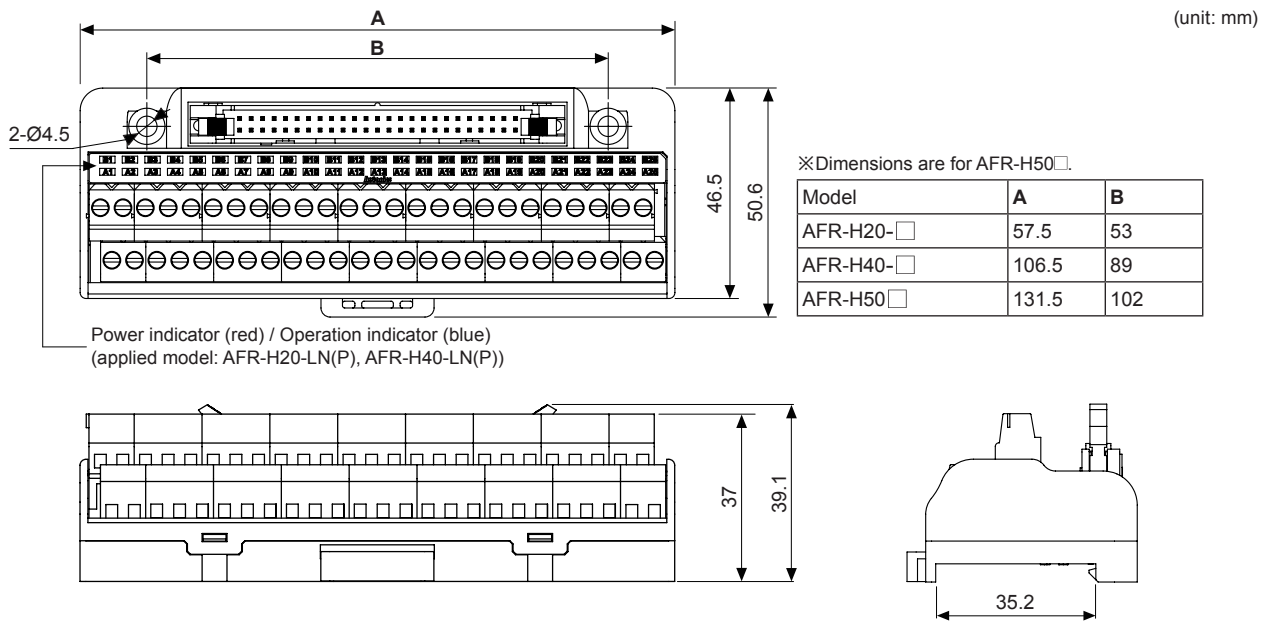

Installation

1. Mounting and Removing from DIN rail

• Mounting

- 1) Pull the rail lock towards direction ①.
- 2) Attach the DIN rail connection part onto the DIN rail.
- 3) Push the unit towards direction ②, then push the rail lock in to lock into position.

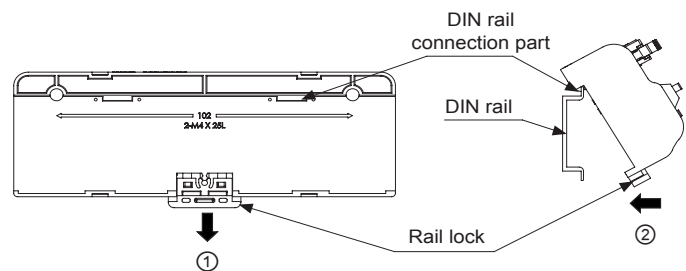

• Removal

- 1) Insert a screwdriver into the rail lock hole and pull it towards direction ③.
- 2) Remove the unit by pulling the unit towards direction ④.

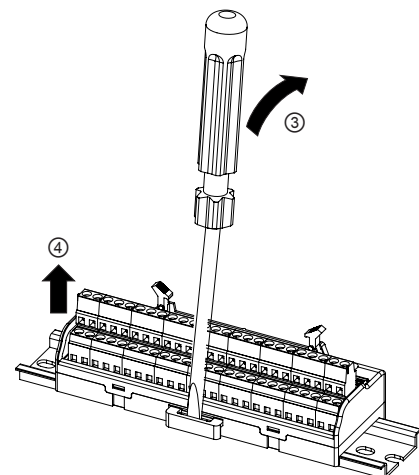

2. Mounting with screws

- 1) The unit can be mounted on panels using the mounting holes next to the Hirose connector.
- 2) M4×25mm spring washer screws are recommended for installation. When using flat washers, use Ø8mm diameter washers. The tightening torque should be between 0.7 to 1.0N·m

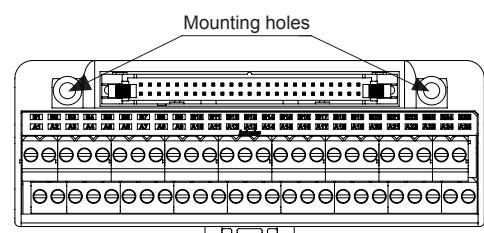

Rising Clamp Interface Terminal Block

■ Connecting Crimp Terminals

● Connection

- 1) Insert a flat-head screw driver into the hole above the terminal. Rotate the screw in direction ① (CCW).
- 2) Push the end sleeve (ferrule terminal) crimp terminal towards direction ②.
- 3) Insert a flat-head screw driver into the hole above the terminal. Rotate the screw in direction ③ (CW).
The tightening torque should be between 0.4 to 0.6 N·m

● Removal

- 1) Insert a flat-head screw driver into the hole above the terminal. Rotate the screw in direction ① (CCW).
- 2) Remove the end sleeve (ferrule terminal) towards direction ④.

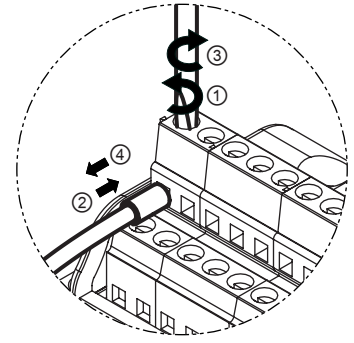

■ Connections

● AFR-H20-□

※Omron connector Model : XG4A-2031

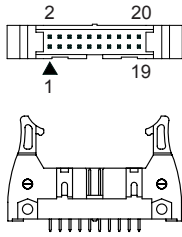

● AFR-H40-□

※Hirose connector Model : HIF3BA-40PA-2.54DSA

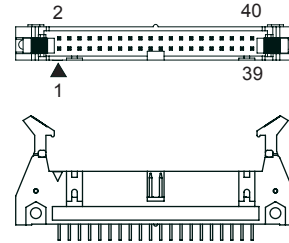

● AFR-H50

※Hirose connector Model : HIF3BA-50PA-2.54DSA

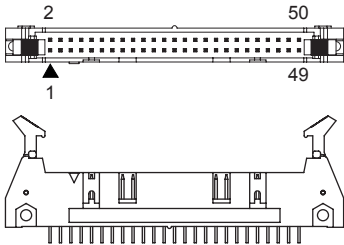

● AFR-H50B

※Hirose connector Model : HIF3BB-50PA-2.54DSA

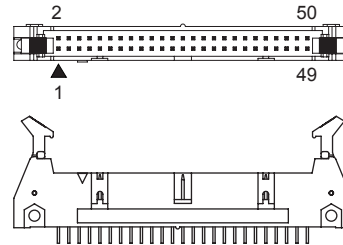

● AFR-H20 / AFR-H40 / AFR-H50□

Connector

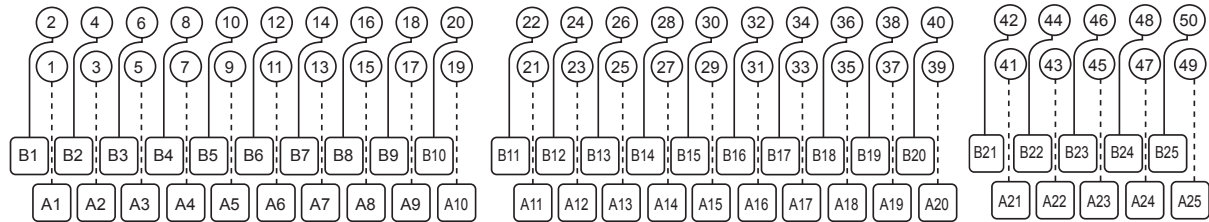

Terminal block



I/O Terminal Blocks

Interface Terminal Block

AFS (screw)

AFL (screwless)

AFR (rising clamp)

Common Terminal Block

ACS (screw)

Sensor Connector Terminal Block

AFE (sensor Connector)

Relay Terminal Block

ABS (screw)

ABL (screwless)

Power Relay (relay terminal block)

I/O Cables

MITSUBISHI

LSIS

Autonics

RS Automation

YOKOGAWA

FUJI

KDT

OMRON

TELEMECANIQUE

For SERVO

Open Type Cables

Cable Appearance

Remote I/O

ARD (DeviceNet Digital Standard Terminal Type)

ARD (DeviceNet Digital Sensor Connector Type)

ARD (DeviceNet Analog Standard Terminal Type)

ARM (Modbus Digital Sensor Connector Type)

Others

Sensor Connectors

Sockets

Sensor Distribution Boxes

Valve Plugs

Thumbwheel Switches

AFR Series

Connections

• AFR-H20-LN

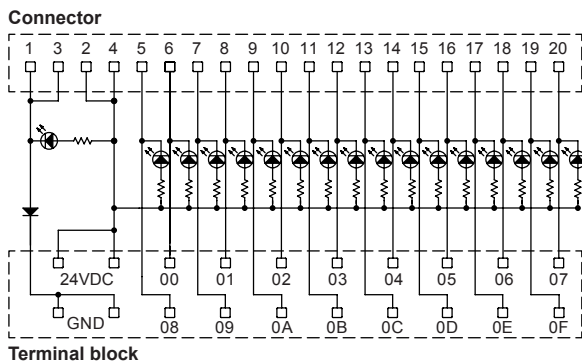

• AFR-H20-LP

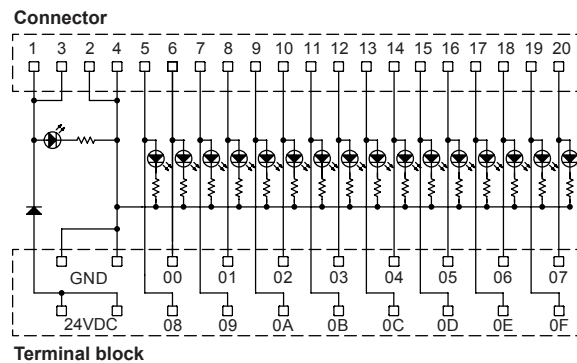

• AFR-H40-LN

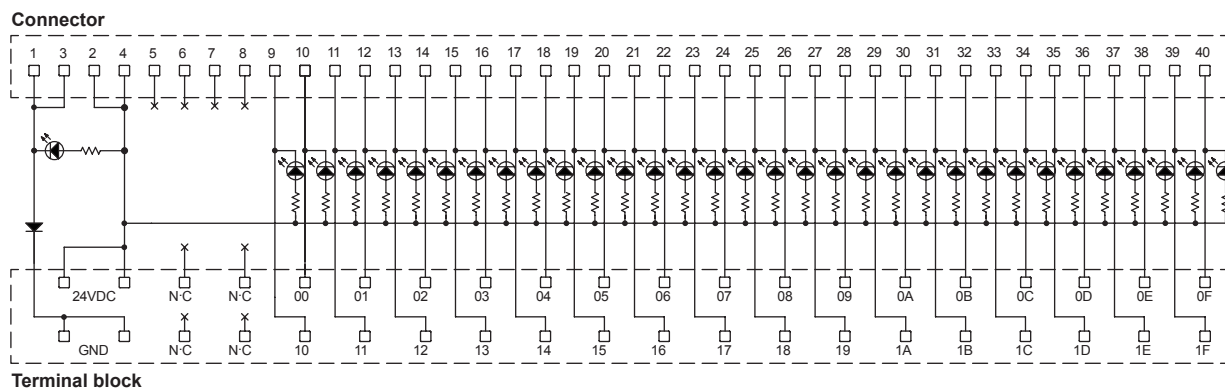

• AFR-H40-LP

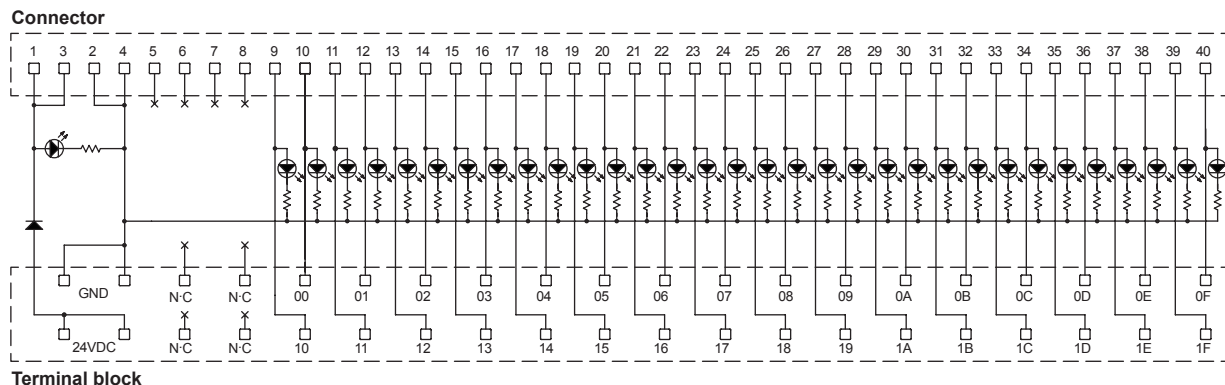

Cautions During Use

1. Use the unit within the rated environment of specification.
2. Supply power within the rated allowable voltage range.
3. Check the polarity of power before connecting PLC or other controllers.
4. When connecting the power input, use Solid wire: $\varnothing 0.3$ to $\varnothing 1.2\text{mm}$, Stranded wire: AWG22-16 (0.30 to 1.25mm^2).
For using crimp terminals, refer to 'Crimp Terminal Specifications'.
5. Do not connect wire or remove connector while connected to a power source.
6. Do not use the unit at below places.
 - ① Environments with high vibration or shock.
 - ② Environments where strong alkalis or acids are used.
 - ③ Environments with exposure to direct sunlight.
 - ④ Near machinery which produce strong magnetic force or electric noise.
7. This unit may be used in the following environments.

① Indoor	② Altitude max. 2,000m
③ Pollution degree 2	④ Installation category II