

KT-502H

Features

- HART protocol
- 330° rotatable display for environment conditions
- 4-20 mA analog output (2-wire)
- Various input
 - RTD: 8 types, Thermocouple: 8 types,
 - mV: 4 types, Ω : 2 types
- Backlight helps to read easily in the darkness
- Explosion-proof structure : Ex d IIC T6(IP67)



Please read "Caution for your safety" in operation manual before using this unit.



Ordering information

KT — 502H 0

Mounting bracket	0	Without bracket
	1	With bracket

Specifications

Model	KT-502H	
Power supply	10.5-45VDC (with backlight LCD)	
Display method	PV display part : 7 Segment 5 digit (character size : W4×H8mm) Parameter display part : 14 Segment 8 digit (character size : W2.6×H4.8mm) 52 Bar meter	
Display range	-19999 to 99999	
Setting method	HART-protocol (no setting key)	
Response time	1 sec.	
Input type	RTD	DPt100 Ω , DPt500 Ω , DPt1000 Ω , Ni100 Ω , Ni500 Ω , Ni1000 Ω , Cu50 Ω , Cu100 Ω
	Thermocouple	K, J, T, E, N, S, B, R
	Resistance tran. (Ω)	0 to 400 Ω , 0 to 2000 Ω
	Voltage trans. (mV)	- 10-75 mV - 100-100 mV - 100-500 mV - 100-2000 mV
Output	4-20 mA(2-wire)	
Alarm	Below 3.8 mA, Over 20.5 mA Sensor break 3.6mA	
Load	max.(V power supply - 7.5V)/0.22A	
Galvanic insulation	2KVAC(input/output)	
Environment	Ambient temperature	-20 to 70 °C, storage: 20 to 80 °C
	Ambient humidity	0 to 85%RH
Explosion-proof structure	Ex d IIC T6(IP67)	
Material	Body : Aluminum(AIDc.8S), Cover O-Ring : Buna N	
Unit weight	Approx. 1.2 kg	

※Environment resistance is rated at no freezing or condensation.

Intelligent Temperature Transmitter

Dimensions

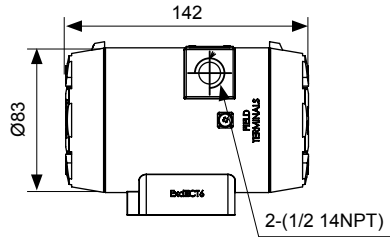
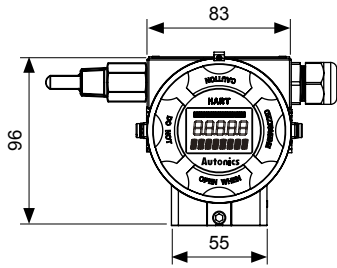

(unit:mm)

• Mounting bracket

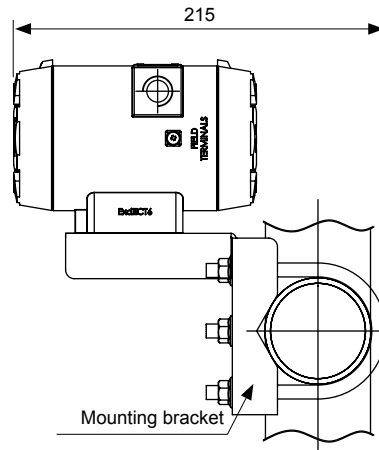
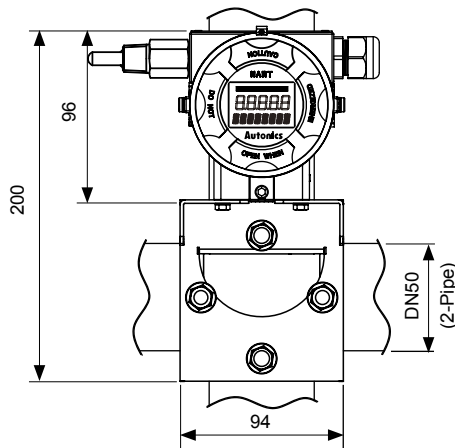

- A. Recorder
- B. Indicator
- C. Converter
- D. Controller
- E. Thyristor unit
- F. Pressure transmitter
- G. Temp. transmitter
- H. Accessories

Input type and range

Input type		Input range(°C)	Input range(°F)
RTD	DPt100Ω	-200 to 850	-328 to 1562
	DPt500Ω	-200 to 250	-328 to 482
	DPt1000Ω	-200 to 250	-328 to 482
	Cu50Ω	-50 to 150	-58 to 302
	Cu100Ω	-50 to 150	-58 to 302
	Ni100Ω	-60 to 180	-76 to 356
	Ni500Ω	-60 to 180	-76 to 356
	Ni1000Ω	-60 to 150	-76 to 302
Resistance (Resistance transmitter)	Resistance (Ω)	0 to 400Ω	
		0 to 2000Ω	
Thermocouple	B (PtRh30-PtRh6)	0 to 1820	32 to 3308
	E(NiCr-CuNi)	-270 to 1000	-454 to 1832
	J(Fe-CuNi)	-210 to 1200	-346 to 2192
	K(NiCr-Ni)	-270 to 1372	-454 to 2501
	N(NiCrSi-NiSi)	-270 to 1300	-454 to 2372
	R(PtRh13-Pt)	-50 to 1768	-58 to 3214.4
	S(PtRh10-Pt)	-50 to 1768	-58 to 3214.4
	T(Cu-CuNi)	-270 to 400	-454 to 752
Analog	Voltage	-10 - 75mV	
		-100 - 100mV	
		-100 - 500mV	
		-100 - 2000mV	

Connections

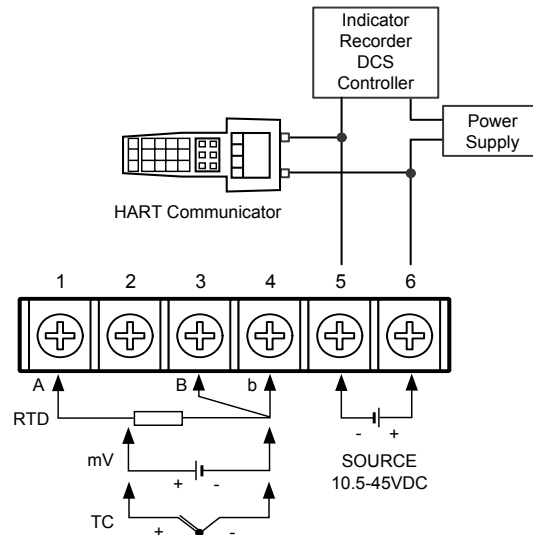

• Mounting bracket

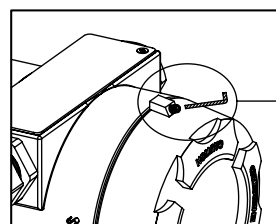

To open the cover, unscrew the M3 X 6L headless bolt using a 1.5 hexagon wrench and rotate the cover.

KT-502H

Current Trim adjustment

- ① Select the '**1. Device Setup**' by ↑, ↓ keys and press the  key.

```

1. Device Setup
2. PV
3. PV Ao
4. PV LRV
5. URV
    
```

- ② Select the '**2. Diag/Service**' by ↑, ↓ keys and press the  key.

```

1. Process Variables
2. Diag/Service
3. Basic Setup
4. Detailed Setup
5. Review
    
```



- ③ Select the '**4. D/A trim**' by ↑, ↓ keys and press the  key.

```

1. Test device
2. Loop test
3. Calibration
4. D/A trim
    
```



- ④ Press the  (F4) key.

```

WARN-Loop should be
removed from
automatic control
 
    
```



- ⑤ Press the  (F4) key.

```

Connect reference
meter
 
    
```





- ⑥ Press the  (F4) key.



```

Setting fid dev
output to 4mA
 
    
```

- ⑦ Press the  (F4) key to set 4 mA display value.



```

Enter meter Value
4.000
   
    
```

- ⑧ If output display value is correct, select '**1. Yes**' and press the  (F4) key. If not, select '**2. No**' and press the  (F4) key and re-set the display value.



Ex) If output display value is 3.89mA, select 3.89 and press the  (F4) key.

```

Fid dev output 4.000
mA equal to reference
meter ?
1. Yes
2. No  
    
```





- ⑨ Press the  (F4) key.



```

Setting fid dev.
output to 20mA
 
    
```



- ⑩ Press the  (F4) key to set 20 mA display value.

```

Enter meter Value
20.000
   
    
```



- ⑪ If output display value is correct, select '**1. Yes**' and press the  (F4) key. If not, select '**2. No**' and press the  (F4) key and re-set the display value.

```

Fid dev output 20.000
mA equal to reference
meter ?
1. Yes
2. No  
    
```



- ⑫ Press the  (F4) key.

```

NOTE-Loop may be
returned to automatic
control
 
    
```



- ⑬ Press the  (F3) key.

```

Diag/Service
1. Test device
2. Loop test
3. Calibration
4. D/A trim
  
    
```

- ⑭ Press the  (F3) key.

```

Device Disconnected
 
    
```

- ⑮ Press the  (F3) key to complete the adjustment.

```

1. Offline
2. Online
3. Frequency Device
4. Utility
    
```

Intelligent Temperature Transmitter

Temperature range setting

① Press the  key for 3 sec.

Select the '4. PV LRV' by ↑, ↓ keys and press the  key.

```

Online (Generic)
1. Device Setup
2. PV
3. PV Ao
4. PV LRV
5. URV          SAVE
    
```

② Select '1. PV LRV'(Low temperature range) and press the  key.

```

1. PV LRV
2. URV
HELP  HOME
    
```

③ Set Low temperature range and press the **ENTER** (F4) key.

```

PV LRV
0.000 deg C
0.000
HELP  DEL  ESC  ENTER
    
```

④ Select '2. URV'(High temperature range) and press the  key.

```

1. PV LRV
2. URV
HELP  HOME
    
```

⑤ Set High temperature range and press the **ENTER** (F4) key.

```

PV URV
100.000 deg C
100.000
HELP  DEL  ESC  ENTER
    
```

⑥ When the set temperature range is correct, press the **SEND** (F2) key.

```

1. PV LRV 0.000 deg C
2. URV 100.000 deg C
HELP  SEND  HOME
    
```

⑦ Press the **OK** (F4) key.

```

- WARNING -
Pressing ' OK ' will
change device output
put 100P in manual
    
```

⑧ Press the **OK** (F4) key.

```

- WARNING -
Return control 100P
To automatic control
      OK
    
```

⑨ Check the set temperature range. Press the **HOME** (F3) key. HART communication is OFF.

```

1. PV LRV 0.000 deg C
2. URV 100.000 deg C
HELP  HOME
    
```

Proper usage

Caution for using

- For connecting the power, use a crimp terminal (M3.5, min. 7.2 mm).
- The connection of this unit should be separated from the power line and high voltage line in order to prevent inductive noise.
- Install a power switch or a circuit breaker to supply or cut off the power.
- Switch or circuit breaker should be installed nearby users for convenient control.
- Do not use this unit near the high frequency instruments (high frequency welding machine & sewing machine, large capacity SCR controller).
- Installation environment.
 - ① Indoor / Outdoor
 - ② Altitude max. 2,000 m
 - ③ Pollution degree 2
 - ④ Installation category II

A. Recorder

B. Indicator

C. Converter

D. Controller

E. Thyristor unit

F. Pressure transmitter

G. Temp. transmitter

H. Accessories

KT-502H