

TCN Series Economical Dual Display Type, PID Control

Economical Dual Display Type, PID Control

Line-up
Connector
plug type
(TCN4S-□-P)

■ Features

- Realizes ideal temp. controlling with newly developed PID control algorithm and 100ms high speed sampling
- Built-in relay output or SSR drive output selectable**
: Enables to phase control and cycle control with SSR drive output (SSRP function)
- Dramatically increased visibility using wide display part
- Enhanced convenience of wiring and maintenance by connector plug type (TCN4S-□-P)
- Mounting space saving with compact design
: Approx. 38% reduced size compared with existing model (depth-based)



⚠ Please read "Caution for your safety" in operation manual before using.



■ Ordering Information

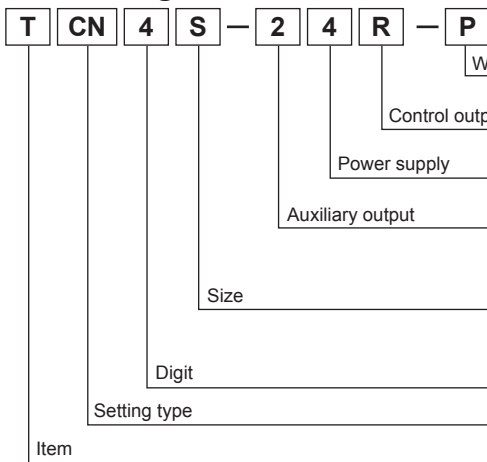

Wiring method	No-mark	Bolt wiring method
	P	Connector plug connection method ^{※1}
Control output	R	Relay contact output+SSR drive output ^{※2}
Power supply	2	24VAC 50/60Hz, 24-48VDC
	4	100-240VAC 50/60Hz
Auxiliary output	2	Alarm1+Alarm2 output
	S	DIN W48×H48mm
	M	DIN W72×H72mm
	H	DIN W48×H96mm
	L	DIN W96×H96mm
Setting type	4	9999 (4digit)
	CN	Dual display type, set by touch switch
Item	T	Temperature controller

※1: Only for TCN4S model.

※2: In case of the AC voltage model, SSR drive output method (standard ON/OFF control, cycle control, phase control) is available to select.

■ Specifications

Series		TCN4S	TCN4M	TCN4H	TCN4L
Power supply	AC power	100-240VAC 50/60Hz			
	AC/DC power	24VAC 50/60Hz, 24-48VDC			
Allowable voltage range		90 to 110% of rated voltage			
Power consumption	AC power	Max. 5VA (100-240VAC 50/60Hz)			
	AC/DC power	Max. 5VA (24VAC 50/60Hz), Max. 3W (24-48VDC)			
Display method		7 Segment (PV: red, SV: green), Other display (green, red) LED			
Character size	PV (W×H)	7.0×15.0mm	9.5×20.0mm	7.0×14.6mm	11.0×22.0mm
	SV (W×H)	5.0×9.5mm	7.5×15.0mm	6.0×12.0mm	7.0×14.0mm
Input type	RTD	DPT100Ω, Cu50Ω (allowable line resistance max. 5Ω per a wire)			
	Thermocouple	K (CA), J (IC), L (IC), T (CC), R (PR), S (PR)			
Display accuracy ^{※1}	RTD	• At room temperature (23°C ±5°C): (PV ±0.5% or ±1°C, select the higher one) ±1digit • Out of room temperature range: (PV ±0.5% or ±2°C, select the higher one) ±1digit For TCN4S-□-P, add ±1°C by accuracy standard.			
	Thermocouple				
Control output	Relay	250VAC 3A 1a			
	SSR	12VDC ±2V 20mA Max.			
Alarm output		AL1, AL2 Relay output: 250VAC 1A 1a			
Control method		ON/OFF control, P, PI, PD, PID control			
Hysteresis		1 to 100°C/°F (0.1 to 50.0°C/°F) variable			

※1: ① At room temperature (23°C ±5°C)

- Thermocouple R (PR), S (PR), below 200°C: (PV ±0.5% or ±3°C, select the higher one) ±1digit
- Thermocouple R (PR), S (PR), over 200°C: (PV ±0.5% or ±2°C, select the higher one) ±1digit
- Thermocouple L (IC), RTD Cu50Ω: (PV ±0.5% or ±2°C, select the higher one) ±1digit

② Out of room temperature range

- Thermocouple R (PR), S (PR), below 200°C: (PV ±1.0% or ±6°C, select the higher one) ±1digit
- Thermocouple R (PR), S (PR), over 200°C: (PV ±0.5% or ±5°C, select the higher one) ±1digit
- Thermocouple L (IC), RTD Cu50Ω: (PV ±0.5% or ±3°C, select the higher one) ±1digit
For TCN4S-□-P, add ±1°C by accuracy standard.

(A) Photoelectric Sensors

(B) Fiber Optic Sensors

(C) Door/Area Sensors

(D) Proximity Sensors

(E) Pressure Sensors

(F) Rotary Encoders

(G) Connectors/ Sockets

(H) Temperature Controllers

(I) SSRs / Power Controllers

(J) Counters

(K) Timers

(L) Panel Meters

(M) Tacho / Speed / Pulse Meters

(N) Display Units

(O) Sensor Controllers

(P) Switching Mode Power Supplies

(Q) Stepper Motors & Drivers & Controllers



(R) Graphic/ Logic Panels

(S) Field Network Devices

(T) Software

TCN Series

Specifications

Series	TCN4S	TCN4M	TCN4H	TCN4L
Proportional band (P)	0.1 to 999.9°C/°F			
Integral time (I)	0 to 9999 sec.			
Derivative time (D)	0 to 9999 sec.			
Control period (T)	0.5 to 120.0 sec.			
Manual reset	0.0 to 100.0%			
Sampling period	100ms			
Dielectric strength	AC Power	2,000VAC 50/60Hz 1min. (between input terminal and power terminal)		
	AC/DC power	1,000VAC 50/60Hz 1min. (between input terminal and power terminal)		
Vibration	0.75mm amplitude at frequency of 5 to 55Hz in each X, Y, Z direction for 2 hours			
Relay life cycle	Mechanical	OUT: Over 5,000,000 times, AL1/2: Over 5,000,000 times		
	Electrical	OUT: Over 200,000 times (250VAC 3A resistive load) AL1/2: Over 300,000 times (250VAC 1A resistive load)		
Insulation resistance	Min. 100MΩ (at 500VDC megger)			
Noise resistance	±2kV R-phase, S-phase the square wave noise (pulse width: 1us) by the noise simulator			
Memory retention	Approx. 10 years (when using non-volatile semiconductor memory type)			
Environment	Ambient temperature	-10 to 50°C, storage: -20 to 60°C		
	Ambient humidity	35 to 85%RH, storage: 35 to 85%RH		
Insulation type	Double insulation or reinforced insulation (mark:  , Dielectric strength between the measuring input part and the power part: AC power 2kV, AC/DC Power 1kV)			
Approval	 			
Weight*2	Approx. 147g (Approx. 100g)	Approx. 203g (Approx. 133g)	Approx. 194g (Approx. 124g)	Approx. 275g (Approx. 179g)

※2: The weight includes packaging. The weight in parentheses is for unit only.
 ※Environment resistance is rated at no freezing or condensation.

Connections

※TCN4 Series has selectable control output; Relay output, and SSR drive output. AC/DC voltage type does not have SSRP function.

TCN4S

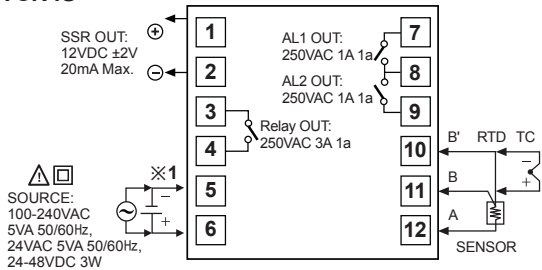

TCN4S-P

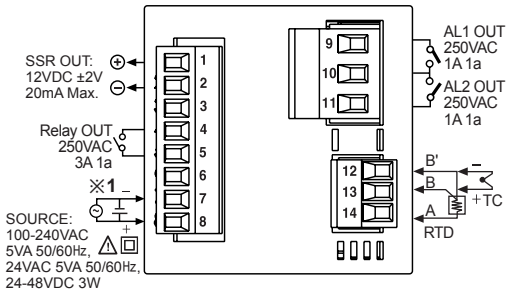

TCN4M

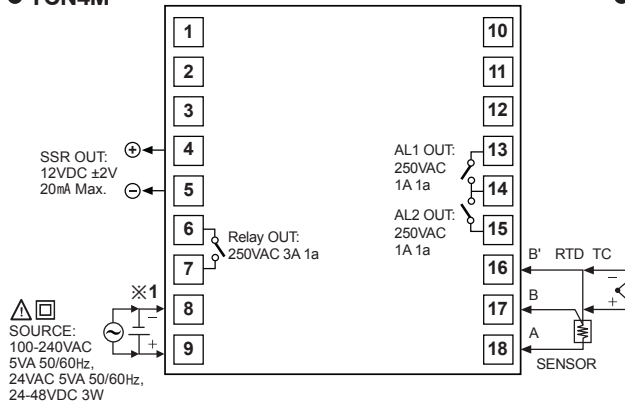

TCN4H/L

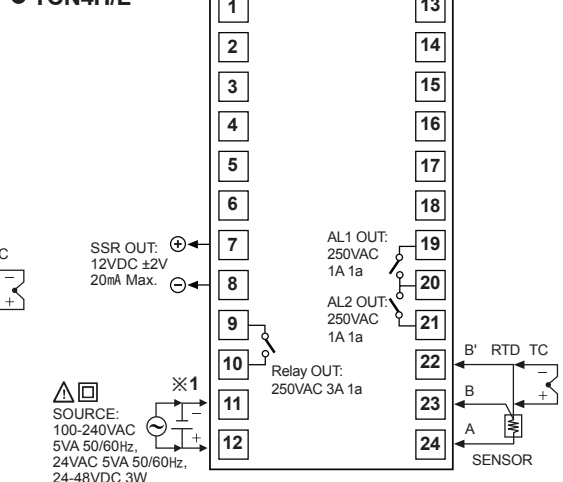

※1: Power supply
 • AC power: 100-240VAC 5VA 50/60Hz
 • AC/DC power: 24VAC 5VA 50/60Hz, 24-48VDC 3W

Economical Dual Display Type, PID Control

■ Dimensions

(unit: mm)

● TCN4S

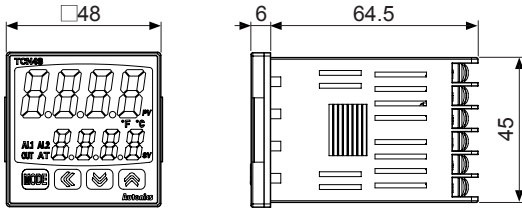

● TCN4S-P

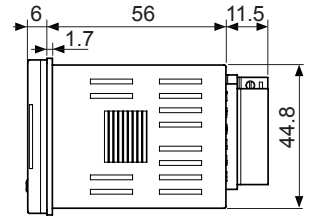

● TCN4M

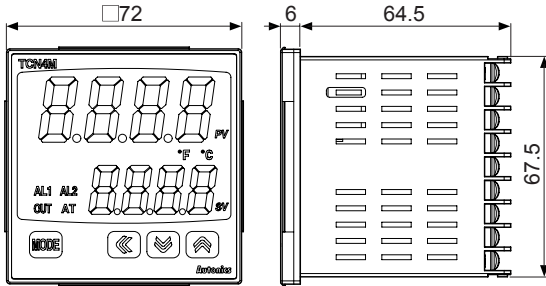

● TCN4H

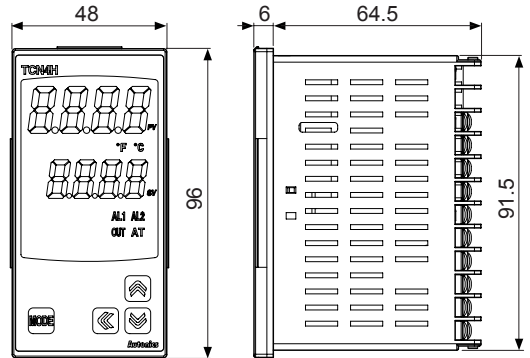

● TCN4L

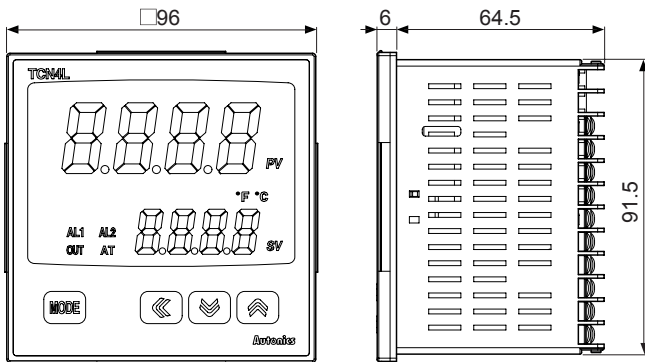

● Panel cut-out

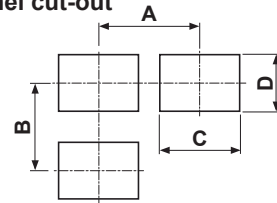

Series	Size	A	B	C	D
TCN4S		Min. 65	Min. 65	45 ^{+0.6} ₀	45 ^{+0.6} ₀
TCN4M		Min. 90	Min. 90	68 ^{+0.7} ₀	68 ^{+0.7} ₀
TCN4H		Min. 65	Min. 115	45 ^{+0.6} ₀	92 ^{+0.6} ₀
TCN4L		Min. 115	Min. 115	92 ^{+0.6} ₀	92 ^{+0.6} ₀

● Bracket

● TCN4S Series

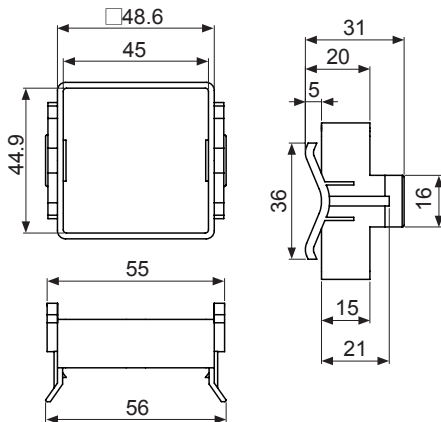

● TCN4M, TCN4H, TCN4L Series

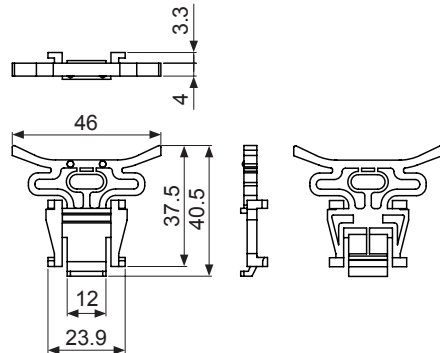

(A) Photoelectric Sensors

(B) Fiber Optic Sensors

(C) Door/Area Sensors

(D) Proximity Sensors

(E) Pressure Sensors

(F) Rotary Encoders

(G) Connectors/ Sockets

(H) Temperature Controllers

(I) SSRs / Power Controllers

(J) Counters

(K) Timers

(L) Panel Meters

(M) Tacho / Speed / Pulse Meters

(N) Display Units

(O) Sensor Controllers

(P) Switching Mode Power Supplies

(Q) Stepper Motors & Drivers & Controllers

(R) Graphic/ Logic Panels

(S) Field Network Devices

(T) Software

TCN Series

■ Dimensions

(unit: mm)

● Terminal cover (sold separately)

● RSA-COVER
(48×48mm)

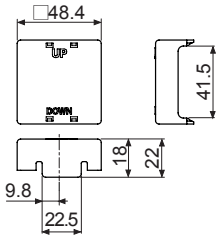

● RMA-COVER
(72×72mm)

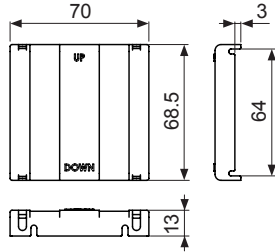

● RHA-COVER
(48×96mm)

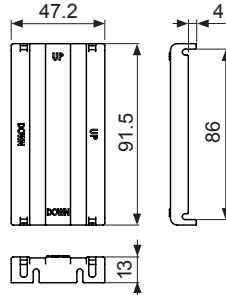

● RLA-COVER
(96×96mm)

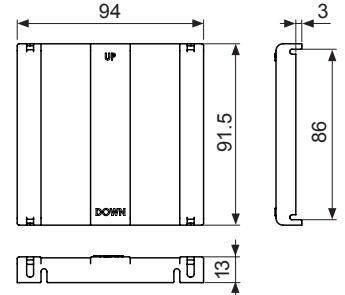

■ Unit Description

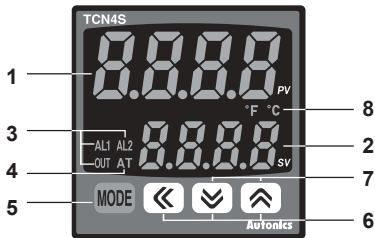

1. Present temperature (PV) display (red)

- RUN mode: Present temperature (PV) display.
- Parameter setting mode: Parameter display.

2. Set temperature (SV) display (green)

- RUN mode: Set temperature (SV) display.
- Parameter setting mode: Parameter setting value display.

3. Control/Alarm output display indicator

- OUT: It turns ON when the control output is ON.
※During SSR drive output type in CYCLE/PHASE control, this indicator turns ON when MV is over 3.0%. (only AC voltage type)
- AL1/AL2: It turns ON when the alarm output is ON.

4. **Auto tuning indicator:** AT indicator flashes by every 1 sec during operating auto tuning.

5. **MODE key:** Used when entering into parameter setting group, returning to RUN mode, moving parameter, and saving setting values.

6. **Adjustment:** Used when entering into set value change mode, digit moving and digit up/down.

7. **Digital input key:** Press $\left[\downarrow \right]$ + $\left[\rightarrow \right]$ keys for 3 sec. to operate the set function (RUN/STOP, alarm output reset, auto tuning) in digital input key [d1 - ƒ].

8. **Temperature unit (°C/°F) indicator:** It shows current temperature unit.

■ SV Setting

You can set the temperature to control with $\left[\text{MODE} \right]$, $\left[\leftarrow \right]$, $\left[\downarrow \right]$, $\left[\rightarrow \right]$ keys.

Setting range is within SV lower limit value [L - 5 \downarrow] to SV higher limit value [H - 5 \downarrow].

E.g.) In case of changing set temperature from 210°C to 250°C

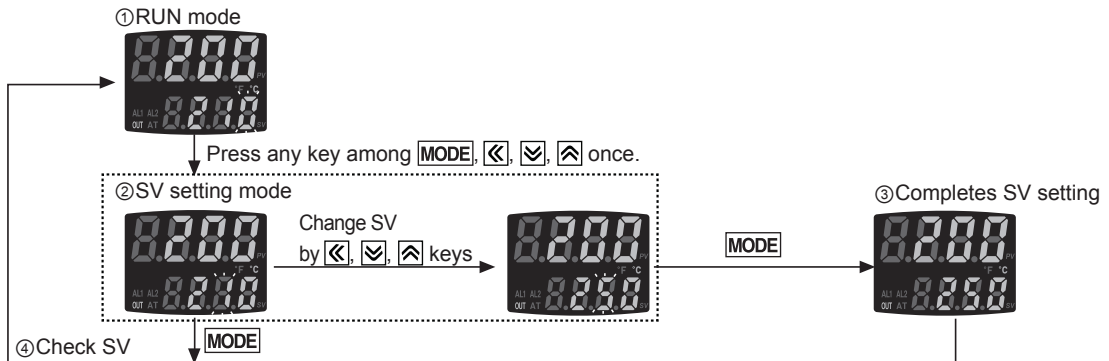

Economical Dual Display Type, PID Control

Parameter Group

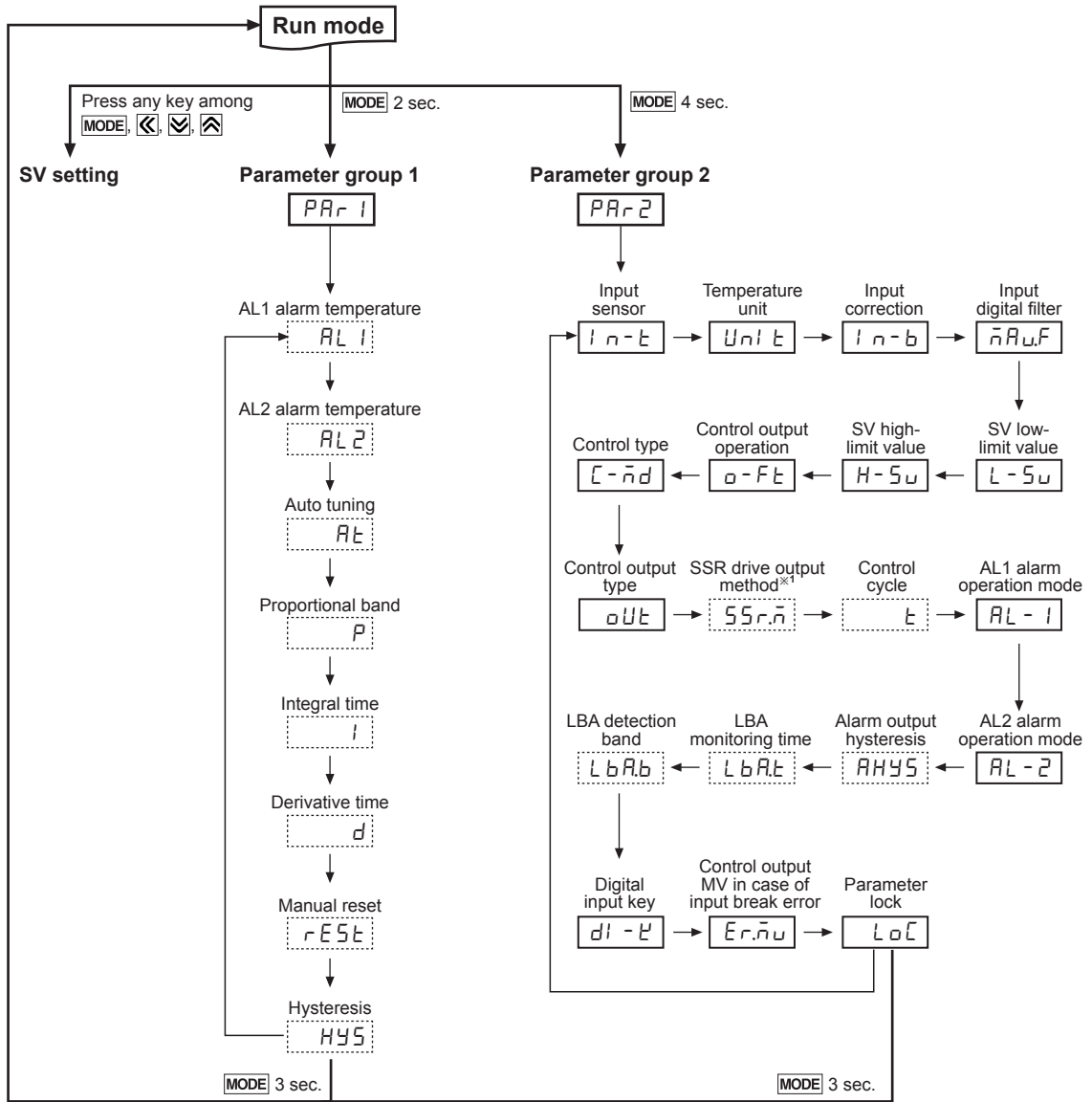

- ※ Press **MODE** key over 3 sec in any setting group, it saves the set value and returns to RUN mode.
(Press **MODE** key once in SV setting, it returns to RUN mode).
- ※ If no key entered for 30 sec., it returns to RUN mode automatically and the set value of parameter is not be saved.
- ※ Press **MODE** key again within 1 sec. after returning to RUN mode, it advances of the first parameter of previous setting group.
- ※ Press **MODE** key to move next parameter.
- ※ { } This parameter might not be displayed depending on other parameter settings.
- ※ Set parameter as 'Parameter group 2 → Parameter group 1 → Setting of set value' order considering parameter relation of each setting group.
- ※ 1: It is not displayed for AC/DC power model (TCN4□-22R).

(A)	Photoelectric Sensors
(B)	Fiber Optic Sensors
(C)	Door/Area Sensors
(D)	Proximity Sensors
(E)	Pressure Sensors
(F)	Rotary Encoders
(G)	Connectors/ Sockets
(H)	Temperature Controllers
(I)	SSRs / Power Controllers
(J)	Counters
(K)	Timers
(L)	Panel Meters
(M)	Tacho / Speed / Pulse Meters
(N)	Display Units
(O)	Sensor Controllers
(P)	Switching Mode Power Supplies
(Q)	Stepper Motors & Drivers & Controllers
(R)	Graphic/ Logic Panels
(S)	Field Network Devices
(T)	Software

Parameter Group 1

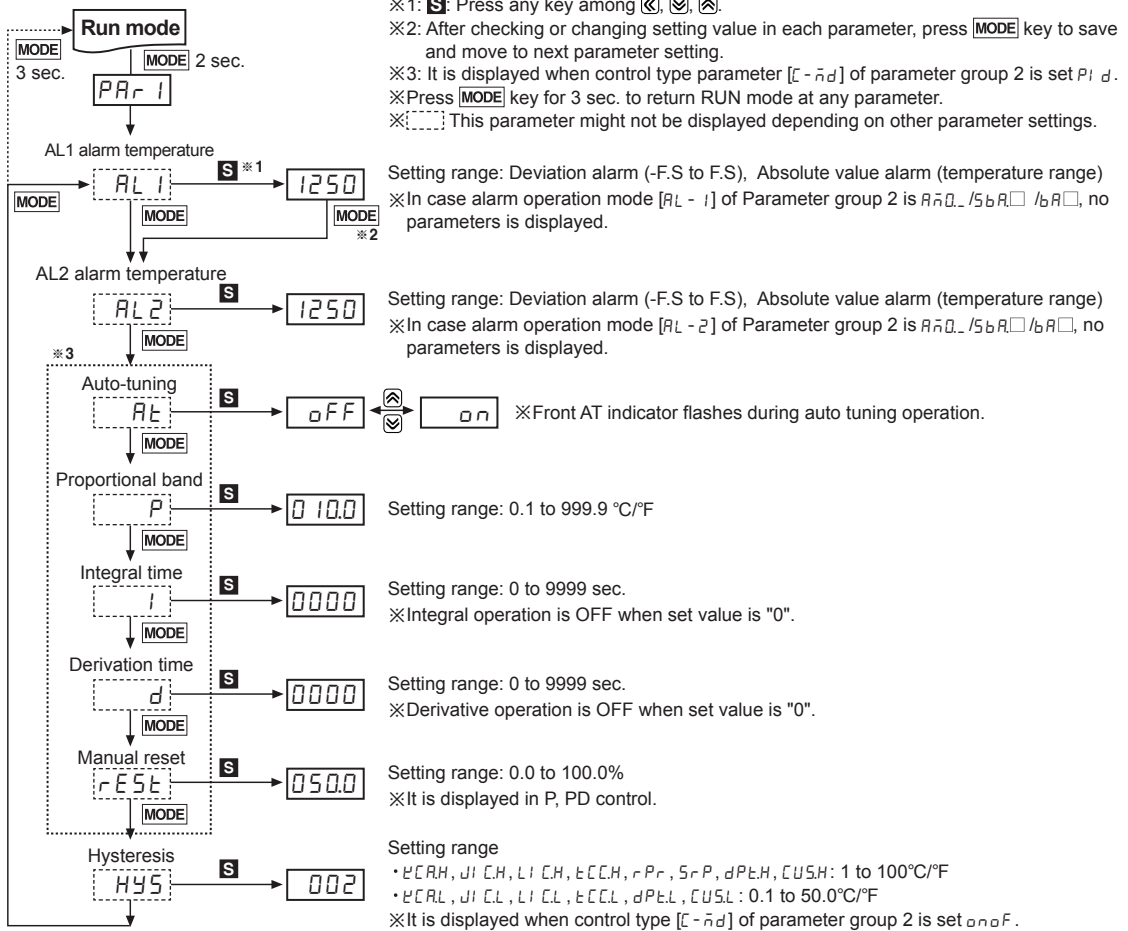

Parameter Group 2

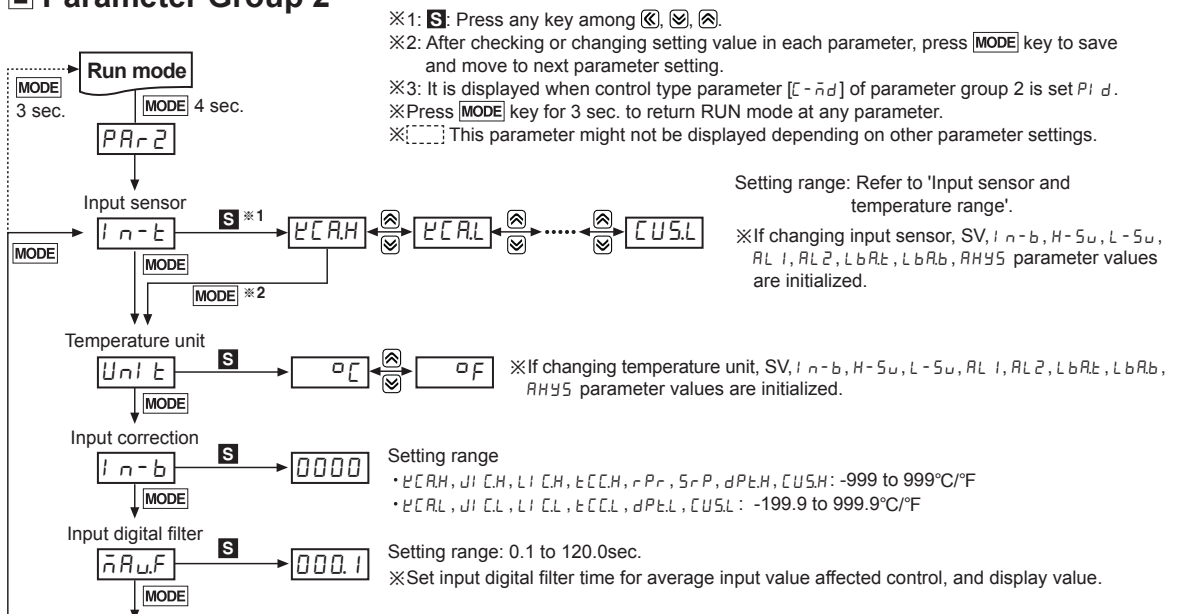

Economical Dual Display Type, PID Control

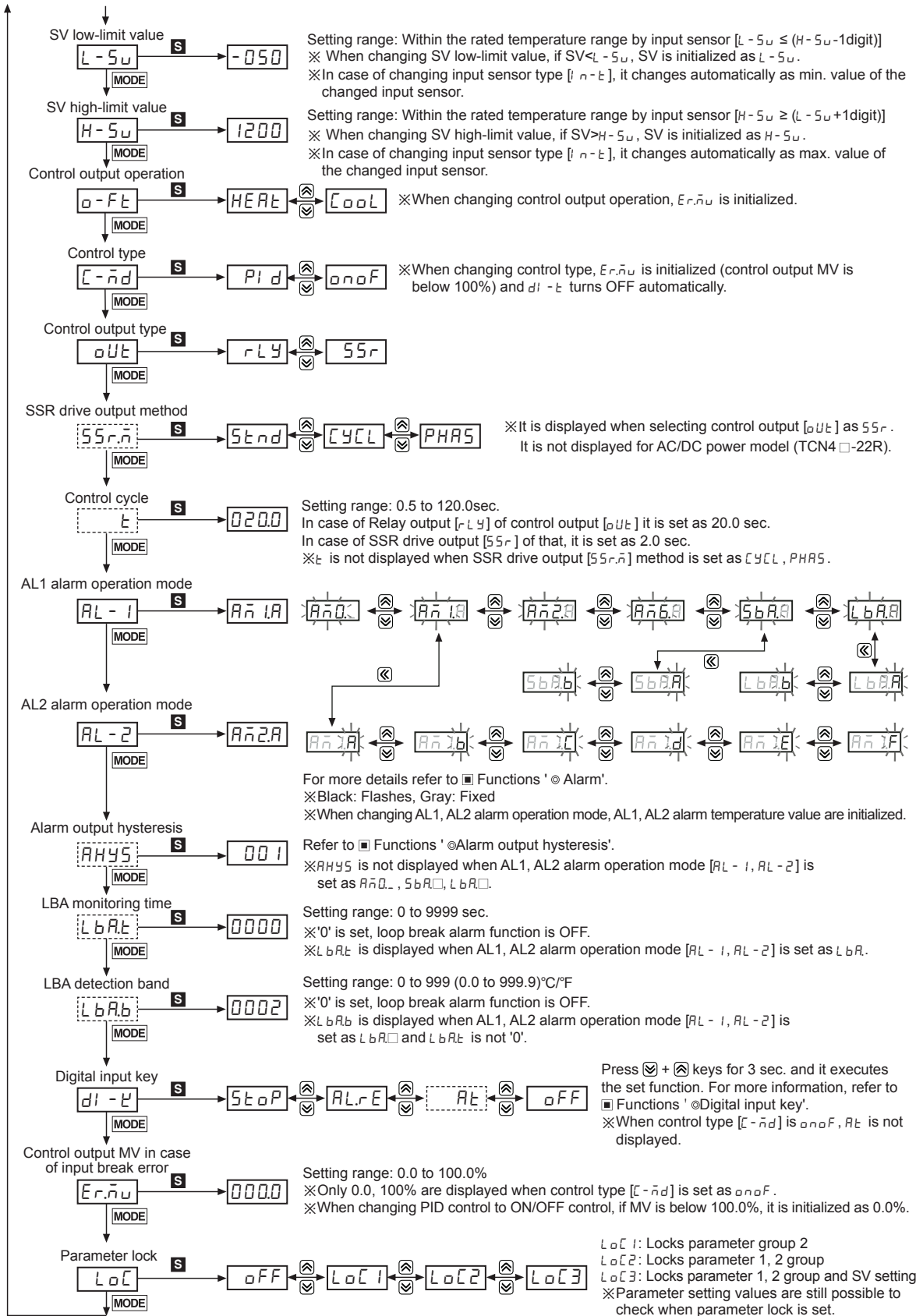

(A)	Photoelectric Sensors
(B)	Fiber Optic Sensors
(C)	Door/Area Sensors
(D)	Proximity Sensors
(E)	Pressure Sensors
(F)	Rotary Encoders
(G)	Connectors/ Sockets
(H)	Temperature Controllers
(I)	SSRs / Power Controllers
(J)	Counters
(K)	Timers
(L)	Panel Meters
(M)	Tacho / Speed / Pulse Meters
(N)	Display Units
(O)	Sensor Controllers
(P)	Switching Mode Power Supplies
(Q)	Stepper Motors & Drivers & Controllers
(R)	Graphic/ Logic Panels
(S)	Field Network Devices
(T)	Software

TCN Series

Input Sensor And Temperature Range

Input sensor		Display	Temperature range (°C)	Temperature range (°F)
Thermocouple	K (CA)	<i>℄CRAH</i>	-50 to 1200	-58 to 2192
		<i>℄CAL</i>	-50.0 to 999.9	-58.0 to 999.9
	J (IC)	<i>℄I CH</i>	-30 to 800	-22 to 1472
		<i>℄I CL</i>	-30.0 to 800.0	-22.0 to 999.9
	L (IC)	<i>℄L CH</i>	-40 to 800	-40 to 1472
		<i>℄L CL</i>	-40.0 to 800.0	-40 to 999.9
	T (CC)	<i>℄TCH</i>	-50 to 400	-58 to 752
		<i>℄TCL</i>	-50.0 to 400.0	-58.0 to 752.0
R (PR)	<i>r Pr</i>	0 to 1700	32 to 3092	
S (PR)	<i>S Pr</i>	0 to 1700	32 to 3092	
RTD	DPT100Ω	<i>dP℄H</i>	-100 to 400	-148 to 752
		<i>dP℄L</i>	-100.0 to 400.0	-148.0 to 752.0
	Cu50Ω	<i>℄U5H</i>	-50 to 200	-58 to 392
		<i>℄U5L</i>	-50.0 to 200.0	-58.0 to 392.0

Factory Default

SV setting

Parameter	Factory default
—	0

Parameter group 1

Parameter	Factory default	Parameter	Factory default	Parameter	Factory default	Parameter	Factory default
<i>AL1</i>	1250	<i>AL</i>	oFF	<i>l</i>	0000	<i>rES</i>	0500
<i>AL2</i>	1250	<i>P</i>	0100	<i>d</i>	0000	<i>HYS</i>	002

Parameter group 2

Parameter	Factory default	Parameter	Factory default	Parameter	Factory default	Parameter	Factory default
<i>ln-t</i>	<i>℄CRAH</i>	<i>H-Su</i>	1200	<i>t</i>	0200	<i>LbAb</i>	0002
<i>Unit</i>	°C	<i>o-Fe</i>	HEAR	<i>AL-1</i>	<i>Añ1.A</i>	<i>d1-℄</i>	5toP
<i>ln-b</i>	0000	<i>C-ñd</i>	PI d	<i>LA-2</i>	<i>Añ2.A</i>	<i>Er-ñu</i>	0000
<i>ñAuF</i>	000.1	<i>oU℄</i>	rLY	<i>AHYS</i>	001	<i>LoC</i>	oFF
<i>L-Su</i>	-050	<i>55r-ñ</i>	5tnd	<i>LbAt</i>	0000		

*The AC/DC voltage models do not have SSR drive output method [55r-ñ]. In case of control output [oU℄], if set as 55r, it supports only ON/OFF output.

Mounting

TCN4S (48×48mm) Series

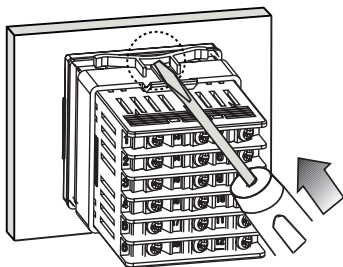

Other Series

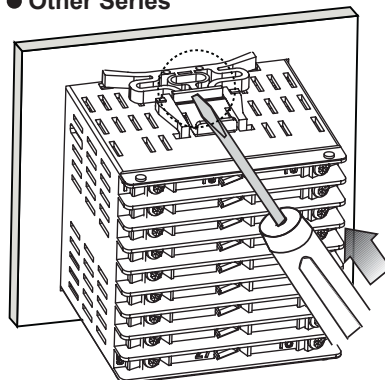

*Mount the product on the panel, fasten bracket by pushing with tools as shown above.

Economical Dual Display Type, PID Control

■ Functions

◎ Alarm [AL - 1 / AL - 2]

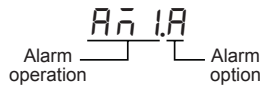

Set both alarm operation and alarm option by combining. Alarm outputs are two and each one operates individually. When the current temperature is out of alarm range, alarm clears automatically. If alarm option is alarm latch or alarm latch and standby sequence 1/2, press digital input key (H) 3 sec., digital input key (d) of parameter group 2 set as AL.rE, or turn OFF the power and turn ON to clear alarm.

● Alarm operation

Mode	Name	Alarm operation	Description
R \bar{n} 0.	—	—	No alarm output
R \bar{n} 1□	Deviation high-limit alarm		If deviation between PV and SV as high-limit is higher than set value of deviation temperature, the alarm output will be ON.
R \bar{n} 2□	Deviation low-limit alarm		If deviation between PV and SV as low-limit is higher than set value of deviation temperature, the alarm output will be ON.
R \bar{n} 3□	Deviation high/low-limit alarm		If deviation between PV and SV as high/low-limit is higher than set value of deviation temperature, the alarm output will be ON.
R \bar{n} 4□	Deviation high/low-limit reverse alarm		If deviation between PV and SV as high/low-limit is higher than set value of deviation temperature, the alarm output will be OFF.
R \bar{n} 5□	Absolute value high limit alarm		If PV is higher than the absolute value, the output will be ON.
R \bar{n} 6□	Absolute value low limit alarm		If PV is lower than the absolute value, the output will be ON.
5bRA□	Sensor break Alarm	—	It will be ON when it detects sensor disconnection.
LbRA□	Loop break Alarm	—	It will be ON when it detects loop break.

※ H: Alarm output hysteresis [RH35]

● Alarm option

Mode	Name	Description
R \bar{n} □A	Standard alarm	If it is an alarm condition, alarm output is ON. If it is a clear alarm condition, alarm output is OFF.
R \bar{n} □b	Alarm latch	If it is an alarm condition, alarm output is ON and maintains ON status.
R \bar{n} □C	Standby sequence 1	First alarm condition is ignored and from second alarm condition, standard alarm operates. When power is supplied and it is an alarm condition, this first alarm condition is ignored and from the second alarm condition, standard alarm operates.
R \bar{n} □d	Alarm latch and standby sequence 1	If it is an alarm condition, it operates both alarm latch and standby sequence. When power is supplied and it is an alarm condition, this first alarm condition is ignored and from the second alarm condition, alarm latch operates.
R \bar{n} □E	Standby sequence 2	First alarm condition is ignored and from second alarm condition, standard alarm operates. When re-applied standby sequence and if it is alarm condition, alarm output does not turn ON. After clearing alarm condition, standard alarm operates.
R \bar{n} □F	Alarm latch and standby sequence 2	Basic operation is same as alarm latch and standby sequence 1. It operates not only by power ON/OFF, but also alarm setting value, or alarm option changing. When re-applied standby sequence and if it is alarm condition, alarm output does not turn ON. After clearing alarm condition, alarm latch operates.

※ Condition of re-applied standby sequence for standby sequence 1, alarm latch and standby sequence 1: Power ON
 Condition of re-applied standby sequence for standby sequence 2, alarm latch and standby sequence 2: Power ON, changing set temperature, alarm temperature [AL 1, AL 2] or alarm operation [AL - 1, AL - 2], switching STOP mode to RUN mode.

◎ Sensor break alarm

The function that alarm output will be ON when sensor is not connected or when sensor's disconnection is detected during temperature controlling. You can check whether the sensor is connected with buzzer or other units using alarm output contact. It is selectable between standard alarm [5bRA], or alarm latch [5bRb].

(A) Photoelectric Sensors

(B) Fiber Optic Sensors

(C) Door/Area Sensors

(D) Proximity Sensors

(E) Pressure Sensors

(F) Rotary Encoders

(G) Connectors/ Sockets

(H) Temperature Controllers

(I) SSRs / Power Controllers

(J) Counters

(K) Timers

(L) Panel Meters

(M) Tacho / Speed / Pulse Meters

(N) Display Units

(O) Sensor Controllers

(P) Switching Mode Power Supplies

(Q) Stepper Motors & Drivers & Controllers

(R) Graphic/ Logic Panels

(S) Field Network Devices

(T) Software

◎ Loop break alarm (LBA)

It checks control loop and outputs alarm by temperature change of the subject. For heating control (cooling control), when control output MV is 100% (0% for cooling control) and PV is not increased over than LBA detection band [L b R b] during LBA monitoring time [L b R t], or when control output MV is 0% (100% for cooling control) and PV is not decreased below than LBA detection band [L b R b] during LBA monitoring time [L b R t], alarm output turns ON.

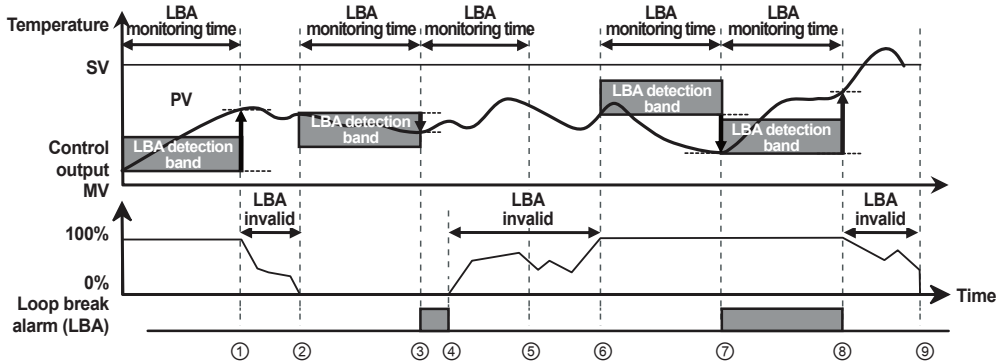

Start control to ①	When control output MV is 0% and PV is not decreased below than LBA detection band [L b R b] during LBA monitoring time [L b R t]
① to ②	The status of changing control output MV (LBA monitoring time is reset.)
② to ③	When control output MV is 0% and PV is not decreased below than LBA detection band [L b R b] during LBA monitoring time [L b R t] loop break alarm (LBA) turns ON after LBA monitoring time.
③ to ④	Control output MV is 0% and loop break alarm (LBA) turns and maintains ON.
④ to ⑥	The status of changing control output MV (LBA monitoring time is reset.)
⑥ to ⑦	When control output MV is 100% and PV is not increased over than LBA detection band [L b R b] during LBA monitoring time [L b R t], loop break alarm (LBA) turns ON after LBA monitoring time.
⑦ to ⑧	When control output MV is 100% and PV is increased over than LBA detection band [L b R b] during LBA monitoring time [L b R t] loop break alarm (LBA) turns OFF after LBA monitoring time.
⑧ to ⑨	The status of changing control output MV (LBA monitoring time is reset.)

※When executing auto-tuning, LBA detection band [L b R b] and LBA monitoring time are automatically set based on auto tuning value. When AL1, AL2 alarm operation [AL - 1, AL - 2] is set as loop break alarm (LBA) [L b R □], LBA detection band [L b R b] and LBA monitoring time [L b R t] parameter is displayed.

◎ SSR drive output function (SSRP function) [5 5 r . n̄]

- SSRP function is selectable one of standard ON/OFF control, cycle control, phase control by utilizing standard SSR drive output.
- Realizing high accuracy and cost effective temperature control as linear output(cycle control and phase control).
- Select one of standard ON/OFF control [5 t n d], cycle control [C Y C L], phase control [P H R 5] at [5 5 r . n̄] parameter group 2. For cycle control, connect zero cross turn-on SSR or random turn-on SSR. For phase control, connect random turn-on SSR.

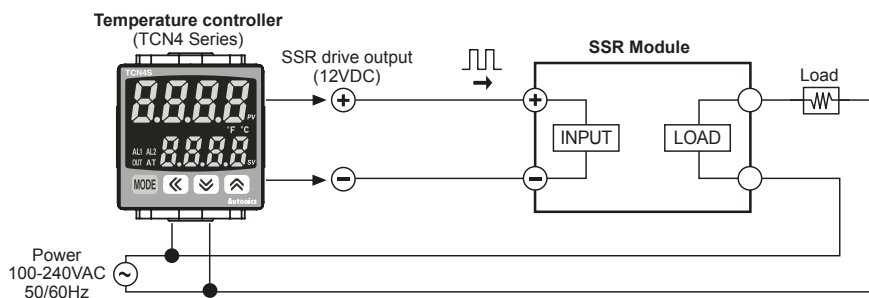

※When selecting phase or cycle control mode, the power supply for load and temperature controller must be the same.

※In case of selecting PID control type and phase [P H R 5] / cycle [C Y C L] control output modes, control cycle [t] is not allowed to set.

※For AC/DC power model (TCN4 □ -22R), this parameter is not displayed and it is available only standard control by relay or SSR.

Economical Dual Display Type, PID Control

● Standard ON/OFF control mode [5tnd]

A mode to control the load in the same way as Relay output type.
(ON: output level 100%, OFF: output level 0%)

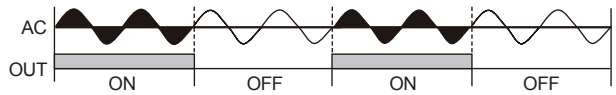

● Cycle control mode [CYCL]

A mode to control the load by repeating output ON / OFF according to the rate of output within setting cycle.
Having improved ON / OFF noise feature by Zero Cross type.

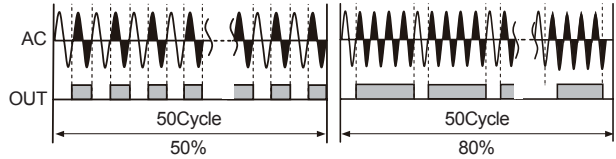

● Phase control mode [PHAS]

A mode to control the load by controlling the phase within AC half cycle. Serial control is available.
RANDOM Turn-on type SSR must be used for this mode.

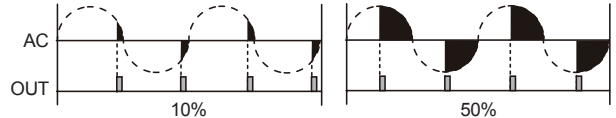

◎ Auto tuning [At]

- Auto tuning measures the control subject's thermal characteristics and thermal response rate, and then determines the necessary PID time constant. (When control type [C-nd] is set as PID, it is displayed.)
- If error [PEN] occurs during auto tuning, it stops this operation automatically.
- To stop auto tuning, change the set as OFF. (It maintains P, I, D values of before auto tuning.)

◎ Input correction [In-b]

Controller itself does not have errors but there may be error by external input temperature sensor.

E.g.) If actual temperature is 80°C but controller displays 78°C, set input correction value [In-b] as 002 and controller displays 80°C.

※As the result of input correction, if current temperature value (PV) is over each temperature range of input sensor, it displays HHHH or LLLL.

◎ Input digital filter [nRWF]

If current temperature (PV) is fluctuating repeatedly by rapid change of input signal, it reflects to MV and stable control is impossible. Therefore, digital filter function stabilizes current temperature value.

- For example, set input digital filter value as 0.4 sec, and it applies digital filter to input values during 0.4 sec and displays this values. Current temperature may be different by actual input value.

◎ SV High/Low limit [H-5u/L-5u]

- It sets SV high/low limit range of using temperature within temperature range for each sensor, user can set/change set temperature (SV) within SV high limit [H-5u] to SV low limit [L-5u]. (※ L-5u > H-5u cannot be set.)
- When changing input type [In-t], SV high limit [H-5u] and SV low limit [L-5u] of using temperature will be initialized as max./min.value of sensor temperature range automatically.

◎ Hysteresis [HY5]

- In case of ON/OFF control, set between ON and OFF intervals as hysteresis. (When control type [C-nd] is set as ONOFF, it is displayed.)
- If hysteresis is too small, it may cause control output hunting (take off, chattering) by external noise, etc.

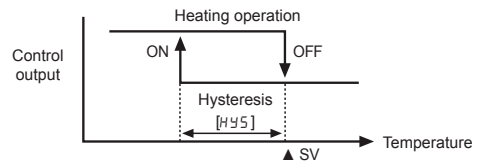

◎ Manual reset [rE5t]

When selecting P/PD control mode, certain temperature difference exists even after PV reaches stable status because heater's rising and falling time is inconsistent due to thermal characteristics of controlled objects, such as heat capacity, heater capacity. This temperature difference is called offset and manual reset [rE5t] function is to set/correct offset.

- When PV and SV are equal, reset value is 50.0%. After control is stable, PV is lower than SV, reset value is over 50.0% or PV is higher than SV, reset value is below 50.0%.
- Manual reset [rE5t] by control result

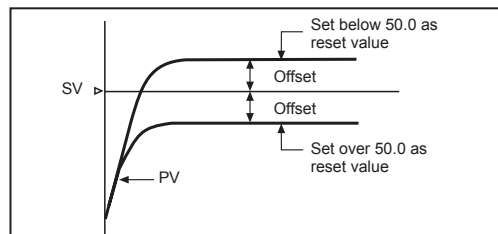

※Manual reset function is applicable only to P / PD control mode.

◎ Temperature unit selection [Unit]

- A function to select display temperature unit.
- Unit display indicator will be ON when converting temperature unit.

(A) Photoelectric Sensors

(B) Fiber Optic Sensors

(C) Door/Area Sensors

(D) Proximity Sensors

(E) Pressure Sensors

(F) Rotary Encoders

(G) Connectors/Sockets

(H) Temperature Controllers

(I) SSRs / Power Controllers

(J) Counters

(K) Timers

(L) Panel Meters

(M) Tacho / Speed / Pulse Meters

(N) Display Units

(O) Sensor Controllers

(P) Switching Mode Power Supplies

(Q) Stepper Motors & Drivers & Controllers

(R) Graphic/Logic Panels

(S) Field Network Devices

(T) Software

TCN Series

◎ Cool / Heat function [α - F E]

Generally there are two ways to control temperature, one (heat-function) is to heat when PV is getting down (heater). The other (cool-function) is to cool when PV is getting higher (freezer).

These functions are operating oppositely when it is ON/OFF control or proportional control. But in this case PID time constant will be different due to PID time constant will be decided according to control system when it is PID control.

- Cool-function [C O O L] and heat-function [H E A T] must be set correctly according to the application, if set as opposite function, it may cause a fire. (If set cool-function [C O O L] at heater, it will be maintained ON and it may cause a fire.)
- Avoid changing heat-function to cool-function or cool-function to heat-function when the unit is operating.
- It is impossible to operate both function at once in this unit. Therefore, only one function should be selected only.

◎ Control method selection [C - n d]

It is selectable PID, ON/OFF control.

- In case of ON/OFF [O N O F] mode, Hysteresis [H Y S] parameter is displayed.
- In case of PID [P I D] mode, Proportional band [P], Integral time [I], and Derivative time [T] parameters are displayed.

◎ Digital input key (☑ + ⏏ 3sec.) [d I - E]

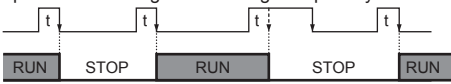
Parameter	Operation
OFF	o F F It does not use digital input key function.
RUN/STOP	S t o P Pauses control output. Auxiliary output (except loop break alarm, sensor break alarm)except Control output operates as setting. Hold the digital input keys for 3 sec. to restart. 
Clear alarm	A L r E Clears alarm output by force. (only when alarm option is alarm latch, or alarm latch and standby sequence 1/2 .) This function is applied when present value is out of alarm operation range but alarm output is ON. Alarm operates normally right after clearing alarm.
Auto-tuning	A t Starts/Stops auto-tuning. This function is same as auto-tuning[A t] of parameter group 1. (You can start auto-tuning [A t] of parameter group 1 and stop it by digital input key.) ※ This parameter A t appears only when control method [C - n d] parameter group 2 is set as P I D . When control method [C - n d] parameter group 2 is set as O N O F , this parameter is changed as o F F .

◎ Parameter lock [L o C]

A function to prevent changing SV and parameters of each setting group. Parameter setting values are still possible to check when parameter lock is set.

Display	Description
o F F	Lock off
L o C 1	Lock parameter group 2
L o C 2	Lock parameter group 1, 2
L o C 3	Lock parameter group 1, 2, SV setting

◎ Control output type selection [r L y]

It is selectable output type ; relay output [r L y], SSR drive output [S S r].

◎ Alarm output hysteresis [A H Y S]

It displays alarm output ON and OFF interval and hysteresis is applied to both AL1 OUT and AL2 OUT.

- E C R H , d I C H , L I C H , t C C H , r P r , S P r , d P E H , C U S H : 1 to 100
 - E C R L , d I C L , L I C L , t C C L , d P E L , C U S L : 0.1 to 50.0
- E.g.) AL1 alarm operation [A L - 1]: A n 3 A ,
AL1 alarm operation [A L 1]: 10°C,
Alarm output hysteresis [A H Y S]: 4

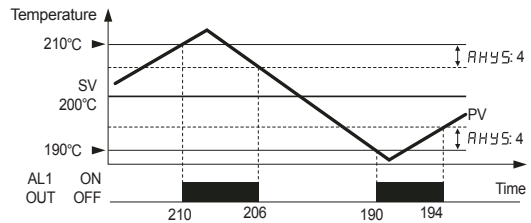

◎ Control output MV when input sensor line is broken [E r . n u]

When input sensor line is broken or setting value error occurs, this function is to set control output. You can set ON/OFF setting for ON/OFF control, MV setting for PID control.

◎ Error

Display	Description	Troubleshooting
o P E n	Flashes if input sensor is disconnected or sensor is not connected.	Check input sensor state.
H H H H	Flashes if measured sensor input is higher than temperature range.	When input is within the rated temperature range, this display disappears.
L L L L	Flashes if measured sensor input is lower than temperature range.	

Economical Dual Display Type, PID Control

◎ Output connections

Refer to page H-142 for output.

● Application of relay output type

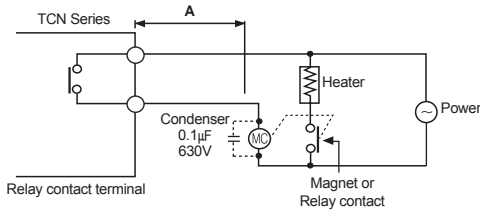

Keep **A** length as long as possible when wiring the temperature controller and the load. If wire length of **A** is short, counter electromotive force which occurs from a coil of magnet switch & power relay may flow in power line of the unit, and it may cause malfunction.

If wire length of **A** is short, please connect mylar condensers 104 (630V) on the both ends of "MC" (magnet coil) to protect electromotive force.

● Application of SSR drive output method

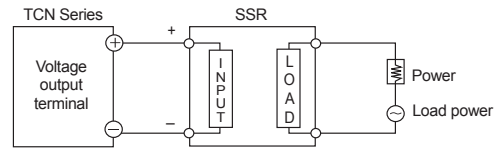

- ※SSR should be selected by the capacity of load, otherwise, it may short-circuit and result in a fire. Indirect heated should be used with SSR for efficient working.
- ※Please use a cooling plate or it may cause the capacity deterioration, breakdown of SSR for a long usage.
- ※Refer to page H-50 for phase/cycle control connections.

■ Proper Usage

◎ Simple "error" diagnosis

● When the load (Heater etc) is not operated

Please check operation of the OUT indicator located in front panel of the unit.

If the OUT indicator does not operate, please check the parameter of all programmed mode.

If indicator is operating, please check the output (Relay, SSR drive voltage) after separating output line from the unit.

● When it displays $\square PE n$ during operation

This is a warning that external sensor is open. Please turn off the power and check the wire state of the sensor. If sensor is not open disconnect sensor line from the unit and short the input +, - terminal. Turn on the power of the unit and check the controller displays room temperature.

If this unit cannot display room temperature, this unit is broken. Please remove this unit and contact our service center. (When the input mode is thermocouple, it is available to display room temperature.)

◎ Caution during use

- The connection wire of this unit should be separated from the power line and high voltage line in order to prevent from inductive noise.
- For crimp terminal, select following shaped terminal (M3)

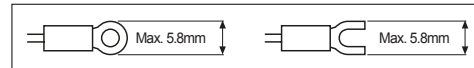

- Please install power switch or circuit-breaker in order to cut power supply off.
- The switch or circuit-breaker should be installed near by users.
- This unit is designed for temperature controlling only. Do not apply this unit as a voltage meter or a current meter.
- In case of using RTD sensor, 3-wire type must be used. If you need to extend the line, 3-wire must be used with the same thickness as the line. It might cause temperature difference if the resistance of line is different.
- In case of making power line and input signal line close, line filter for noise protection should be installed at power line and input signal line should be shielded.
- Keep away from the high frequency instruments. (High frequency welding machine & sewing machine, big capacitive SCR controller)
- When supplying measured input, if $HHHH$ or $LLLL$ is displayed, measured input may have problem. Turn off the power and check the line.
- This unit may be used in the following environments.
 - Indoor
 - Altitude: Under 2,000m
 - Pollution degree 2
 - Installation category II

(A) Photoelectric Sensors

(B) Fiber Optic Sensors

(C) Door/Area Sensors

(D) Proximity Sensors

(E) Pressure Sensors

(F) Rotary Encoders

(G) Connectors/Sockets

(H) Temperature Controllers

(I) SSRs / Power Controllers

(J) Counters

(K) Timers

(L) Panel Meters

(M) Tacho / Speed / Pulse Meters

(N) Display Units

(O) Sensor Controllers

(P) Switching Mode Power Supplies

(Q) Stepper Motors & Drivers & Controllers

(R) Graphic/Logic Panels

(S) Field Network Devices

(T) Software