

ISTRUZIONI MANUAL



WARNING!!

- Read carefully the user manual before installing and operating the product.
- This equipment must be installed by qualified personnel, complying with current standards to avoid damages or safety hazards

- Remove power before any intervention.
- The manufacturer assumes no responsibility for electrical safety in case of improper use of the device.
- Products illustrated herein are subject to alterations and changes without prior notice. Technical data and descriptions in the documentation are accurate to the best of our knowledge, but no liabilities for errors, omissions, or contingencies
- A circuit breaker must be included in the electrical installation of the building. It must be installed close by the equipment and within easy reach of the operator.

Table of Contents

Chapter 0	Preface	0-1
	0.1 Preface	0-1
Chapter 1	Safety Precautions	1-1
	1.1 Before Power UP	1-1
	1.2 During Power UP	1-2
	1.3 Before Operation	1-2
	1.4 During Operation	1-3
	1.5 During Maintenance	1-3
Chapter 2	Definition of Model	2-1
	2.1 Model	2-1
	2.2 Standard Product Specification	2-1
Chapter 3	Ambient Environment and Installation	3-1
	3.1 Environment	3-1
	3.2 Installation space	3-2
	3.2.1 Installation	3-2
	3.2.2 Installation space	3-4
	3.2.3 Dual-rating curve	3-5
	3.3 Wiring guidelines	3-6
	3.3.1 Power cables	3-6
	3.3.2 Control cable selection and wiring	3-6
	3.3.3 Wiring and EMC guidelines	3-7
	3.3.4 Failure liability	3-8
	3.3.5 Considerations for peripheral equipment	3-9
	3.3.6 Ground connection	3-10
	3.3.7 Inverter exterior	3-10
	3.4 Product Specifications	3-11
	3.4.1 Product Specifications	3-11
	3.4.2 General Specifications	3-12
	3.5 Standard wiring	3-13
	3.5.1 Single phase(PNP input)	3-13
	3.6 Terminal Description	3-14
	3.6.1 Description of main circuit terminals	3-14
	3.6.2 Control circuit terminal description	3-14
	3.7 Outline Dimensions	3-15
	3.8 EMC filter link to earth	3-16
Chapter 4	Software Index	4-1
	4.1 Keypad Description	4-1
	4.1.1 Operator Panel Functions	4-1
	4.1.2 Digital Display Description	4-2
	4.1.3 Digital Display Setup	4-4
	4.1.4 Keypad Operation Example	4-6
	4.1.5 Operation Control	4-8
	4.2 Programmable Parameter Groups	4-9

	4.3 Parameter Function Description	4-22
Chapter 5	Troubleshooting and Maintenance	5-1
	5.1 Error Display and Corrective Action	5-1
	5.1.1 Manual Reset and Auto-Reset	5-1
	5.1.2 Keypad Operation Error Instruction	5-2
	5.1.3 Special conditions	5-3
	5.2 General troubleshooting	5-4
	5.3 Troubleshooting of INV	5-5
	5.3.1 Quick troubleshooting of INV	5-5
	5.3.2 Troubleshooting for OC, OL error displays	5-7
	5.3.3 Troubleshooting for OV, LV error	5-8
	5.3.4 Motor not running	5-9
	5.3.5 Motor Overheating	5-10
	5.3.6 Motor runs unbalanced	5-11
	5.4 Routine and periodic inspection	5-11
	5.5 Maintenance	5-13
Chapter 6	Peripheral Components	6-1
	6.1 Reactor Specifications	6-1
	6.2 Electromagnetic Contactor and No fuse circuit breaker	6-1
	6.3 Fuse Specification	6-1
	6.4 Fuse Specification(UL Model Recommended)	6-1
Appendix I	Parameters Setting List	App1-1

Chapter 0 Preface

0.1 Preface

To extend the performance of the product and ensure personnel safety, please read this manual thoroughly before using the inverter. Should there be any problem in using the product that cannot be solved with the information provided in the manual, contact our technical or sales representative who will be willing to help you.

※Precautions

The inverter is an electrical product. For your safety, there are symbols such as “Danger”, “Caution” in this manual as a reminder to pay attention to safety instructions on handling, installing, operating, and checking the inverter. Be sure to follow the instructions for highest safety.



Danger

Indicates a potential hazard that could cause death or serious personal injury if misused.



Caution

Indicates that the inverter or the mechanical system might be damaged if misused.

Danger

- Risk of electric shock. The DC link capacitors remain charged for five minutes after power has been removed. It is not permissible to open the equipment until 5 minutes after the power has been removed.
- Do not make any connections when the inverter is powered on. Do not check parts and signals on circuit boards during the inverter operation.
- Do not disassemble the inverter or modify any internal wires, circuits, or parts.
- Ensure that the Inverter Ground terminal is connected correctly.

Caution

- Do not perform a voltage test on parts inside the inverter. High voltage can destroy the semiconductor components.
- Do not connect T1, T2, and T3 terminals of the inverter to any AC input power supply.
- CMOS ICs on the inverter’s main board are susceptible to static electricity. Do not touch the main circuit board.

Chapter 1 Safety Precautions

1.1 Before Power Up

Danger

- Make sure the main circuit connections are correct. Single phase L1, L2 are power-input terminals and must not be mistaken for T1, T2 and T3. Otherwise, inverter damage can result.

Caution

- The line voltage applied must comply with the inverter's specified input voltage. (See the nameplate)
- To avoid the front cover from disengaging, or other damage do not carry the inverter by its covers. Support the drive by the heat sink when transporting. Improper handling can damage the inverter or injure personnel and should be avoided.
- To avoid the risk of fire, do not install the inverter on a flammable object. Install on nonflammable objects such as metal.
- If several inverters are placed in the same control panel, provide heat removal means to maintain the temperature below 50 degree C to avoid overheat or fire.
- When disconnecting the remote keypad, turn the power off first to avoid any damage to the keypad or the inverter.

Warning

- This product is sold subject to EN 61800-3 and EN 61800-5-1. In a domestic environment this product may cause radio interference in which case the user may be required to apply corrective measures.

Caution

- Work on the device/system by unqualified personnel or failure to comply with warnings can result in severe personal injury or serious damage to material. Only suitably qualified personnel trained in the setup, installation, commissioning and operation of the product should carry out work on the device/system.
- Only permanently-wired input power connections are allowed.

1.2 During Power Up

Danger

- When the momentary power loss is longer than 2 seconds, the inverter will not have sufficient stored power for its control circuit. Therefore, when the power is re-applied, the run operation of the inverter will be based on the setup of following parameters:
 - Run parameters. 00-02 or 00-03.
 - Direct run on power up. Parameter. 07-04 and the status of external run switch,

Note- the start operation will be regardless of the settings for parameters 07-00/07-01/07-02.

Danger. Direct run on power up.

If direct run on power up is enabled and inverter is set to external run with the run FWD/REV switch closed then the inverter will restart.

Danger

Prior to use, ensure that all risks and safety implications are considered.

- When the momentary power loss ride through is selected and the power loss is short, the inverter will have sufficient stored power for its control circuits to function, therefore, when the power is resumed the inverter will automatically restart depending on the setup of parameters 07-00 & &- 7-01.

1.3 Before Operation

Caution

- Make sure the model and inverter capacity are the same as that set in parameter 13-00.

Note : On power up the supply voltage set in parameter 01-01 will flash on the display for 2 seconds.

1.4 During Operation

Danger

- Do not connect or disconnect the motor during operation. Otherwise, It may cause the inverter to trip or damage the unit.

Danger

- To avoid electric shock, do not take the front cover off while power is on.
- The motor will restart automatically after stop when auto-restart function is enabled. In this case, care must be taken while working around the drive and associated equipment .
- The operation of the stop switch is different than that of the emergency stop switch. The stop switch has to be activated to be effective. Emergency stop has to be de-activated to become effective.

Caution

- Do not touch heat radiating components such as heat sinks and brake resistors.
- The inverter can drive the motor from low speed to high speed. Verify the allowable speed ranges of the motor and the associated machinery.
- Note the settings related to the braking unit.
- Risk of electric shock. The DC link capacitors remain charged for five minutes after power has been removed. It is not permissible to open the equipment until 5 minutes after the power has been removed.

Caution

- The Inverter should be used in environments with temperature range from (14-104°F) or (-10 to 40°C) and relative humidity of 95%.

Danger

- Make sure that the power is switched off before disassembling or checking any components.

1.5 Inverter Disposal

Caution

Please dispose of this unit with care as an industrial waste and according to your required local regulations.

- The capacitors of inverter main circuit and printed circuit board are considered as hazardous waste and must not be burnt.
- The Plastic enclosure and parts of the inverter such as the cover board will release harmful gases if burnt.

Chapter 2 Part Number Definition

2.1 Model Code

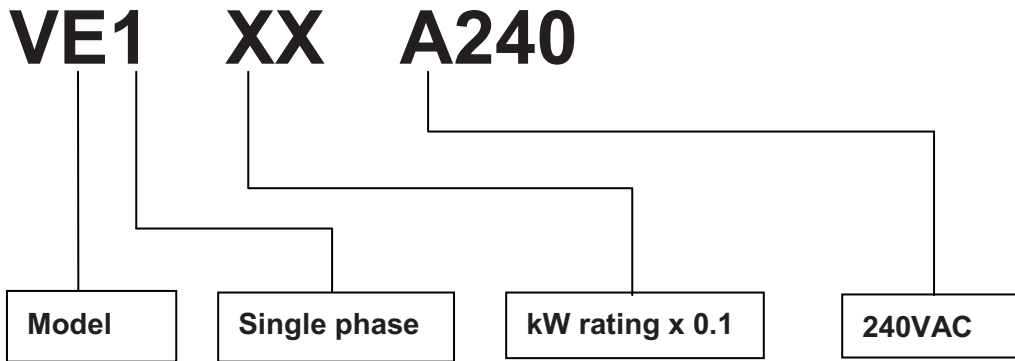

2.2 Standard Product Specification

Model	Supply Voltage (Vac)	Frequency (Hz)	(KW)
VE1 02 A240	1ph, 200~240V +10% / -15%	50/60Hz	0.2
VE1 04 A240			0.4
VE1 07 A240			0.75
VE1 15 A240			1.5
VE1 22 A240			2.2

Chapter 3 Environment & Installation

3.1 Environment

Installation environment has a direct affect on the correct operation and the life expectancy of the inverter. Install the inverter in an environment complying with the following conditions:

Protection	
Protection class	IP20
Suitable environment	
Operating temperature	-10~40℃ (-10~50℃ with fan) If several inverters are installed in the same control panel, ensure adequate spacing and provide the necessary cooling and ventilation for successful operation.
Storage temperature	-20~60℃
Relative Humidity	Max 95% (without condensation) No frost.
Shock	1g (9.8m/s ²) for 20Hz and below. 0.6g (5.88m/s ²) from 20Hz to 50Hz

Installation site

Install in an environment that will not have an adverse effect on the operation of the unit and ensure that there is no exposure to areas such as that listed below:-

- Direct sunlight, Rain or moisture
- Oil mist and salt
- Dust, lint fibbers, small metal filings and corrosive liquid and gas
- Electromagnetic interference from sources such as welding equipment
- Radioactive and flammable materials
- Excessive vibration from machines such as stamping, punching machines
- Add a vibration-proof pads if necessary

3.1 Tightening torque for terminals

Chart 3-1

Model	TM1			TM2		
	Cable Size mm ²	Tightening torque		Cable Size mm ²	Tightening torque	
		kgf.cm	Nm		kgf.cm	Nm
Frame1	0.34~6	14	1.37	0.25~4	4.08	0.4
Frame2		12.24	1.2			

3.2 Installation

3.2.1 Installation methods

Frame1. Mounting on a flat surface.

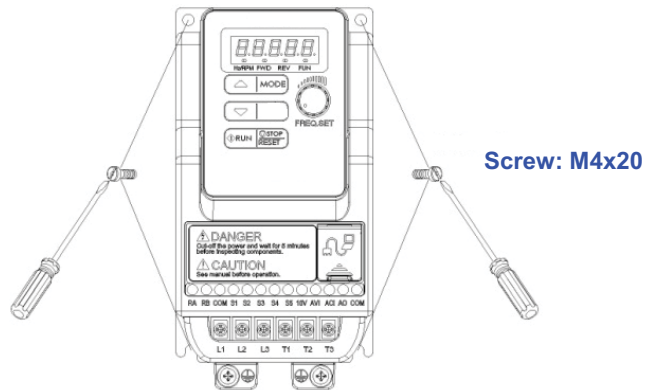

Din rail type installation:

Din rail kit includes a plastic and a metal adaptor plates.

Assembly Steps:-

- 1) Attach the metal adaptor plate to the inverter base with the screws provided.
- 2) Attach the plastic Din rail adaptor to the metal adaptor plate.
- 3) Push the plastic adaptor forward to lock into position.

Disassembly Steps:-

- 1) Unlock by pushing the snap hooks
- 2) Retract and remove the plastic Din rail adaptor.
- 3) Unscrew the metal plate & Remove

Assembly:-

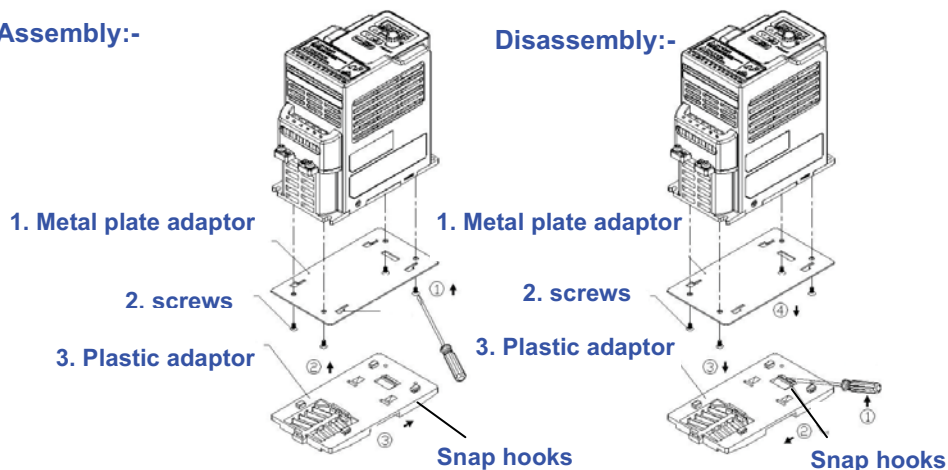

Frame 2. Mounting on a flat surface.

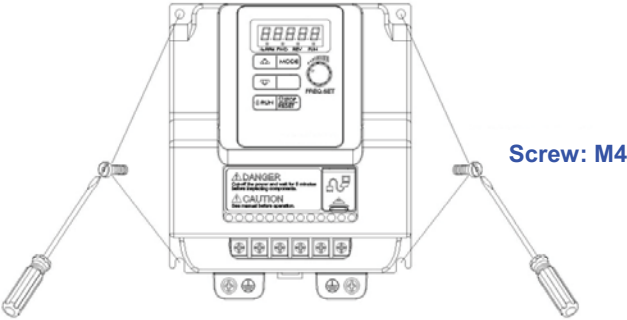

Din rail type installation:

Din rail kit includes a plastic adaptor plate as an attachment for the inverter base. Refer to Diagram below:-

Assembly:-

Disassembly:-

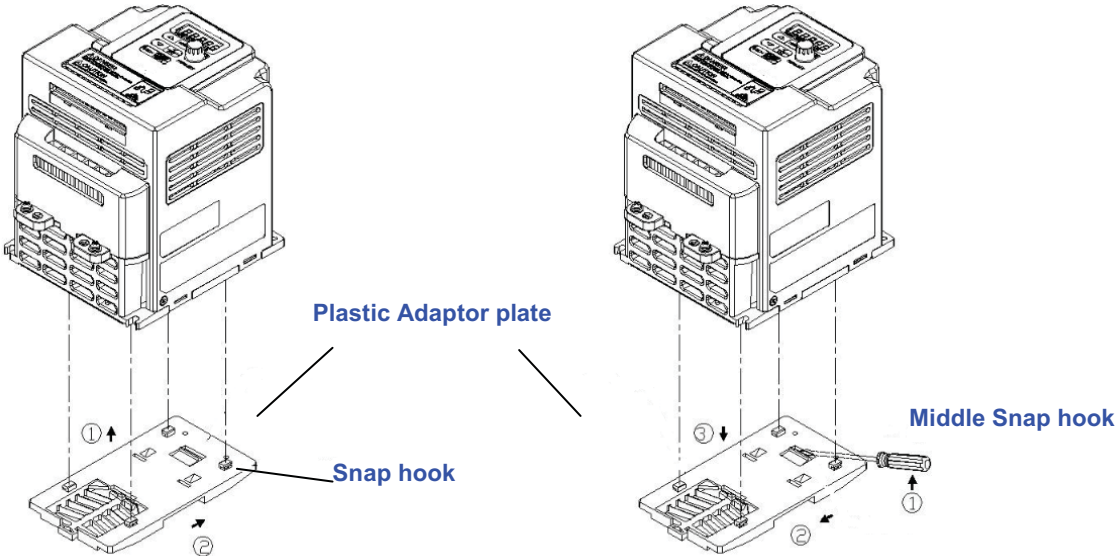

Din Rail Mounting & Dismounting as shown in the diagram below:-Use a 35mm Din Rail.

Mounting

Dismounting

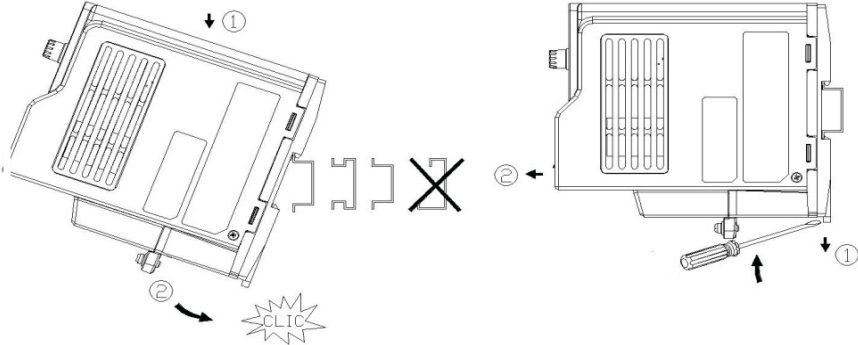

3.2.2 Installation space

Provide sufficient air circulation space for cooling as shown in examples below. Install the Inverter on surfaces that provide good heat dissipation.

Single unit Installation

Install the inverter vertically to obtain effective cooling.

Frames 1 & 2.

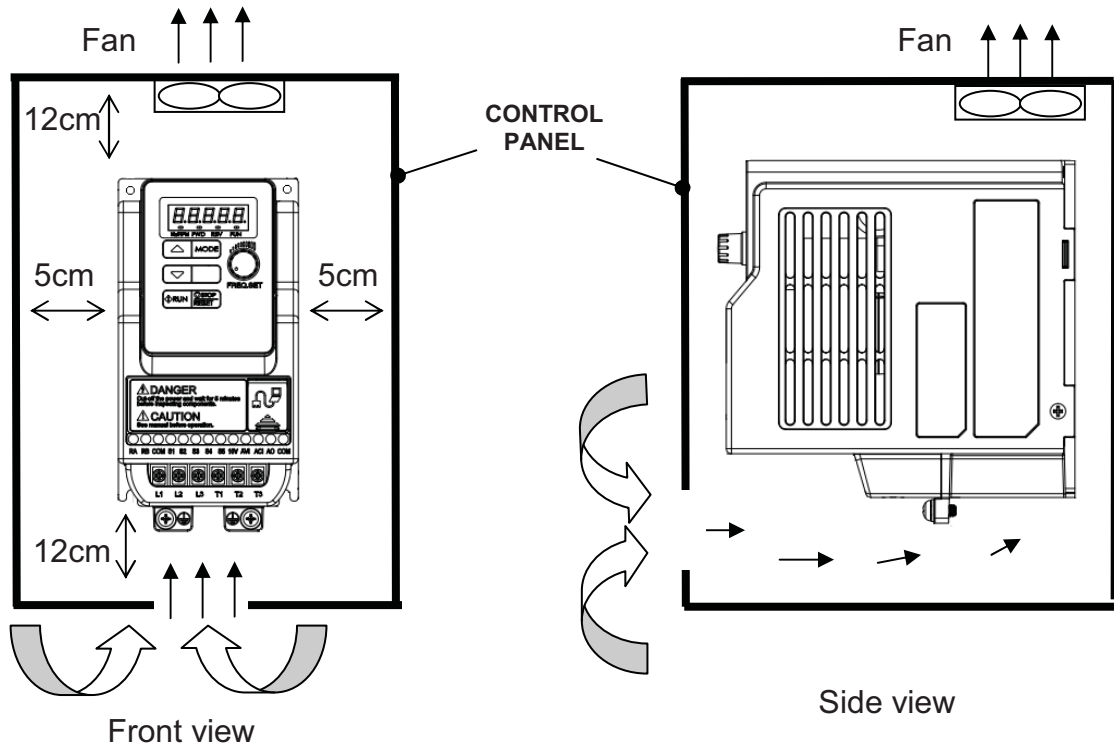

Multiple Installation

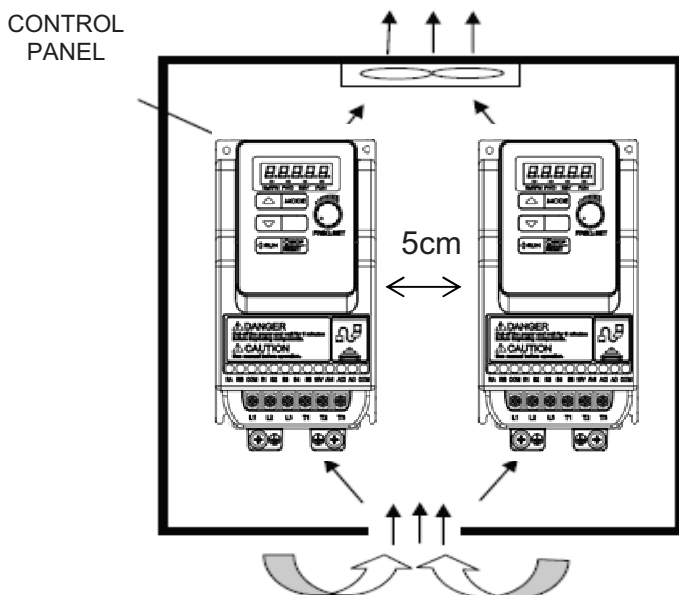

Provide the necessary physical space and cooling based on the ambient temperature and the heat loss in the panel

3.2.3 De-rating curve

Curves below show the applicable output current de-rate due to setting of carrier frequency and the ambient operating temperatures of 40 and 50 degree C.

Frame 1

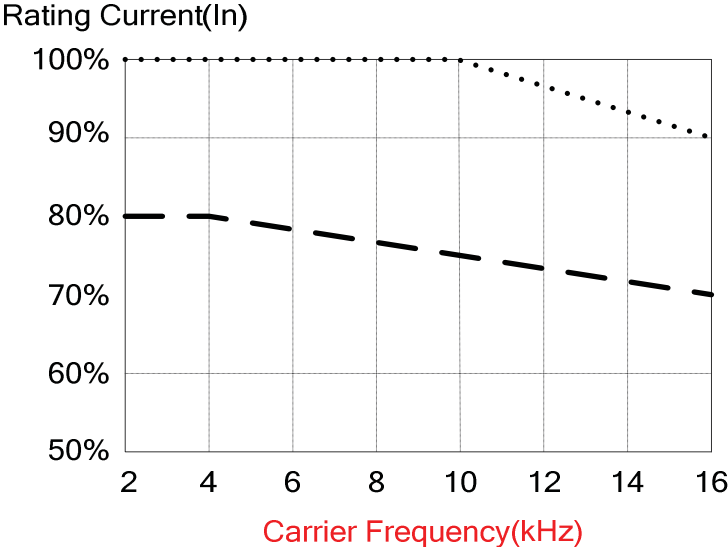

Note:

- De-rate curve of ambient temperature 40 degree C.
- - - De-rate curve of ambient temperature 50 degree C.

Frame 2. De-rating is not required.

3.3 Wiring Guidelines

3.3.1 Power Cables.

Supply power cable must be connected to TM1 terminal block, terminals L1 and L2(N). Neutral cable must be connected at L2(N). Motor cable must be connected to TM1 terminals. T1, T2, T3.

Warning:- Connection of Supply line cable to terminals T1,T2& T3 will result in serious damage to the drive components.

Example power connections: Inverter with dedicated power line.

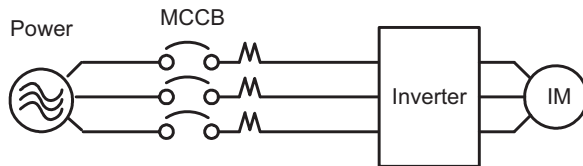

- Install a Supply RFI filter or Isolation transformer when the power source is shared with other high power electrical equipment as shown below.

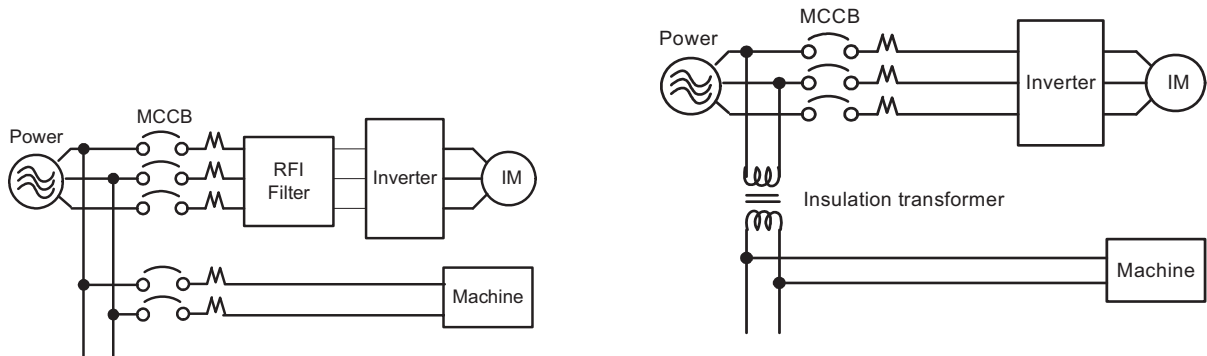

3.3.2 Control Cable selection and Wiring.

Control cables should be connected to terminal block TM2.

Choose power & Control cables according to the following criteria:-

- Use copper wires with correct diameter and temperature rating of 60/75°C.
- Minimum cable voltage rating for 200V type inverters should be 300VAC.
- Route all cables away from other high voltage or high current power lines to reduce interference effects.

Use a twisted pair shielded cable and connect the shield (screen) wire to the ground terminal at the inverter end only. Cable length should not exceed 50 meters.

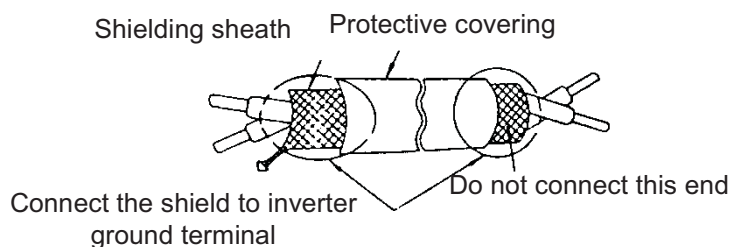

3.3.3 Wiring and EMC guidelines.

For effective interference suppression, do not route power and control cables in the same conduit or trucking.

To prevent radiated noise, motor cable should be put in a metal conduit. Alternatively an armored or shielded type motor cable should be used.

For effective suppression of noise emissions the cable armor or shield must be grounded at both ends to the motor and the inverter ground. These connections should be as short as possible.

Motor cable and signal lines of other control equipment should be at the least 30 cm apart.

VE1 has a built in Class "A" EMC filter to first Environment Restricted. (Category C2). For some installations such as residential,(Category C1) an optional external Class "B" type filter will be necessary. Please consult your local supplier.

Typical Wiring.

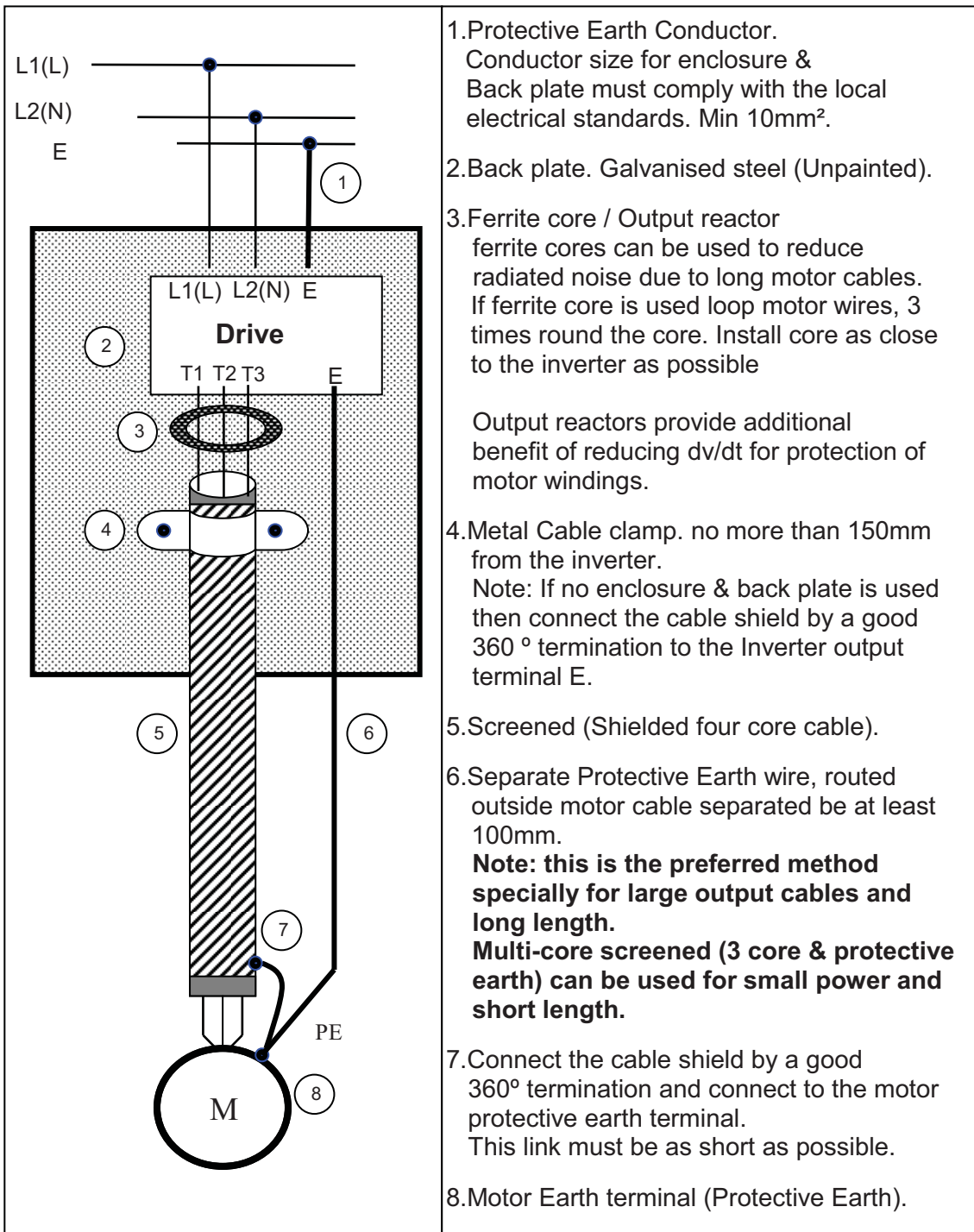

1. Protective Earth Conductor.
Conductor size for enclosure & Back plate must comply with the local electrical standards. Min 10mm².
2. Back plate. Galvanised steel (Unpainted).
3. Ferrite core / Output reactor
ferrite cores can be used to reduce radiated noise due to long motor cables. If ferrite core is used loop motor wires, 3 times round the core. Install core as close to the inverter as possible

Output reactors provide additional benefit of reducing dv/dt for protection of motor windings.
4. Metal Cable clamp. no more than 150mm from the inverter.
Note: If no enclosure & back plate is used then connect the cable shield by a good 360 ° termination to the Inverter output terminal E.
5. Screened (Shielded four core cable).
6. Separate Protective Earth wire, routed outside motor cable separated be at least 100mm.
Note: this is the preferred method specially for large output cables and long length.
Multi-core screened (3 core & protective earth) can be used for small power and short length.
7. Connect the cable shield by a good 360° termination and connect to the motor protective earth terminal.
This link must be as short as possible.
8. Motor Earth terminal (Protective Earth).

3.3.4 Failure liability.

- Lovato Electric bears no responsibility for any failures or damaged caused to the inverter if the recommendations in this instruction manual have not been followed specifically points listed below,
- If a correctly rated fuse or Circuit breaker has not been installed between the power source and the inverter.
- If a magnetic contactor, a phase capacitor, burst absorber and LC or RC circuits have been connected between the inverter and the motor.
- If an incorrectly rated three-phase induction motor has been used.

Note:

When one inverter is driving several motors, the total current of all motors running simultaneously must be less than the rated current of the inverter, and each motor has to be equipped with a correctly rated thermal overload relay.

3.3.5 Considerations for peripheral equipment

	<p>Power</p>	<p>Ensure that the supply voltage is correct. A molded-case circuit breaker or fused disconnect must be installed between the AC source and the inverter</p>
<p>Circuit Breaker & RCD</p>	<p>Use a molded-case circuit breaker that conforms to the rated voltage and current of the inverter. Do not use the circuit breaker as the run/stop switch for the inverter. Residual Current Circuit Breaker (RCD): A suitably rated type “B” RCD should be used according to the local electrical standards.</p>	
<p>Magnetic contactor</p>	<p>Normally a magnetic contactor is not needed. A contactor can be used to perform functions such as external control and auto restart after power failure. Do not use the magnetic contactor as the run/stop switch for the inverter.</p>	
<p>AC reactor for power quality improvement</p>	<p>When a 200V/400V inverter with rating below 15KW is connected to a high capacity power source (600KVA or above) then an AC reactor can be connected for power factor improvement and reducing harmonics.</p>	
<p>Input noise filter</p>	<p>VE1 inverter has a built-in filter to Class “A” first Environment. (Category C2) To satisfy the required EMC regulations for your specific application you may require an additional EMC filter.</p>	
<p>Inverter</p>	<p>Connect the single phase power to Terminals, L1(L) & L2(N). Warning! Connecting the input terminals T1, T2, and T3 to AC input power will damage the inverter. Output terminals T1, T2, and T3 are connected to U, V, and W terminals of the motor. To reverse the motor rotation direction swap any two wires at terminals T1, T2, and T3. Ground the Inverter and motor correctly. Ground Resistance for 200V power < 100 Ohms.</p>	
<p>Motor</p>	<p>Three-phase induction motor. Voltage drop on motor due to long cable can be calculated. Volts drop should be < 10%. Phase-to-phase voltage drop (V) = $\sqrt{3} \times \text{resistance of wire } (\Omega/\text{km}) \times \text{length of line (m)} \times \text{current} \times 10^{-3}$</p>	

3.3.6 Ground connection

Inverter Ground terminal must be connected to installation ground correctly and according to the required local wiring standards.

- Ground cable size must be according to the required local wiring standards. Ground connection should be as short as possible.
- Do not share the ground of the inverter with other high current loads (Welding machine, high power motors). Ground each unit separately.
- Ensure that all ground terminals and connections are secure
- Do not make ground loops when several inverters share a common ground point.

Note: Please leave at least 5cm while installing inverter side by side in order to provide enough cooling space.

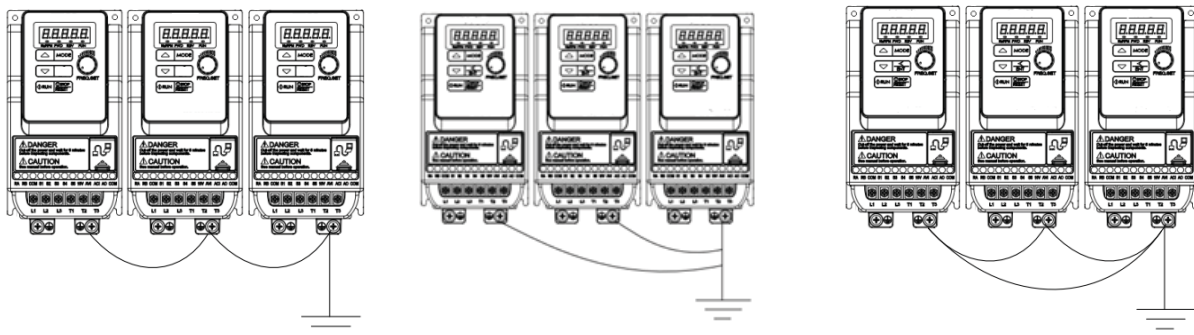

(a) Correct

(b) Correct

(c) Incorrect

3.3.7 Inverter exterior

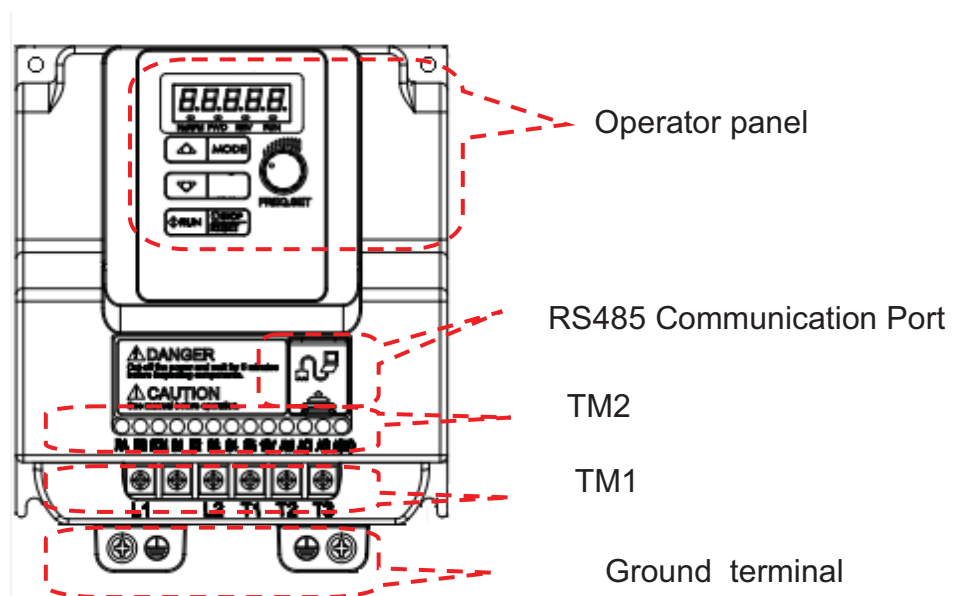

3.4 Specifications

3.4.1 Product Specifications

240V Class: Single phase.

Model:VE1...A240	02	04	07	15	22
Suitable motor capacity (KW)	0.2	0.4	0.75	1.5	2.2
Rated output current (A)	1.8	2.6	4.3	7.5	10.5
Rated capacity (KVA)	0.68	1.00	1.65	2.90	4.00
Input voltage range(V)	Single Phase : 200~240V,50/60HZ				
Allowable voltage fluctuation	+10%-15%				
Output voltage range(V)	Three phase 0~240V				
Input current (A)	4.9	7.2	11	15.5	21
Allowable momentary power loss time (S)	1.0	1.0	1.0	2.0	2.0
Enclosure	IP20				

*The input current is calculated value at full rated output current.

3.4.2 General Specifications

Item		VE1
Control Mode		V/F Control + Auto-torque compensation function
Frequency	Range	0.01~650.00Hz
	Setting resolution	Digital input : 0.01Hz
		Analog input : 0.06Hz/60Hz
	Setting	Keypad : Set directly with ▲ ▼ keys or the VR (Potentiometer) on the keypad
		External Input Terminals: AVI(0/2~10V), ACI(0/4~20mA)input Multifunction input up/down function(Group3) Setting frequency by communication method.
Frequency limit	Lower and upper frequency limits 3 -skip frequency settings.	
Run	Operation set	Keypad run, stop button
		External terminals: Multi- operation-mode 2 / 3 wire selection Jog operation
		Run signal by communication method.
Main Control Functions	V / F curve setting	6 fixed curve, One programmable.
	Carrier frequency	1~16KHz(default 5KHz)
	Acceleration and deceleration control	2 off Acc / dec time parameters. 4 off S curve parameters.
	Multifunction input	19 functions (refer to description on group3)
	Multifunction output	14 functions (refer to description on group3)
	Multifunction analog output	5 functions (refer to description on group3)
	Main features	Overload Detection, 8 preset speeds, Auto-run, Acc/Dec Switch (2 Stages), Main/Alt run Command select, Main/Alt Frequency Command select, PID control, torque boost, V/F start Frequency ,Fault reset.
Display	LED	Display: parameter/parameter value/frequency/line speed/DC voltage/output voltage/output current/PID feedback/input and output terminal status/Heat sink temperature/Program Version/Fault Log.
	LED Status Indicator	For run/stop/forward and reverse.
Protective Functions	Overload Protection	Integrated motor and Inverter overload protection.
	Over voltage	Over 410V
	Under voltage	Under 190V
	Momentary Power Loss Restart	Inverter auto-restart after a momentary power loss.
	Stall Prevention	Stall prevention for Acceleration/ Deceleration/ and continuous Run.
	Short-circuit output terminal	Electronic Circuit Protection
	Grounding Fault	Electronic Circuit Protection

3.5 Standard wiring

3.5.1 Single phase (PNP):

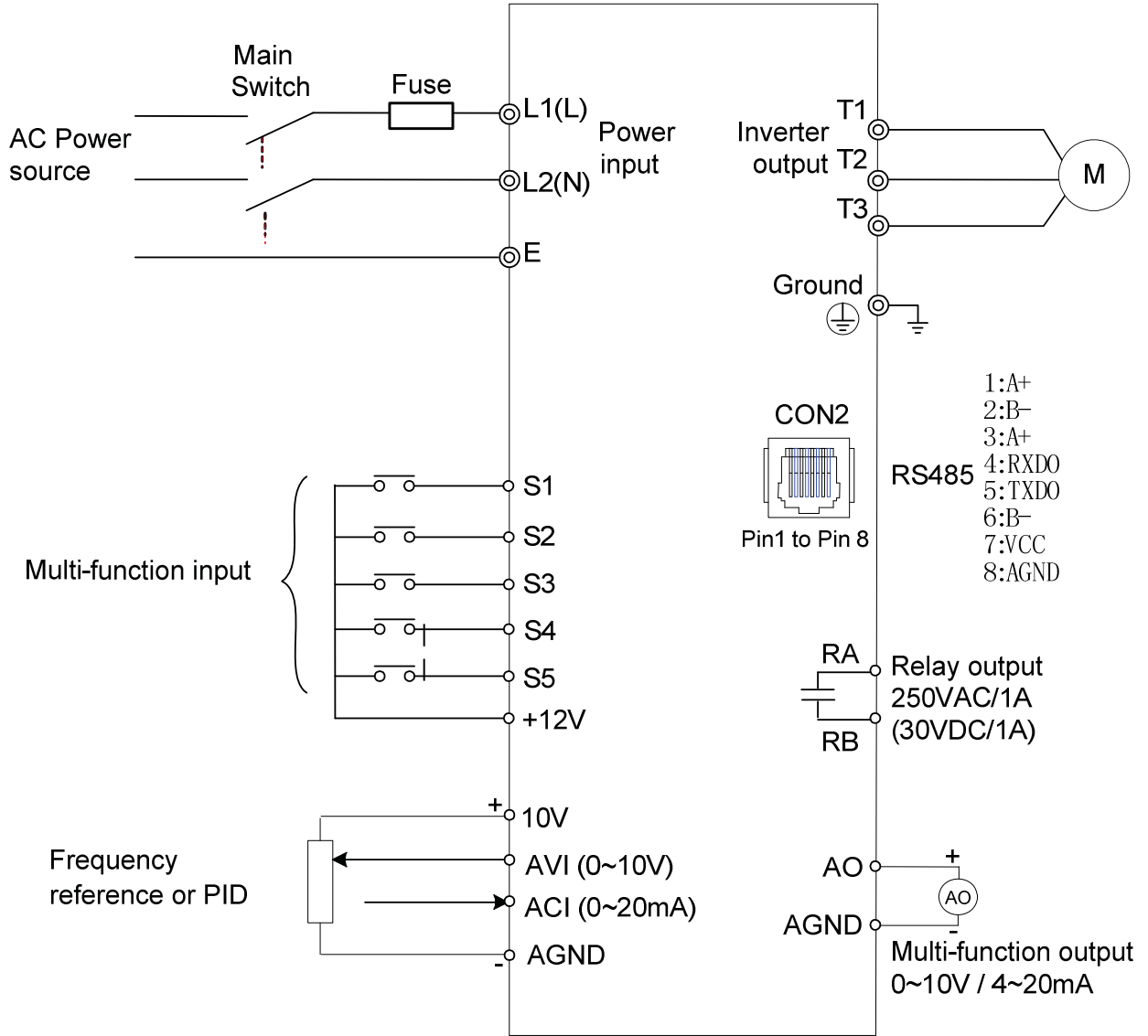

Model: VE1 02 A240 / VE1 04 A240 / VE1 07 240 / VE1 15 A240 / VE1 22 A240

3.6 Terminal Description

3.6.1 Description of main circuit terminals

Terminal symbols	TM1 Function Description
L1(L)	Main power input, L1(L)/L2(N)
L2(N)	
T1	Inverter output, connect to U, V, W terminals of motor
T2	
T3	
	Ground terminal

Single phase

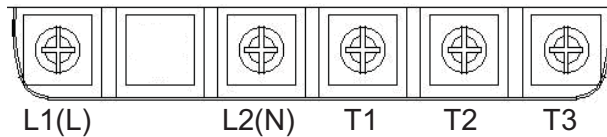

3.6.2 Control circuit terminal description

Terminal symbols	TM1 Function Description
RA	Relay output terminal, Specification: 250VAC/1A(30VDC/1A)
RB	
+12V	S1~S5 (COMMON) 【PNP】
S1	Multi-function input terminals(refer to group3) Built in Power for an external speed potentiometer
S2	
S3	
S4	
S5	
10V	
AVI	Analog voltage input, Specification : 0~10VDC/ 2-10V
ACI	Analog current input, Specification : 0/4~20mA
AO	Multi function analog output terminal. Maximum output 10VDC/1mA
AGND	Analog ground terminal

PNP:

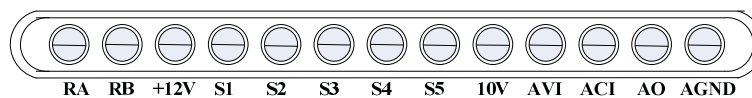

3.7 Outline Dimensions (unit: mm)

Frame1

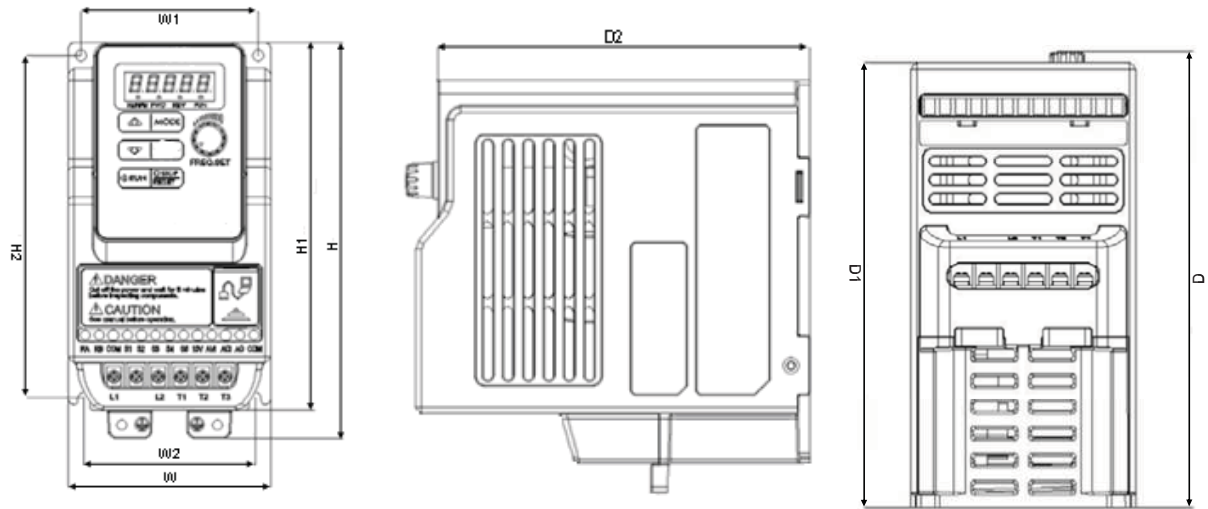

Unit : mm(inch)

Model	W	W1	W2	H	H1	H2	D	D1	Weight
VE1 02 A240	72	63	61	141	131	122	139.2	136	0.9 Kg
VE1 04 A240									
VE1 07 A240									

Frame2

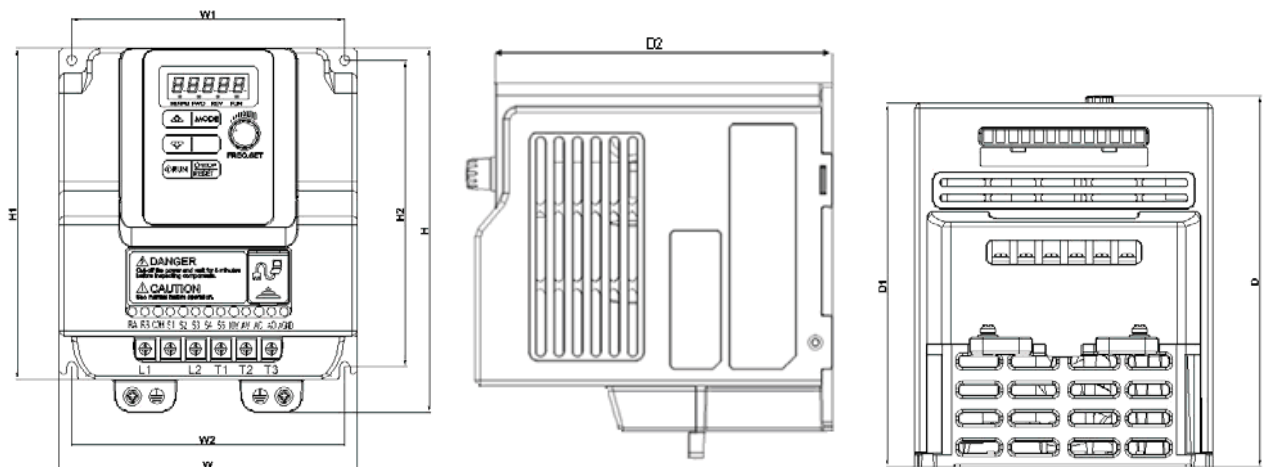

Unit : mm(inch)

Model	W	W1	W2	H	H1	H2	D	D1	Weight
VE1 15 A240	118	108	108	144	131	121	147.3	144.2	1.6Kg
VE1 22 A240									

3.8 EMC Filter Disconnection

EMC filter may be disconnected:

Inverter drives with built-in EMC filter are not suitable for connection to certain type of supply systems, such as listed below; in these cases the RFI filter can be disabled.

In all such cases consult your local electrical standards requirements.

IT type supply systems (ungrounded) & certain supply systems for medical equipment.

For ungrounded supply systems If the filter is not disconnected the supply system becomes connected to Earth through the Y capacitors on the filter circuit. This could result in danger and damage to the Drive.

Disconnection steps :

1. Remove EMC filter protection cover by screwdriver.
2. Remove EMC line by pliers.

Note:- Disconnecting the EMC filter link will disable the filter function, please consult your local EMC standards requirement..

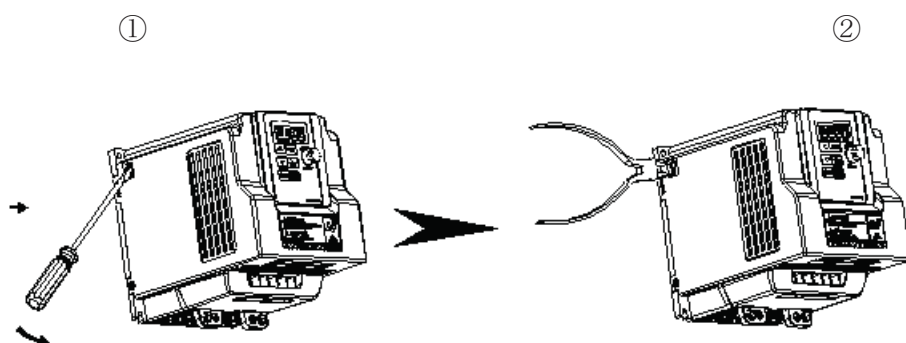

Chapter4 Software Index

4.1 Keypad Description

4.1.1 Operator Panel Functions

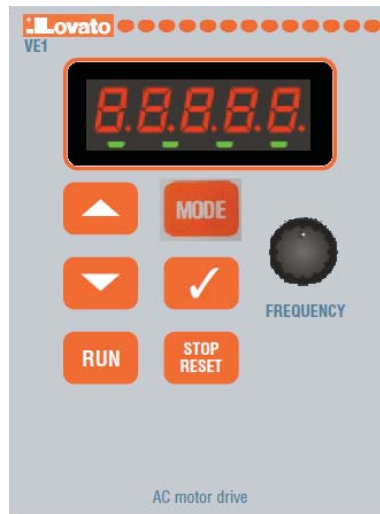

Type	Item	Function
Digital display & LEDs	Main digital displays	Frequency Display, Parameter, voltage, Current, Temperature, Fault messages.
	LED Status	Hz/RPM: ON when the frequency or line speed is displayed. OFF when the parameters are displayed. FWD: ON while the inverter is running forward. Flashes while stopped. REV: ON while the inverter is running reverse. Flashes while stopped. FUN: ON when the parameters are displayed. OFF when the frequency is displayed.
Variable Resistor	FREQ SET	Used to set the frequency
Keys On Keypad	RUN	RUN: Run at the set frequency.
	STOP/RESET (Dual function keys)	STOP: Decelerate or Coast to Stop. RESET: Use to Reset alarms or resettable faults.
	▲	Increment parameter number and preset values.
	▼	Decrement parameter number and preset values.
	MODE	Switch between available displays
	√ (Dual function keys, a short press for left shift function, a long press for ENTER function)	1. Left Shift: Used while changing the parameters or parameter values 2. ENTER: Used to display the preset value of parameters and for saving the changed parameter values.

4.1.2 Digital display Description

Alpha numerical display format

Digit	LED	Letter	LED	Letter	LED	Symbol	LED
0		A		n		-	
1		b		o		°	
2		C		P		_	
3		d		q		.	
4		E		r			
5		F		S			
6		G		t			
7		H		u			
8		J		v			
9		L		Y			

Digital display indication formats

Actual output frequency	Set frequency	
Digits are lit Continually	Preset digits flashing	Selected digit flashing

LED display examples

Display	Description
	In stop mode shows the set frequency In run mode shows the actual output frequency
	Selected Parameter
	Parameter Value
	Output Voltage
	Output Current in Amps
	DC Bus voltage
	Temperature
	PID feedback value
	Error display
	Analogue Current / Voltage ACI / AVI . Range (0~1000)

LED Status description

		LED Indicator light Status		
Frequency / line speed Indicator	Hz/RPM	On		
Menu mode indicator	Fun	On while not displaying frequency or line speed		
FWD indicator	FWD	On while running forward		Flashing while stopped in Forward mode.
REV indicator light	REV	On while running reverse		Flashing while stopped in Reverse mode

4.1.3 Digital display set up

On power up digital display screens will be as shown below.

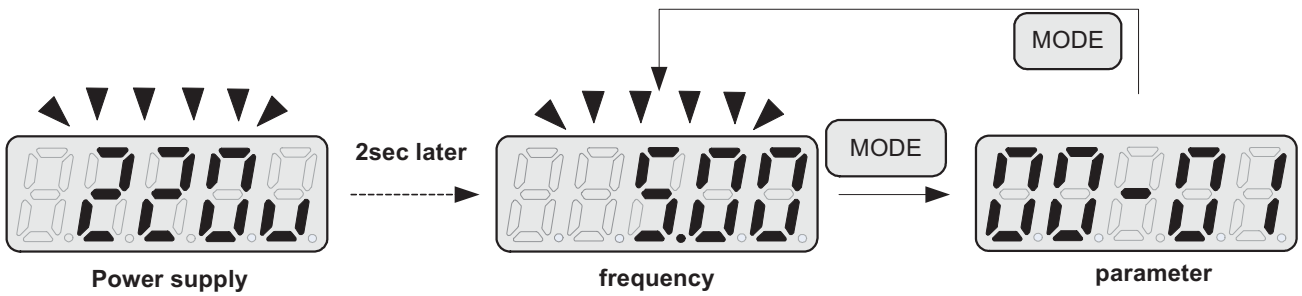

User selectable display formats:

12- 00	Display Mode								
	0 0 0 0 0								
	high Low								
	Each of the above 5 digits can be set to any of the selections below from 0 to 7								
Range	<table border="0"> <tr> <td>[0] :Disable display</td> <td>[1] :output Current</td> </tr> <tr> <td>[2] :output Voltage</td> <td>[3] :DC voltage</td> </tr> <tr> <td>[4] :Temperature</td> <td>[5] :PID feedback</td> </tr> <tr> <td>[6] :AVI</td> <td>[7] :ACI</td> </tr> </table>	[0] :Disable display	[1] :output Current	[2] :output Voltage	[3] :DC voltage	[4] :Temperature	[5] :PID feedback	[6] :AVI	[7] :ACI
[0] :Disable display	[1] :output Current								
[2] :output Voltage	[3] :DC voltage								
[4] :Temperature	[5] :PID feedback								
[6] :AVI	[7] :ACI								

The highest bit of 12-00 sets the power on the display, other bits set the selected display from range 0-7.as Listed above.

Example1: Set parameter 12- 00= [10000] to obtain display format shown below.

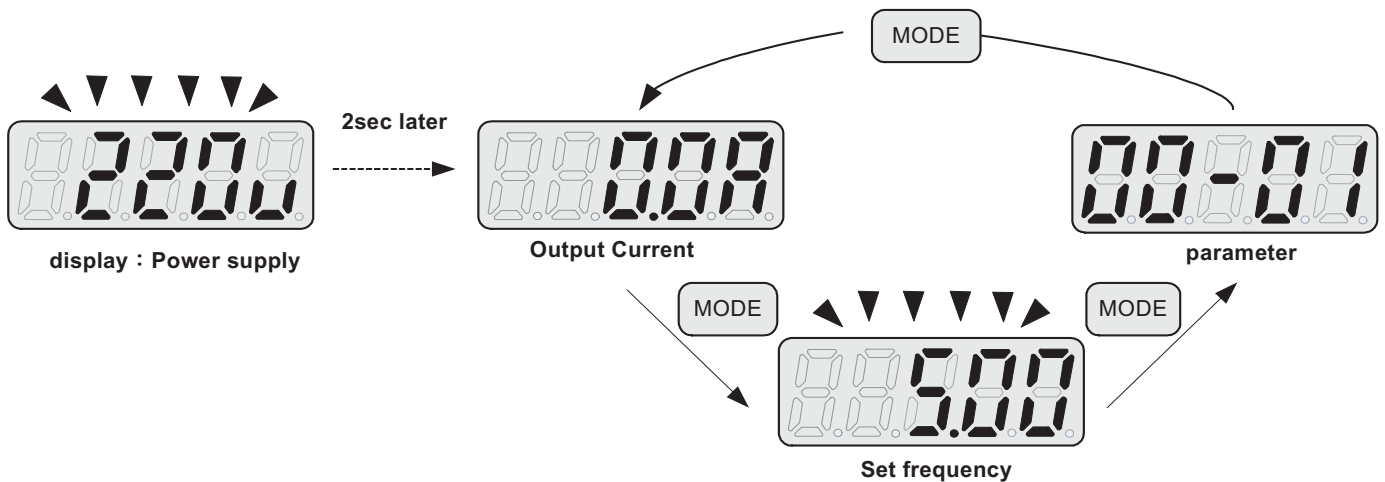

Example 2. Set parameter 2: 12- 00= [12345] to obtain the display format shown below.

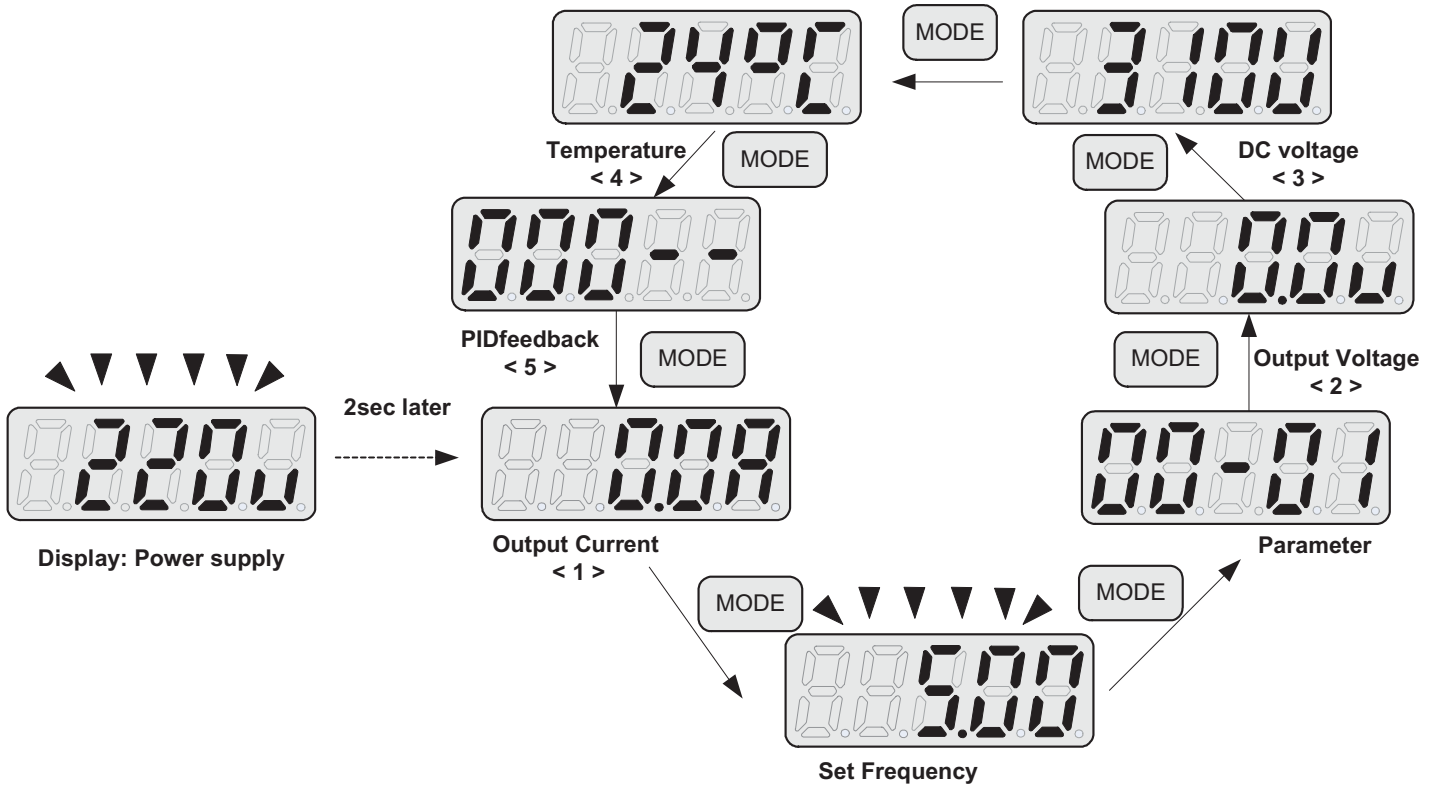

Increment/ Decrement key functions:

1. “▲”/ “▼” :

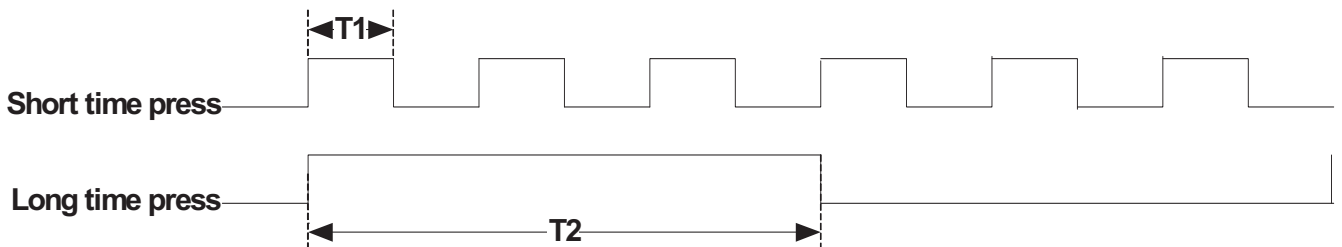

Quick pressing of these keys will Increment or Decrement the selected digit by one. Extended pressing will Increment or Decrement the selected digit continuously.

2. “</ENT” Key functions :

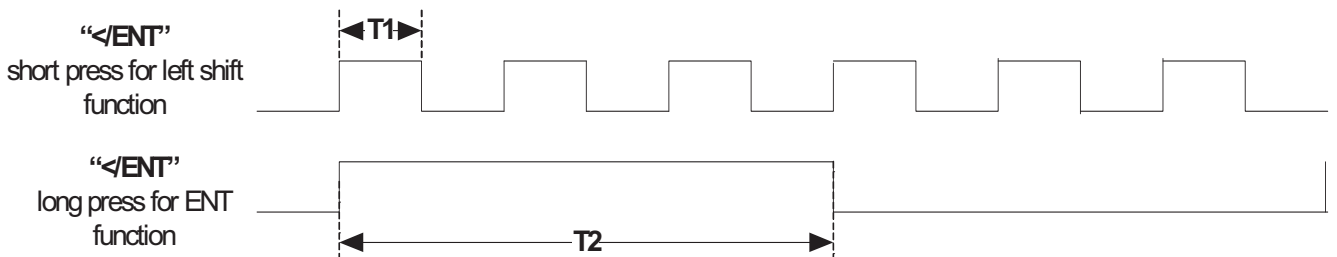

Quick pressing of this key will display the preset value of the parameter selected. Extended pressing of this key will save the altered value of the selected parameter.

4.1.4 Example of keypad operation

Example1: Modifying Parameters

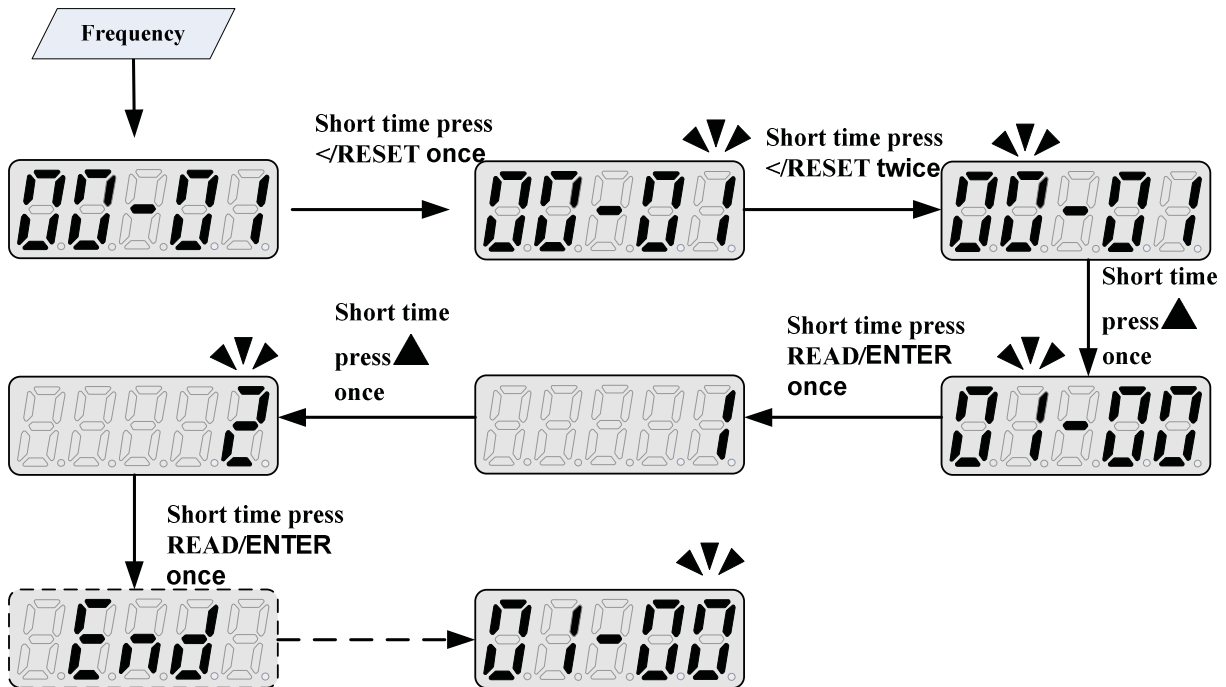

Example2: Modifying the frequency from keypad in run and stop modes.

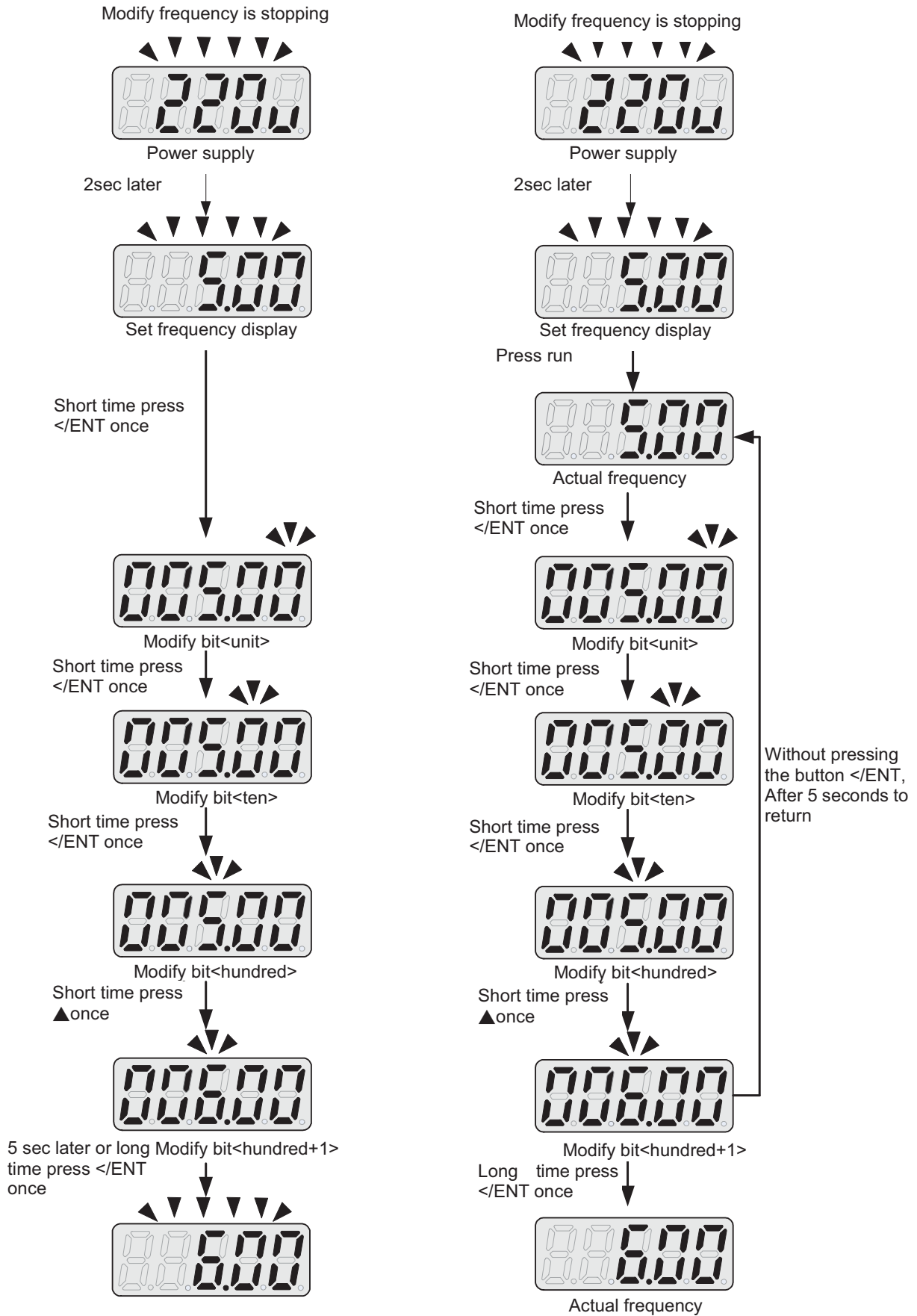

Note: frequency command setting will be limited to the range set by parameters for lower & upper frequency.

4.1.5 Operation Control

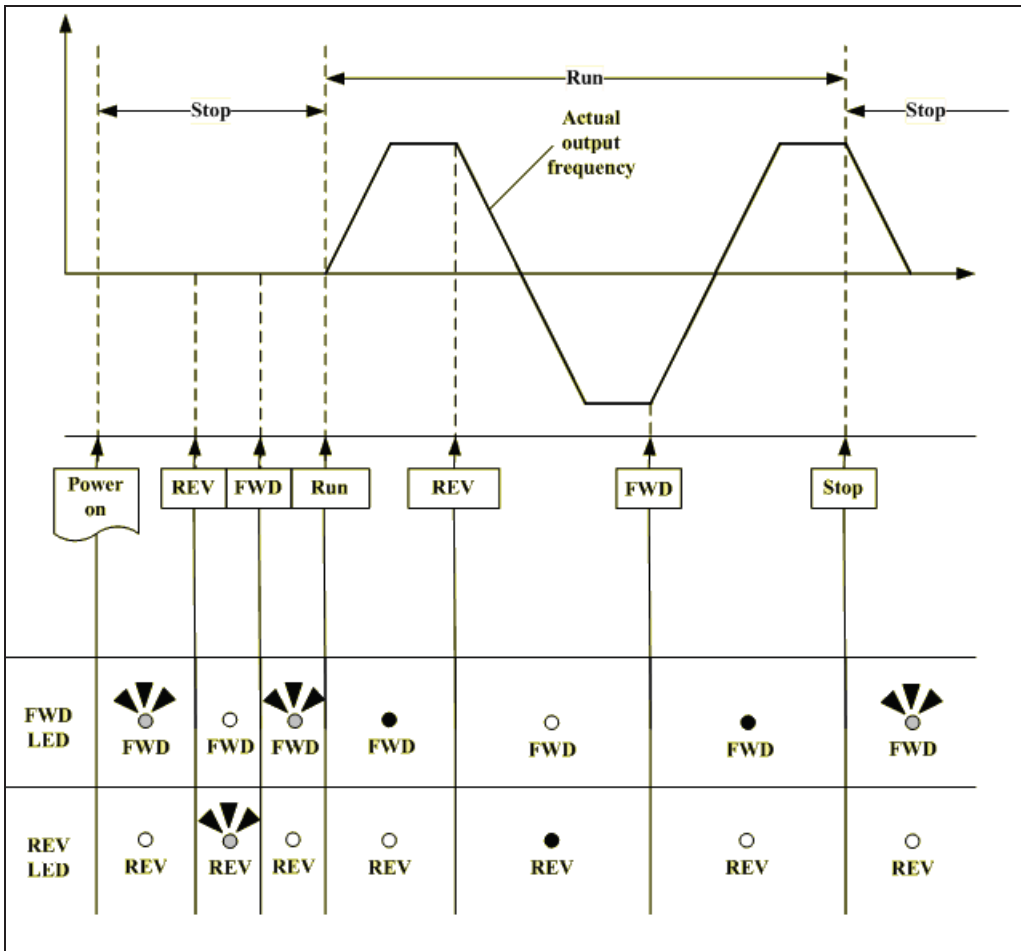

4.2 Programmable Parameter Groups

Parameter Group No.	Description
Group 00	Basic parameters
Group 01	V/F Pattern selections & setup
Group 02	Motor parameters
Group 03	Multi function digital Inputs/Outputs
Group 04	Analog signal inputs/ Analog output
Group 05	Preset Frequency Selections.
Group 06	Auto Run(Auto Sequencer) function
Group 07	Start/Stop command setup
Group 08	Drive and motor Protection
Group 09	Communication function setup
Group 10	PID function setup
Group 11	Performance control functions
Group 12	Digital Display & Monitor functions
Group 13	Inspection & Maintenance function

Parameter notes for Parameter Groups	
*1	Parameter can be adjusted during running mode
*2	Cannot be modified in communication mode
*3	Does not change with factory reset
*4	Read only

Group 00- The basic parameters group					
No.	Description	Range	Factory Setting	Unit	Note
00-00	Reserved				
00-01	Motor rotation	0:Forward 1:Reverse	0	-	*1
00-02	Main Run Source Selection	0:Keypad	0	-	
		1:External Run/Stop Control			
		2:Communication			
00-03	Alternative Run Source Selection	0:Keypad	0	-	
		1:External Run/Stop Control			
		2:Communication			
00-04	Operation modes for external terminals	0: Forward/Stop-Reverse/Stop	0	-	
		1: Run/Stop-Reverse/Forward			
		2: 3-Wire Control Mode-Run/Stop			
00-05	Main Frequency Source Selection	0:Keypad	0	-	
		1:Potentiometer on Keypad			
		2:External AVI Analog Signal Input			
		3:External ACI Analog Signal Input			
		4:External Up/Down Frequency Control			
		5:Communication setting Frequency			
6:PID output frequency					
00-06	Alternative Frequency Source Selection	0:Keypad	4	-	
		1:Potentiometer on Keypad			
		2:External AVI Analog Signal Input			
		3:External ACI Analog Signal Input			
		4:External Up/Down Frequency Control			
		5:Communication setting Frequency			
6:PID output frequency.					
00-07	Main and Alternative Frequency Command modes	0: Main Or Alternative Frequency 1: Main frequency+Alternative Frequency	0	-	
00-08	Communication Frequency Command	0.00~650.00		Hz	*4
00-09	Frequency command Save mode (Communication mode)	0:Save the frequency before power down 1:Save the communication frequency	0	-	
00-10	Initial Frequency Selection (keypad mode)	0:by Current Frequency Command	0	-	
		1:by 0 Frequency Command			
		2:by 00-11			
00-11	Initial Frequency Keypad mode	0.00~650.00	50.00/60.00	Hz	
00-12	Frequency Upper Limit	0.01~650.00	50.00/60.00	Hz	
00-13	Frequency Lower Limit	0.00~649.99	0.00	Hz	
00-14	Acceleration Time 1	0.1~3600.0	10.0	s	*1
00-15	Deceleration Time 1	0.1~3600.0	10.0	s	*1
00-16	Acceleration Time 2	0.1~3600.0	10.0	s	*1
00-17	Deceleration Time 2	0.1~3600.0	10.0	s	*1
00-18	Jog Frequency	1.00~25.00	2.00	Hz	*1
00-19	Jog Acceleration Time	0.1~25.5	0.5	s	*1
00-20	Jog Deceleration Time	0.1~25.5	0.5	s	*1

Group 01- V/F Pattern selection & Setup					
No.	Description	Range	Factory Setting	Unit	Note
01-00	Volts/Hz Patterns	1~7	1/4	-	
01-01	V/F Max voltage	198.0~256.0	220.0	Vac	
01-02	Max Frequency	0.20 ~ 650.00	50.00/60.00	Hz	
01-03	Max Frequency Voltage Ratio	0.0 ~ 100.0	100.0	%	
01-04	Mid Frequency 2	0.10 ~ 650.00	25.00/30.00	Hz	
01-05	Mid Frequency Voltage Ratio 2	0.0 ~ 100.0	50.0	%	
01-06	Mid Frequency 1	0.10 ~ 650.00	10.00/12.00	Hz	
01-07	Mid Frequency Voltage Ratio 1	0.0 ~ 100.0	20.0	%	
01-08	Min Frequency	0.10 ~ 650.00	0.50/0.60	Hz	
01-09	Min Frequency Voltage Ratio	0.0 ~ 100.0	1.0	%	
01-10	Volts/Hz Curve Modification (Torque Boost)	0 ~ 10.0	0.0	%	*1
01-11	V/F start Frequency	0.00~10.00	0.00	Hz	

Group 02- Motor parameters					
No.	Description	Range	Factory Setting	Unit	Note
02-00	Motor No Load Current	----		A	*3
02-01	Motor Rated Current (OL1)	----		A	
02-02	Motor rated Slip Compensation	0.0 ~ 100.0	0.0	%	*1
02-03	Motor Rated Speed	----		Rpm	

Group 03- Multi function Digital Inputs/Outputs					
No.	Description	Range	Factory Setting	Unit	Note
03-00	Multifunction Input Term. S1	0:Forward/Stop Command or Run /Stop	0	-	
03-01	Multifunction Input Term. S2	1:Reverse/Stop Command Or REV/FWD	1	-	
03-02	Multifunction Input Term. S3	2:Preset Speed 1 (5-02)	8	-	
03-03	Multifunction Input Term. S4	3:Preset Speed 2 (5-03)	9	-	
03-04	Multifunction Input Term. S5	4:Preset Speed 4 (5-05)	17	-	
		6:Jog Forward Command			
		7:Jog Reverse Command			
		8:Up Command			
		9:Down Command			
		10:Acc/Dec 2			
		11:Acc/Dec Disabled			
		12:Main/Alternative Run Command select			
		13:Main/Alternative Frequency Command select			
		14:Rapid Stop (Decel to stop)			
15:Base Block					
16:Disable PID Function					
17:Reset					
18:Auto Run Mode enable					
03-05	Reserved				
03-06	Up/Down frequency band	0.00~5.00	0.00	Hz	
03-07	Up/Down Frequency modes	0:When Up/Down is used, the preset frequency is held as the inverter stops, and the UP/Down function is disabled.	0	-	
		1:When Up/Down is used, the preset frequency is reset to 0 Hz as the inverter stops.			
		2:When Up/Down is used, the preset frequency is held as the inverter stops, and the UP/Down is available.			
03-08	S1~S5 scan confirmation	1~400. Number of Scan cycles	20	1ms	
03-09	S1~ S5 switch type select	xxxx0:S1 NO xxx1:S1 NC	00000	-	
		xxx0x:S2 NO xxx1x:S2 NC			
		xx0xx:S3 NO xx1xx:S3 NC			
		x0xxx:S4 NO x1xxx:S4 NC			
		0xxxx:S5 NO 1xxxx:S5 NC			
03-10	Reserved				
03-11	Output Relay(RY1)	0:Run	0	-	
		1:Fault			
		2:setting Frequency			
		3:Frequency Reached (3-13±3-14)			
		4:Frequency Threshold Level (> 3-13) - Frequency Reached			
		5:Frequency Threshold Level (< 3-13) - Frequency Reached			
		6:Auto Restart			
		7:Momentary AC Power Loss			
		8:Rapid Stop Mode			
		9:Base Block Stop Mode			
		10:Motor Overload Protection(OL1)			
11:Drive Overload Protection(OL2)					

		13:Output current Reached			
		14:Brake control			
03-12	Reserved				
03-13	Output frequency detection level (Hz)	0.00~650.00	0.00	Hz	*1
03-14	Frequency Detection band	0.00~30.00	2.00	Hz	*1
03-15	Output current detection level.	0.1~15.0	0.1	A	
03-16	Output current detection period.	0.1~10.0	0.1	s	
03-17	External Brake Release level	0.00~20.00	0.00	Hz	
03-18	External Brake Engage Level	0.00~20.00	0.00	Hz	
03-19	Relay Output function type	0:A (Normally open) 1:B (Normally close)	0	-	

※ “NO”: Normally open, “NC”: Normally close.

Group 04- Analog signal inputs/ Analogue output functions						
No.	Description	Range		Factory Setting	Unit	Note
04-00	AVI/ACI analog Input signal type select	AVI	ACI	0	-	
		0:0~10V	0~20mA			
		1:0~10V	4~20mA			
		2:2~10V	0~20mA			
		3:2~10V	4~20mA			
04-01	AVI Signal Verification Scan rate	1~400		100	1ms	
04-02	AVI Gain	0 ~ 1000		100	%	*1
04-03	AVI Bias	0 ~ 100		0	%	*1
04-04	AVI Bias Selection	0: Positive	1: Negative	0	-	*1
04-05	AVI Slope	0: Positive	1: Negative	0	-	*1
04-06	ACI Signal Verification Scan rate	1~400		100	1ms	
04-07	ACI Gain	0 ~ 1000		100	%	*1
04-08	ACI Bias	0 ~ 100		0	%	*1
04-09	ACI Bias Selection	0: Positive	1: Negative	0	-	*1
04-10	ACI Slope	0: Positive	1: Negative	0	-	*1
04-11	Analog Output mode(AO)	0: Output Frequency 1: Frequency Command 2: Output Voltage 3: DC Bus Voltage 4: Motor Current		0	-	*1
04-12	Analog Output AO Gain (%)	0 ~ 1000		100	%	*1
04-13	Analog Output AO Bias (%)	0 ~ 1000		0	%	*1
04-14	AO Bias Selection	0: Positive	1: Negative	0	-	*1
04-15	AO Slope	0: Positive	1: Negative	0	-	*1

Group 05- Preset Frequency Selections.					
No.	Description	Range	Factory Setting	Unit	Note
05-00	Preset Speed Control mode Selection	0: Common Accel/Decel Accel/Decel 1 or 2 apply to all speeds	0	-	
		1: Individual Accel/Decel Accel/ Decel 0-7 apply to the selected preset speeds (Acc0/Dec0~ Acc7/Dec7)			
05-01	Preset Speed 0 (Keypad Freq)	0.00 ~ 650.00	5.00	Hz	
05-02	Preset Speed1 (Hz)		5.00	Hz	*1
05-03	Preset Speed2 (Hz)		10.00	Hz	*1
05-04	Preset Speed3 (Hz)		20.00	Hz	*1
05-05	Preset Speed4 (Hz)		30.00	Hz	*1
05-06	Preset Speed5 (Hz)		40.00	Hz	*1
05-07	Preset Speed6 (Hz)		50.00	Hz	*1
05-08	Preset Speed7 (Hz)		50.00	Hz	*1
05-09 ~ 05-16	Reserved				
05-17	Preset Speed0-Acctime	0.1 ~ 3600.0	10.0	s	*1
05-18	Preset Speed0-Dectime		10.0	s	*1
05-19	Preset Speed1-Acctime		10.0	s	*1
05-20	Preset Speed1-Dectime		10.0	s	*1
05-21	Preset Speed2-Acctime		10.0	s	*1
05-22	Preset Speed2-Dectime		10.0	s	*1
05-23	Preset Speed3-Acctime		10.0	s	*1
05-24	Preset Speed3-Dectime		10.0	s	*1
05-25	Preset Speed4-Acctime		10.0	s	*1
05-26	Preset Speed4-Dectime		10.0	s	*1
05-27	Preset Speed5-Acctime		10.0	s	*1
05-28	Preset Speed5-Dectime		10.0	s	*1
05-29	Preset Speed6-Acctime		10.0	s	*1
05-30	Preset Speed6-Dectime		10.0	s	*1
05-31	Preset Speed7-Acctime		10.0	s	*1
05-32	Preset Speed7-Dectime		10.0	s	*1

Group 06- Auto Run(Auto Sequencer) function					
No.	Description	Range	Factory Setting	Unit	Note
06-00	Auto Run (sequencer) mode selection	0: Disabled. 1: Single cycle. (Continues to run from the Unfinished step if restarted). 2: Periodic cycle. (Continues to run from the unfinished step if restarted). 3: Single cycle, then holds the speed Of final step to run. (Continues to run from the unfinished step if restarted). 4: Single cycle. (Starts a new cycle if restarted). 5: Periodic cycle. (Starts a new cycle if restarted). 6: Single cycle, then hold the speed of final step to run (Starts a new cycle if restarted).	0	-	
06-01	Auto _ Run Mode frequency command 1	0.00~650.00	0.00	Hz	*1
06-02	Auto _ Run Mode frequency command 2		0.00	Hz	*1
06-03	Auto _ Run Mode frequency command 3		0.00	Hz	*1
06-04	Auto _ Run Mode frequency command 4		0.00	Hz	*1
06-05	Auto _ Run Mode frequency command 5		0.00	Hz	*1
06-06	Auto _ Run Mode frequency command 6		0.00	Hz	*1
06-07	Auto _ Run Mode frequency command 7		0.00	Hz	*1
06-08 ~ 06-15	Reserved				
06-16	Auto_ Run Mode running time setting 0	0.0 ~ 3600.0	0.0	s	
06-17	Auto_ Run Mode running time setting 1		0.0	s	
06-18	Auto_ Run Mode running time setting 2		0.0	s	
06-19	Auto_ Run Mode running time setting 3		0.0	s	
06-20	Auto_ Run Mode running time setting 4		0.0	s	
06-21	Auto_ Run Mode running time setting 5		0.0	s	
06-22	Auto_ Run Mode running time setting 6		0.0	s	
06-23	Auto_ Run Mode running time setting 7	0.0	s		
06-24 ~ 06-31	Reserved				
06-32	Auto_ Run Mode running direction 0	0: Stop	0	-	
06-33	Auto_ Run Mode running direction 1	1: Forward 2: Reverse	0	-	

06-34	Auto_Run Mode running direction 2		0	-	
06-35	Auto_Run Mode running direction 3		0	-	
06-36	Auto_Run Mode running direction 4		0	-	
06-37	Auto_Run Mode running direction 5		0	-	
06-38	Auto_Run Mode running direction 6		0	-	
06-39	Auto_Run Mode running direction 7		0	-	

Group 07- Start/Stop command setup					
No.	Description	Range	Factory Setting	Unit	Note
07-00	Momentary Power Loss and Restart	0: Momentary Power Loss and Restart disable 1: Momentary power loss and restart enable	0	s	
07-01	Auto Restart Delay Time	0.0~800.0	0.0	s	
07-02	Number of Auto Restart Attempts	0~10	0	-	
07-03	Reset Mode Setting	0: Enable Reset Only when Run Command is Off 1: Enable Reset when Run Command is On or Off	0	-	
07-04	Direct Running After Power Up	0: Enable Direct run on power up 1: Disable Direct run on power up	1	-	
07-05	Delay-ON Timer	1.0~300.0	1.0	s	
07-06	DC Injection Brake Start Frequency (Hz) In Stop mode	0.10 ~ 10.00	1.5	Hz	
07-07	DC Injection Brake Level (%) In stop mode	0 ~20	5	%	
07-08	DC Injection Brake Time (Seconds) In stop mode	0.0 ~ 25.5	0.5	s	
07-09	Stopping Method	0: Deceleration to stop 1: Coast to stop	0		

Group 08- Drive & Motor Protection functions					
No.	Description	Range	Factory Setting	Unit	Note
08-00	Trip Prevention Selection	xxxx0: Enable Trip Prevention During Acceleration xxxx1: Disable Trip Prevention During Acceleration xxx0x: Enable Trip Prevention During Deceleration xxx1x: Disable Trip Prevention During Deceleration xx0xx: Enable Trip Prevention in Run Mode xx1xx: Disable Trip Prevention in Run Mode x0xxx: Enable over voltage Prevention in Run Mode x1xxx: Disable over voltage Prevention in Run Mode	00000	-	
08-01	Trip Prevention Level During Acceleration (%)	50 ~ 200	200	Inverter Rated Current 100%	
08-02	Trip Prevention Level During Deceleration (%)	50 ~ 200	200		
08-03	Trip Prevention Level In Run Mode (%)	50 ~ 200	200		
08-04	over voltage Prevention Level in Run Mode	350~390	380	VDC	
08-05	Electronic Motor Overload Protection Operation Mode	0: Enable Electronic Motor Overload Protection 1: Disable Electronic Motor Overload Protection	0	-	
08-06	Operation After Overload Protection is Activated	0: Coast-to-Stop After Overload Protection is Activated 1: Drive Will Not Trip when Overload Protection is Activated (OL1)	0	-	
08-07	Over heat Protection (cooling fan control)	0: Auto (Depends on temp.) 1: Operate while in RUN mode 2: Always Run 3: Disabled	1	-	
08-08	AVR Function (Auto Voltage Regulation)	0: AVR function enable 1: AVR function Disable 2: AVR function disable for stop 3: AVR function disable for deceleration 4: AVR function disable for stop and deceleration. 5: When VDC>360V, AVR function disable for stop and deceleration.	4	-	
08-09	Input phase lost protection	0: Disabled 1: Enabled	0	-	

Group 09- Communication function setup					
No.	Description	Range	Factory Setting	Unit	Note
09-00	Assigned Communication Station Number	1 ~ 32	1	-	*2*3
09-01	RTU code /ASCII code select	0:RTU code 1:ASCII code	0	-	*2*3
09-02	Baud Rate Setting (bps)	0:4800 1:9600 2:19200 3:38400	2	bps	*2*3
09-03	Stop Bit Selection	0:1 Stop Bit 1:2 Stop Bits	0	-	*2*3
09-04	Parity Selection	0:Without Parity 1:With Even Parity 2:With Odd Parity	0	-	*2*3
09-05	Data Format Selection	0: 8-Bits Data 1: 7-Bits Data	0	-	*2*3
09-06	Communication time-out detection time	0.0 ~ 25.5	0.0	s	
09-07	Communication time-out operation selection	0:Deceleration to stop (00-15: Deceleration time 1) 1:Coast to stop 2: Deceleration to stop (00-17: Deceleration time 2) 3: continue operating	0	-	
09-08	Error 6 verification time.	1 ~ 20	3		
09-09	Drive Transmit delay Time (ms)	5 ~ 65	5	ms	

Group10- PID function Setup					
No.	Description	Range	Factory Setting	Unit	Note
10-00	PID target value selection (when 00-03\00-04=6 ,this function is enabled)	0:Potentiometer on Keypad 1: Analog Signal Input. (AVI) 2: Analog Signal Input. (ACI) 3: Frequency set by communication 4: KeyPad Frequency parameter 10-02	1	-	*1
10-01	PID feedback value selection	0:Potentiometer on Keypad 1: Analog Signal Input. (AVI) 2: Analog Signal Input. (ACI) 3: Frequency set by communication	2	-	*1
10-02	PID Target (keypad input)	0.0~100.0	50.0	%	*1
10-03	PID Mode Selection	0:Disabled 1: Deviation D Control. FWD Characteristic. 2: Feedback D Control FWD Characteristic. 3: Deviation D Control Reverse Characteristic. 4: Feedback D Control Reverse Characteristic.	0	-	
10-04	Feedback Gain Coefficient	0.00 ~ 10.00	1.00	%	*1
10-05	Proportional Gain	0.0 ~ 10.0	1.0	%	*1
10-06	Integral Time	0.0 ~ 100.0	10.0	s	*1
10-07	Derivative Time	0.00 ~ 10.00	0.00	s	*1
10-08	PID Offset	0: Positive 1: Negative	0	-	*1
10-09	PID Offset Adjust	0 ~ 109	0	%	*1
10-10	PID Output Lag Filter Time	0.0 ~ 2.5	0.0	s	*1
10-11	Feedback Loss Detection Mode	0: Disabled 1: Enabled - Drive Continues to Operate After Feedback Loss 2: Enabled - Drive "STOPS" After Feedback Loss	0	-	
10-12	Feedback Loss Detection Level	0 ~ 100	0	%	
10-13	Feedback Loss Detection Delay Time	0.0 ~25.5	1.0	s	
10-14	Integration Limit Value	0 ~ 109	100	%	*1
10-15	Integral Value Resets to Zero when Feedback Signal Equals the Target Value	0:Disabled 1: 1 Second 30: 30 Seconds(0 ~ 30)	0	-	
10-16	Allowable Integration Error Margin (units)(1unit = 1/8192)	0 ~ 100	0	-	
10-17	PID Sleep Frequency Level	0.00~650.00	0.00	Hz	
10-18	PID Sleep Function Delay Time	0.0 ~25.5	0.0	s	
10-19	PID Wake up frequency Level	0.00 ~ 650.00	0.00	Hz	
10-20	PID Wake up function Delay Time	0.0 ~ 25.5	0.0	s	
10-21	Max PID Feedback Setting	0 ~999	100	-	*1
10-22	Min PID Feedback Setting	0 ~999	0	-	*1

Group11- Performance Control functions					
No.	Description	Range	Factory Setting	unit	Note
11-00	Reverse operation control	0: Reverse command is enabled 1: Reverse command is disabled	0	-	
11-01	Carrier Frequency (kHz)	1~16	5	KHz	
11-02	Carrier mode Selection	0: Mode0, 3phase PWM modulation 1: Mode1, 2phase PWM modulation 2: Mode2, 2phase random PWM modulation	0	-	
11-03	Carrier Frequency Reduction by temperature rise	0:disabled 1:enabled	0	-	
11-04	S-Curve Acc 1	0.0 ~ 4.0	0.00	s	
11-05	S-Curve Acc 2	0.0 ~ 4.0	0.00	s	
11-06	S-Curve Dec 3	0.0 ~ 4.0	0.00	s	
11-07	S-Curve Dec 4	0.0 ~ 4.0	0.00	s	
11-08	Skip Frequency 1	0.00 ~ 650.00	0.00	Hz	*1
11-09	Skip Frequency 2	0.00 ~ 650.00	0.00	Hz	*1
11-10	Skip Frequency 3	0.00 ~ 650.00	0.00	Hz	*1
11-11	Skip Frequency Bandwidth (±)	0.00 ~ 30.00	0.00	Hz	*1

Group12 Digital Display & Monitor functions					
No.	Description	Range	Factory Setting	Unit	Note
12-00	Extended Display Mode	00000 ~77777. Each digit can be set to 0 to 7	00000	-	*1
		0: Default display (frequency¶meters)			
		1:Output Current			
		2:Output Voltage			
		3:DC voltage			
		4:Temperature			
		5:PID feedback			
		6: Analog Signal Input. (AVI) 7: Analog Signal Input. (ACI)			
12-01	PID Feedback Display format	0: Integer (xxx)	0	-	*1
		1:One decimal Place (xx.x)			
		2:Two Decimal Places (x.xx)			
12-02	PID Feedback Display Unit Setting	0:xxx--	0	-	*1
		1:xxxpb (pressure)			
		2:xxxfl (flow)			
12-03	Custom Units (Line Speed) Value	0~65535	1500/1800	RPM	*1
12-04	Custom Units (Line Speed) Display Mode	0:Drive Output Frequency is Displayed	0	-	*1
		1:Line Speed. Integer.(xxxxx)			
		2:Line Speed..One Decimal Place (xxxx.x)			
		3:Line Speed.Two Decimal Places (xxx.xx)			
		4:Line Speed.Three Decimal Places (xx.xxx)			

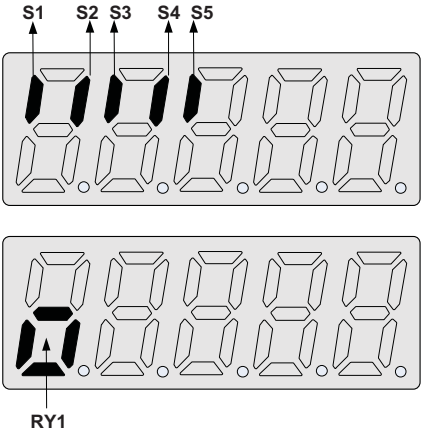
12-05	Inputs and output Logic status display (S1 to S5) & RY1		-	-	*4
--------------	--	---	---	---	----

Group 13 Inspection & Maintenance functions					
No.	Description	Range	Factory Setting	unit	Note
13-00	Drive Horsepower Code	----	-	-	*3
13-01	Software Version	----	-	-	*3*4
13-02	Fault Log (Last 3 Faults)	----	-	-	*3*4
13-03	Accumulated Operation Time1 1	0~23	-	hour	*3
13-04	Accumulated Operation Time1 2	0~65535	----	day	*3
13-05	Accumulated Operation Time Mode	0:Time Under Power 1:Run Mode Time Only	0	-	*3
13-06	Parameter Lock	0: Enable all Functions 1: Preset speeds 05-01~05-08 cannot Be changed. 2: All Functions cannot be changed Except for Preset speeds 05-01~05-08. 3: Disable All Function.	0	-	
13-07	Parameter Lock Code	00000~65535	00000	-	
13-08	Reset Drive to Factory Settings	1150: Reset to factory setting. 50Hz system. 1160: Reset to factory setting. 60Hz system.	00000	-	

4.3 Parameter Function Description

00- Basic parameter group

00- 01	Motor Direction Control
Range	【0】 : Forward 【1】 : Reverse

➤ 00 - 01 Is valid in key pad mode only.

※Note: When Reverse function is disabled by parameter 11- 00=1 setting 00-01 to 1 ." LOC" will be displayed

00- 02	Main Run Command Source selection
00- 03	Alternative Run Command Source selection
Range	【0】 : Keypad 【1】 : External Run/Stop Control 【2】 : Communication

➤ Parameter 00 - 02/00- 03 sets the inverter operation command source. For switching between 00-02 and 00-03, use any of the external inputs S1 to S5 and set the relevant parameters (03-00~03-04) to [12]. refer to parameter group3.

00- 04	Operation modes for external terminals
Range	【0】 : Forward/stop-reverse/stop 【1】 : Run/stop-forward/reverse 【2】 : 3-wire control mode -run/stop

➤ 00-04 Is valid when Run command is set to External mode by 00- 02/00- 03 =1.

2-wire operation mode:

Set 00-04= 【0/1】 first, before setting (03-00,03-04) to[0] or [1]

00-04= 【0】 Set external terminals (03-00 to 03-04) function to 0 for FWD/Stop or Set to 1 for REV/Stop.

00-04= 【1】 Set external terminals (03-00 to 03-04) function to 0 for Run/Stop or Set to 1 for FWD/REV.

3-wire operation mode:

00-04 = 【2】 Terminals S1, S2, S3 are used in a combination to enable 3 wire run/stop mode.

Settings for 03-00, 03-01, 03-02 will not be effective. (refer to Group 03)

00- 05	Main Frequency Command Source Selection
00- 06	Alternative Frequency Command Source Selection
Range	【0】 :UP/DOWN of Keypad 【1】 :Potentiometer on Keypad 【2】 :External AVI Analog Signal Input 【3】 :External ACI Analog Signal Input 【4】 :External Up/Down Frequency Control 【5】 :Communication setting Frequency 【6】 :PID Output frequency

➤ When 00-06 =[6], frequency command source is output of the PID.

00- 07	Main and Alternative Frequency Command Modes
Range	【0】 :Main Or Alternative Frequency. 【1】 :Main frequency + Alternative Frequency

➤ When 00-07= **【0】** , the frequency source is set by the **Main frequency** parameter 00-05 (Default) or by the **Alternative frequency** parameter 00-06.

Use any of the external terminals S1 to S5 and set the relevant parameter 03-00 to 03-04 = **【13】** to switch from **main** to **Alternative** source.

➤ When 00 - 07 = **【1】** The Frequency command will be the result of setting of Main & alternative frequencies.

00- 08	Communication Frequency Command
Range	【0.00~650.00】 Hz

- This parameter can be used to set frequency command
- This parameter can be used to read the set frequency in communication mode
- This parameter is only effective in the communication mode.

00- 09	Frequency Command save on power down (Communication mode)
Range	【0】 :disable 【1】 :enable

- 00-09= **【0】** Keypad frequency is saved.
- 00-09= **【1】** Frequency set by communication is saved.

00-10	Initial Frequency Selection
Range	【0】 :By Current Freq Command 【1】 :By Zero Freq Command 【2】 :By 00-11

00-11	Initial Frequency Setpoint
Range	【0.00~650.00】 Hz

- This parameter is only effective in keypad mode..
- When 00-10= **【0】** The initial frequency will be current frequency.
- When 00-10= **【1】** Tthe initial frequency will be 0.
- When 00-10= **【2】** The initial frequency will be as set by parameter 00-11.

00-12	Frequency Upper limit
Range	【0.01~650.00】 Hz
00-13	Frequency Lower limit
Range	【0.00~649.99】 Hz

- When 00-13 and the command frequency are both set to 0.00, if RUN is pressed” Stpo” is displayed.
- When Frequency command is > than preset in 00-13 inverter output will ramp up from 0.00 to the command frequency.
- When 00-13> 0, and the frequency command value ≤ 00-13, inverter output will ramp up from preset in lower limit to the command frequency.

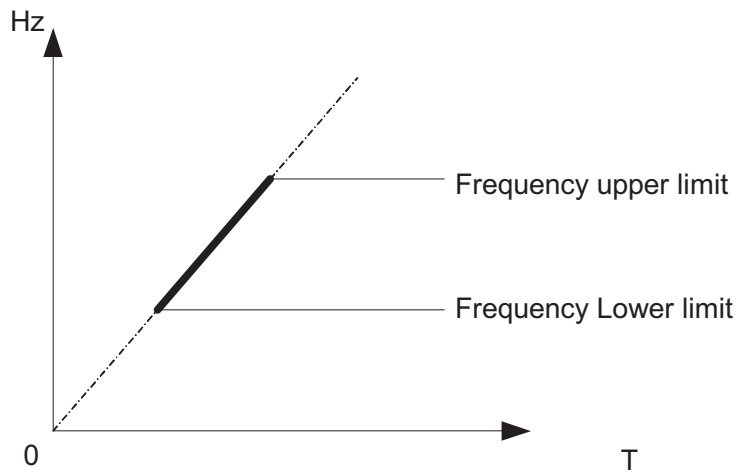

00-14	Acceleration time 1
Range	【0.1~3600.0】 s
00-15	Deceleration time 1
Range	【0.1~3600.0】 s
00-16	Acceleration time 2
Range	【0.1~3600.0】 s
00-17	Deceleration time 2
Range	【0.1~3600.0】 s

- Preset Acceleration and Deceleration times by above parameters are the time taken for the output frequency to ramp up or ramp down between the Upper and the lower frequency limits.
- **Actual acceleration and deceleration time is calculated as follows:**

$$\text{Actual acceleration time} = \frac{(00-14) \times (\text{set frequency} - \text{the minimum starting frequency})}{\text{Maximum output frequency}}$$

$$\text{Actual deceleration time} = \frac{(00-15) \times (\text{set frequency} - \text{the minimum starting frequency})}{\text{Maximum output frequency}}$$

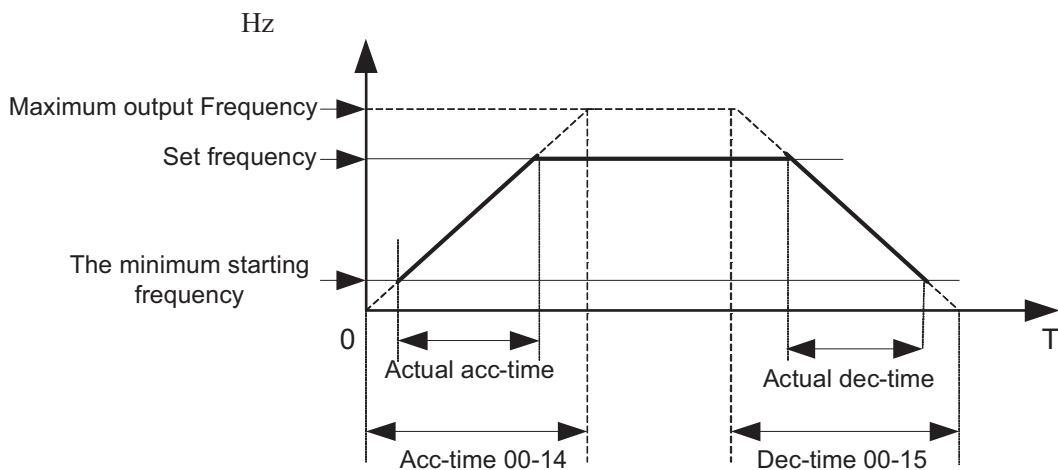

00-18	Jog Frequency
Range	【1.00~25.00】 Hz
00-19	Jog Acceleration Time
Range	【0.1~3600.0】 s
00-20	Jog Deceleration Time
Range	【0.1~3600.0】 s

- The JOG function is operational by using the multi-function input terminals S1 to S5 and setting the relevant parameters 03-00~03-04 to **【6】 JOG FWD** or **【7】 JOG REV**. Refer to parameter group 3.

01-V/F command group	
01- 00	Volts/Hz Patterns (V/F)
Range	【1~7】

- Set 01-00 to one of the following preset V/f selections **【1~6】** according to the required application.
- Parameters 01-02~01-09 are not applicable.
- Six fixed V/f patterns are shown below. **【1~3】** for 50 Hz systems and **【4~6】** for 60 Hz.

TYPE	50Hz		60Hz	
Function	01-00	V/F pattern	01-00	V/F pattern
General Use	= 【1】		= 【4】	
High start torque	= 【2】		= 【5】	

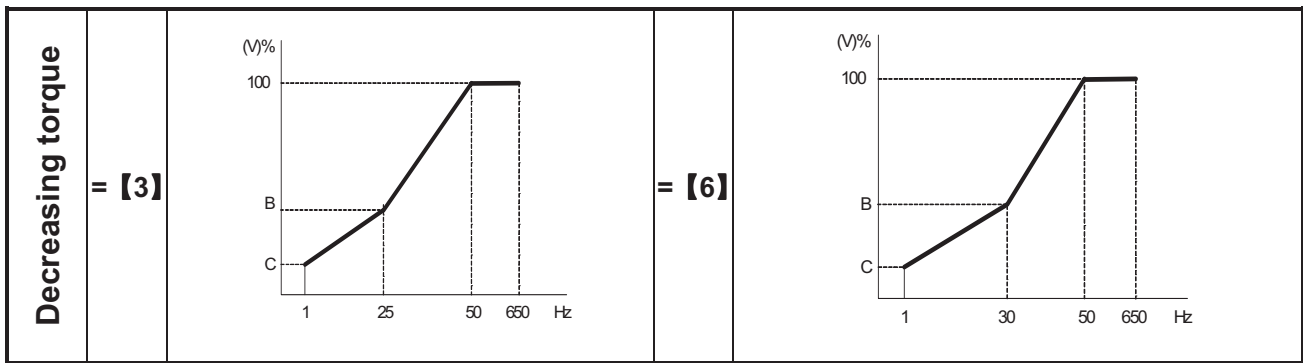

- (V) 100% is the maximum output voltage. B, C point preset % settings will be as table below:-

	01- 00	B(Xb)	C(Xc)
	1/4	10%	8%
	2/5	15%	10.5%
	3/6	25%	7.7%

- Setting 01-00 =[7] provides a flexible V/F curve which can be selected by experienced users by setting parameters (01-02~01-09).

01- 01	v/f Maximum voltage
Range	【198.0~256.0】 V
01- 02	Maximum Frequency
Range	【0.20 ~ 650.00】 Hz
01- 03	Maximum Frequency Voltage Ratio
Range	【0.0 ~ 100.0】 %
01- 04	Medium Frequency 2
Range	【0.10 ~ 650.00】 Hz
01- 05	Medium Frequency Voltage Ratio 2
Range	【0.0 ~ 100.0】 %
01- 06	Medium Frequency 1
Range	【0.10 ~ 650.00】 Hz
01- 07	Medium Frequency Voltage Ratio 1
Range	【0.0 ~ 100.0】 %
01- 08	Minimum Frequency
Range	【0.10 ~ 650.00】 Hz
01- 09	Minimum Frequency Voltage Ratio
Range	【0.0 ~ 100.0】 %

- Max output frequency depends on parameter 01-00 , for 01-00= **【7】** It can be set by parameter 01-02.
- For 01-00 ≠ **【7】** , the maximum output frequency will depend on parameter 00-12, frequency upper limit.

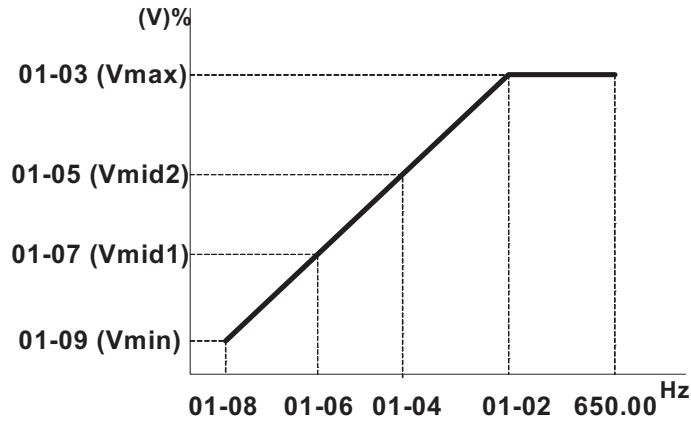

01-10	Volts/Hz Curve Modification (Torque Boost)
Range	【0 ~ 10.0】 %

- Inverter output V / F curve settings for points B, C can be adjusted by parameter 01-10 to improve the output torque.
- Calculation of B, C point voltage: B point voltage = Xb × maximum output voltage, C point voltage = Xc × maximum output voltage (Xb, Xc see Page 4-26). When 01-10 = 0, the torque improvement is disabled.

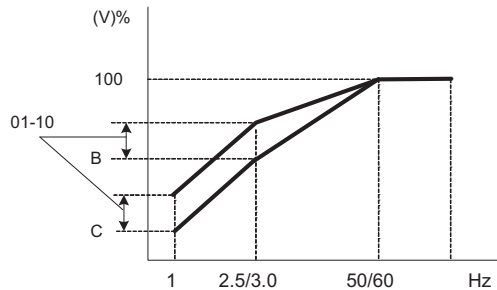

01-11	V/F start Frequency
Range	【0.00 ~10.00】 Hz

02- Motor parameter group

02- 00	Motor no load current
Range	----
02- 01	Motor Rated Current
Range	----
02- 02	Motor rated Slip Compensation
Range	【0.0 ~ 100.0】 (%)
02- 03	Motor Rated Speed
Range	----

- When the load causes the actual motor speed to be reduced below the speed set by inverter output frequency (Slip), parameter 02-02 Slip compensation can be used to correct the speed.

$$\text{Slip compensation boost} = \frac{\text{Output Current}-(02-00)}{(02-01)-(02-00)} \times (02-02) \times \text{Rate motor slip}$$

Motor slip = Motor synchronous speed- Motor Rated Speed

$$(02-02)\text{approximate Value} = \frac{\text{Motor synchronization speed}-\text{Rated speed}}{\text{Motor synchronization speed}}$$

Example: 4 poles, 60Hz induction motor synchronization speed = $\frac{120}{4} \times 60 = 1800(\text{RPM})$

※Note: 02- 00/02- 01 differs with the inverter capacities (13- 00),It should be regulated according to actual conditions.

03- External digital inputs & Relay Output functions

03- 00	Multifunction Input Term. S1
03- 01	Multifunction Input Term. S2
03- 02	Multifunction Input Term. S3
03- 03	Multifunction Input Term. S4
03- 04	Multifunction Input Term. S5
Range	<p>【0】 :Forward/Stop Command------(Parameters 00- 02/00-03=1 & 00-04)</p> <p>【1】 :Reverse/Stop Command------(Parameters 00-02/00-03=1 & 00-04)</p> <p>【2】 :Preset Speed 1 (5- 02)----- (Parameter Group5)</p> <p>【3】 :Preset Speed 2 (5- 03)------(Parameter Group5)</p> <p>【4】 :Preset Speed 4 (5- 05) ------(Parameter Group5)</p> <p>【6】 :JOG Forward Command------(Parameters 00-18~00-20)</p> <p>【7】 :JOG Reverse Command----- (Parameters 00-18~00-20)</p> <p>【8】 :Up Command----- (Parameters 00- 05/00- 06=4& 03-06/03-07)</p> <p>【9】 :Down Command----- (Parameters 00- 05/00- 06=4& 03-06/03-07)</p> <p>【10】 : 2nd Acc/Dec times</p> <p>【11】 : Disable Acc/Dec</p> <p>【12】 : Main/ Alternative run source Select------(Parameters 00- 02/00- 03)</p> <p>【13】 : Main/Alternative Frequency Command Select-----(Parameters 00- 05/00- 06)</p> <p>【14】 : Rapid Stop (controlled deceleration stop)</p> <p>【15】 : Base Block (Coast to stop)</p> <p>【16】 : Disable PID Function.------(Parameter Goup10)</p> <p>【17】 : Reset</p> <p>【18】 : Enable Auto Run Mode------(Parameter Group 6)</p>

Various example settings and descriptions for Parameters 03-00 to 03-04 are noted in the following pages seconds from 1 to 13.

1) For setting parameters 03- 00~03- 04 to **【0, 1】** External Run/Stop Control, refer to 00- 04.

2-wire method. Mode 1.

Example: FWD/STOP and REV/STOP from two inputs (S1&S2)

Set 00- 04= **[0] , S1: 03- 00= **[0]** (FWD/STOP) , S2: 03- 01= **[1]** (REV/STOP);**

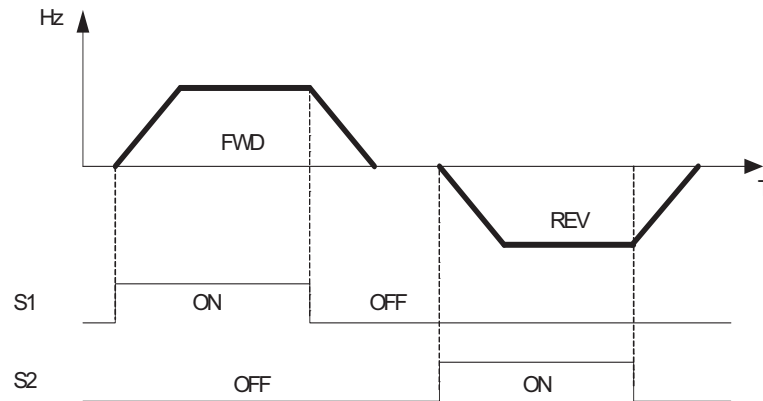
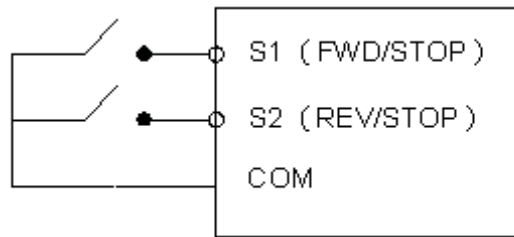

※ **Note:** If both forward and reverse commands are ON, it will be treated as a STOP.

2-wire method. Mode 2.

Example: RUN/STOP and REV/FWD from two inputs (S1&S2)

Set 00- 04= **[1] ; S1: 03- 00= **[0]** (RUN/STOP); S2:03- 01= **[1]** (REV/FWD);**

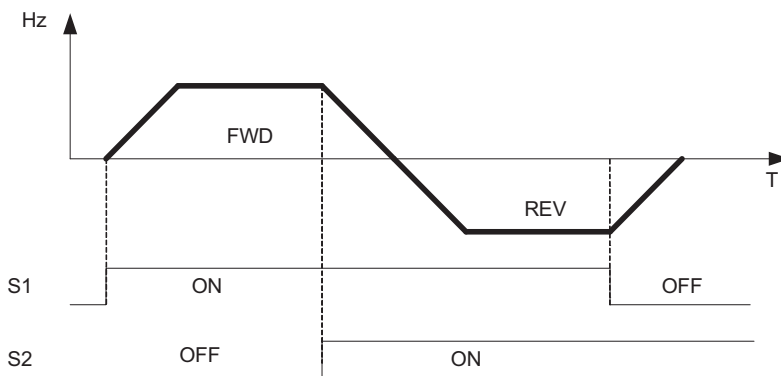
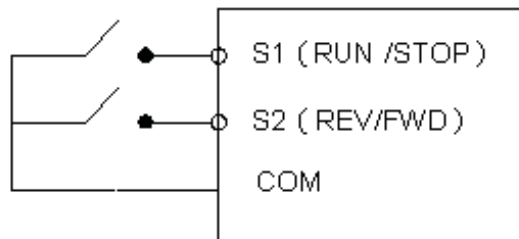

3-wire method.

Example:- Two separate push buttons for RUN & STOP and a two position switch for FWD/ REV

Set 00- 04 =2.(3 wire control mode), then terminals S1, S2 and S3 are dedicated to this function and Preset selections for parameters 03-00, 03-01 and 03-02.are not relevant.

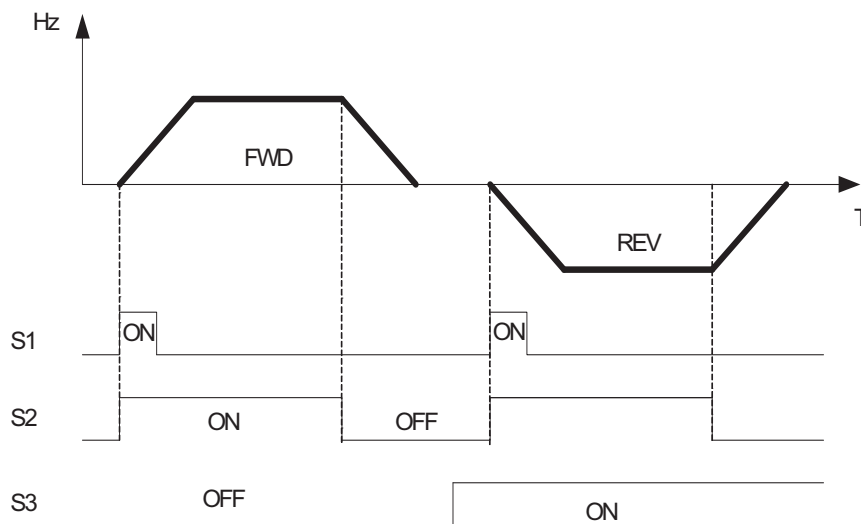
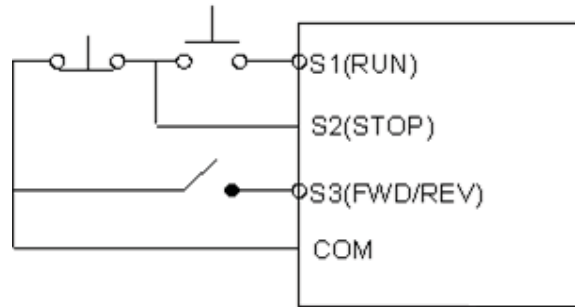

2) Parameters 03- 00~03- 04= [2, 3, 4] Preset speed selections.

Combination of any three terminals from S1~ S5 can be used to select preset speeds 0 to 7 according to the table below.

Preset speed 0-7 and the related acceleration/decelerating times should be set in parameter group 5. For example timing diagram refer to Group 5 description.

Preset speed	Function setting and state of any three (A,B,C) of terminal S1~S5			Frequency	Acc-time	Dec-time
	terminal A=2	terminal B =3	terminal C =4			
speed 0	OFF	OFF	OFF	05- 01	05- 17	05-18
speed 1	OFF	OFF	ON	05- 02	05- 19	05-20
speed 2	OFF	ON	OFF	05- 03	05- 21	05-22
speed 3	OFF	ON	ON	05- 04	05- 23	05-24
speed 4	ON	OFF	OFF	05- 05	05- 25	05-26
speed 5	ON	OFF	ON	05- 06	05- 27	05-28
speed 6	ON	ON	OFF	05- 07	05- 29	05-30
speed 7	ON	ON	ON	05- 08	05- 31	05-32

3) 03- 00~03- 04= 【6 ,7】 Forward/ Reverse JOG

When an input terminal is set to function 【6】 and is turned on, inverter will work in jog forward mode.

When an input terminal is set to function 【7】 and is turned on, inverter will work in jog reverse mode.

Note: If jog forward and jog reverse function is enabled at the same time, inverter will enter stop mode.

4) 03- 00~03- 04= 【8, 9】 UP/DOWN

When an input terminal is set to function 【8】 and is turned on, frequency command is increased according to the UP/DOWN , increment/decrement step set in parameter 03-06.

If the input is kept on continuously, the frequency command increases accordingly until the upper frequency limit is reached.

When an input terminal is set to function 【9】 and is turned on, frequency command decreases according to the UP/DOWN increment/decrement step set in parameter 03-06.

If the input is kept on continuously, the frequency command decreases accordingly and in relation to settings for parameter 03-06 and 3-07 until Zero speed is reached.

Refer to group 3 parameter description.

5) 03- 00~03- 04= 【10】 2nd Acc/Dec time

When an input terminal is set to function 【10】 and is turned on, the actual acceleration and deceleration time will be according to the time for 2nd Accel/Decel set in parameters 00-16 and 00-17. if the input is turned off, the acceleration and deceleration times will be according to the default accel/decal 1 set in parameters 00-14 & 00-15.

6) 03- 00~03- 04= 【11】 Disable Acc/Dec function

When an input terminal is set to function 【11】 and is turned on, acceleration and deceleration function will be disabled and the frequency at the time is maintained. (constant speed mode)

If the input is turned off, acceleration and deceleration function is enabled again.

For an example see the following diagram.

Accel/Decel & Enable/Disable timing diagram using terminal S1 and parameter 03-00 = 11.

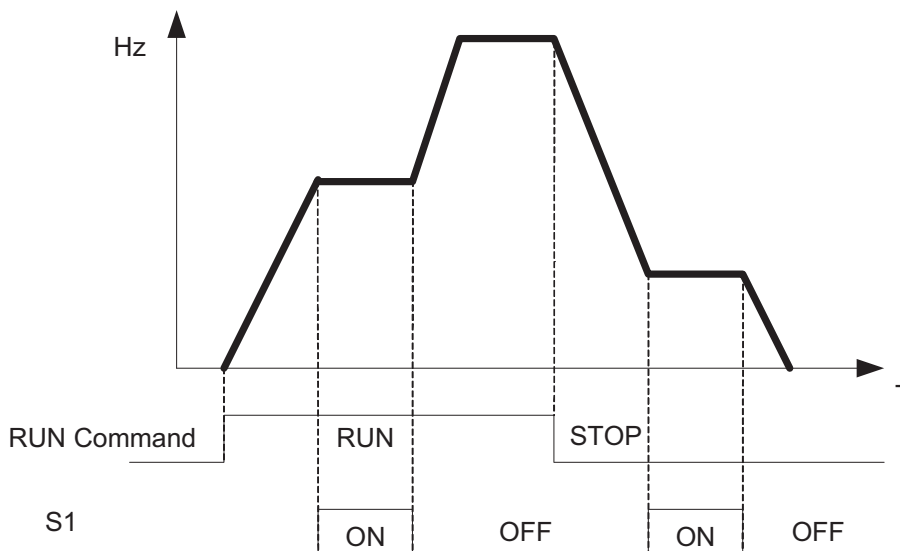

7) 03- 00~03- 04= 【12】 Main/ Alternative run source select.

When an input terminal is set to function 【12】 and is turned on, the run command source is according to parameter 00-03(Alternative Run source).If the Input is off it will be according to 00-02 (Main run source).

8) 03- 00~03- 04= 【13】 Main/ Alternative Frequency source Select

When an input terminal is set to function 【13】 and is turned on, the frequency source is according to parameter 00-06(Alternative Frequency source).If the Input is off it will be according to 00-05 (Main Frequency source).

9) 03- 00~03- 04= 【14】 Rapid Stop (controlled deceleration stop)

When an input terminal is set to function 【14】 and is turned on, inverter decelerates to stop.

10) 03- 00~03- 04= 【15】 Base Block (Coast to stop)

When an input terminal is set to function 【15】 and is turned on, inverter output is turned off.

11) 03- 00~03- 04= 【16】 Disable PID Function.

When an input terminal is set to function 【16】 and is turned on, PID functions is disabled, if it is turned off, PID function is enabled again.

12) 03- 00~03- 04= 【17】 Reset

When a failure that can be manually reset occurs, turn on a terminal with function 【17】 , the failure will be reset. (Same function as the Reset button on keypad).

13) 03- 00~03- 04= 【18】 Auto _ Run Mode

When an input terminal is set to function【18】 , the programmable auto- sequencer function is enabled, Refer to description of parameter group 6.

03- 06	Up/Down frequency step
Range	【0.00~5.00】 Hz

**Example: S1: 03- 00= 【8】 Up frequency command, S2: 03- 01= 【9】 Down frequency command,
03- 06= 【△】 Hz**

Mode1: If UP or DOWN input terminals are turned on for less than 2 seconds, for every activation the frequency command changes by △ Hz.

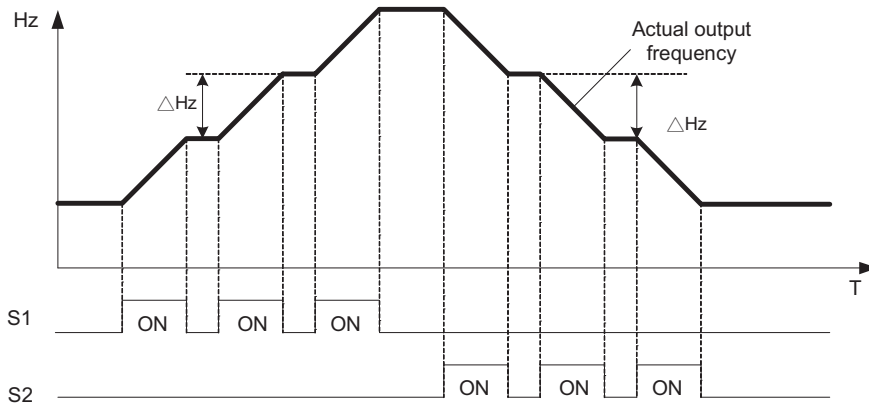

Mode 2: If UP or DOWN input terminals are turned on for more than 2Seconds, the original UP/DOWN mode is restored Output frequency Ramps up or down as long as the input is kept ON.

As shown in the diagram below.

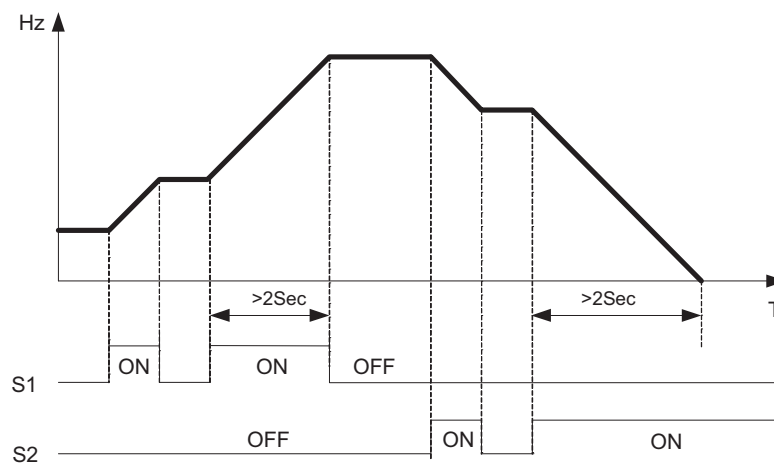

03- 07	Up/Down keep Frequency status after a stop command
Range	<p>【0】 : After a stop command in Up/Down mode, the preset frequency is held as the inverter stops, and the UP/Down function is disabled.</p> <p>【1】 : After a stop command in Up/Down mode, the preset frequency is reset to 0 Hz as the inverter stops.</p> <p>【2】 : After a stop command in Up/Down mode, the preset frequency is held as the inverter stops, and the UP/Down function remains enabled.</p>

- 03 - 07 = **【0】** , **【2】** When run signal is removed (Stop Command), the output frequency is stored in parameter 05-01(Key pad Frequency).
- 03 - 07 = **【0】** In stop mode since frequency can not be increased or decreased from Up/Down terminals then keypad can be used to change the frequency by modifying parameter 05-01.
- 03 - 07 = **【1】** In Up/down frequency mode inverter will ramp up from 0Hz on Run command and Ramp down to 0 Hz on stop command.

03- 08	Multifunction terminals S1~S5 scan time
Range	【1~200】 1m s

- Multifunction input terminal On/Off periods will be scanned for the number of cycles according to the set value in parameter 03-08. If the signal status for On or off period is less than the set period it will be treated as noise.
- Scan period unit is 1ms.
- Use this parameter if unstable input signal is expected, however setting long scan time periods results in slower response times.

03- 09	s1~s5 Input type selection NO & NC
Range	【xxxx0】 :S1 NO 【xxxx1】 :S1 NC 【xxx0x】 :S2 NO 【xxx1x】 :S2 NC 【xx0xx】 :S3 NO 【xx1xx】 :S3 NC 【x0xxx】 :S4 NO 【x1xxx】 :S4 NC 【0xxxx】 :S5 NO 【1xxxx】 :S5 NC

- (NO) Normally open, (NC) Normally closed. Select as required.
- For selecting Normally Open (NO) or Normally Closed(NC) set the relevant digit in parameter 03-09 to 0 or 1 as required.
- Set Parameter 03-09 first before you use the Parameters 00-02/00-03=1 to set the inverter run mode to External multifunction inputs.

03-11	Multifunction Output Relay RY1 functions. (Terminals RA, RB)
Range	【0】 :Run 【1】 :Fault 【2】 :Frequency Reached------(refer to 03-13/03-14) 【3】 :Set Frequency (3-13±3-14) -----(refer to 03-13/03-14) 【4】 :Frequency Threshold Level (> 03-13) - Frequency Reached ------(refer to 03-13/03-14) 【5】 :Frequency Threshold Level (< 03-13) - Frequency Reached ------(refer to 03-13/03-14) 【6】 :Auto-restart 【7】 :Momentary AC Power Loss------(refer to 07-00) 【8】 :Rapid Stop (Decelerate to Stop) 【9】 :Base Block Stop Mode 【10】 :Motor Overload Protection (OL1) 【11】 :Drive Overload Protection (OL2) 【12】 :Reserved 【13】 :Preset Current level Reached------(refer to 03-15/03-16) 【14】 : Preset Brake Frequency Reached------(refer to 03-17/03-18)
03-13	Frequency Reached Preset
Range	【0.00~650.00】 Hz
03-14	Frequency Reached detection Range (±)
Range	【0.00~30.00】 Hz

Output relay RY1. function descriptions:

- 1) 03-11 = **[0]** . RY1 will be ON with Run signal.
- 2) 03-11 = **[1]** . RY1 will be ON with inverter Faults.
- 3) 03-11 = **[2]** . RY1 will be ON as soon as Preset frequency set by parameters 03-13 is reached.

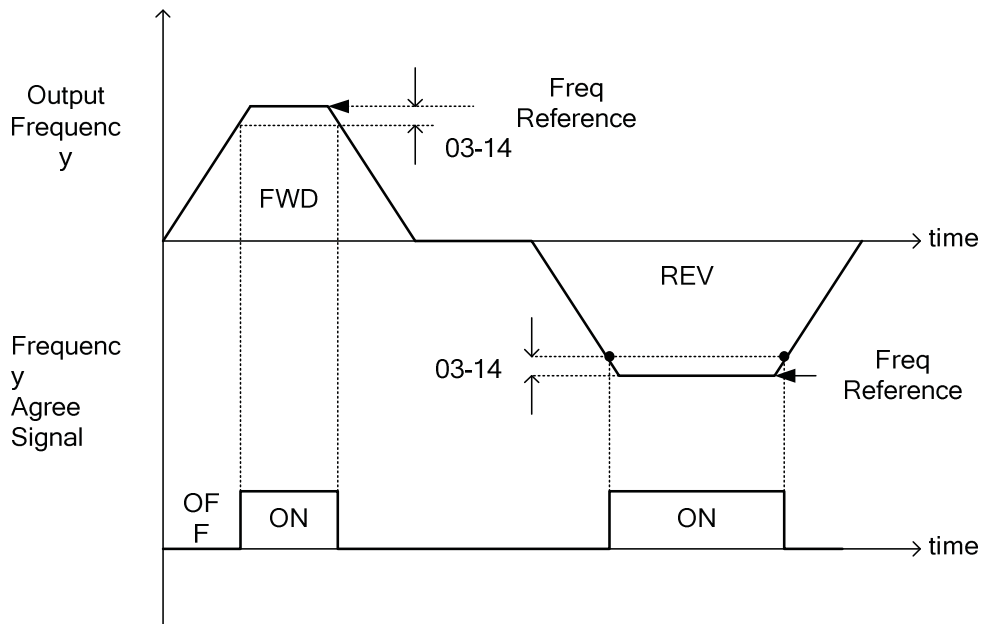

- 4) 03-11= **[3]** RY1 will be on when the preset output frequency set by parameter 03-13 +/- preset frequency range set by parameter 03-14 is reached.

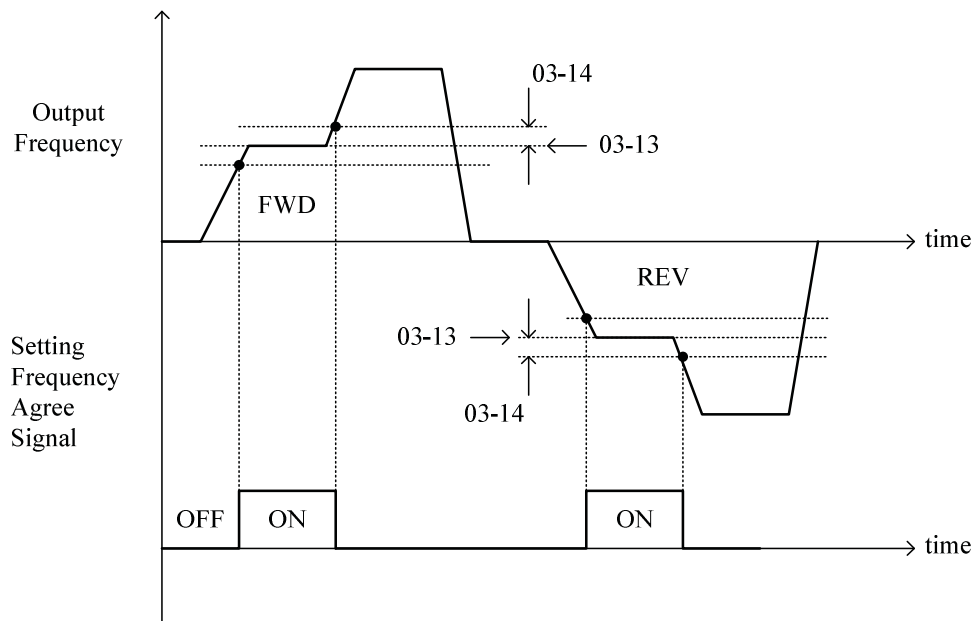

5) 03-11= **[4]** . RY1 will be on as soon as the output frequency > Frequency reached, preset by 03-13.

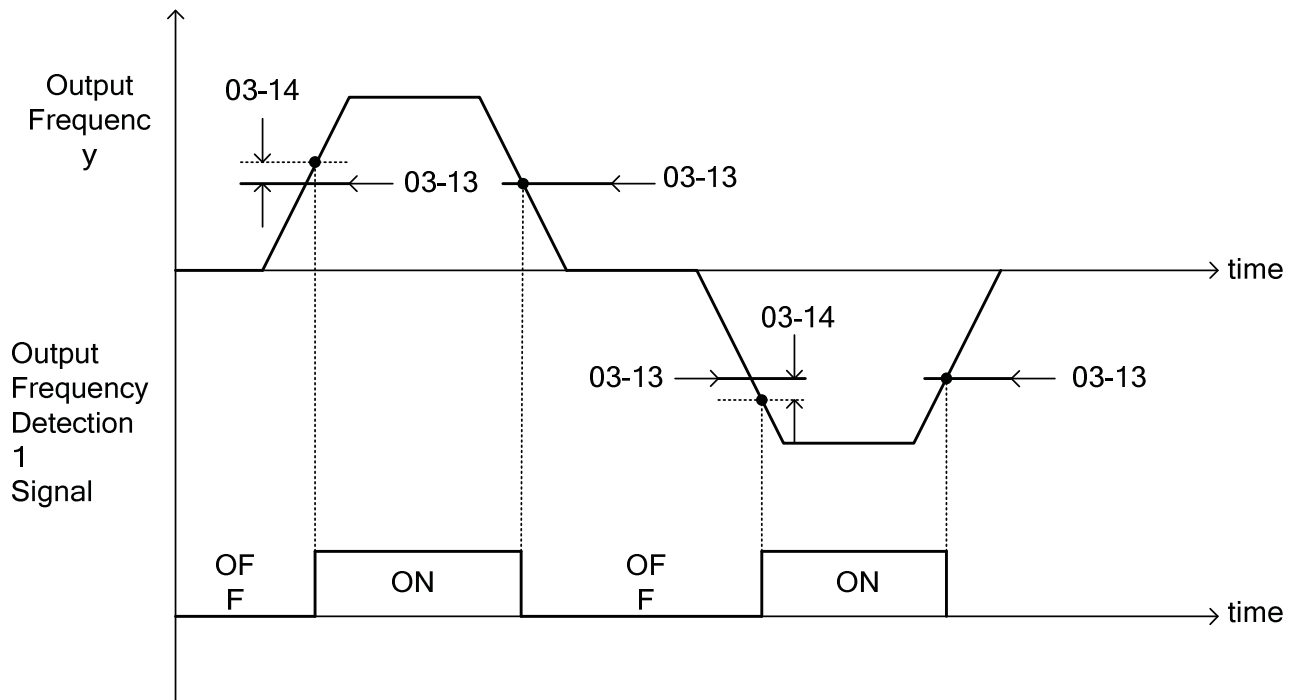

6) 03-11= **[5]** . RY1 will be on as soon as the output frequency < Frequency reached, preset by 03-13.

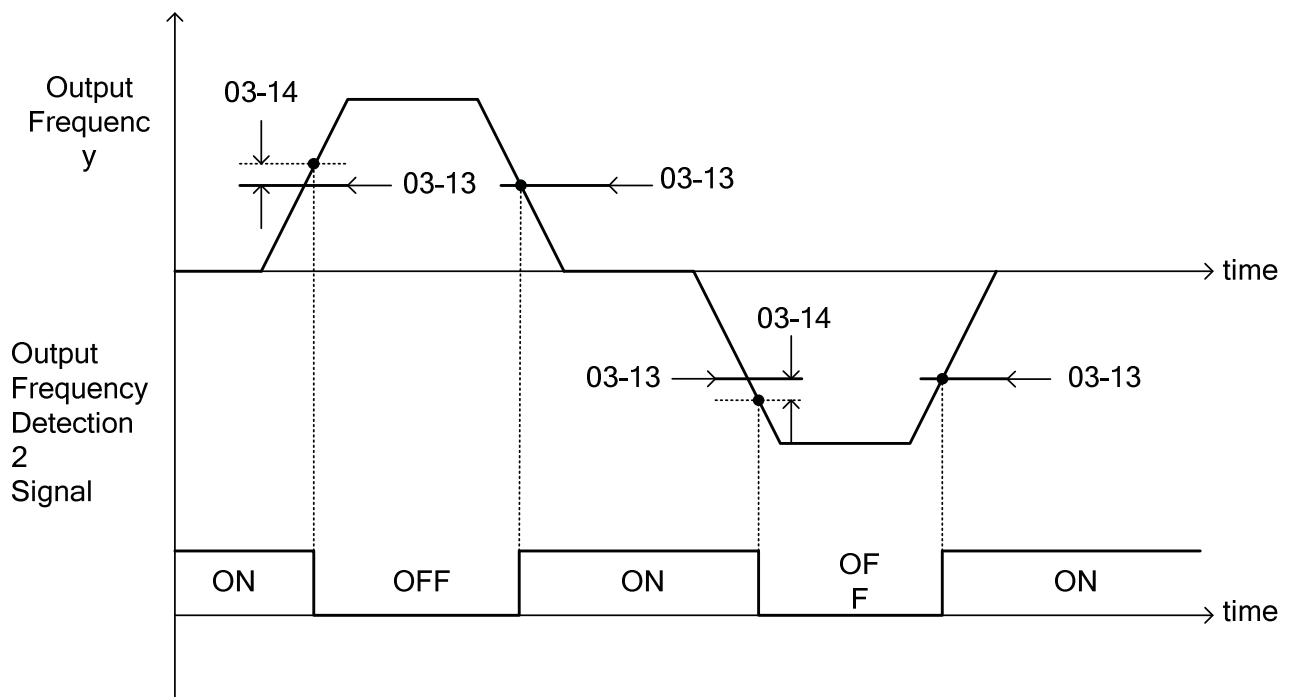

03-15	Output current Reached Preset
Range	[0.1~15.0] A
03-16	Output current detection time
Range	[0.1~10.0] s

- 03-11= **[13]** .RY1 will be on as soon as the output current detection value > Preset level in 03-15.
- 03-15: Setting range (0.1~15.0 Amps) as required according to the rated motor current.
- 03-16: Setting range (0.1~10.0) unit: seconds.

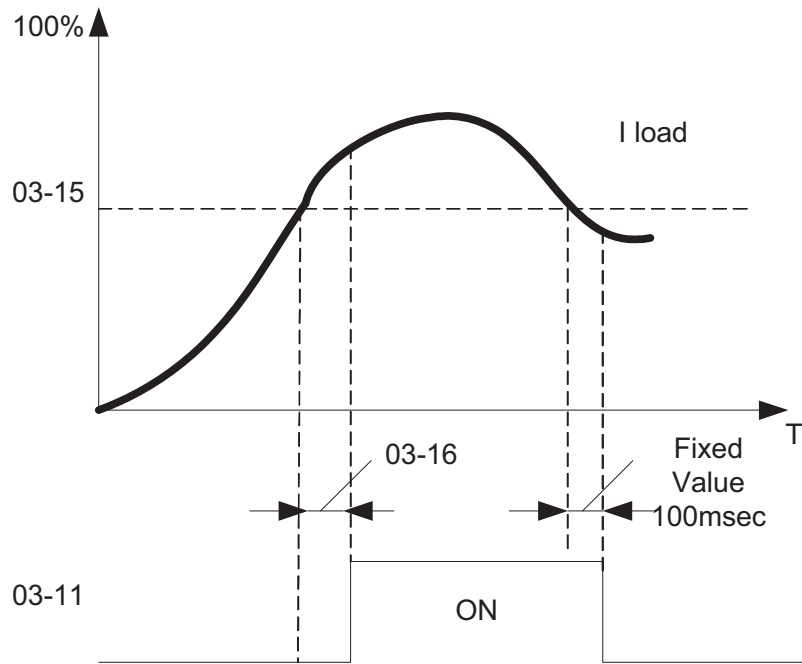

03-17	Brake Release Level
Range	【0.00~20.00】 Hz
03-18	Brake Engage Level
Range	【0.00~20.00】 Hz

- If 03-11 = **【14】**
- In accelerating mode, RY1 will be ON as soon as the actual output frequency reaches the external Brake release level set in parameter 03-17.
- In decelerating mode, RY1 will be OFF as soon as the actual output frequency reaches the external Brake engage level set in parameter 03-18.

Timing diagram for 03-17 < 03-18 is shown below:

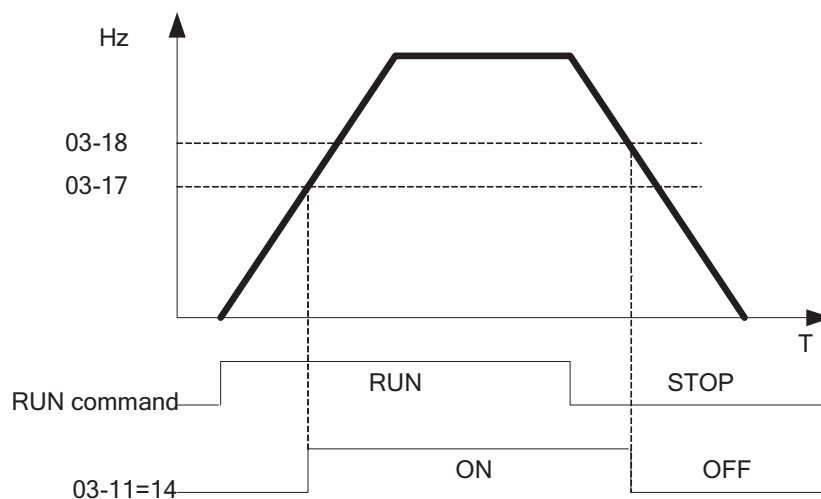

Timing diagram for 03-17 > 03-18 is shown below:

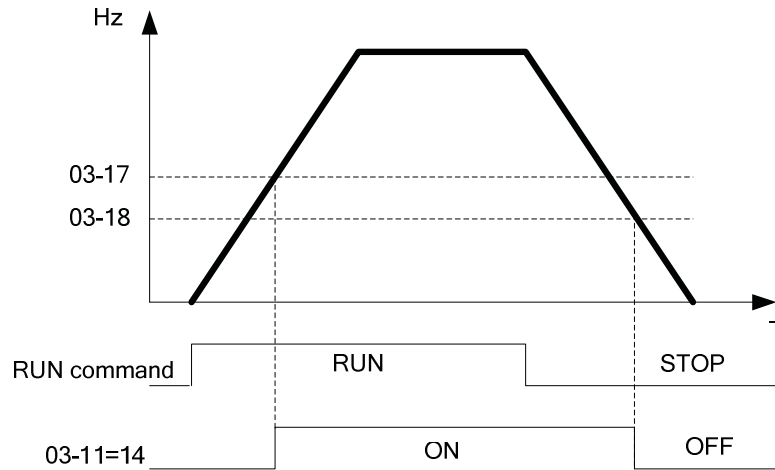

03- 19	Relay Output Status type
Range	【0】 :A (Normally open) 【1】 :B (Normally close)

04- External analog signal input / output functions

04- 00	Analog Voltage & Current input selections	
Range	AVI	ACI
	【0】 :0~10V	0~20mA
	【1】 :0~10V	4~20mA
	【2】 :2~10V	0~20mA
	【3】 :2~10V	4~20mA

➤ **Analog Input Scaling formulas:-**

■ **Current Input mode**

$$AI (0\sim 20mA) : F (Hz) = \frac{I (mA)}{20(mA)} \times (00 - 12)$$

$$AI (4\sim 20mA) : F (Hz) = \frac{I - 4(mA)}{20 - 4(mA)} \times (00 - 12), I \geq 4$$

■ **Voltage Input Mode**

$$AI (0\sim 10V) : F (Hz) = \frac{V(v)}{10(v)} \times (00 - 12)$$

$$AI (2\sim 10V) : F (Hz) = \frac{V - 2(v)}{10 - 2(v)} \times (00 - 12), V \geq 2$$

04- 01	AVI signal verification Scan Time
Range	【1~200】 1m s
04- 02	AVIGain
Range	【0 ~ 1000】 %
04- 03	AVI Bias
Range	【0~ 100】 %
04- 04	AVI Bias Selection
Range	【0】 : positive 【1】 : Negative
04- 05	AVI Slope
Range	【0】 : positive 【1】 : Negative
04- 06	ACI signal verification Scan Time
Range	【1~200】 1m s
04- 07	ACIGain
Range	【0 ~ 1000】 %
04- 08	ACI Bias
Range	【0 ~ 100】 %
04- 09	ACI Bias Selection
Range	【0】 : positive 【1】 : Negative
04-10	ACI Slope
Range	【0】 : positive 【1】 : Negative

➤ Set 04- 01 and 04- 06 for Analog signal verification.
 Inverter reads the average values of A/D signal once per (04- 01/04- 06 x 1ms).
 Set scan intervals according to the application and with consideration for signal instability or interference effects on the signal by external sources. Long scan times will result in slower response time.

AVI. Analog Voltage input scaling examples by adjusting Gain, Bias & Slope parameters (04-02~04-05).

(1) Positive Bias type (04-04= 0) and effects of modifying Bias amount by parameter 04-03 and Slope type with parameter 04-05 are shown in Fig 1&2.

Diagram 1.

	04- 02	04- 03	04- 04	04- 05
A	100%	50%	0	0
B	100%	0%	0	0

Diagram 2.

	04- 02	04- 03	04- 04	04- 05
C	100%	50%	0	1
D	100%	0%	0	1

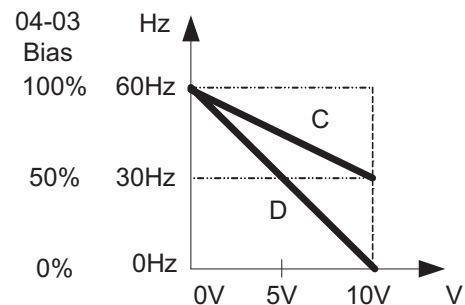
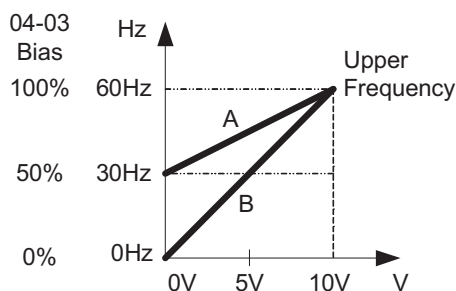

(2) Negative Bias type and effects of modifying Bias amount by parameter 04-03 and Slope type with parameter 04-05 are shown in Fig 3&4.

Diagram 3:

	04- 02	04- 03	04- 04	04- 05
E	100%	20%	1	0

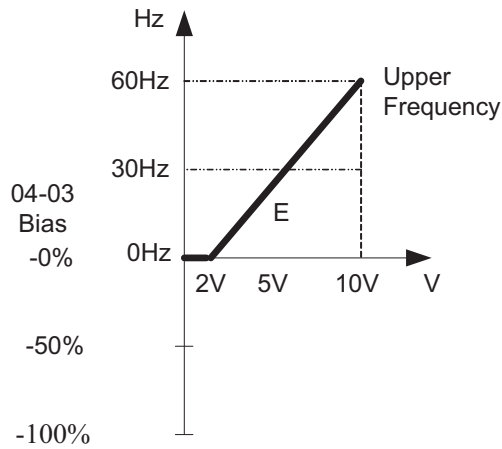
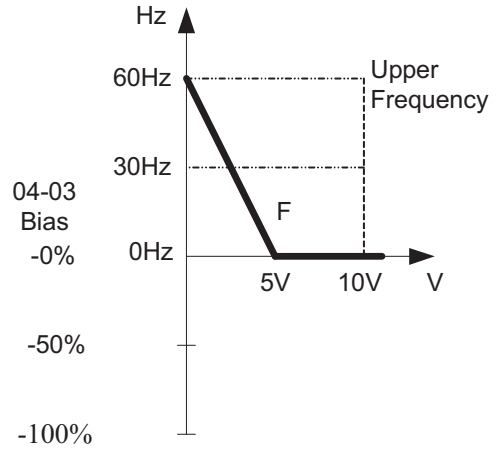

Diagram 4:

	04- 02	04- 03	04- 04	04- 05
F	100%	50%	1	1



(3) Offset bias set to 0% (04-03) and effect of modifying Analog Gain (04-02), Bias type (04-04) and slope type(04-05) are shown in shown Fig 5&6.

Diagram 5

	04- 02	04- 03	04- 04	04- 05
A'	50%	0%	0/1	0
B'	200%	0%	0/1	0

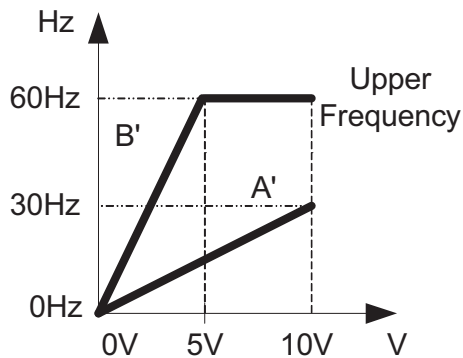
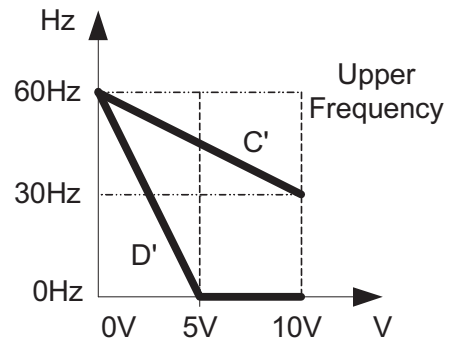

Diagram 6

	04- 02	04- 03	04- 04	04- 05
C'	50%	0%	0/1	1
D'	200%	0%	0/1	1



(4) Various other examples of analog input scaling and modification are shown in following figures 7,8,9 & 10.

Diagram 7

	04- 02	04- 03	04- 04	04- 05
a	50%	50%	0	0
b	200%	50%	0	0

Diagram 8

	04- 02	04- 03	04- 04	04- 05
c	50%	50%	0	1
d	200%	50%	0	1

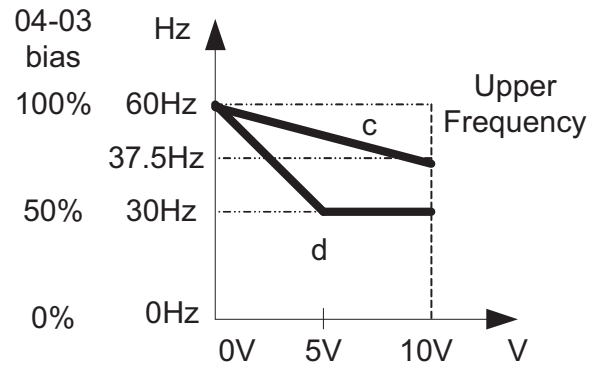
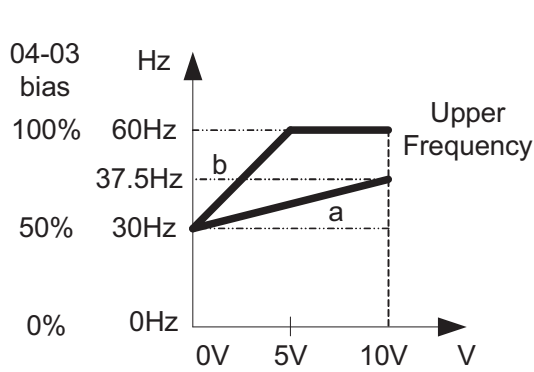
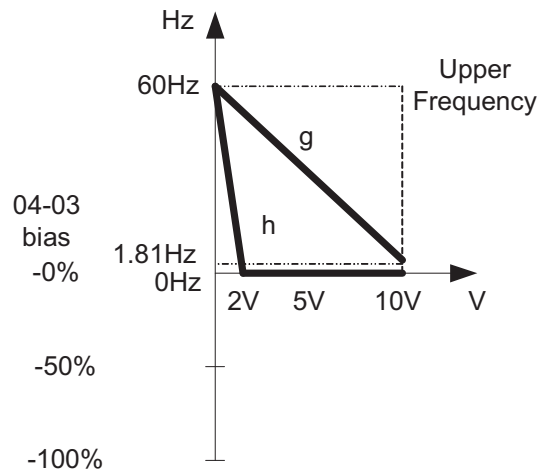
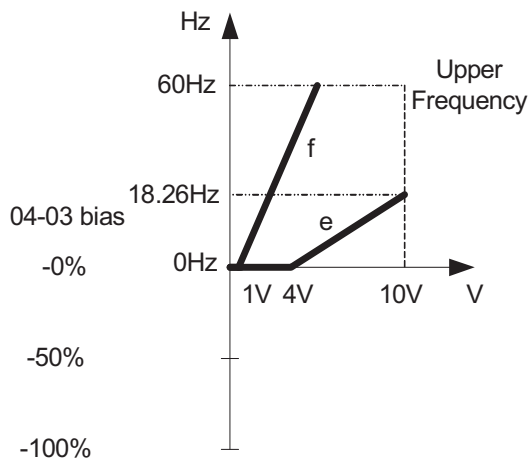

Diagram 9

	04- 02	04- 03	04- 04	04- 05
e	50%	20%	1	0
f	200%	20%	1	0

Diagram 10

	04- 02	04- 03	04- 04	04- 05
g	50%	50%	1	1
h	200%	0%	0	1



04-11	Analog Output (AO) function selection.
Range	<p>【0】 :Output frequency</p> <p>【1】 :Frequency Setting</p> <p>【2】 :Output voltage</p> <p>【3】 :DC Bus Voltage</p> <p>【4】 :Output current</p>

Example: Set 04-11 required according to the following table.

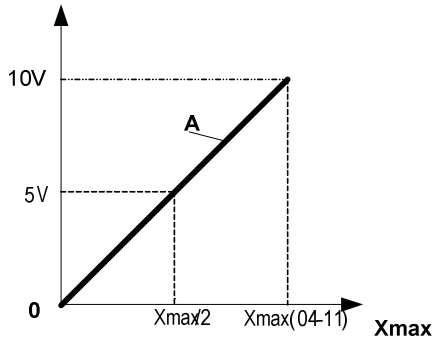

04-11	A	Xmax
【0】	Output frequency	upper frequency limit
【1】	Frequency Setting	upper frequency limit
【2】	Output voltage	Motor Rated Voltage
【3】	DC Bus Voltage	220V: 0~400V
【4】	Output current	2 times rated current of inverter

04-12	AO Gain
Range	【0 ~ 1000】 %
04-13	AO Bias
Range	【0 ~ 100】 %
04-14	AO Bias Selection
Range	【0】 : positive 【1】 : Negative
04-15	AO Slope
Range	【0】 : positive 【1】 : Negative

- Select the analog output type for the multifunction analog output on terminal (TM2) as required by parameter 04-11. Output format is 0-10V dc. The output voltage level can be scaled and modified by parameters 04-12 to 04-15 if necessary.
- The modification format will be same as the examples shown previously for Analog Voltage Input (AVI) parameters 4-02 to 4-05.

Note: the max output voltage is 10V due to the hardware of the circuit.
Use external devices that require a maximum of 10V dc signal.

05- Preset Frequency Selections.

05- 00	Preset Speed Control mode Selection
Range	【0】 :Common Accel / Decel. 【1】 : Individual Accel/Decel for each preset speed 0-7.

05- 01	Preset Speed 0 (Keypad Freq)
05- 02	Preset Speed 1
05- 03	Preset Speed 2
05- 04	Preset Speed 3
05- 05	Preset Speed 4
05- 06	Preset Speed 5
05- 07	Preset Speed 6
05- 08	Preset Speed 7
Range	【0.00 ~ 650.00】 Hz
05-17	Preset Speed 0 Acceleration time
05-18	Preset Speed 0 Deceleration time
05-19	Preset Speed 1 Acceleration time
05- 20	Preset Speed 1 Deceleration time
05- 21	Preset Speed 2 Acceleration time
05- 22	Preset Speed 2 Deceleration time
05- 23	Preset Speed 3 Acceleration time
05- 24	Preset Speed 3 Deceleration time
05- 25	Preset Speed 4 Acceleration time
05- 26	Preset Speed 4 Deceleration time
05- 27	Preset Speed 5 Acceleration time
05- 28	Preset Speed 5 Deceleration time

05- 29	Preset Speed 6 Acceleration time
05- 30	Preset Speed 6 Deceleration time
05- 31	Preset Speed 7 Acceleration time
05- 32	Preset Speed 7 Deceleration time
Range	【0.1 ~ 3600.0】 s

- When 05- 00 = **【0】** Accel /Decel 1 or 2 set by parameters 00-14/00-15 or 00-16/00-17 apply to all speeds.
- When 05- 00 = **【1】** Individual Accel/Decel apply to each preset speed 0-7. Parameters 05-17 to 05-32.
- Formula for calculating acceleration and deceleration time:

$$\text{Actual Acc time} = \frac{\text{Time of Accel1 or 2 x Preset Frequency}}{\text{Max Frequency}}$$

$$\text{Actual Dec time} = \frac{\text{Time of Accel1 or 2 x Preset Frequency}}{\text{Max Frequency}}$$

- Maximum output frequency = parameter 01-02 when programmable V/F is selected by 01- 00= **【7】** .
- Maximum output frequency = 50.00 hz or 60.00 hz when preset V/F patterns are selected. 01-00≠ **【7】** .

Example 01- 00≠ 7 , 01- 02= 50 hz, 05- 02= 10 hz (preset speed1),
05-19= 5 s(Accel time), 05-20= 20 s (Decel time)

$$\text{Preset speed 1 Actual Accel time} = \frac{(05-19) \times 10(\text{Hz})}{01-02} = 1(\text{s})$$

$$\text{Preset speed 1 Actual Deccel time} = \frac{(05-20) \times 10(\text{Hz})}{01-02} = 4(\text{s})$$

- **Multi speed run/stop cycles with Individual accel/decal times. 05-00= 【1】**
- Two modes are shown below:-
- Mode1 = On/Off run command
- Mode2= Continuous run command

Mode1 Example: 00- 02= **【1】** (External Run/Stop Control).

00- 04= **【1】** (Operation Mode : Run/stop-forward/reverse).

S1: 03- 00= **【0】** (RUN/STOP);

S2: 03- 01= **【1】** (Forward/Reserve);

S3: 03- 02= **【2】** (Preset speed 1);

S4: 03- 03= **【3】** (Preset speed 2);

S5: 03- 03= **【4】** (Preset speed 4);

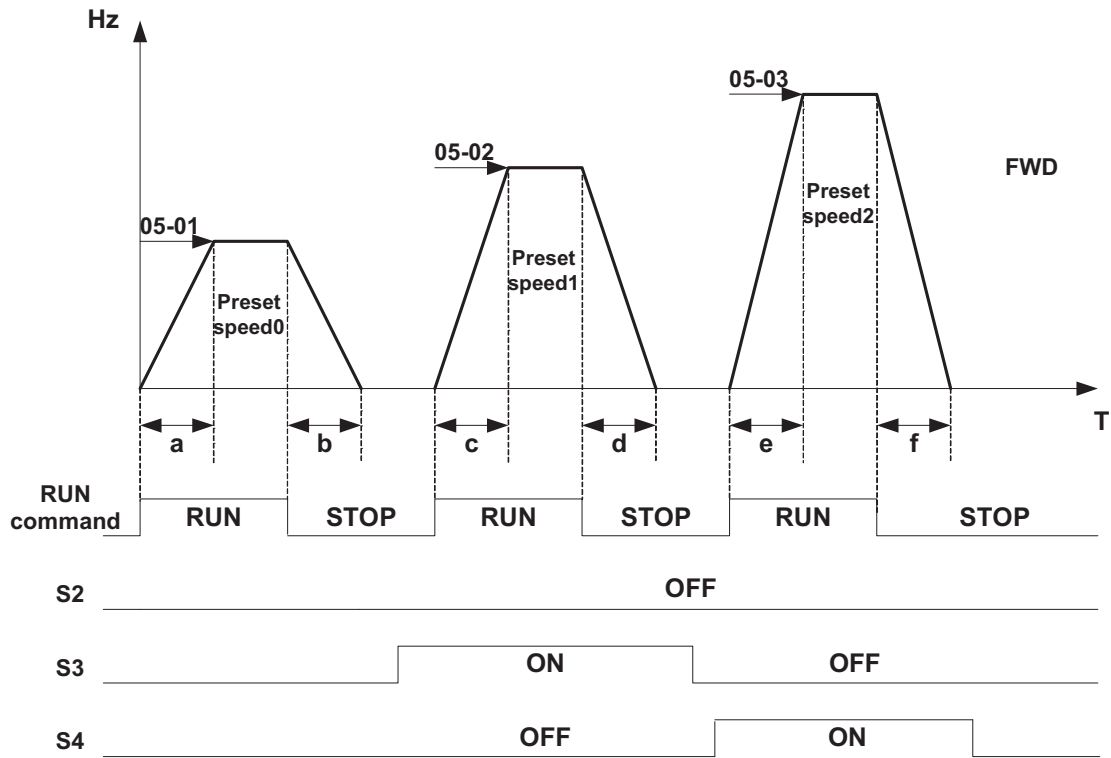

When the run command is On/Off, acceleration and deceleration times for each cycle can be calculated as below:- time unit is in seconds'.

$$a = \frac{(05-17) \times (05-01)}{01-02}, b = \frac{(05-18) \times (05-01)}{01-02}, c = \frac{(05-19) \times (05-02)}{01-02}, d = \frac{(05-20) \times (05-02)}{01-02} \dots$$

- **Mode2 Example.** Continuous run command.
- Set S1 for Continuous Run
- Set S2 For Forward /Reverse direction selection
- Set multi function terminals S3,S4 & S5 for setting three different preset speeds

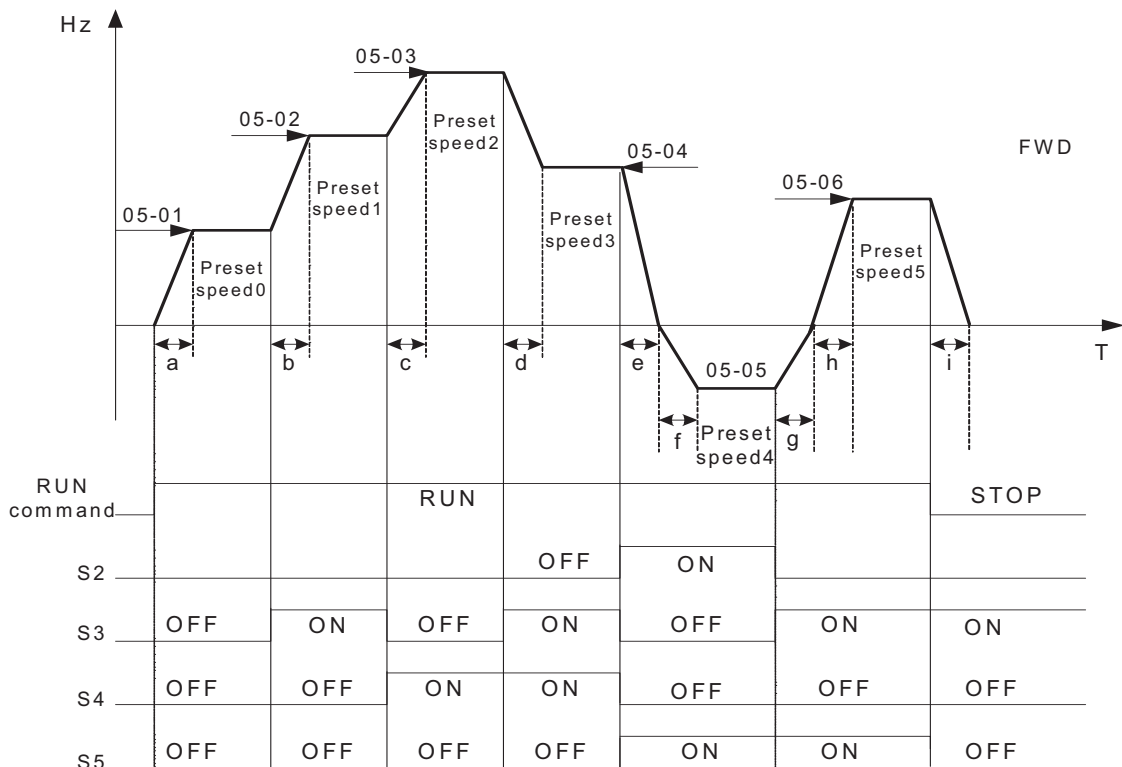

When the run command is continuous, acceleration and deceleration times for each segment can be calculated as below:-

$$\text{Ex] } a = \frac{(05-17) \times (05-01)}{01-02}, b = \frac{(05-19) \times [(05-02) - (05-01)]}{01-02}$$

$$c = \frac{(05-21) \times [(05-03) - (05-02)]}{01-02}, d = \frac{(05-24) \times [(05-03) - (05-04)]}{01-02}$$

$$e = \frac{(05-26) \times (05-05)}{01-02}, f = \frac{(05-28) \times (05-05)}{01-02}, g = \frac{(05-27) \times (05-05)}{01-02}$$

$$h = \frac{(05-29) \times (05-05)}{01-02}, i = \frac{(05-32) \times (05-05)}{01-02} \dots \text{Unit(sec)}$$

06- Auto Run(Auto Sequencer) function

06- 00	Auto Run(sequencer) mode selection
Range	<p>【0】 :Disabled</p> <p>【1】 :Single cycle (Continues to run from the unfinished step if restarted).</p> <p>【2】 :Periodic cycle. (Continues to run from the unfinished step if restarted).</p> <p>【3】 :Single cycle, then holds the speed of final step to run. (Continues to run from the unfinished step if restarted).</p> <p>【4】 :Single cycle. (Starts a new cycle if restarted).</p> <p>【5】 :Periodic cycle. (Starts a new cycle if restarted).</p> <p>【6】 :Single cycle, then hold the speed of final step to run. (Starts a new cycle if restarted).</p>

Frequency of the step 0 is set by parameter 05-01 keypad Frequency.

06- 01	Auto _ Run Mode Frequency Command 1
06- 02	Auto _ Run Mode Frequency Command 2
06- 03	Auto _ Run Mode Frequency Command 3
06- 04	Auto _ Run Mode Frequency Command 4
06- 05	Auto _ Run Mode Frequency Command 5
06- 06	Auto _ Run Mode Frequency Command 6
06- 07	Auto _ Run Mode Frequency Command 7
Range	【0.00 ~ 650.00】 Hz

06- 16	Auto _ Run Mode Running Time Setting0
06- 17	Auto _ Run Mode Running Time Setting1
06- 18	Auto _ Run Mode Running Time Setting2
06- 19	Auto _ Run Mode Running Time Setting3
06- 20	Auto _ Run Mode Running Time Setting4
06- 21	Auto _ Run Mode Running Time Setting5
06- 22	Auto _ Run Mode Running Time Setting6
06- 23	Auto _ Run Mode Running Time Setting7
Range	【0.00 ~ 3600.0】 s

06- 32	Auto_ Run Mode Running Direction0
06- 33	Auto_ Run Mode Running Direction1
06- 34	Auto_ Run Mode Running Direction2
06- 35	Auto_ Run Mode Running Direction3
06- 36	Auto_ Run Mode Running Direction4
06- 37	Auto_ Run Mode Running Direction5
06- 38	Auto_ Run Mode Running Direction6
06- 39	Auto_ Run Mode Running Direction7
Range	【0】 : STOP 【1】 : forward 【2】 : reverse

- Auto Run sequencer mode has to be enabled by using one of the multifunctional inputs S1 to S5 and setting the relevant parameter 03-00 to 03-04 to selection **【18】** .
- Various Auto Run (sequencer) modes can be selected by parameter (06-00) as listed above.
- 7 Auto Run (sequencer) modes can be selected by parameters (06-01~06-39)
- Auto Run frequency commands1 to 7 are set with Parameters (06-01 ~ 06-07),
- Sequence run times are set with parameters (06-17 ~ 06-23)
- FWD/REV Direction for each sequence can be set with parameters (06-33 ~ 06-39).
- Auto sequence 0, frequency is set from keypad by parameter 05-01, sequence run time and direction are set by parameters 06-16 and 06-32.

Auto RUN (Auto Sequencer) examples are shown in the following pages:-

Example 1. Single Cycle (06- 00=1,4)

The inverter will run for a single full cycle based on the specified number of sequences, then it will stop. In this example 4 sequences are set, three in forward direction and one in Reverse.

Auto Run Mode. 06- 00= **【1】** or **【4】** ,

Frequency 05- 01= **【15】** Hz, 06- 01= **【30】** Hz, 06- 02= **【50】** Hz, 06- 03= **【20】** Hz

Sequence Run Time 06-16= **【20】** s, 06-17 = **【25】** s, 06-18= **【30】** s, 06-19= **【40】** s,

Direction 06-32= **【1】** FWD, 06-33 = **【1】** FWD, 06-34= **【1】** (FWD), 06-35= **【2】** (REV)

Unused Sequence Parameters 06-04~ 06-07= **【0】** Hz , 06-20~06-23= **【0】** s , 06-36~06-39= **【0】**

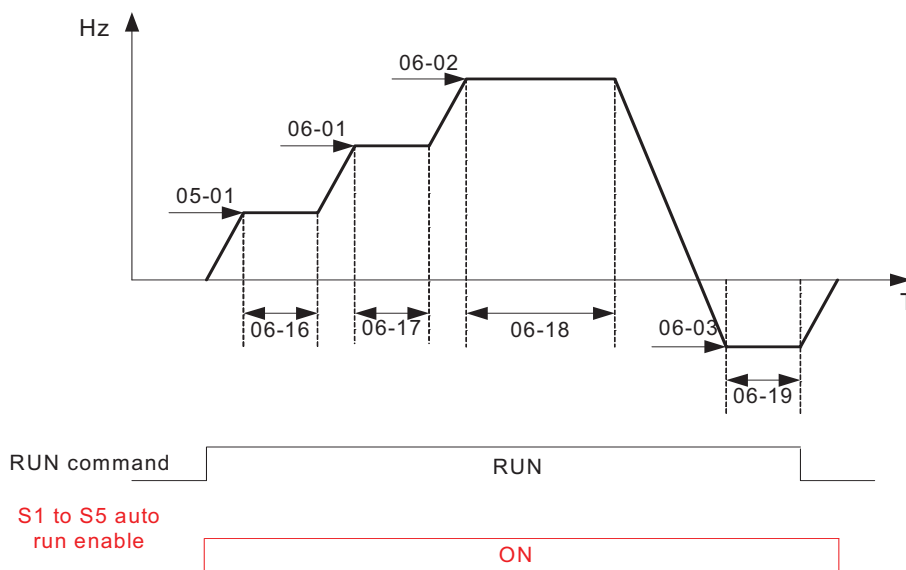

Example 2. Periodic cycle Run.

Mode: 06- 00= **[2]** or **[5]**

The inverter will repeat the same cycle periodically.

All other Parameters are set same as Example 1. shown above.

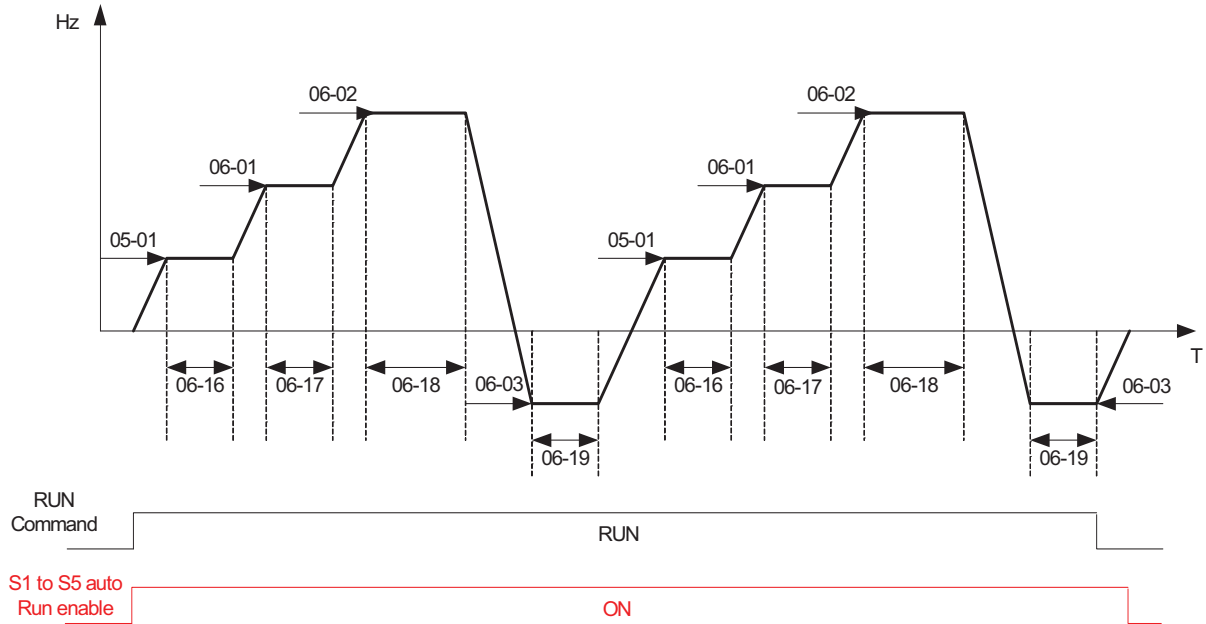

Example 3. Auto_Run Mode for Single Cycle 06-00= [3 or 6]

The speed of final step will be held to run.

Auto Run Mode. 06- 00 = **[3]** or **[6]**

Frequency 05- 01 = **[15]** Hz, 06- 01= **[30]** Hz, 06- 02= **[50]** Hz, 06- 07= **[20]** Hz,

Sequence Run Time 06-16 = **[20]** s, 06-17= **[25]** s, 06-18= **[30]** s, 06-23= **[40]** s,

Direction 06-32 = **[1]** FWD 06-33= **[1]** , 06-34 = **[1]** , 06-39= **[1]** ,

Unused Sequence Parameters 06-03~06- 06= **[0]** Hz, 06-19~06-22= **[0]** s, 06-35~06-38 = **[0]**

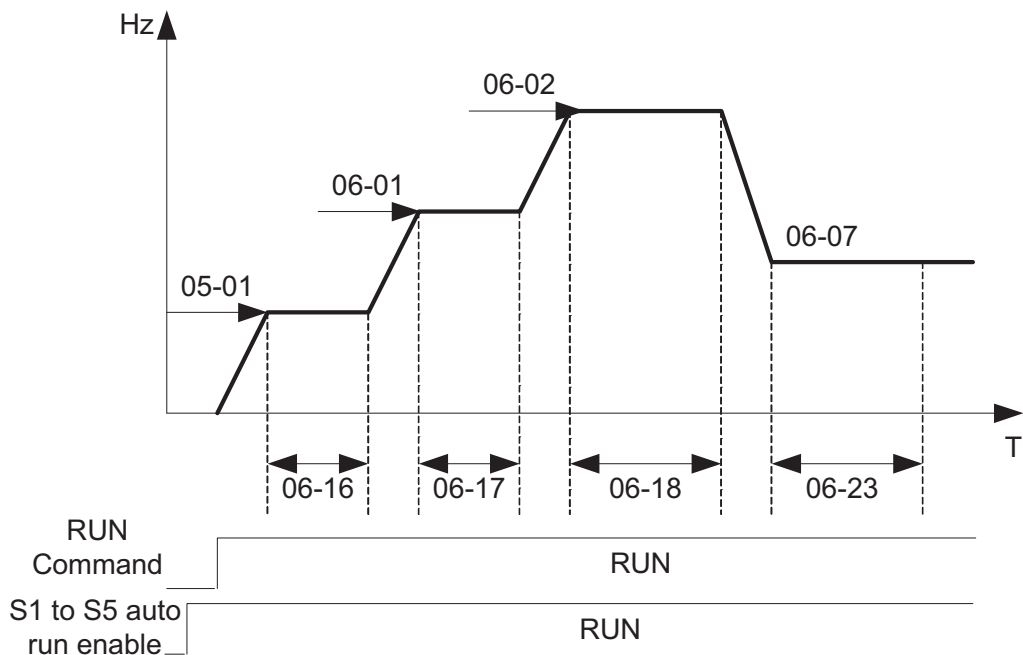

Example 4&5 .

Auto Run Mode 06-00= 【1~3】 . After a restart continues to run from the unfinished step.

Auto Run Mode 6- 00= 【4~6】 . After a restart, it will begin a new cycle.

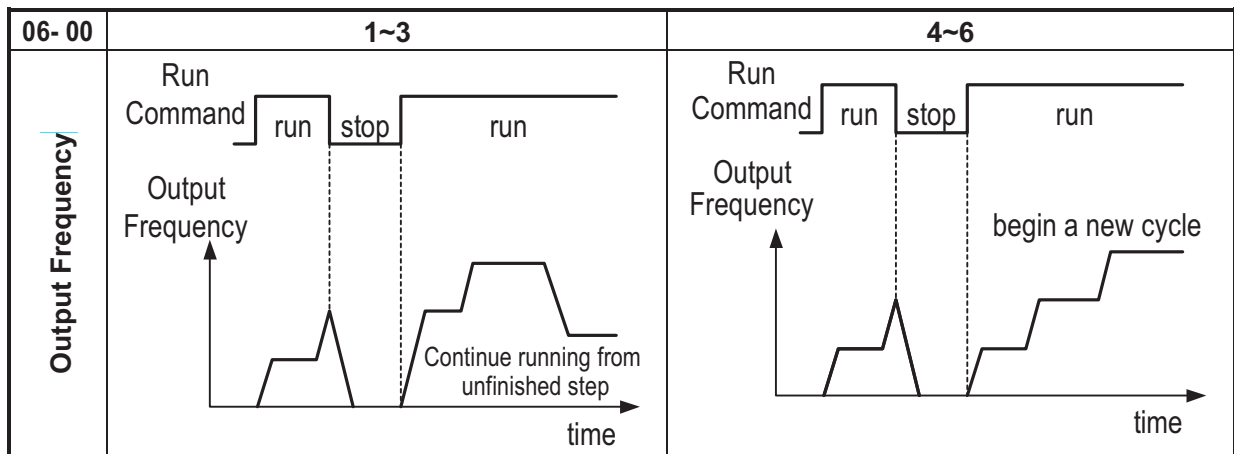

- ACC/DEC time in Auto run mode will be according to the setting of 00-14/00-15 or 00-16/00-17.
- For Auto sequence 0.The run frequency will be according to keypad frequency set by parameter 05-01.Parameters 06-16 and 06-32 are used to set the sequence Run time and Run direction.

07- Start/Stop command setup	
07- 00	Momentary power loss and restart
Range	【0】 :Momentary Power Loss and Restart disable 【1】 :Momentary power loss and restart enable

- If the input power supply due to sudden increase in supply demand by other equipment results in voltage drops below the under voltage level, the inverter will stop its output at once.
- When 07-00 = 【0】 .On power loss, the inverter will not start.
- When 07-00 = 【1】 .After a momentary power loss, inverter will restart with the same frequency before power loss, and there is no limitation on number of restarts.
- On power loss, as long as the inverter CPU power is not completely lost, the momentary power loss restart will be effective, restart will be according to setting of parameters 00-02 & 07-04 and status of External run switch.

Caution:- After any power loss if the Run mode is set to External by parameter 00-02=1 and if Direct start on power up is also selected by parameter 07-04=0, please note that the inverter will run on resumption of power.

To ensure safety of operators and to avoid any damages to the machinery, all necessary safety measure must be considered, including disconnection of power to the inverter.

07- 01	Auto Restart Delay Time
Range	【0.0~800.0】 s
07- 02	Number of Auto Restart Attempts
Range	【0~10】

- 07- 02= 【0】 : The inverter will not auto restart after trips due to fault.
- 07- 02> 【0】 , 07- 01= 【0】 .After a trip due to fault the inverter will run with the same frequency before power loss, and restarts after an internal delay of 0.5 seconds.
- 07- 02> 【0】 , 07- 01> 【0】 , After a fault trip the inverter will run with the same frequency before power loss, and restart with a delay according the preset in parameter 07-01.
- **Note:- Auto restart after a fault will not function while DC injection braking or decelerating to stop**

07- 03	Reset Mode Setting
Range	【0】 :Enable Reset Only when Run Command is Off 【1】 :Enable Reset when Run Command is On or Off

- 07-03=0 Once the inverter is detected a fault, please turn Run switch Off and then On again to perform reset, otherwise restarting will not be possible.

07- 04	Direct Running on Power Up
Range	【0】 :Enable Direct running after power up 【1】 :Disable Direct running after power up
07- 05	Delay-ON Timer (Seconds)
Range	【1.0~300.0】 s

- When direct run on power up is selected by 07-04=0 and the inverter is set to external run by (00-02/00-03=1), if the run switch is ON as power is applied, the inverter will auto start. It is recommend that the power is turned off and the run switch is also off to avoid possibility of injury to operators and damage to machines as the power is reapplied.

Note: IF this mode is required all safety measures must be considered including warning labels.

- When direct run on power up is disabled by 07-04=1 and if the inverter is set to external run by (00-02/00-03=1), if the run switch is ON as power is applied, the inverter will not auto start and the display will flash with STP1. It will be necessary to turn OFF the run switch and then ON again to start normally.

07- 06	DC Injection Brake Start Frequency (Hz)
Range	【0.10 ~ 10.00】 Hz
07- 07	DC Injection Brake Level (%)
Range	【0~ 20】 %
07- 08	DC Injection Brake Time (Seconds)
Range	【0.0 ~ 25.5】 s

- 07- 08/07- 06 set the DC injection brake duration and the brake start frequency as shown below.

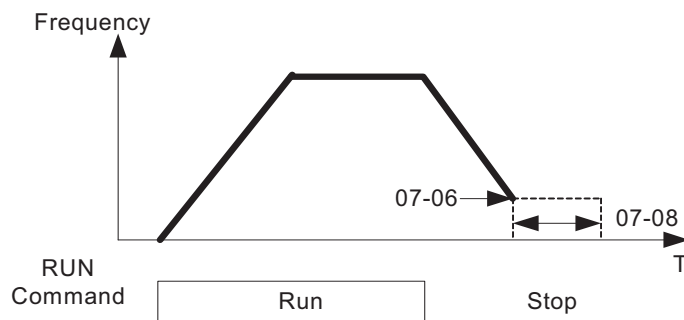

07- 09	Stopping Method
Range	【0】 :Deceleration to stop. 【1】 :Coast to stop.

- 07- 09 = **【0】** : after receiving stop command, the motor will decelerate to stop according to setting of 00-15, deceleration time 1.
- 07- 09 = **【1】** : after receiving stop command, the motor will free-run (Coast) to stop.

08- Protection function group	
08- 00	Trip Prevention Selection
Range	【xxxx0】 :Enable Trip Prevention During Acceleration 【xxxx1】 :Disable Trip Prevention During Acceleration 【xxx0x】 :Enable Trip Prevention During Deceleration 【xxx1x】 :Disable Trip Prevention During Deceleration 【xx0xx】 :Enable Trip Prevention in Run Mode 【xx1xx】 :Disable Trip Prevention in Run Mode 【x0xxx】 :Enable over voltage Prevention in Run Mode 【x1xxx】 :Disable over voltage Prevention in Run Mode

08- 01	Trip Prevention Level During Acceleration
Range	【50 ~ 200】 %

- Trip prevention adjustment level during acceleration to prevent over current (OC-A) trips.
- If trip prevention during acceleration is enabled and an over current occurs due to the load, then the acceleration is interrupted until the over current level is dropped below the setting in 08-01 then the acceleration is resumed.

08- 02	Trip Prevention Level During Deceleration
Range	【50 ~ 200】 %

- Trip prevention adjustment level during deceleration to prevent over Voltage (OV-C) trips.
- If trip prevention during deceleration is enabled and an over voltage occurs during stopping due to the load, then the deceleration is interrupted until the over voltage level is dropped below the setting in 08-02 then the deceleration is resumed.

08- 03	Trip Prevention Level during continuous Run Mode
Range	【50 ~ 200】 %

- Trip prevention adjustment level during continuous Run to prevent over current (OC-C) trips.
- If trip prevention during continuous Run is enabled and an over current occurs due the load such as a sudden transient load, then the output frequency is reduced by decelerating to a lower speed until the over current level is dropped below the preset in 08-03, then the output frequency accelerates back to the normal running frequency.

08- 04	Over voltage Prevention Level during Run Mode
Range	【350~390】 V

- Over voltage prevention level can be set by parameter 08-04 when necessary. When the DC bus voltage is higher than the level set in 08-04, the over voltage fault will occur.

08- 05	Electronic Motor Overload Protection Operation Mod (OL1)
Range	【0】 :Enable Electronic Motor Overload Protection 【1】 :Disable Electronic Motor Overload Protection

08- 06	Operation After Overload Protection is Activated
Range	【0】 :Coast-to-Stop After Overload Protection is Activated 【1】 :Drive Will Not Trip when Overload Protection is Activated (OL1)

- 08- 06 = **【0】** : On overload condition the inverter coast to stop as the thermal relay detects the overload and the display will flash OL1.To reset Press the 'Reset' key or use an external reset to continue to run.
- 08- 06 = **【1】** : On overload condition the inverter continues to run, display flash with OL1, until the current falls below the overload level.

The heat sinking function will not be as effective when the motor run at low speed. So the thermal action level will decline at the same time. (The curve 1 will change to curve 2)

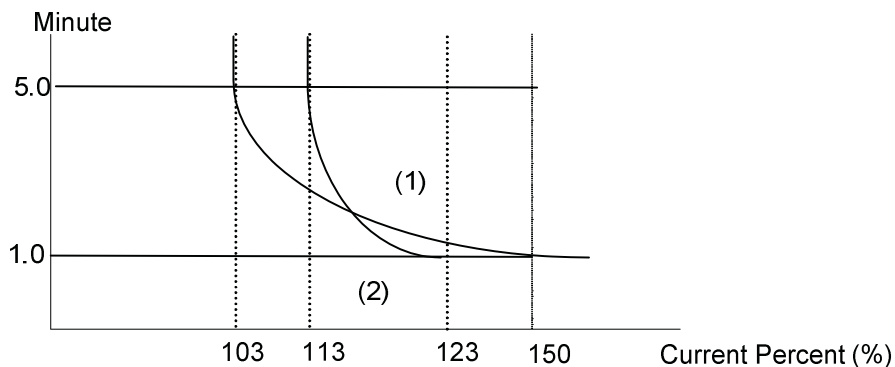

08- 07	OH over heat Protection
Range	【0】 :Auto (Depends on heat sink temp.) 【1】 :Operate while in RUN mode 【2】 :Always Run 【3】 :Disabled

- **08- 07= 【0】** : Cooling fan runs as the inverter detects temperature rise.
- **08- 07= 【1】** : Cooling fan runs while the inverter is running.
- **08- 07= 【2】** : Cooling fan runs continuously.
- **08- 07= 【3】** : Cooling fan is disabled.

08-08	AVR function
Range	<p>【0】 :AVR function enable</p> <p>【1】 :AVR function disable</p> <p>【2】 :AVR function disable for stop</p> <p>【3】 :AVR function disable for Deceleration</p> <p>【4】 :AVR function disabled for stop & Deceleration from one speed to another speed.</p> <p>【5】 :when VDC>360V , AVR function is disabled for stop and Deceleration</p>

- Automatic voltage regulator function provides a level of output voltage stability when there is input voltage instability. So when 08-08=0, Input voltage fluctuations will not effect the output voltage.
- 08-08=1. Input voltage fluctuations will cause fluctuations on output voltage.
- 08-08=2. AVR is disabled during stopping to avoid an increase in stopping time.
- 08-08=3. AVR is disabled only during deceleration from one speed to another speed. This will avoid longer than required deceleration time.

08-09	Input phase loss protection
Range	<p>【0】 :Disabled</p> <p>【1】 :Enabled</p>

When 08-09= **【1】** :On phase loss warning message PF is displayed.

09- Communication function group

09-00	Assigned Communication Station Number
Range	【1 ~ 32】

- 09-00 sets the communication station number when there are more that one unit on the communication network. Up to 32 Slave units can be controlled from one master controller such as a PLC.

09-01	RTU code /ASCII code Selection
Range	<p>【0】 :RTU</p> <p>【1】 :ASCII</p>
09-02	Baud Rate Setting (bps)
Range	<p>【0】 :4800</p> <p>【1】 :9600</p> <p>【2】 :19200</p> <p>【3】 :38400</p>
09-03	Stop Bit Selection
Range	<p>【0】 :1 stop bit</p> <p>【1】 :2 stop bit</p>
09-04	Parity Selection
Range	<p>【0】 :no parity</p> <p>【1】 : even parity</p> <p>【2】 : odd parity</p>

09- 05	Data Format Selection
Range	【0】 :8 bit data 【1】 :7 bit data

➤ Set 09-01~09-05 to configure communication format before starting communication.

09- 06	Communication time-out detection time
Range	【0.0~25.5】 s

09- 07	Communication time-out operation selection
Range	【0】 :Stop in deceleration time 1 and show COT after communication timeout 【1】 : Stop in free run mode and show COT after communication timeout 【2】 :Stop in deceleration time 2 and show COT after communication timeout 【3】 : Keep running and show COT after Communication timeout

➤ Time-out detection time: 00.0~25.5seconds; setting 00.0 seconds: disables time-out function.

09- 08	Err6 fault tolerance times
Range	【1~20】

➤ When communication error time ≥ 09-08 setting, keypad display shows ERR6.

09- 09	Drive Transmit Wait Time
Range	【5~65】 m s

➤ This parameter is used to set the converter to receive data from the sending date to the beginning of the time.

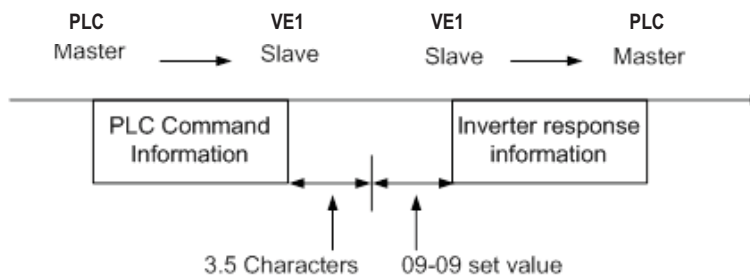

10-PID function Setup

PID block diagram

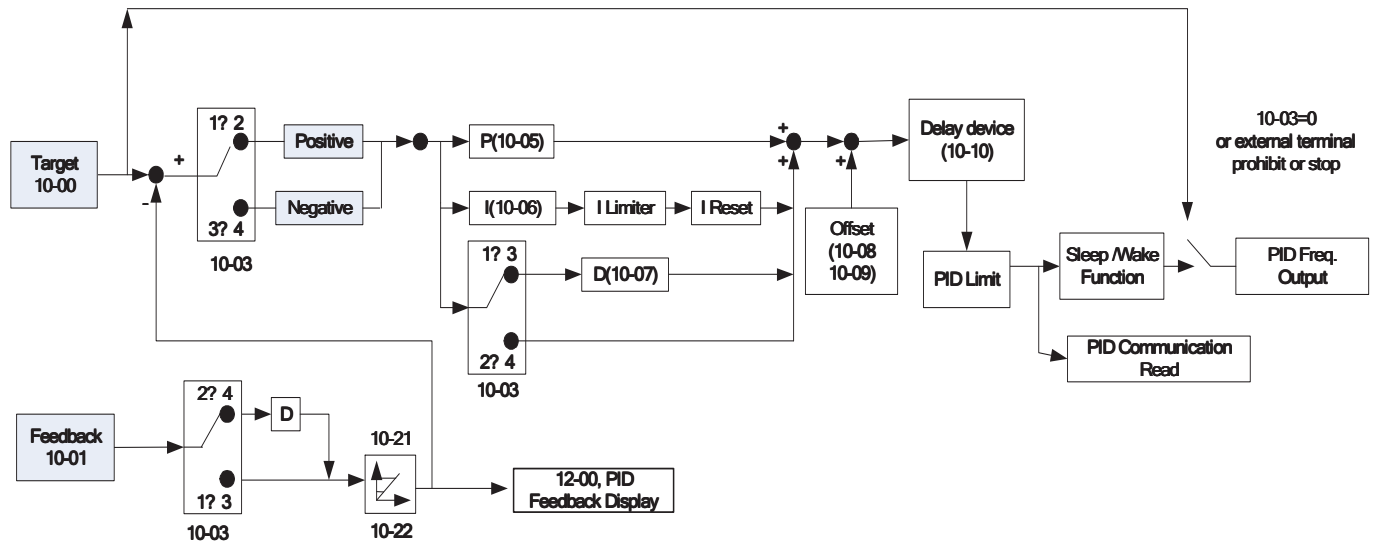

10- 00	PID target value selection
Range	【0】 :Potentiometer on Keypad 【1】 :External AVI Analog Signal Input 【2】 :External ACI Analog Signal Input 【3】 : Target Frequency set by Communication method. 【4】 : Set from keypad by parameter 10-02.

- 10-00 selections are only effective when frequency source selection is set to PID by parameters 00 - 05 \ 00 - 06= 6.

10- 01	PID feedback value selection
Range	【0】 :Potentiometer on Keypad 【1】 :External AVI Analog Signal Input 【2】 :External ACI Analog Signal Input 【3】 :Communication setting Frequency

- ! Note: 10-00 and 10-01 can not be set to the same value.

10- 02	PID keypad input
Range	【0.0~100.0】 %

10- 03	PID operation selection
Range	【0】 :PID Function disabled 【1】 : FWD Characteristic. Deviation is D-controlled 【2】 : FWD Characteristic. Feedback is D-controlled 【3】 : REV Characteristic. Deviation is D-controlled 【4】 : REV Characteristic. Feedback is D-controlled

- 10- 03 = **【1】** .

Deviation (target - detected value) is derivative controlled in unit time set in parameter 10-07.

- 10- 03 = **【2】**

Feedback (detected value) is derivative controlled in unit time set in parameter 10- 07.

- 10- 03 = **【3】**

Deviation (target value - detected value) is derivative controlled in unit time set in parameter 10-07. If the deviation is positive, the output frequency decreases, vice versa.

- 10- 03 = **【4】**

Feed back (detected value) is derivative controlled in unit time set in parameter 10- 07. If the deviation is positive, the output frequency decreases, vice versa.

Note:-

For 10-03 = 1 or 2, If the deviation is positive, the output frequency increases and, vice versa.

For 10-03 = 3 or 4, If the deviation is positive, the output frequency decreases, vice versa.

10- 04	Feedback Gain coefficient
Range	【0.00 ~ 10.00】

- 10-04 is the calibration gain. Deviation = set point – (feedback signal×10-04)

10-05	Proportional Gain
Range	【0.0 ~ 10.0】
➤ 10-05: Proportion gain for P control.	
10-06	Integral Time
Range	【0.0 ~ 100.0】 s
➤ 10-06: Integration time for I control	
10-07	Derivative Time
Range	【0.00 ~ 10.00】 s
➤ 10-07: Differential time for D control	
10-08	PID Offset
Range	【0】 : Positive Direction 【1】 : Negative Direction
10-09	PID Offset Adjust
Range	【0 ~ 109】 %
➤ 10-08 /10-09: Calculated PID output is offset by 10-09 (the polarity of offset is according to10-08)	
10-10	PID Output Lag Filter Time
Range	【0.0 ~ 2.5】 s
➤ 10-10 : Update time for output frequency.	
10-11	Feedback Loss Detection Mode
Range	【0】 :Disable 【1】 :Enable – Drive Continues to Operate After Feedback Loss 【2】 :Enable – Drive “STOPS” After Feedback Loss
➤ 10-11= 【1】 : On feed back loss detection, continue running, and display ‘PDER’;	
➤ 10-11= 【2】 : On feed back loss detection, stop, and display ‘PDER’.	
10-12	Feedback Loss Detection Level
Range	【0 ~ 100】
➤ 10-12 is the level for signal loss. Error = (Set point – Feedback value). When the error is larger than the loss level setting, the feedback signal is considered lost.	
10-13	Feedback Loss Detection Delay Time
Range	【0.0 ~25.5】 s
➤ 10-13:The minimum time delay before feedback signal loss is determined.	
10-14	Integration Limit Value
Range	【0 ~ 109】 %
➤ 10-14: the Limiter to prevent the PID from saturating.	
10-15	Integration Value Resets to Zero when Feedback Signal Equals the target Value
Range	【0】 : Disabled 【1】 : After 1 s 【30】 : After 30 s (Range:- 1 ~ 30 s)
➤ 10-15=0.As PID feedback value reaches the set point, the integral value will not be reset.	
➤ 10-15= 1~30.As PID feedback value reaches the set point, reset to 0 in 1~30 seconds and inverter stops. The inverter will run again when the feedback value differs from the set point value.	

10-16	Allowable Integration Error Margin (Unit) (1 Unit = 1/8192)
Range	【0 ~ 100】 %

➤ 10-16 = 0 ~ 100% unit value: Restart the tolerance after the integrator reset to 0.

10-17	PID Sleep Frequency Level
Range	【0.00~650.00】 Hz
10-18	PID Sleep Function Delay Time
Range	【0.0 ~25.5】 s
10-19	PID Wake up frequency Level
Range	【0.00 ~ 650.00】 Hz
10-20	PID Wake up function Delay Time
Range	【0.0 ~ 25.5】 s

- When PID output frequency is less than the sleep threshold frequency and exceeds the time of sleep delay, the inverter will decelerate to 0 and enters PID sleep mode.
- When PID output frequency is larger than the Wake up threshold frequency inverter will enter the PID mode again as shown in the timing diagram below.

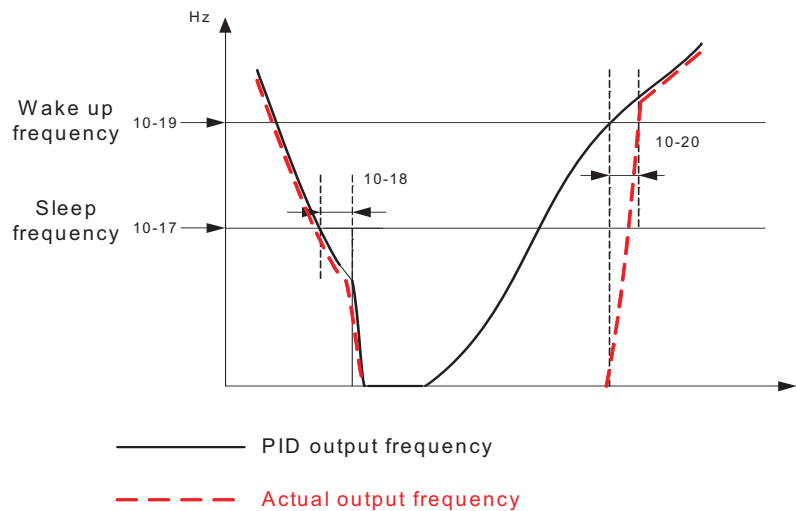

10-21	Max PID Feedback Level.
Range	【0 ~ 999】
10-22	Min PID Feedback Level.
Range	【0 ~ 999】

➤ Example: If 10-21=100 and 10-22=50 and the unit for the range from 0 to 999 will be defined with the parameters setting of 12-02, actual feedback value variation range, will be scaled to 50 and 100 only for display, as Shown below.

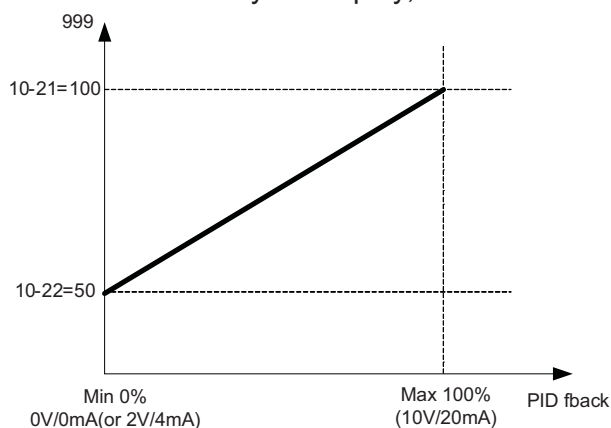

11 Performance control functions

11- 00 Prevention of Reverse operation

Range	【0】 :Reverse command is enabled 【1】 :Reverse command is disabled
--------------	---

➤ 11-00=1, the reverse command is **disabled**.

11- 01 Carrier Frequency

Range	【1~16】 KHz
--------------	-------------------

11- 02 Carrier mode selection

Range	【0】 :Carrier mode0 3-phase PW M modulation 【1】 :Carrier mode1 2-phase PW M modulation 【2】 :Carrier mode2 2-phase randomized PW M modulation
--------------	---

- Mode 0: 3-phase PWM Modulation Three Output transistors on at the same time (Full Duty).
- Mode 1: 2-phase PWM Modulation Two output transistors on at the same time (2/3 Duty).
- Mode 2: Random PWM Modulation This modulation method will use 3-phase PWM and 2-phase PWM modulation in a random mode.

Modes	Name	IGBT Duty	Heat Losses	Torque Performance	Waveform Distortion	Motor Noise
0	3-Phase PWM	100%	High	High	Low	Low
1	2-Phase PWM	66.6%	Low	Low	High	High
2	Random PWM	Between mode0 & mode1	Mid	Mid	Mid	Mid

11- 03 Carrier Frequency auto reduction by temperature raise

Range	【0】 :disable 【1】 :Enable
--------------	---

- When inverter (heatsink) temperature rises above 80°C the Carrier Frequency is reduced .
- When the temperature falls below less than 70°C, C arrier Frequency is reset to default. Temperature can be displayed by setting parameter 12-00=04000.

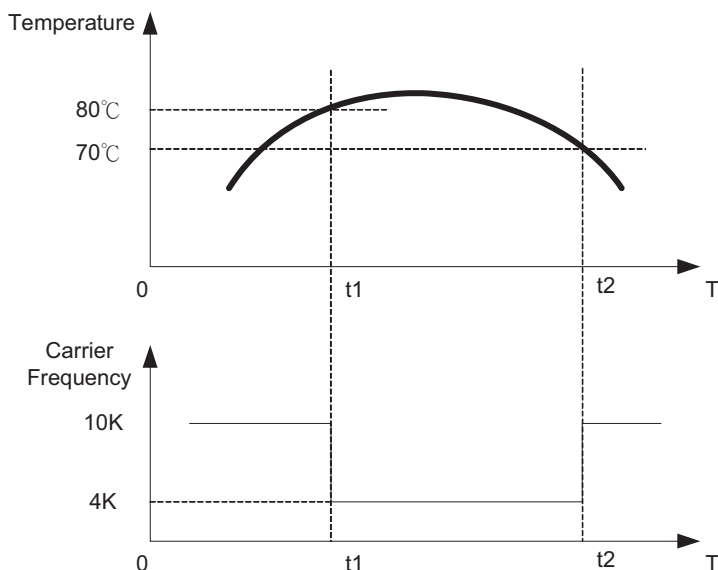

11-04	S-Curve Acc 1
11-05	S-Curve Acc 2
11-06	S-Curve Dec 3
11-07	S-Curve Dec 4
Range	【0.0 ~ 4.0】 s

- Use S Curve parameters where a smooth acceleration or deceleration action is required, this will prevent possible damage to driven machines by sudden acceleration/deceleration.

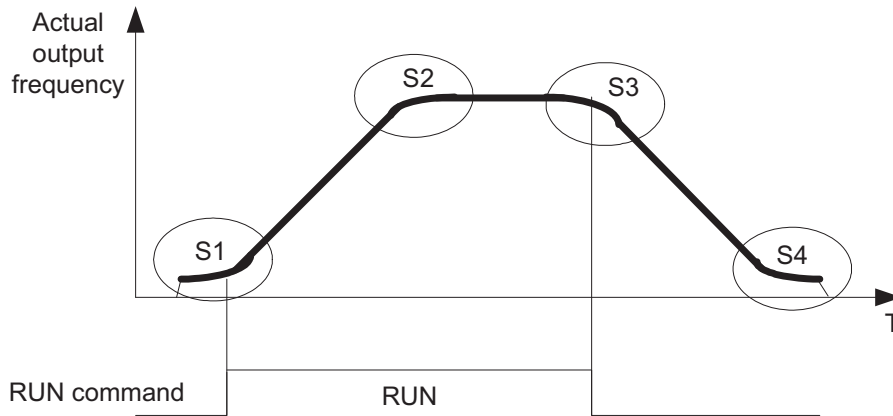

Note:

- Regardless of the stall prevention period, actual acceleration and deceleration time = preset acceleration / deceleration time + S curve time.
- Please set the required individual S curve times in the parameters (11-04~11-07).
- When S curve time (11-04~11-07) is set as 0, the S curve function is disabled.
- The calculation of S curve time is based on the Maximum output frequency of motor (01-02), Please refer to the parameters (00-14/00-15/00-16/00-17).
-

11-08	Skip frequency 1
11-09	Skip frequency 2
11-10	Skip frequency 3
Range	【0.00 ~ 650.00】 Hz
11-11	Skip frequency range. (\pm frequency band)
Range	【0.00 ~ 30.00】 Hz

Skip frequency parameters can be used to avoid mechanical resonance in certain applications.
Example: 11-08=10.00(Hz); 11-09=20.00(Hz); 11-10=30.00(Hz); 11-11=2.00(Hz).

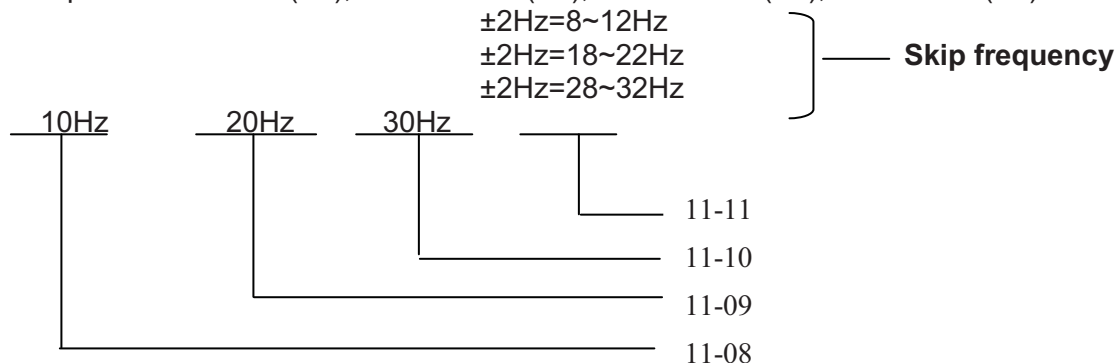

12- 05	Input and output terminal status display
Range	Read only(Panel read only)

- When any of S1 ~ S5 is turned on, corresponding segments on the digital display digits will be on.
- When relay output RY1 is on, the corresponding digit will be on as shown below.

Example 1: The following figure shows 12 - 05 display status, when S1, S3, S5 Inputs are ON and S2, S4 and RY1 are OFF.

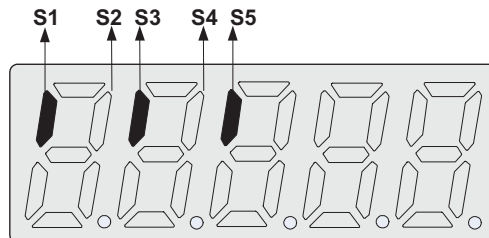

Example 2: The following figure shows 12 - 05 display status when S2, S3, S4 inputs are ON and S1, S5 are OFF but RY1 is ON.

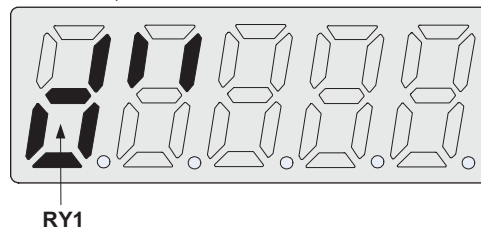

13 Inspection & Maintenance functions

13- 00	Drive Horsepower Code
Range	----

Inverter Model:	13- 00 Display
VE1 02 A240	2P2
VE1 04 A240	2P5
VE1 07 A240	201
VE1 15 A240	202
VE1 22 A240	203

13- 01	Software Version
Range	----

13- 02	Fault Log Display (Latest 3 faults)
Range	----

- Last three faults are stored in a stack and whenever there is a new fault the previous faults are pushed down the stack. So the fault stored in 2.xxx will be transferred to 3.xxx, and the one in 1.xxx to 2.xxx. The recent fault will be stored in the empty register 1.xxx.
- Use Up ▲ and Down ▼ keys to scroll between the fault registers.
- Pressing reset key when parameter 13-02 is displayed then all three fault registers will be cleared and the display for each register will change to 1. ---, 2. ---, 3. ---.
- E.g. fault log content is '1.OC-C'; this indicates the latest fault is OC-C, etc.

13- 03	Accumulated Inverter Operation Time 1
Range	【0~23】 Hours
13- 04	Accumulated Inverter Operation Time 2
Range	【0~65535】 Days
13- 05	Accumulated Inverter Operation Time Mode
Range	【0】 :Power on time 【1】 :Operation time

- When the operation time recorded in accumulator 1(Parameter 13-03) reaches 24 hours
- The recorded value in accumulator 2 parameter 13-04 changes to 1 day and the value in accumulator 1 is reset to 0000.

13- 06	Parameter lock
Range	【0】 :Enable all Functions 【1】 : Preset speeds 05- 01~05- 08 cannot be changed 【2】 :All Functions cannot be changed Except for preset speeds set in 05- 01~05- 08 【3】 :Disable All Function Except 13-06

- When the 13-07=00000 (not set a password), you can adjust the parameters 05-01~05-08 from 13-06.

13- 07	Parameter Lock Key Code
Range	【00000~65535】

- When a parameter lock key number is entered in parameter 13-07. For any parameter modification the key number has to be entered.
See following Parameter lock key setting example:-
- Setting Parameter lock key number example:-

Step1:

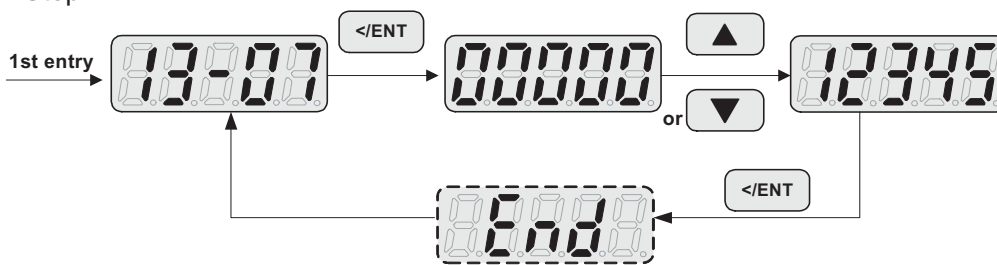

Step2

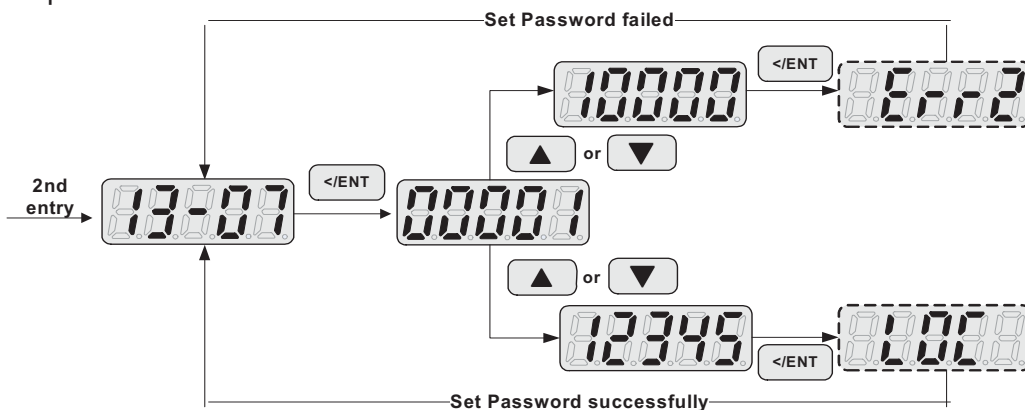

Key code (password) unlock

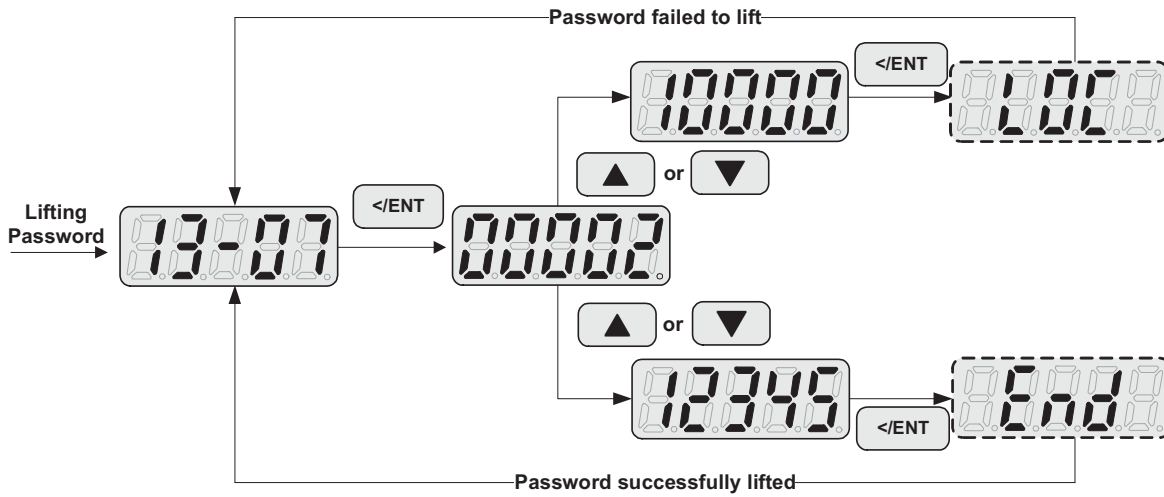

13-08	Reset Drive to Factory Settings
Range	【1150】 :Reset to the 50Hz factory setting 【1160】 :Reset to the 60Hz factory setting

- When a Parameter lock key number has been entered in parameter 13 – 07. This key number must be entered first before parameter 13-08 can be used.

Chapter 5 Troubleshooting and maintenance

5.1 Error display and corrective action

5.1.1 Manual Reset and Auto-Reset

Faults which can not be recovered manually			
Display	content	Cause	Corrective action
-oV-	Voltage too high when stopped	Detection circuit malfunction	Consult with the supplier
-oU-			
-LV-	Voltage too low when stopped	1. Power voltage too low 2. Pre-charge resistor or fuse burnt out. 3. Detection circuit malfunction	1. Check if the power voltage is correct 2. Failed resistor or fuse 3. Consult with the supplier
-LU-			
-oH-	The inverter is overheated when stopped	1. Detection circuit malfunction 2. Ambient temperature too high or bad ventilation	Improve the ventilation conditions, if no result then replace the inverter
-oH-			
CtEr	Current Sensor detection error	Current sensor error or circuit malfunction	Consult with the supplier
[CtEr]			
EPr	EEPROM problem	Faulty EEPROM	Consult with the supplier
[EPr]			
Cot	Communication error	Communications disruption	Check the wiring
[Cot]			
Faults which can be recovered manually and automatically			
Display	content	Cause	Corrective action
oC-A	Over-current at acceleration	1. Acceleration time too short 2. The capacity of the motor exceeds the capacity of the inverter 3. Short circuit between the motor coil and the case 4. Short circuit between motor wiring and ground 5. IGBT module damaged	1. Set a longer acceleration time 2. Replace inverter with one that has the same rating as that of the motor 3. Check the motor 4. Check the wiring 5. Consult with the supplier
o[C-A]			
oC-C	Over-current at fixed speed	1. Transient load change 2. Transient power change	1. Increase the capacity of the inverter 2. Install inductor on the power supply input side
o[C-C]			
oC-d	Over-current at deceleration	The preset deceleration time is too short.	Set a longer deceleration time
o[C-d]			
oC-S	Over current at start	1. Short circuit between the motor coil and the case 2. Short circuit between motor coil and ground 3. IGBT module damaged	1. Inspect the motor 2. Inspect the wiring 3. Consult with the supplier
o[C-S]			

oV-C	Excessive Voltage during operation/ deceleration	1.Deceleration time setting too short or excessive load inertia 2.Power voltage varies widely (fluctuates)	1.Set a longer deceleration time 2. Consider use of a reactor at the power input side
ou-C			
PF	Input phase Loss	Abnormal fluctuations in the main circuit voltage	1.Check the main circuit power supply wiring. 2.Check the power supply voltage
PF			
Faults which can be recovered manually but not automatically			
Display	content	Cause	Corrective action
oC	Over-current during stop	Detection circuit malfunction	Consult with the supplier
oL			
oL1	Motor overload	loading too large	Consider increasing the Motor capacity
oL1			
oL2	Inverter overload	Excessive Load	Consider increasing the inverter capacity
oL2			
LV-C	Voltage too low during operation	1.Power voltage too low 2.Power voltage varies widely (fluctuates)	1.Improve power quality 2.Consider adding a reactor at the power input side
LU-C			

5.1.2 Keypad Operation Error Instruction

Display	content	Cause	Corrective action
LoC	1.Parameter already locked 2.Motor direction locked 3.Parameter password (13-07) enabled	1.Modify frequency parameter while 13-06>0. 2.Reverse direction when 11-00=1。 3.Parameter (13-07) enabled, set the correct password will show LOC.	1.Adjust 13-06 2.Adjust 11-00
LoC			
Err1	Keypad operation error	1.Press ▲ or ▼ while 00-05/00-06>0 or running at preset speed. 2.Attempt to modify the Parameter.Can not be modified during operation (refer to the parameter list)	1.The ▲ or ▼ is available for modifying the parameter only when 00-05/00-06=0 2.Modify the parameter in STOP mode.
Err1			
Err2	Parameter setting error	1.00-13 is within the range of (11-08 ±11-11) or (11-09 ±11-11) or (11-10 ±11-11) 2.00-12 ≤ 00-13	1.Modify 11-08~11-10 or 11-11 Set 00-12>00-13
Err2			
Err5	Modification of parameter is not	1.Control command sent during communication.	1.Issue enable command before communication

Err5	available in communication	2.Modify the function 09-02~09-05 during communication	2.Set parameters 09-02~09-05 function before Communication
Err6	Communication failed	1.Wiring error 2.Communication parameter setting error. 3.Incorrect communication protocol	1.Check hardware and wiring 2.Check Functions(09-00~09-05).
Err7			
Err7	Parameter conflict	1.Modify the function 13-00/13-08. 2.Voltage and current detection circuit is abnormal.	If reset is not possible, please consult with the supplier.
Err7			

5.1.3 Special conditions

Display	Fault	Description
StP0 StP0	Zero speed at stop	Occurs when preset frequency <0.1Hz
StP1 StP1		
StP1 StP1	Fail to start directly On power up.	1. If the inverter is set for external terminal control mode (00-02/00-03=1) and direct start is disabled (07-04=1) 2. The inverter cannot be started and will flash STP1. 3. The run input is active at power-up, refer to descriptions of (07-04).
StP2 StP2		
StP2 StP2	Keypad Stop Operated when inverter in external Control mode.	1. If the Stop key is pressed while the inverter is set to external control mode (00-02/00-03=1) then 'STP2' flashes after stop. 2. Release and re-activate the run contact to restart the inverter.
E.S. E.S.		
E.S. E.S.	External Rapid stop	When external rapid stop input is activated the inverter will decelerate to stop and the display will flash with E.S. message.
b.b. b.b.		
b.b. b.b.	External base block	When external base block input is activated the inverter stops immediately and then the display will flash with b.b. message.
PdEr PdEr		
PdEr PdEr	PID feedback loss	PID feedback loss is detected.

5.2 General troubleshooting

Status	Checking point	Remedy
Motor runs in wrong direction	Is the wiring for the output terminals correct?	Wiring must match U, V, and W terminals of the motor.
	Is the wiring for forward and reverse signals correct?	Check for correct wiring.
The motor speed can not be regulated.	Is the wiring for the analog frequency inputs correct?	Check for correct wiring.
	Is the setting of operation mode correct?	Check the Run mode set in parameters 00-02/00-03.
	Is the load too excessive?	Reduce the load.
Motor running speed too high or too low	Check the motor specifications (poles, voltage...) correct?	Confirm the motor specifications.
	Is the gear ratio correct?	Confirm the gear ratio.
	Is the setting of the highest output frequency correct?	Confirm the highest output frequency
Motor speed varies unusually	Is the load too excessive?	Reduce the load.
	Does the load vary excessively?	1. Minimize the variation of the load. 2. Consider increasing the capacities of the inverter and the motor.
	Is the input power unstable or is there a phase loss ?	Consider adding an AC reactor at the power input side if using single-phase power. 2. Check wiring if using three-phase power
Motor does not run	Is the power connected to the correct terminals? is the charging indicator lit ?	1 Is the power applied? 2. Turn the power OFF and then ON again. 3. Make sure the power voltage is correct. 4. Make sure screws are secured firmly.
	Is there voltage across the output terminals T1, T2, and T3?	Turn the power OFF and then ON again.
	Is overload causing the motor to stall?	Reduce the load so the motor will run.
	Are there any abnormalities in the inverter?	See error descriptions to check wiring and correct if necessary.
	Is there a forward or reverse run command?	
	Has the analog frequency signal been input?	1. Is analog frequency input signal wiring correct? 2. Is voltage of frequency input correct?
	Is the operation mode setting correct?	Operate through the digital keypad

5.3 Troubleshooting of the Inverter

For trouble shooting of this inverter refer to section 5.1

5.4 Routine and periodic inspection

To ensure stable and safe operations, check and maintain the inverter at regular intervals.

Use the checklist below to carry out inspection.

Disconnect power after approximately 5 minutes to make sure no voltage is present on the output terminals before any inspection or maintenance.

Items	Details	Checking period		Methods	Criteria	Remedies
		Daily	1Year			
Environment & Ground connection						
Ambient conditions at the installation	Confirm the temperature and humidity at the machine	◎		Measure with thermometer and hygrometer	Temperature: -10 ~40°C (14~120°F) Humidity: Below 95%RH	Improve the ambient or relocate the drive to a better area.
Installation Grounding	Is the grounding resistance correct?		◎	Measure the resistance with a multi-tester	200Vclass: below 100Ω	Improve the grounding if needed.
Terminals & Wiring						
Connection terminals	Any loose parts or terminals?		◎	Visual check Check with a screwdriver	Correct installation requirement	Secure terminals and remove rust
	Any damage to the base ?		◎			
	Any corroded Terminals?		◎			
Wiring	Any broken wires?		◎	Visual check	Correct wiring requirement	Rectify as necessary
	Any damage to the wire insulation?		◎			
voltage						
Input power voltage	Is the voltage of the main circuit correct?	◎		Measure the voltage with a multi-tester	Voltage must conform with the spec.	Improve input voltage if necessary.
Circuit boards and components						
Printed circuit board	Any contamination or damage to printed circuit board?		◎	Visual check	Correct component condition	Clean or replace the circuit board
Power component	Any dust or debris		◎			Measure with a multi-tester
		Check resistance between terminals		◎	Consult with the supplier	
Cooling System						
Cooling fan	Unusual vibration and noise?		◎	Visual and sound check	Correct cooling	Consult with the supplier
	Excessive dust or debris	◎		Visual check		Clean the fan

Heat sink	Excessive dust or debris	⊙				Clean up debris or dust
Ventilation Path	Is the ventilation path blocked?	⊙				Clear the path

5.5 Maintenance

To ensure long-term reliability, follow the instructions below to perform regular inspection. Turn the power off and wait for a minimum of 5 minutes before inspection to avoid potential shock hazard from the charge stored in high-capacity capacitors.

1. Maintenance Check List.

➤ Ensure that temperature and humidity around the inverters is as required in the instruction manual, installed away from any sources of heat and the correct ventilation is provided..
➤ For replacement of a failed or damaged inverter consult with the local supplier.
➤ Ensure that the installation area is free from dust and any other contamination.
➤ Check and ensure that the ground connections are secure and correct.
➤ Terminal screws must be tight, especially on the power input and output of the inverter.
➤ Do not perform any insulation test on the control circuit.

2. Insulation test Method . Single Phase

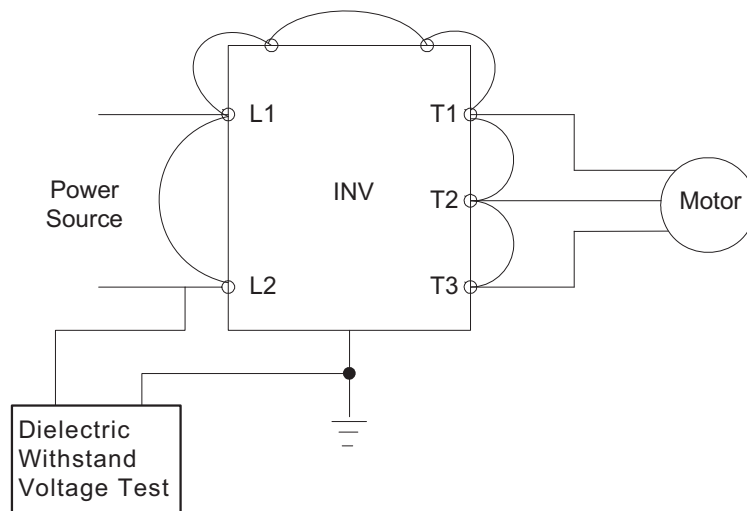

Chapter 6 Peripherals Components

6.1 Reactor Specifications

Model: VE1...A240	Specification	
	Current (A)	Inductance (mH)
02	3.0	7.0
04	5.2	4.2
07	9.4	2.1
15	19.0	1.1
22	25.0	0.71

6.2 Electromagnetic Contactor and No fuse circuit breaker

Model: VE1...A240	Molded-case circuit breaker	Magnetic contactor
02/04	TO-50E 15A	CN-11
07/15	TO-50E 20A	
22	TO-50E 30A	

6.3 Fuse Specification

Model: VE1...A240	HP	KW	Rating
02	0.25	0.2	10A , 300VAC
04	0.5	0.4	10A , 300VAC
07	1	0.75	20A , 300VAC
15	2	1.5	30A , 300VAC
22	3	2.2	30A , 300VAC

6.4 Fuse Specification(UL Model Recommended)

Model	Manufacture	Type	Rating
VE1 02 A240	Bussmann	10CT	10A, 690VAC
VE1 04 A240	Bussmann	10CT/16CT	10A/16A, 690VAC
VE1 07 A240	Bussmann	16CT/20CT	16A/20A, 690VAC
VE1 15 A240	Bussmann	30FE	30A, 690VAC
VE1 22 A240	Bussmann	50FE	50A, 690VAC

Appendix I – Parameters setting list

Customer					Inverter Model		
Using Site					Contact Phone		
Address							
Parameter Code	Setting Content	Parameter Code	Setting Content	Parameter Code	Setting Content	Parameter Code	Setting Content
00-00		03-04		05-17		07-01	
00-01		03-05		05-18		07-02	
00-02		03-06		05-19		07-03	
00-03		03-07		05-20		07-04	
00-04		03-08		05-21		07-05	
00-05		03-09		05-22		07-06	
00-06		03-10		05-23		07-07	
00-07		03-11		05-24		07-08	
00-08		03-12		05-25		08-00	
00-09		03-13		05-26		08-01	
00-10		03-14		05-27		08-02	
00-11		03-15		05-28		08-03	
00-12		03-16		05-29		08-04	
00-13		03-17		05-30		08-05	
00-14		03-18		05-31		08-06	
00-15		03-19		05-32		08-07	
00-16		04-00		06-00		08-08	
00-17		04-01		06-01		08-09	
00-18		04-02		06-02		09-00	
00-19		04-03		06-03		09-01	
00-20		04-04		06-04		09-02	
01-00		04-05		06-05		09-03	
01-01		04-06		06-06		09-04	
01-02		04-07		06-07		09-05	
01-03		04-08		06-16		09-06	
01-04		04-09		06-17		09-07	
01-05		04-10		06-18		09-08	
01-06		04-11		06-19		09-09	
01-07		04-12		06-20		10-00	
01-08		04-13		06-21		10-01	
01-09		04-14		06-22		10-02	
01-10		04-15		06-23		10-03	
01-11		05-00		06-32		10-04	
02-00		05-01		06-33		10-05	
02-01		05-02		06-34		10-06	
02-02		05-03		06-35		10-07	
02-03		05-04		06-36		10-08	
03-00		05-05		06-37		10-09	
03-01		05-06		06-38		10-10	
03-02		05-07		06-39		10-11	
03-03		05-08		07-00		10-12	

Parameter Code	Setting Content	Parameter Code	Setting Content	Parameter Code	Setting Content	Parameter Code	Setting Content
10-13		11-02		12-03			
10-14		11-03		12-04			
10-15		11-04		12-05			
10-16		11-05		13-00			
10-17		11-06		13-01			
10-18		11-07		13-02			
10-19		11-08		13-03			
10-20		11-09		13-04			
10-21		11-11		13-05			
10-22		12-00		13-06			
11-00		12-01		13-07			
11-01		12-02		13-08			