CONTENT

Chapter 1 General Introduction.....	3
1.1 Summary.....	3
1.2 Product List.....	3
1.3 Environmental Condition.....	3
1.4 specification.....	5
1.4.1 display specification.....	5
1.4.2 PLC specification.....	5
1.4.3 Appearance.....	7
1.4.4 Dimension.....	8
Chapter 2 PLC Introduction.....	8
2.1 Functions.....	8
2.1.1 CPU Status and LEDs.....	8
2.1.2 USB Programming port.....	9
2.1.3 Serial Communication Port.....	10
2.1.4 High Speed Counter and High Speed Pulse Output.....	10
2.1.5 Edge Interrupts.....	10
2.1.6 Data Retentive and Data Backup.....	10
2.1.7 Real-time Clock (RTC).....	11
2.1.8 Backup Battery.....	12
2.2 Wiring diagram.....	12
2.3 Dimension.....	14
2.4 Technical Specification.....	14
Chapter 3 Software Introduction.....	16
3.1 HMI programming.....	16
3.1.1 Create project.....	16
3.1.2 Edit configuration	19
3.1.3 download link for HMI manual.....	19

3.2 PLC.....	20
3.2.1 introduction.....	20
3.2.2 Install driver of USB programming port.....	20
3.2.3 High speed counter.....	32
3.2.3.1 Operation Modes and Inputs of the High-speed Counters.....	33
3.2.3.2 Control Byte and Status Byte.....	34
3.2.3.3 Preset value (PV value) setting.....	36
3.2.3.4 “CV=PV” Event No.....	38
3.2.3.5 How to use high speed counter.....	39
3.2.4 How to use high speed pulse output.....	40
3.2.4.1 High speed pulse output instruction.....	41
3.2.4.2 How to use PLS instruction.....	41
3.2.4.2.1 High-speed Pulse Output Function of HMI-PLC.....	42
3.2.4.2.2 PTO/PWM Register.....	44
3.2.4.2.3 PTO Operations.....	46
3.2.4.2.4 PWM Operations.....	48
3.2.5 How to Use Position Control Instructions.....	49
3.2.5.1 How to Modify the Current Value of Position Control Instructions.....	49
3.2.5.2 Can it change maximum output frequency when position control instruction is executing?.....	52
3.3 The use of analog quantities.....	52
3.3.1 Wiring diagram.....	52
3.3.2 Measurement Ranges and The measured value Representation.....	52
3.3.3 Configuration in software.....	54

Chapter 1 General Introduction

1.1 Summary

Kinco MK series combines the superior technology of Kinco HMI and PLC and the Internet of Things (M-IoT). It is an economical all-in-one machine product that supports the Internet of Things functions launched by Kinco Company.

The Kinco MK series all-in-one HMI-PLC retains the high cost performance of the Kinco HP series of all-in-one machines, but adopts a high-performance CPU and the new DTools software technology platform for programming the HMI, so as to support more rich picture components and functions of the new software. In addition, combined with the Kinco M-IoT technology platform it provides remote download, pass through PLC communication over the network, VNC remote monitoring, equipment management and other advanced remote operation and maintenance functions. This will provide more value for our users.

1.2 Product List

Item	Type	Specification
MK070	MK070E-33DT	DC24V, DI 16*DC24V, DO 14*DC24V, 2*AI, 1*AO, USB2.0 Programming port (PLC&HMI sharing same programming port). PLC Part share 2*RS485 COM port, Supports up to 8 KS series expansion modules. HMI part provides Ethernet interface, supports access to external network or other Ethernet devices.

1.3 Environmental Condition

Kinco MK series accords with GB/T 15969.3-2007 (idt IEC61131-2: 2007) standard and test specifications.

The following table lists the conditions and requirements for MK series to work properly. It is the user's responsibility to ensure that the service conditions are not exceeded.

Transport and storage		
Ambient conditions	temperature	-10°C ~ +60°C
	relative humidity	10%~95%, no condensation
	Altitude	Up to 3000 m
Mechanical conditions	Free falls	within manufacturer's original packaging, 5 falls from 1m of height.
Normal Operation		
Ambient conditions	air temperature	Open equipment : -10 --- +55°C; Enclosed equipment: 0~50°C
	relative humidity	10%~95%, no condensation
	Altitude	Up to 2000 m
	Pollution degree	for use in pollution degree 2.
Mechanical conditions	Sinusoidal vibrations	5<f<8.4Hz, Occasional: 3.5mm amplitude; Continuous: 1.75mm amplitude. 8.4<f<150, Occasional: 1.0g acceleration; Continuous: 0.5g acceleration.
	Shock	occasional excursions to 15g, 11 ms, half-sine, in each of 3 mutually perpendicular axes.
Electromagnetic compatibility (EMC)	Electrostatic discharge	±4kV Contact, ±8kV Air. Performance criteria B.
	High energy surge	a.c. main power: 2KV CM, 1KV DM; d.c. main power: 0.5KV CM, 0.5KV DM; I/Os and Communication port: 1KVCM. Performance criteria B.
	Fast transient bursts	main power: 2KV, 5KHz. I/Os and Communication port: 1KV, 5KHz. Performance criteria B.
	Voltage drops and interruptions	a.c. supply: at 50Hz, 0% voltage for 1 period; 40% voltage for 10 periods; 75% voltage for 20 periods. Performance criteria A.
Ingress Protection Rating		IP65

1.4 specification

1.4.1 display specification

Type	MK070E-33DT
LCD size	7" TFT
Resolution	800*480
Color	256K colors
Brightness	250cd/m ²
Back light	LED
Touch panel	4 lines, resistor web (4H)
Life	50000 hours
Processor	700MHz RISC
Ethernet	10M/100M self-adaption
Memory	128MB Flash + 64MB DDR2 RAM
Recipe memory	256KB+RTC
Expansion memory	1 USB Host
Programming download	1*USB Slave/Ethernet/USB Flash disk
Printer port	USB
Software	DTools programming + EdgeAccess for remote services + Kinco Miot for IoT function

1.4.2 PLC specification

Parameters	MK070E-33DT
Power supply	
Rated voltage	DC24V
Voltage range	DC20.4V—28.8V
I/O communication	

Digital IO	DI 16*DC24V, DO 14*Transistor
Analog IO	AI2*IV, AO 1*IV (Supports voltage and current type)
Expansion	Up to 8 module;Support KS series expansion module
Programming port	USB2.0 Slave
Serial port	2*RS485, PORT1&PORT2, Baudrate up to 115.2kbps. Port 1:Support programing, Modbus RTU master and slave,Free protocol Port 2: Modbus RTU master and slave,Free protocol
High speed counter	4 Support single,double UP/DOWN,AB phase pulse input. 4 max 50KHz.
High speed output	4 Q0.0,Q0.1,Q0.4 max output 50 Khz (The load resistance must be less than 3K Ω at maximum frequency) Q0.5 max output 10Khz.
Interrupt	4 , I0.0-I0.3 can be on/off interrupt.
Memory area	
Programming	Max. 4K instruction
Users data	M area 1K bytes; V area 4K bytes
Data backup	E2PROM, 448 bytes
Retentive range	V area 2K bytes:VB0-VB1907 ; C area : C0-C63. 3 year at normal temperature
Others	
RTC	256 1ms time base: 4 10ms time base: 16 100ms time base: 236

Interrupt	2, 0.1ms time base.
Counter	256
RTC	Yes. The difference is less than 5min/month at 25°C.

1.4.3 Appearance

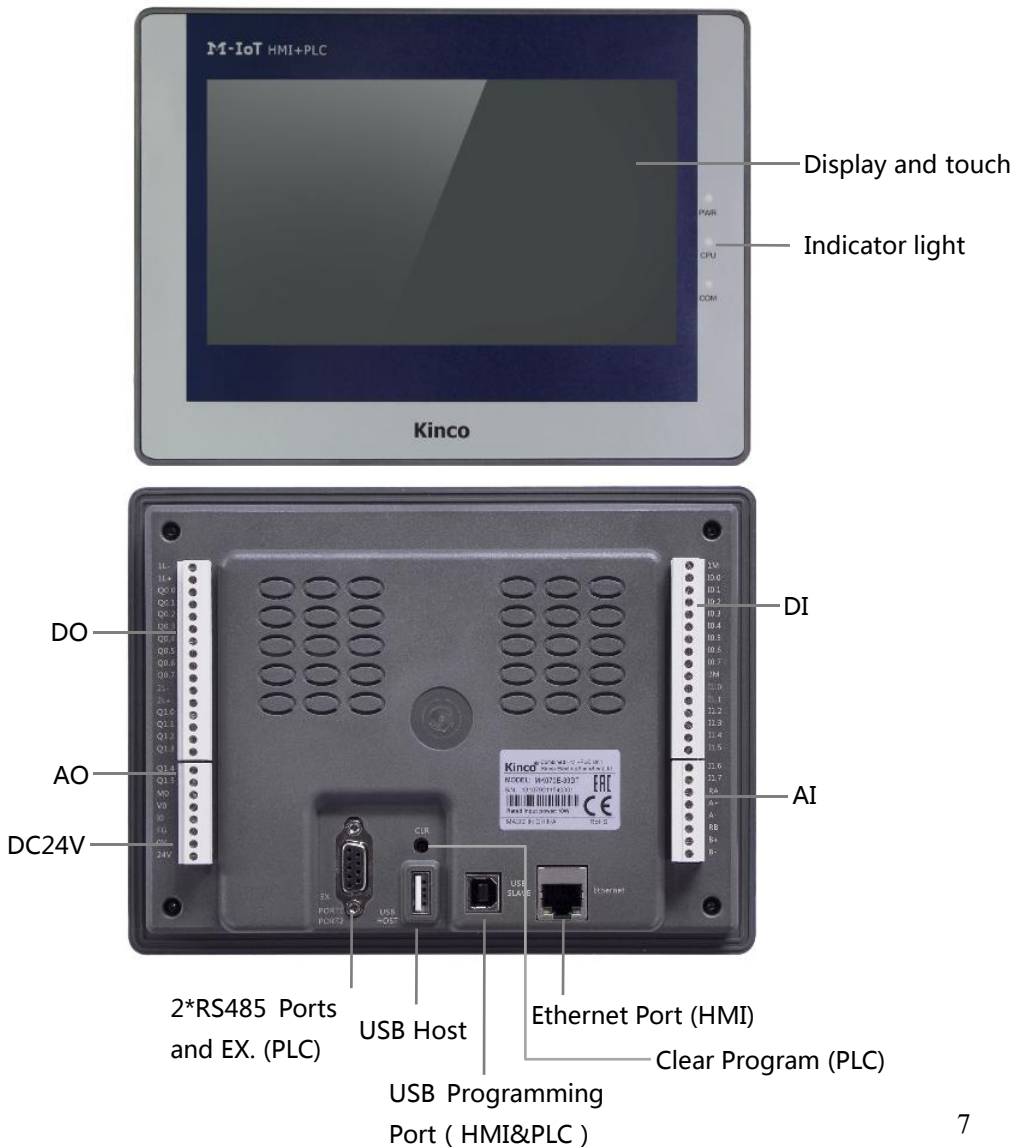

1.4.4 Dimension

	MK070E-33DT
Dimension	204*150*38.55mm
Cutout size	192*138mm

Chapter 2 PLC Introduction

2.1 Functions

2.1.1 CPU Status and LEDs

The CPU has two modes: STOP mode and RUN mode.

In RUN mode, the CPU executes the main scan cycle and all interrupt tasks. In STOP mode, the CPU only process communication requests which comes from KincoBuilder software and other Modbus RTU master device. At the same time, all output points are immediately output to the "stop output" value defined in **[Hardware Configuration]** of the user project.

➤ Change CPU status

HMI-PLC provides one way for manually changing the CPU status: Executing [RUN] or [STOP] in Kincobuilder.

Usually when the PLC is power on, default status of PLC is RUN status.

Below situation, the PLC status depend on Kincobuilder programming

- a— PLC RUN mistake (strong mistake) will stop the PLC
- b— The user use Kincobuilder [setup], PLC is RUN/STOP status
- c— Users use STOP instruction to stop PLC
- d— If downloading project failed, PLC will keep STOP status.

2.1.2 USB Programming port

HMI-PLC uses USB (USB2.0) port as programming port. This type of interface is consistent with most Kinco HMI products. Users can use cables with same connector port for PLC programming. The USB programming port of MK070E PLC and HMI are sharing one.



In PC, the programming port of HMI-PLC will be a virtual COM port, you must install the driver for it when using in PC first time. After finishing installing software Kincobuilder , there will be different drivers in the path “\Kincobulider V***\Drivers\” for different versions of Windows system. Right now it can only support Windows XP, Windows 7, Windows 8 and Windows 10. When connecting programming cable to HMI-PLC and PC first time, Windows system will detect new hardware and mention installing driver, users can install the driver according to the version of Windows.

When the first time using USB cable to download Program on MK series. The USB driver is needed installation. The installation step please refer to Kinco HPbuilder [Help]-[User Manual]--Chapter 2.10

2.1.3 Serial Communication Port

MK070E providing 2*RS485 COM, which is Port1 and Port2, the Baudrate up to 115.2Kbps. Port1 could use as programming port, as well as Modbus RTU Master/Slave protocol, and free communication. Port2 could use as Modbus RTU Master/Slave protocol, free communication.

And please refer to [2.2 Wiring diagram](#) to know about their pin assignment.

2.1.4 High Speed Counter and High Speed Pulse Output

MK070E provides 4 high speed counters (HSC0~HSC3). High speed counter supports a variety of modes, it can be single-phase, dual-phase (Up/Down), AB phase (1-fold and 4-fold frequency). The maximum counting frequency of the four pulse counters is 50KHz.

CPU	Single phase		AB phase	
	HSC0 and HSC1	HSC2 and HSC3	HSC0 and HSC1	HSC2 and HSC3
MK070E	50K	50K	50K	50K

MK070E also provides 4 high speed pulse outputs (Q0.0, Q0.1, Q0.4 and Q0.5) and all support PTO (pulse train) and PWM (pulse width modulation) output. The highest frequency of each series of CPU is as follows (The resistor of load should be less than 3K Ω).

CPU	Q0.0	Q0.1	Q0.4	Q0.5
MK070E	50K	50K	50K	10K

2.1.5 Edge Interrupts

I0.0-I0.3 in CPU support edge interrupt function, it can execute interrupt by rising edge and falling edge of input signal. By using this function, it can capture the rising edge and falling edge of input signal quickly. For some input signal whose pulse width is less than the CPU scan time, it can respond quickly.

2.1.6 Data Retentive and Data Backup

Data retentive means the data in RAM can retain after power failure. CPU provides a lithium

battery (Replaceable but un-rechargeable) for data retentive. When CPU loses power, the data in the RAM will be maintained by the lithium battery, and the retentive ranges will be left unchanged at next power on. Through [Hardware] configuration in KincoBuilder, user can select the type of data retentive (Such as V,C area) and the range. The life of battery is 5 years and the retaining duration is 3 years at normal temperature.

Data backup is that CPU provides an E²PROM to store data permanently. At power on, the CPU will restore the data from E²PROM into RAM to execute.

Note: Because E²PROM has a writing limit of 1 million times, users should avoid to write data into data backup area frequently.

There are 448 bytes in V area for data backup (VB3648--VB4095),the data in this area will save in E2PROM automatically.HMI-PLC sets VB3648--VB3902 as data backup by default,if user needs to use VB3903--VB4095 for data backup,it needs to configure in 【PLC hardware configuration】.The configuration interface is as following figure.



2.1.7 Real-time Clock (RTC)

The real-time clock built in the all CPU modules can provide real-time clock/calendar indication. Users need to use KincoBuilder 【PLC】 -> 【Time of Day Clock...】 to set the clock when using RTC first time. Then users can use real-time clock instructions (READ_RTC、SET_RTC、RTC_W、RTC_R) .

After CPU power off, the real-time clock can be maintained by lithium battery. The life of battery is 5 years and the retaining duration is 3 years at normal temperature.

The HMI real time (RTC) function can provide real-time time/calendar, user can change RTC from the system Setting , or through register LW10000 - LW10006 to modify time. MK070E RTC can be kept after power off. If precise time is required, user also can set HMI RTC synchronization with PLC CPU. Please refer to DTOOLS use manual chapter 2.7 RTC Set (2.7.3 System time and PLC Time synchronization)..

2.1.8 Backup Battery

HMI-PLC can use certain specification lithium battery as backup battery. When PLC is power-off, it will use the backup battery to maintain real-time clock and RAM. The MK070E backup battery also supplies power to the RTC of the HMI and PLC to maintain the clock.

The backup battery is removable, user can replace new battery by themselves when the battery is empty.



The lithium battery is CR2032(3V) with connector. As shown in figure, user can order the battery separately.

2.2 Wiring diagram

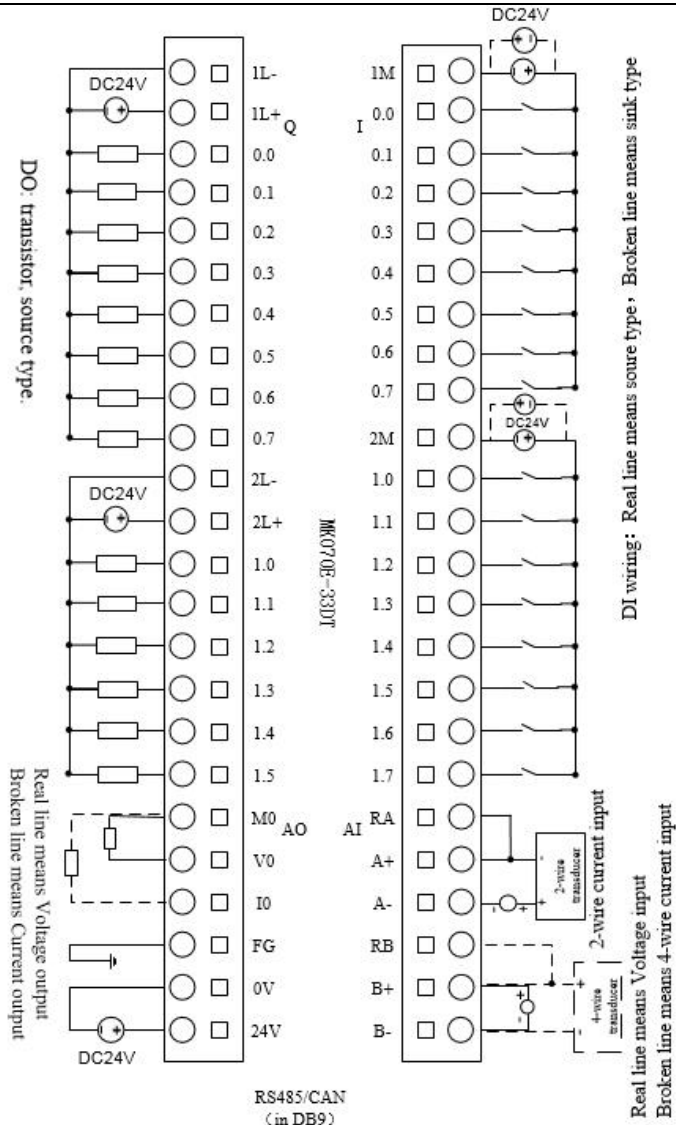

RS485/CAN
(in DB9)

	Function	Pin
Port1	A	6
	B	1
Port2	A	9
	B	4
CAN	CANH	7
	CANL	2
GND	GND	5

MK070E-33DT

2.3 Dimension

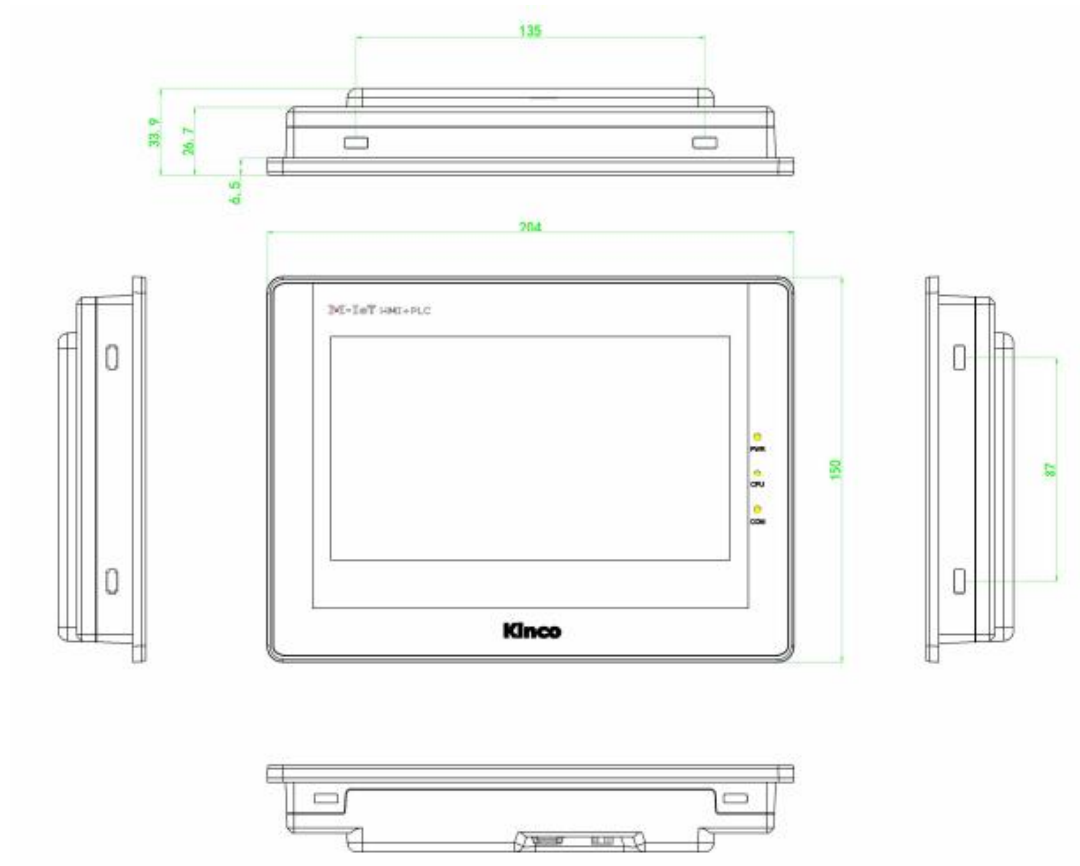

MK070E

2.4 Technical Specification

➤ DI Specifications

Input type	Source/Sink
Rated input voltage	DC 24V (Max. 30V)
Rated input current	3.5mA@24VDC
Max input voltage of logic 0	5V@0.7mA
Minimum input voltage of logic 1	Common channel: 11V@2.0mA

Input filter time delay · off-to-on · on-to-off	Common channel: 15 μ s; HSC channel: 10 μ s(50k) Common channel: 60 μ s; HSC channel: 6 μ s (50k)
Isolation between input and internal circuit · Mode · Voltage	Opt-electrical isolation 500VAC/1 min

➤ DO Specifications(Transistor type)

Output type	Source
Rated power supply voltage	DC24V, allowance range: DC20.4V—DC28.8V.(Same as power supply)
Output current per channel	Rated current:200mA @24VDC
Instant impulse current per channel	1A,less than 1s
Output leakage current	Max.0.5 μ A
Output impedance	Max. 0.2 Ω
Output delay · off-to-on · on-to-off	Common channel: 15 μ s; HSC channel: 10 μ s(50k) Common channel: 35 μ s; HSC channel: 6 μ s(50k)
Protection: ·Reverse polarity protection of power supply ·Inductive load protection ·Short-circuit protection ·Reverse polarity protection of output	No Yes Yes Yes, less than 10s.
Isolation between output and internal circuit · Mode · Voltage	Opto-electrical isolation 500VAC/1 min

➤ MK070E AI/AO Specification

Parameter	
AI	2
Rated Power supply	DC 24V, $\geq 100\text{mA}$
Signal	4-20mA、1-5V、0-20mA、0-10V
Resolution	12 bits
Accuracy	0.3% F.S.
Signal limitation	Current signal input could not over 24mA, Voltage signal input Could not over 12V
Speed (each channel)	15 times/sec
input resistance	Current mode: $\leq 250\ \Omega$ Voltage mode: $> 4\text{M}\ \Omega$
AO	1
Rated Power supply	DC 24V $\geq 100\text{mA}$
Signal	4-20mA、1-5V、0-20mA、0-10V
Resolution(including symbol bit)	12 bits
Accuracy	0.3% F.S.
Speed (each channel)	15 times /s
Output resistance	Current mode:Maximum 500 Ω Voltage mode :Minimum 10K Ω

Chapter 3 Software Introduction

3.1 HMI programming

HMI programming software: Kinco DTools. Download link for HMI software

<http://en.kinco.cn>

3.1.1 Create project

Process to create project based on Kinco DTools.

1, create project

Open Kinco DTools

1.1 create new project

(1) click menu **【File】** -- **【new】** to create project;

- (2) input project name;
- (3) Select path for saving project;
- (4) Click **【OK】**

1.2 choose device, connect and setup parameters

① choose device—choose communication

Drag “Serial port”in **【Graph element window】** -- **【Connector】** to construct window.



②Choose device—choose HMI type

Drag “MK070E”in **【Graph element window】** -- **【HMI】** to construct window.

System will show ”Display Mode”, we can choose “Horizontal” or “Vertical”

Click **【OK】**

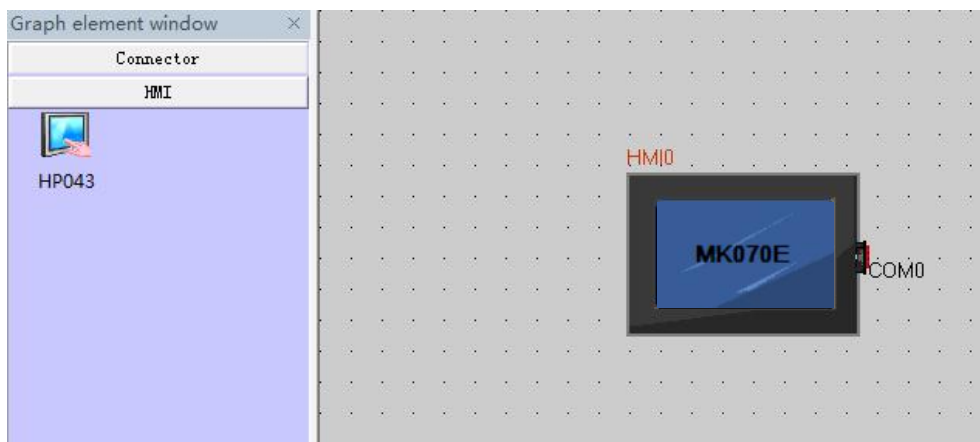

③choose device—choose PLC type (communication protocol)

Drag “Kinco PLC series” in **【Graph element window】** to construct window

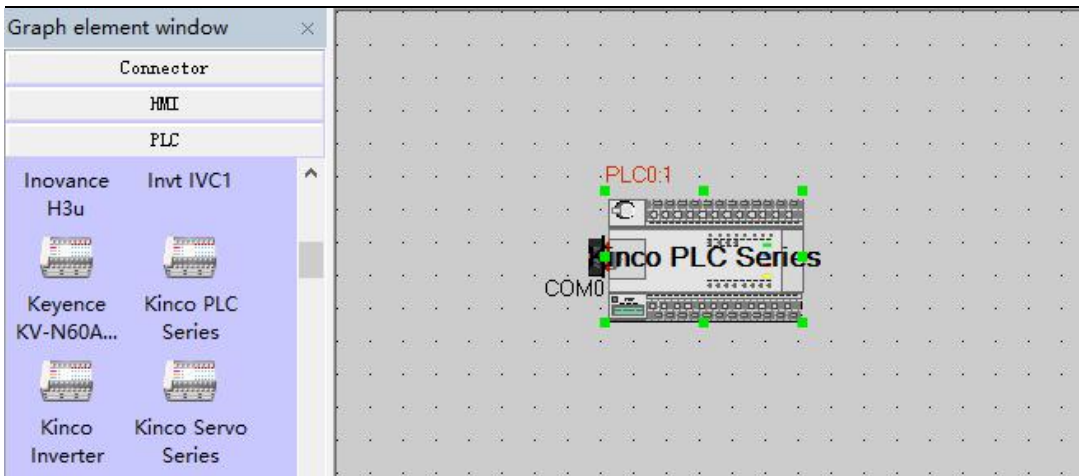

1.3 connect devices

Drag “COM” of HMI to close left side of connector, until connector and “COM” move together. Connect PLC and serial port with same way.

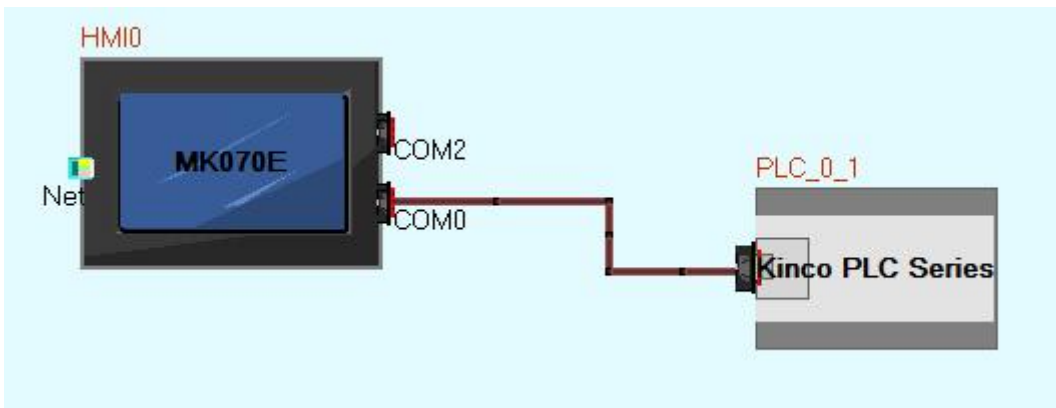

1.4 parameters setup-HMI

- (1) Double click HMI, it will appearance **【HMI Attribute】**
- (2) Find **【Task Bar】**
- (3) Cancel the “√” of “Display Task Bar”
- (4) Setup COM0 parameter at **【COM0 setting】** based on PLC real communication parameters. All others will be default

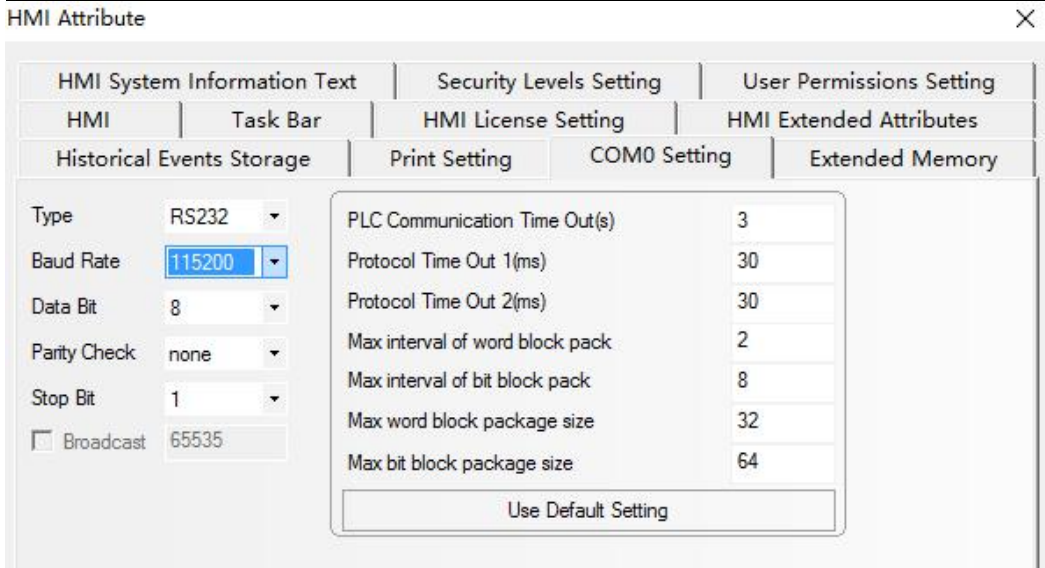

HMI COM0 setting



3.1.2 Edit configuration .

Reference Kinco DTools manual.

3.1.3 download link for HMI manual

https://en.kinco.cn/Download/D_enUserManual/HMI/Kinco%20DTools%20User%20Manual.pdf

3.2 PLC

3.2.1 introduction

Kinco MK series use Kincobuilder programming software and same instructions, same as HP series. And MK070E improve some functions, pls reference the manual.

Pls reference Kincobuilder software **【Help】** or download K5/K2 software for most functions.

https://en.kinco.cn/Download/D_enUserManual/PLC/Software%20manualfor%20K5_20190516.zip

3.2.2 Install driver of USB programming port

MK series provide USB programming port. This programming port will be used as virtual serial port in PC. Its driver files are located in \drivers in Kincobuilder installation folder. Right now it supports Windows XP、Windows 7、Windows 8 and Windows 10 systems, as shown in following figure:

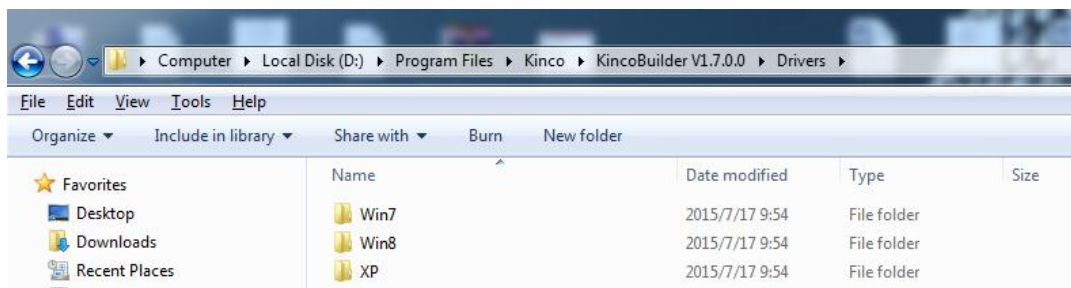

When connecting programming cable to MK series and PC first time, Windows system will detect new hardware and mention installing driver, users can install the driver according to the version of Windows.

➤ **Fail in installing driver in Windows 7?**

If it is simplified Win7 system, it will be lack of files mdmcpq.inf and usbser.sys, so it can not install the virtual serial port.

These two files are in the path ..\Win7\windows, users can copy these two files to following

path and install the driver again.

- Copy mdmcpq.inf to C:\WINDOWS\INF.
- Copy usbser.sys to C:\WINDOWS\SYSTEM32\DRIVERS\

➤ **How to install driver in Windows 8, Windows 10 ?**

- 1、 If you can use internet, Win8/Win10 will update driver automatically .

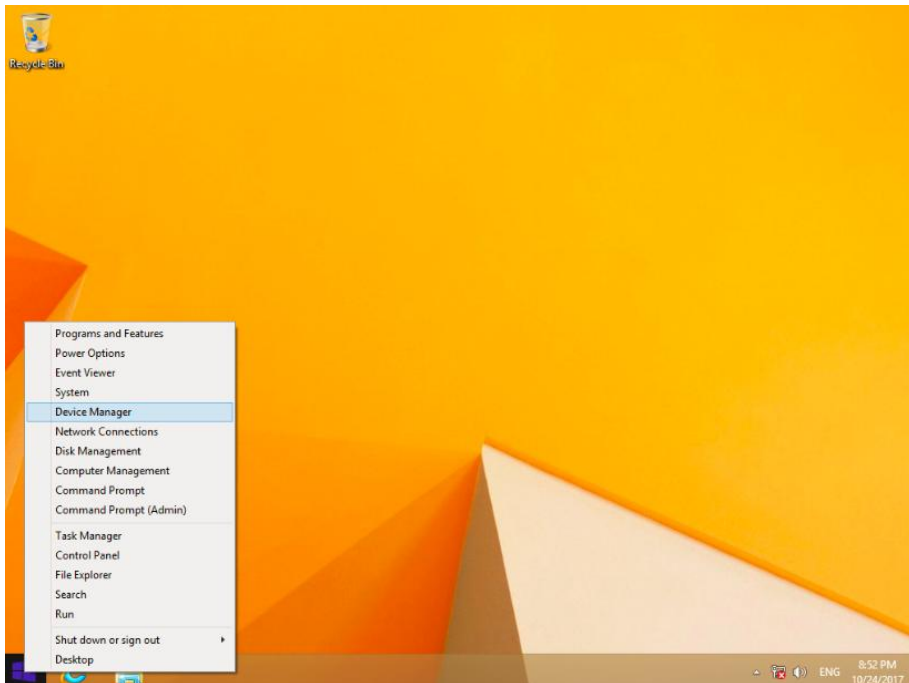

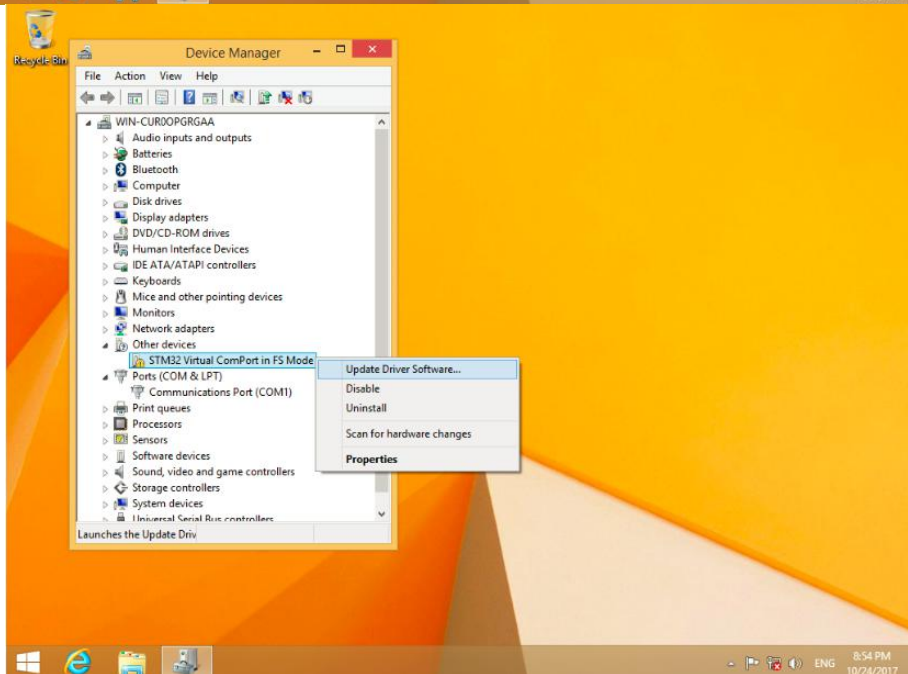
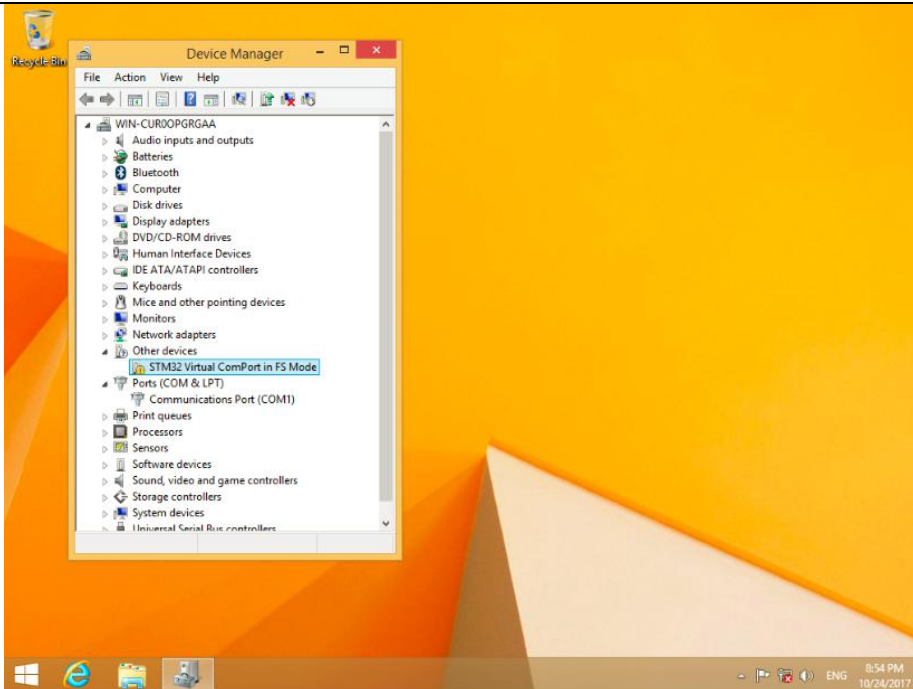

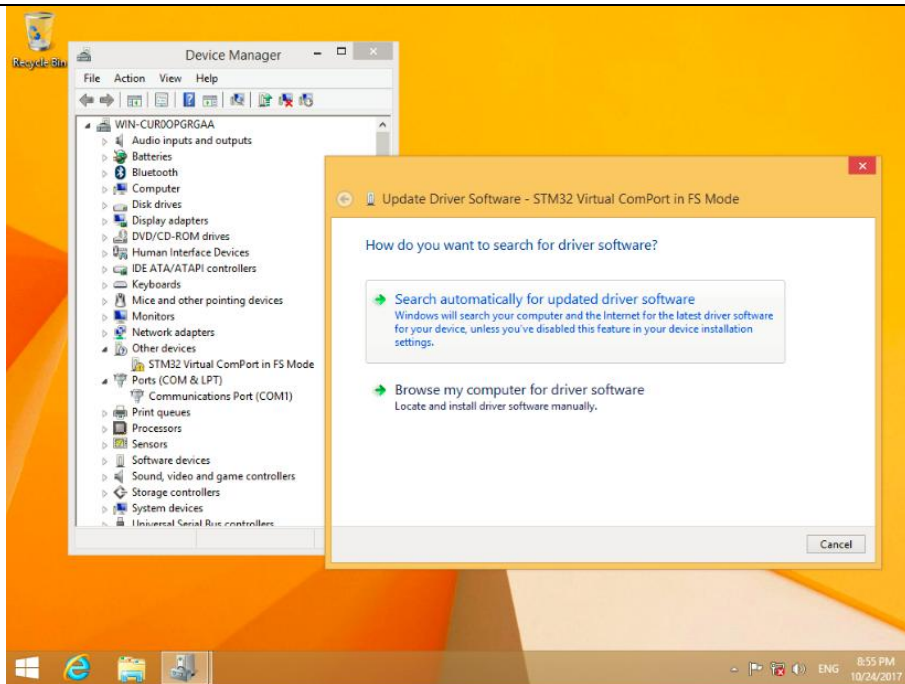

2、 If you have not internet, pls reference below information.

Below picture is advanced starting of Win8

Find advanced starting, then choose 7 to forbid driver signature.

(1) Install PLC drive according Window guidance.

Choose driver files in Win8.

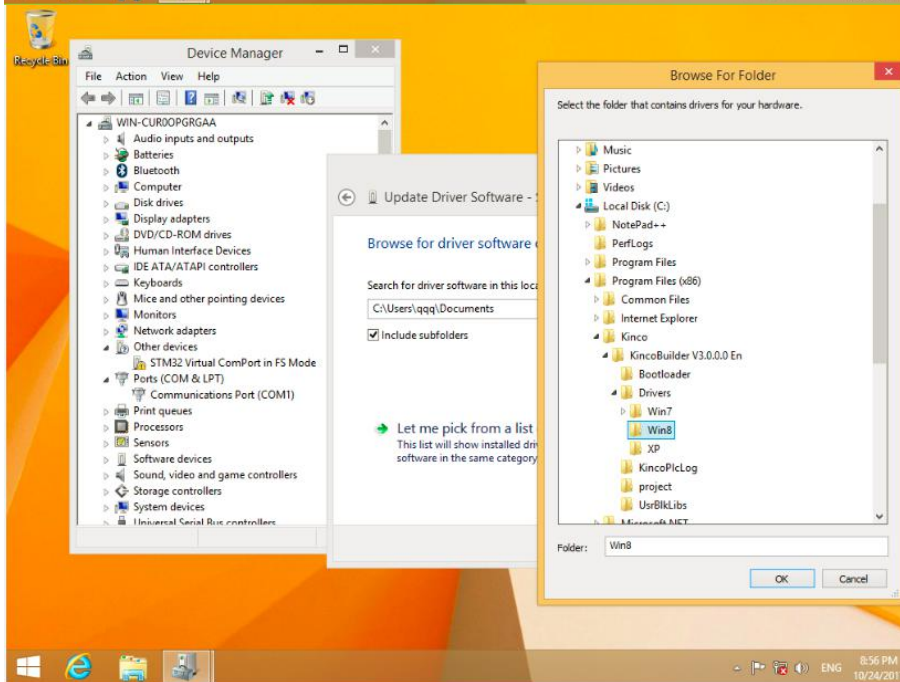
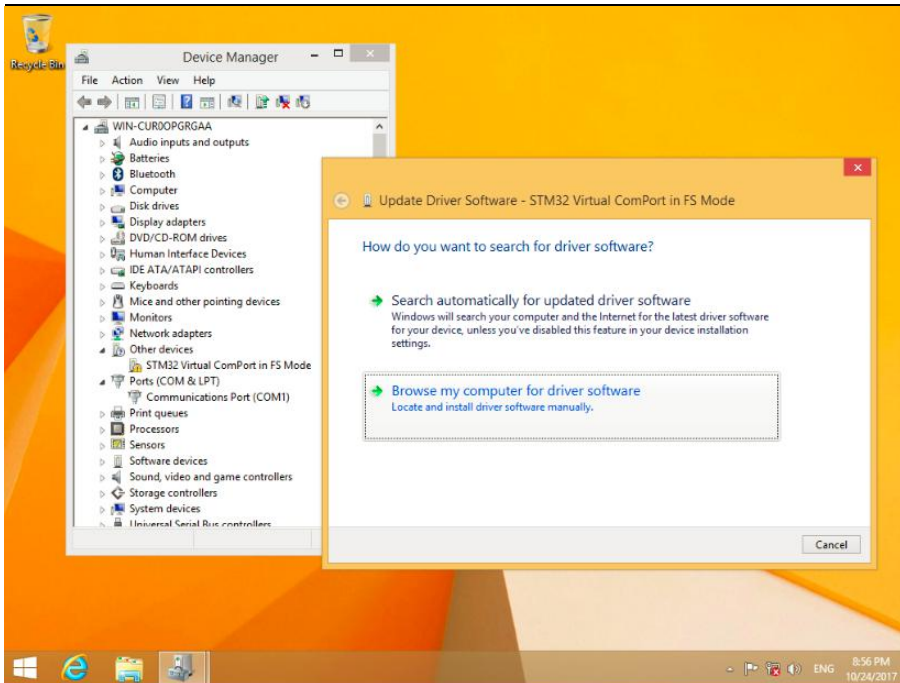

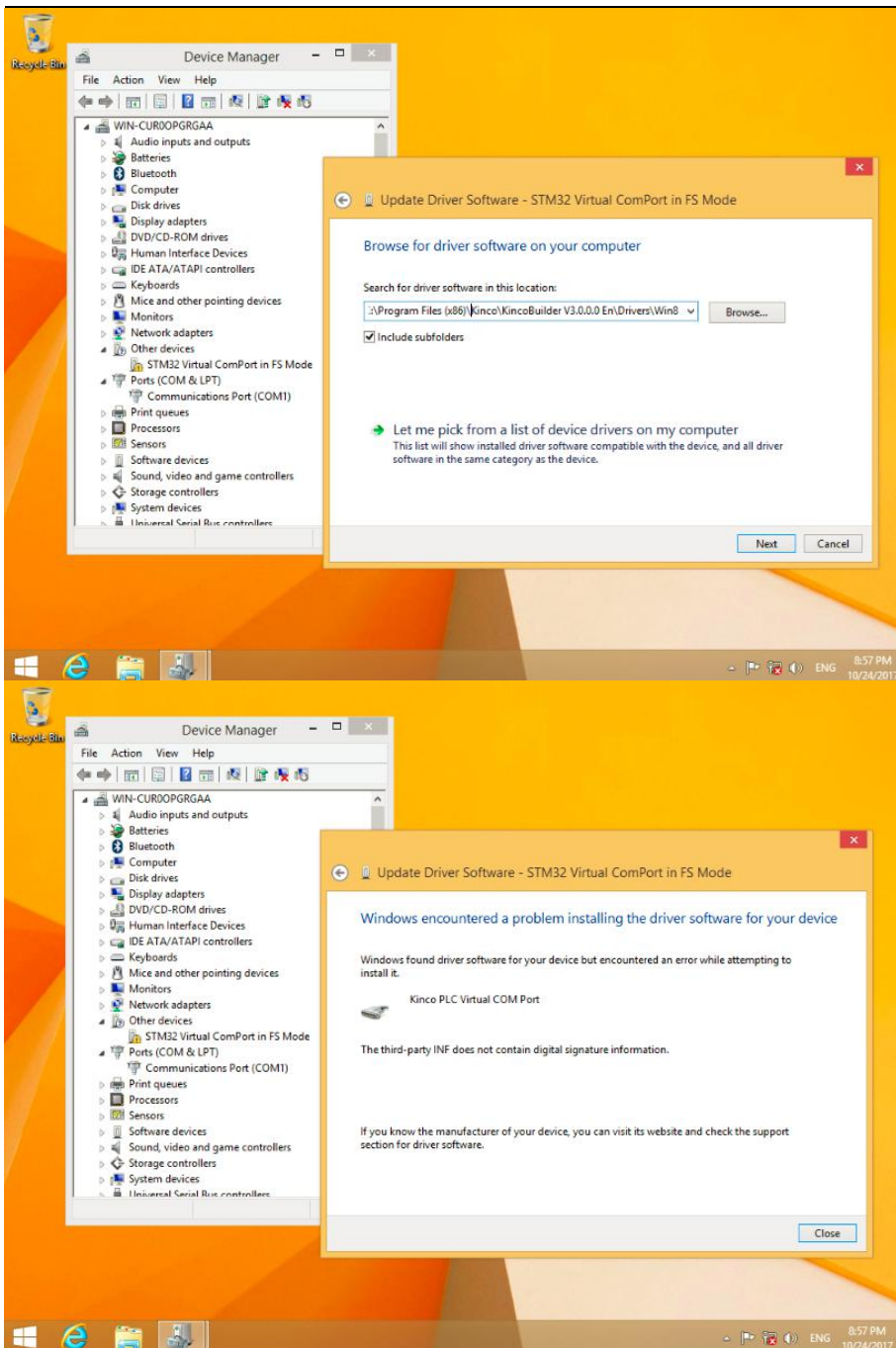

(2) It will show “settings” when mouse at the right side of Window, then click “settings”

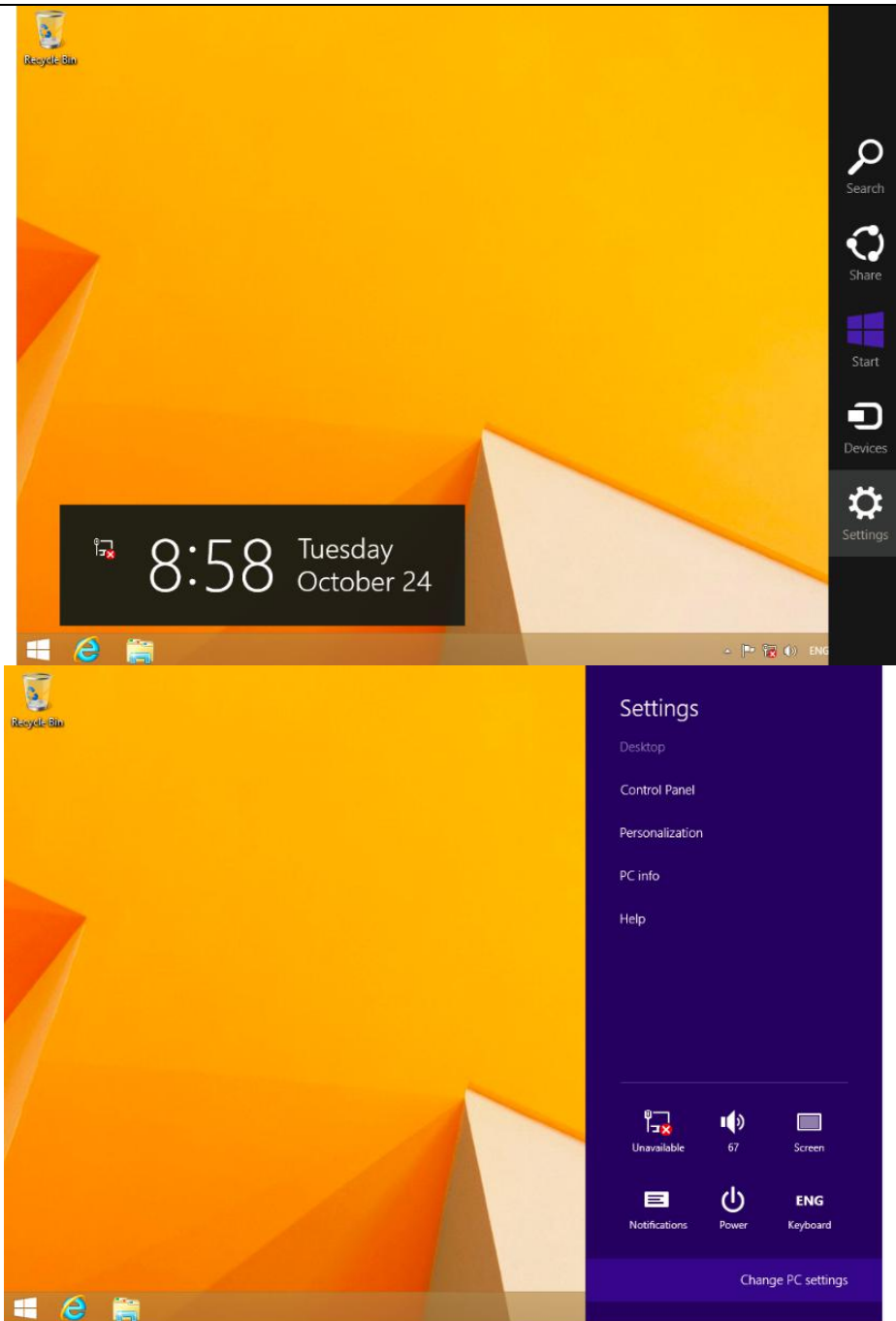

(3) Click “update and recovery” in the “PC settings”

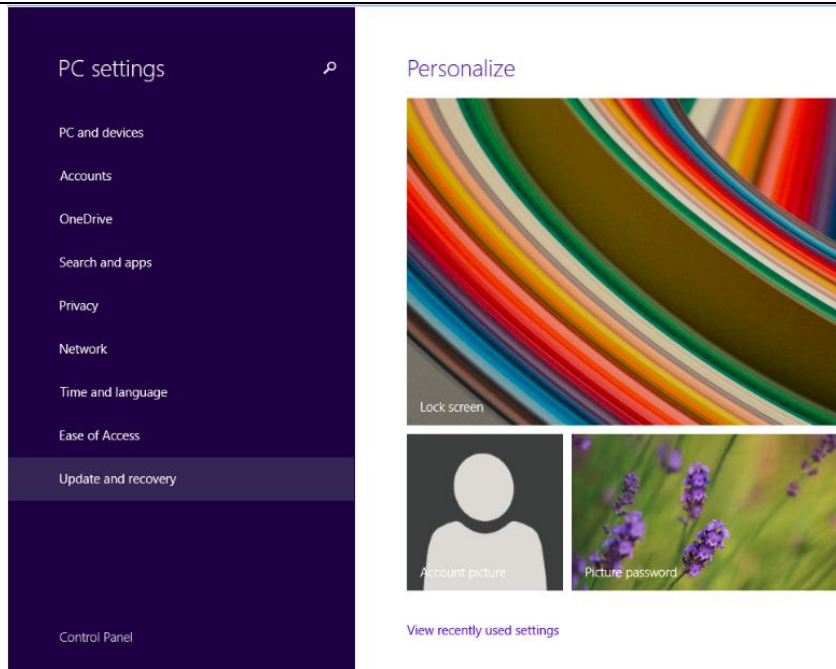

(4) Click “restart now” at advanced startup

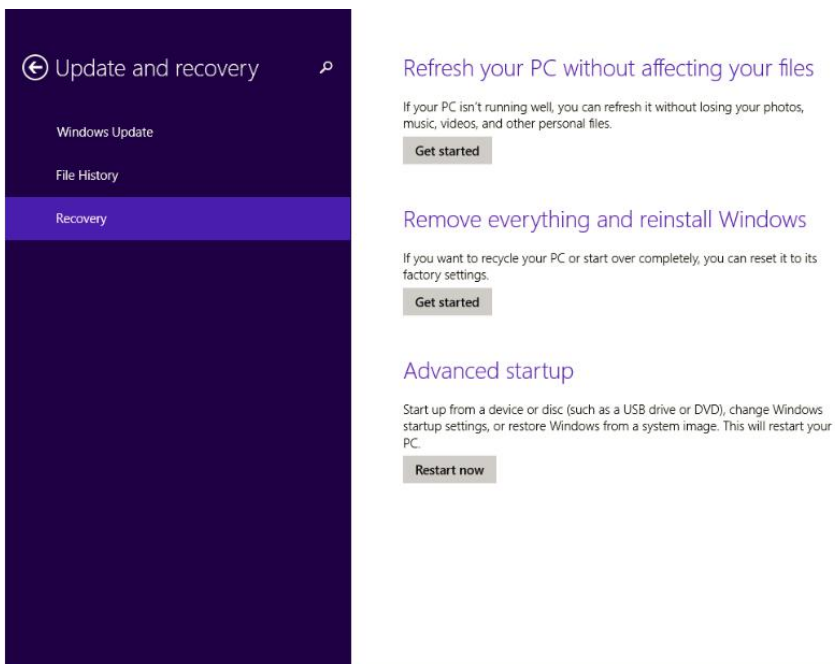

(5) Click advanced options

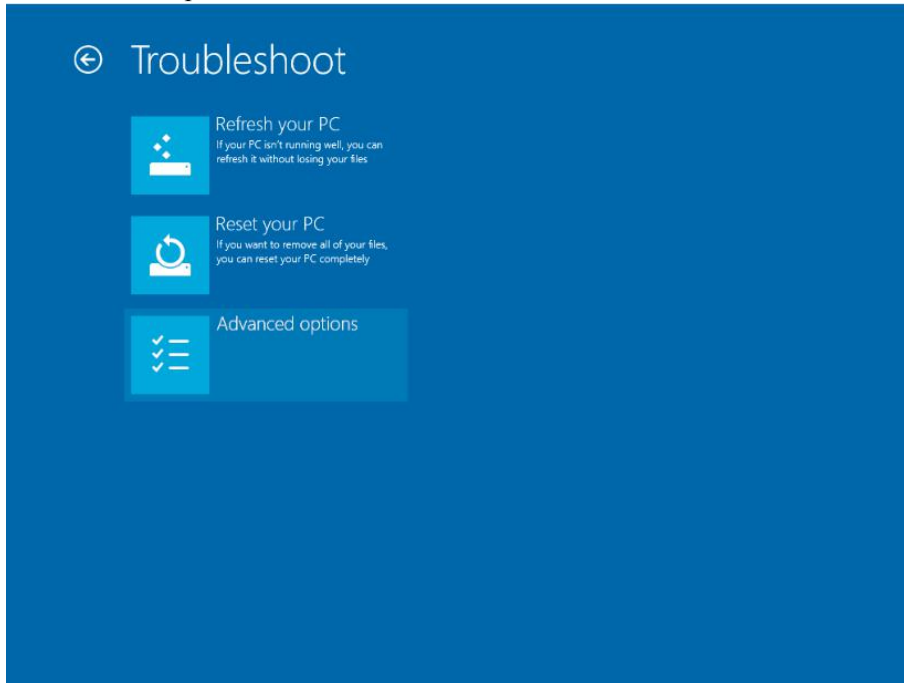

(6) click startup settings

← Advanced options



System Restore
Use a restore point recorded on your PC to restore Windows



Command Prompt
Use the Command Prompt for advanced troubleshooting



System Image Recovery
Recover Windows using a specific system image file



Startup Settings
Change Windows startup behavior



Startup Repair
Fix problems that keep Windows from loading

(7) Click restart

← Startup Settings

Restart to change Windows options such as:

- Enable low-resolution video mode
- Enable debugging mode
- Enable boot logging
- Enable Safe Mode
- Disable driver signature enforcement
- Disable early-launch anti-malware protection
- Disable automatic restart on system failure

Restart

(8) This is the picture after computer restarting.

Choose 7 to forbid driver signature enforcement, then PC restart.

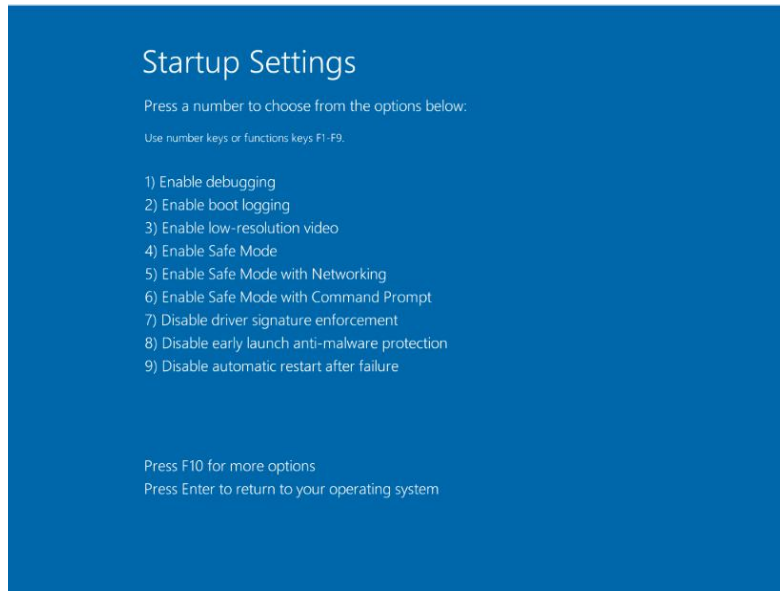

(9) Re-install PLC driver based on Window guidance. Choose driver files in the Win8

It will show below information, choose “install this driver software anyway”

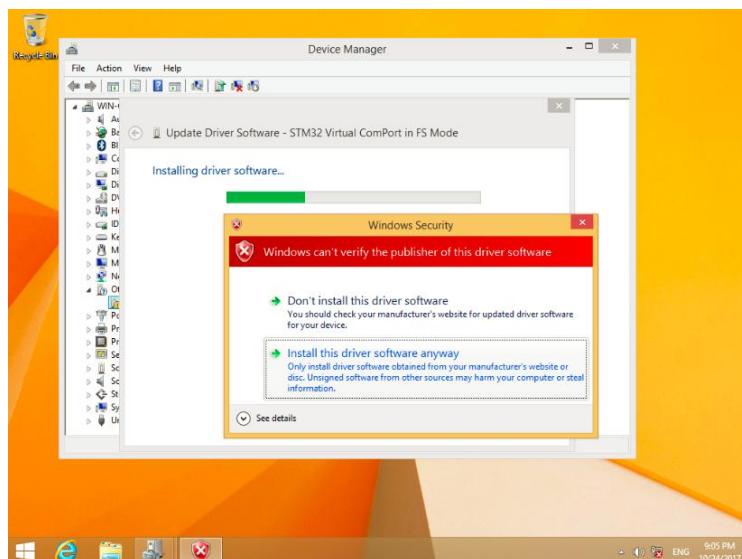

(10) Figure as below after successful

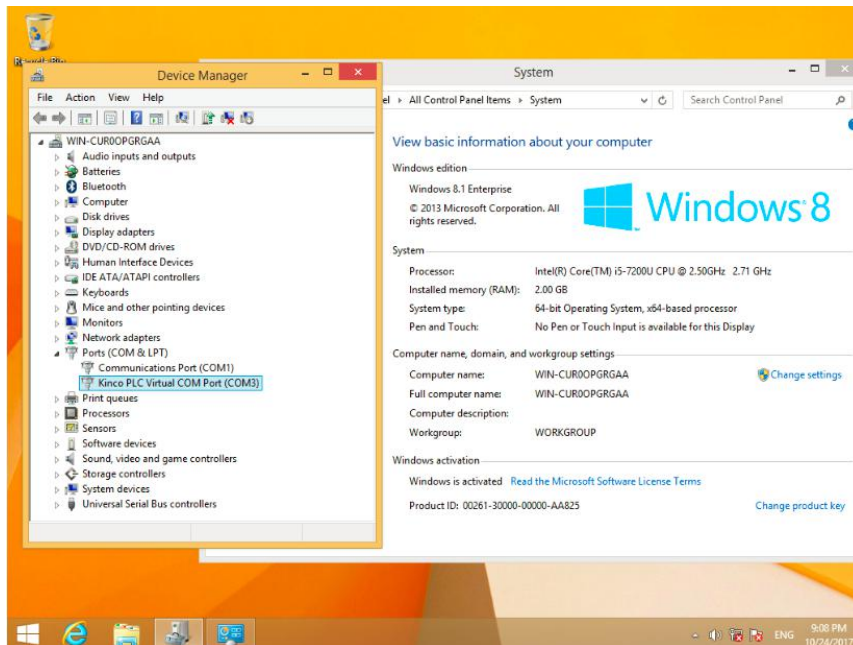
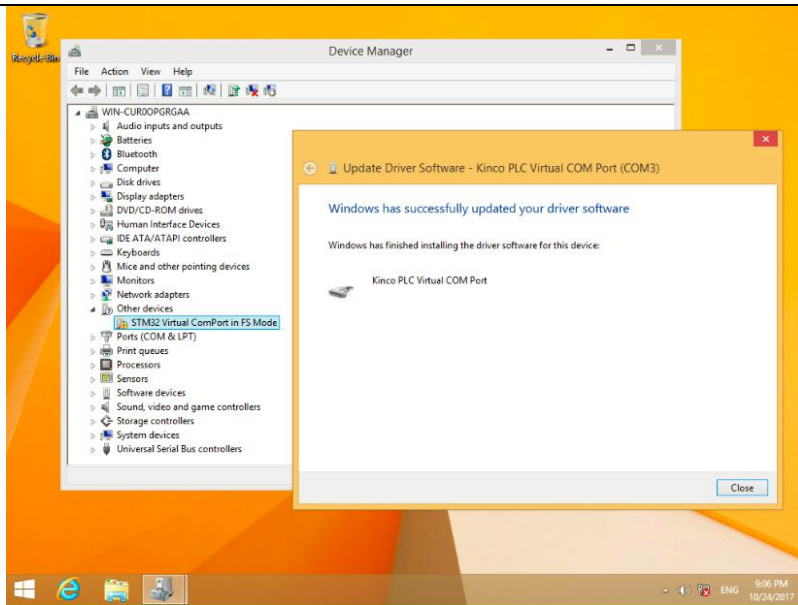

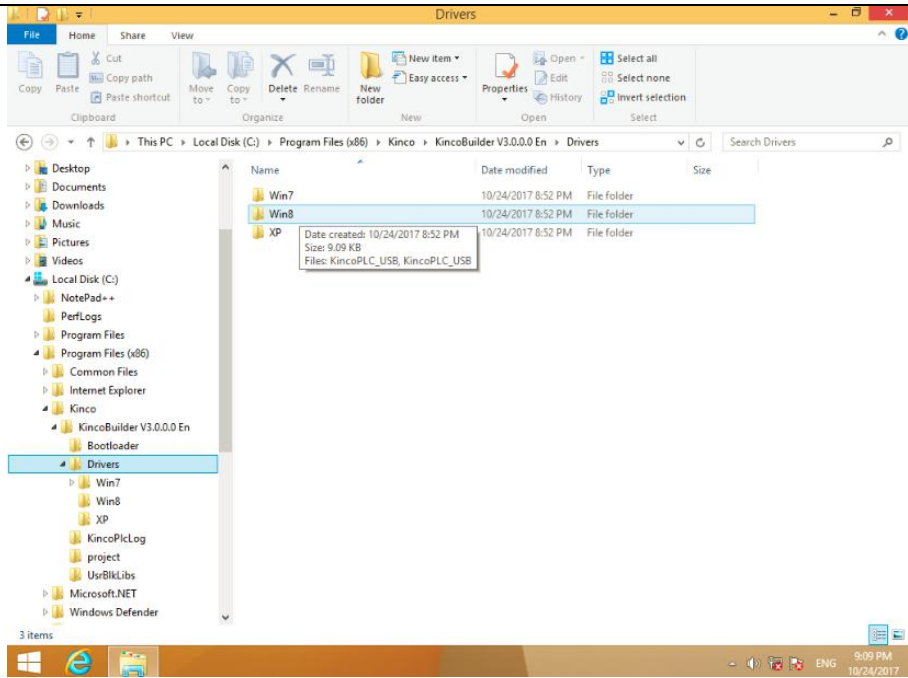

3.2.3 High speed counter

MK070E-33DT provides 4 high speed counters (HSC0~HSC3).High speed counter supports a variety of modes, it can be single-phase, dual-phase (Up/Down), AB phase (1-fold and 4-fold frequency).The maximum counting frequency of the four pulse counters is 50KHz.

CPU	Single phase		AB phase	
	HSC0 and HSC1	HSC2 and HSC3	HSC0 and HSC1	HSC2 and HSC3
MK070E	50K	50K	50K	50K

All high speed counter can support maximum 32 PV and support 32 “CV=PV” interrupts. PV can be set as relative value or absolute value. If it is relative value, then the "CV = PV" interrupt allows the selection to occur cyclically.

3.2.3.1 Operation Modes and Inputs of the High-speed Counters

Input signals of high-speed counter include: clock (input impulse), direction, start and reset.

In different operation modes input signals is different. Please see below:

HSC 0				
Mode	Description	I0.1	I0.0	I0.5
0	Single-phase up/down counter with internal direction control: SM37.3	Clock		
1			Reset	
2			Reset	Start
3	Single-phase up/down counter with external direction control	Clock		Direction
4			Reset	Direction
6	Two-phase counter with up/down clock inputs	Clock Down	Clock Up	
9	A/B phase quadrature counter	Clock A	Clock B	

HSC1					
Mode	Description	I0.4	I0.6	I0.3	I0.2
0	Single-phase up/down counter with internal direction control: SM47.3			Clock	
1		Reset			
2		Reset	Start		
3	Single-phase up/down counter with external direction control			Clock	Direction
4		Reset			Direction
6	Two-phase counter with up/down clock inputs			Clock Down	Clock Up
7		Reset			
9	A/B phase quadrature counter			Clock A	Clock B
10		Reset			

HSC 2			
Mode	Description	I0.4	I0.5
0	Single-phase up/down counter with internal direction control: SM57.3		Clock
9	A/B phase quadrature counter	Clock A	Clock B

HSC 3			
Mode	Description	I0.6	I0.7
0	Single-phase up/down counter with internal direction control:SM127.3		Clock
9	A/B phase quadrature counter	Clock A	Clock B

3.2.3.2 Control Byte and Status Byte

➤ Control Byte

In SM area, each high-speed counter is assigned control byte to save its configuration data: one control word (8 bit), current value and pre-set (double-integer with 32 bit). Initial value of current assigned value. If the current value is written in the high-speed counter, it will start counting from that value. Please see below:

HSC0	HSC1	HSC2	HSC3	Description
SM37.0	SM47.0	SM57.0	SM127.0	Effective electrical level of reset signal: 0=high; 1=low
SM37.1	SM47.1	SM57.1	SM127.1	Effective electrical level to start signal: 0=high; 1=low
SM37.2	SM47.2	SM57.2	SM127.2	Orthogonal counter rate: 0=1x rate; 1=4x rate*
SM37.3	SM47.3	SM57.3	SM127.3	Counting direction:0=Decrease; 1=Increase
SM37.4	SM47.4	SM57.4	SM127.4	Write counting direction in HSC? 0= NO; 1= Yes
SM37.5	SM47.5	SM57.5	SM127.5	Write new pre-set value in HSC? 0= NO; 1= Yes
SM37.6	SM47.6	SM57.6	SM127.6	Write new current value in HSC? 0= NO; 1= Yes
SM37.7	SM47.7	SM57.7	SM127.7	Allow this high-speed counter? 0=NO; 1= YES
HSC0	HSC1	HSC2	HSC3	Description
SMD38	SMD48	SMD58	SMD128	Current value
SMD42	SMD52	SMD62	SMD132	Pre-set value

HSC0	HSC1	HSC2	HSC3	Description
SM141.0	SM151.0	SM161.0	SM171.0	Use multiple preset value:0=No. 1=Yes.
SM141.1	SM151.1	SM161.1	SM171.1	Preset value type:0=Absolute value. 1=Relative value.

SM141.2	SM151.2	SM161.2	SM171.2	Preset value comparison interrupt (“CV=PV”) cyclic execution. 0=No. 1=Yes. Note:Only valid when preset value is relative value.
SM141.3	SM151.3	SM161.3	SM171.3	Reserved
SM141.4	SM151.4	SM161.4	SM171.4	Update multiple PV segment and preset value:0=No. 1=Yes
SM141.5	SM151.5	SM161.5	SM171.5	Reset interrupt variable:0=Yes. 1=No.
SM141.6	SM151.6	SM161.6	SM171.6	Reserved
SM141.7	SM151.7	SM161.7	SM171.7	Reserved
HSC0	HSC1	HSC2	HSC2	Description
SMW142	SMW152	SMW162	SMW172	Starting value of preset value table (It is offset corresponding to VB0),it must be odd value.

It needs to pay attention that not all the control bits of the control byte is suitable for all operation mode. For example, “Counting direction” and “Write counting direction in HSC” can be only used in mode 0,1and 2 (Single-phase up/down counter with internal direction control),if the operation mode is with external direction control, then these two bits will be ignored.

The control byte, current value and preset value are 0 by default after power on.

➤ Status Byte

In SM area, each high-speed counter has a status byte, which indicates the current status of high speed counter.

HSC0	HSC1	HSC2	HSC3	Description
SM36.0	SM46.0	SM56.0	SM126.0	Reserved
SM36.1	SM46.1	SM56.1	SM126.1	Reserved
SM36.2	SM46.2	SM56.2	SM126.2	Reserved
SM36.3	SM46.3	SM56.3	SM126.3	Fault in multiple PV value table:0=No,1=Yes
SM36.4	SM46.4	SM56.4	SM126.4	Reserved
SM36.5	SM46.5	SM56.5	SM126.5	Current counting direction: 0 = Down; 1= Up
SM36.6	SM46.6	SM56.6	SM126.6	Current value equal to preset value: 0 = No,1 = Yes

SM36.7	SM46.7	SM56.7	SM126.7	Current value greater than preset value: 0 = No,1 = Yes
HSC0	HSC1	HSC2	HSC3	Description
SMB140	SMB150	SMB160	SMB170	Current PV segment No.(Start from 0)

3.2.3.3 Preset value (PV value) setting

MK series support up to 32 PV value for each high speed counter, and supports setting PV value as relative value or absolute value. It supports “CV=PV” interrupt cyclic execution.

Follows take HSC0 as example to describe PV value function and setting.

➤ How to select “multiple PV” mode

In the control byte of each high speed counter, there is one control bit for enable multiple preset value.

In HSC0, this control bit is SM141.0.

If SM141.0 is 0,it will use single PV value, same as K5 PLC.SMD42 is for new PV value,SM37.5 is to update this new PV value.

If SM141.0 is 1,it will use multiple PV values. In this situation,SM37.5 and SMD42 is invalid. All the PV values will be in the PV table(SMW142 is for starting address of the table),SM141.4 defines whether it use the data in PV table or not.If SM141.4 is 1,it means when HSC starts, it will get the data from PV table. If SM141.4 is 0,when HSC starts,it will ignore the data in PV table and get the data from last preset value

➤ Multiple PV table

If using PV table,all the PV value will get from PV table.

Each HSC provides one control word which is used to set the starting address of PV table.If using multiple PV,then all PV value will get from PV table.The starting address of PV table is odd address of V area,such as 301(Means VB301).

The format of PV table is as follows.

Offset ⁽¹⁾	Data type	Description
0	BYTE	Quantity of PV
1	DINT	First PV
5	DINT	Second PV
...	DINT	...

-
- (1) All the offset value are the offset bytes related to the table.
 - (2) When it is set as relative value, then the absolute value of PV data must be greater than 1, or PLC will consider the segment of multiple PV finish and count the number of PV according to this (Higher priority than setting quantity of PV).

When it is set as absolute value, the difference between two adjacent PV's absolute value must be greater than 1, or PLC will consider the segment of multiple PV finish and count the number of PV according to this (Higher priority than setting quantity of PV).

- (3) "CV=PV" interrupts must execute in sequence, it means that after the counter reaches the first PV and executes interrupt, then it will compare with the second PV and so forth.
- (4) PV must be set reasonably. Here takes relative value as example, if it is positive counting, PV must be greater than 0, otherwise the "CV=PV" interrupt will never execute. If it is negative counting, PV must be less than 0, otherwise the "CV=PV" interrupt will also never execute.

➤ **Relative value and absolute value**

In the control byte of each high speed counter, there is one control bit which is used to set PV as relative value or absolute value.

For HSC0, the control bit is SM141.1.

If SM141.1 is 0, it means PV is absolute value. When counting value is equal to PV, it will execute "CV=PV" interrupt. For example, if it sets 3 PV values, such as 1000, 2000 and 3000, then when counting value reaches 1000, it will execute the first "CV=PV" interrupt. When the counting value reaches 2000, it will execute the second "CV=PV" interrupt and so forth.

If SM141.1 is 1, it means PV is relative value. If counter takes current counting value as reference, when the value it continues to count is equal to PV, it will execute "CV=PV" interrupt. For example, if it sets 3 PV values, such as 10, 1000 and 1000, and the current counting value is 100 before HSC starts, then when the counting value reaches 110, 1110 and 2110, it will execute corresponding "CV=PV" interrupt.

➤ **"CV=PV" interrupt cyclic execution**

"CV=PV" interrupt cyclic execution is only valid when PV is set as relative value.

If SM141.0 is 0, it means "CV=PV" interrupt only executes once. When all interrupts finish execution, then it will stop. If it needs to execute again, it must modify the related registers and execute HSC instruction again.

If SM141.0 is 1, it means “CV=PВ” interrupt is cyclic execution. When the last PV interrupt finishes execution, PLC will take the current counting value as reference to calculate new value for PV interrupt, then it will start to compare the counting value and execute “CV=PВ” interrupt and so forth. This process will execute cyclically.

For example, it sets 3 PV values, such as 10, 1000 and 1000. And the current counting value is 100 before HSC starts, then the value for every interrupt is as following table.

Current counting value	Interrupt times	First value	Second value	Third value
100	1st time	110	1110	2110
2110	2nd time	2120	3120	4120
4120	3rd time	4130	5130	6130
...	N time

3.2.3.4 “CV=PВ” Event No.

When it uses single PV mode, the HSC will be fully compatible with K5 (Include “CP=PВ” event No.).

When it uses multiple PV mode, the HSC will assign a new event No. for 32 PV, as shown in following table.

High speed counter	Interrupt No.	Description
HSC0	64	“CV=PВ” interrupt of 1st PV
	65	“CV=PВ” interrupt of 2nd PV
 (Plus 1)
	95	“CV=PВ” interrupt of 32nd PV
HSC1	96	“CV=PВ” interrupt of 1st PV
	97	“CV=PВ” interrupt of 2nd PV
 (Plus 1)
	127	“CV=PВ” interrupt of 32nd PV
HSC2	128	“CV=PВ” interrupt of 1st PV
	129	“CV=PВ” interrupt of 2nd PV
 (Plus 1)
	159	“CV=PВ” interrupt of 32nd PV
HSC3	160	“CV=PВ” interrupt of 1st PV
	161	“CV=PВ” interrupt of 2nd PV
 (Plus 1)
	191	“CV=PВ” interrupt of 32nd PV

3.2.3.5 How to use high speed counter

➤ Method 1: Use instructions for programming

- 1) Configure the control byte of HSC and define the current value (i.e. starting value) and the preset value.
- 2) Use HDEF instruction to define the counter and its operation mode.
- 3) (Optional) Use ATCH instruction to define the interrupt routines.
- 4) Use HSC instruction to start the high-speed counter.

➤ Method 2: Use wizard of HSC

In HMI- PLC, it provides configuration wizard for high speed counter. Users can use the wizard to configure all high speed counters and don't need to program. The wizard is as following figure:

After using wizard to configure HSC, user also can use “**Method 1**” to modify the parameters of HSC.

HSC Wizard

HSC: HSC0 Mode: Mode 0 Enable HSC Start method: Run directly at PLC startup

Quadrature rate: 1x Reset signal level: High Start signal level: High

Signal Input: Pulse: IO.1:

Update direction New direction: Up Enable external reset interrupt
 Update count value New count value: 0 Enable external direction-changed interrupt

PV and corresponding interrupts

Enable multiple PVs Relationship between PVs: Absolute Cyclic "CV=PV" interrupts

Multiple PVs settings

Update PV and quantity Quantity: 3 Starting location of PV table (VB): 3009

I...	Address	Value	Event...	Interrupt routine
1	%VD3010	100	64	CNT00 INT_0
2	%VD3014	200	65	CNT01 INT_1
3	%VD3018	300	66	CNT02 INT_2

Up Down Delete

Single PV settings (compatible with RS)

Update preset value (PV) New PV: 2 Enable "CV=PV" interrupt

Interrupt routine:

Apply OK Cancel Help

How to use HSC wizard:

- 1) Select the counter in **【HSC】** .
- 2) Check **【Enable HSC】** , and then continue following configuration.
- 3) Select counter mode in **【Mode】** .
- 4) Select the starting mode in **【Start method】** .

There are two starting method:

“Using HSC instruction”: If selecting this method, then it needs to execute HSC instruction to start the HSC. Before executing HSC instruction, it doesn't need to configure the registers and execute HDEF instruction.

“Run directly at PLC startup”: If selecting this method, then the HSC will start automatically after PLC power on without executing any instructions.

- 5) If user needs to use multiple PV mode, then check **【Enable multiple PVs】** and continue to configure all PV values and related ‘Value’ and ‘Interrupt subroutine’. If checking **【Update PV and quantity】** , then it can adjust the value in **【Quantity】** to modify the number of PV.
- 6) If user needs to use single PV mode, then check **【Update preset value(PV)】** in ‘Single PV settings’ and modify the PV value and related interrupt subroutine.
- 7) For other options, please refer to the descriptions to HSC.

3.2.4 How to use high speed pulse output

MK070E also provides 4 high speed pulse outputs(Q0.0,Q0.1,Q0.4andQ0.5)and all support PTO(pulse train) and PWM(pulse width modulation) output.The highest frequency of each series of CPU is as follows(The resistor of load should be less than 3KΩ).

CPU	Q0.0	Q0.1	Q0.4	Q0.5
MK070E	50K	50K	50K	10K

For position control instruction,MK070E have one position output channel for every high speed pulse output .Meanwhile one position enable control bit in SM area.

	Q0.0	Q0.1	Q0.4	Q0.5
Position output channel	Q0.2	Q0.3	Q0.6	Q0.7
Position enable control bit	SM201.3	SM231.3	SM251.3	SM221.3

Position output channel output motor position signal. Forward is 0, rollback is 1.

Position output enable control bit forbid or allow the involved output channel. The position enable control bit have highest priority. If it is forbidden, position control instruction won't output position control signal. The involved output channel will be used as common DO.

3.2.4.1 High speed pulse output instruction

MK070E provides 3types of instructions for high speed pulse output.

- 1) PLS: it is used to output PTO(Single segment or multiple segments) and PWM.
- 2) Position control: There are 5 instructions, include PREL(Relative positioning), PABS(Absolute positioning) ,PHOME(Homing), PJOG(Jogging) and PSTOP(Emergency stop). User can use these instructions to achieve positioning control easily .Note: When using position control instructions, the frequency of output pulse must be not less than 125Hz.
- 3) Following instruction PFLO_F: There are parameters such as input frequency(F),electronic gear ratio($NUME$ 、 $DENOM$), pulse number($COUNT$) and so on, these parameters can be used as variable. The frequency of pulse output is equal to F multiple by electronic gear ratio. When the pulse number reaches the value $COUNT$, then it will stop output and set $DONE$ bit. Note: When using following instruction, the frequency of output pulse must be not less than 30Hz.

3.2.4.2 How to use PLS instruction

PLS instruction can implement PTO and PWM output function.

- PTO: Pulse Train Output.
- PWM: Pulse-Width Modulation.

➤ Descriptions

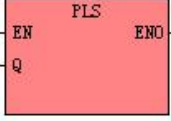
	Name	Usage	Group	Suitable for
LD	PLS			K2 K5 KW
IL	PLS	PLS Q	U	KS HP MK

Operands	Input/Output	Data Type	Description
Q	Input	INT	Constant (0、1、2 or 3)

The PLS instruction is used to load the corresponding configurations of the PTO/PWM from the specified SM registers and then start outputting pulse until it finish outputting pulse. The pulse output channel is specified by parameter Q, 0 means Q0.0, 1 means Q0.1, 2 means Q0.4, 3 means Q0.5.

Note: In user program, it only needs to execute PLS instruction once when it is required. It is suggested to use edge instruction to execute PLS instruction. If executing PLS executing all the time, then it can't output normally.

- LD

If EN is 1, then PLS is executed.

- IL

If CR is 1, then PLS is executed. It won't influence the value of CR.

3.2.4.2.1 High-speed Pulse Output Function of MK series

MK070E provides 4 PTO/PWM pulse generators that can be used to output PTO/PWM. Therefore, one generator is assigned to Q0.0, called PWM0 or PTO0; the second one is assigned to Q0.1, called PWM1 or PTO1, the third one is assigned to Q0.4, called PWM2 or PTO2, and the fourth one is assigned to Q0.5, called PWM3 or PTO3.

The PTO/PWM pulse generators and the DO mapping area share the memory address Q0.0, Q0.1, Q0.4 and Q0.5. When the user program executes the high speed pulse output

instructions, then the PTO/PWM generator controls the output and prohibits the normal use of this output channel.

Some registers are provided in SM area for each PTO/PWM generator. When user needs to use high speed pulse output function, it needs to configure these memories, and then executes PLS instruction to implement desired operation of PTO/PWM.



Notice: Make sure not to use the PTO and PWM functions if Q0.0, Q0.1, Q0.4 and Q0.5 are relay-output!

➤ **PWM**

PWM provides a continuous pulse output with a variable duty cycle, and you can control the cycle time and the pulse width.

The unit of cycle time and pulse width time is microsecond(us) or millisecond(ms). The maximum value of cycle time is 65535. If the pulse width time is greater than the cycle time value, the duty cycle is set to be 100% automatically and the output is on continuously. If the pulse width time is 0, the duty cycle is set to be 0% and the output is off.

➤ **PTO**

PTO provides a square wave (50% duty cycle) output, and you can control the cycle time and the number of the output pulses. The unit of cycle time is microsecond(us) or millisecond(ms). The maximum value of cycle time is 65535. The range of pulse number is 2~4,294,967,295. If the specified pulse number is less than 2, then MK070E will set related error bit and prohibit the output.

PTO function provides single segment of pulse and multiple segment of pulse.

- **Single segment pulse**

In single segment pulse mode, it only executes pulse train output once after executing PLS instruction.

- **Multiple segment pulse**

In multi-segment pulse mode, CPU automatically reads the configurations of each PTO segment from a profile table located in V area and executes the related PTO segment.

The length of each segment is 8 bytes, including a cycle time value (16-bit, WORD), a reserved value (It is not used now, 16-bit, INT), and a pulse number value (32-bit, DWORD). Thereof, all the pulse output frequency are the same in same segment. It uses PLS instruction to start multiple segment pulse.

In this mode, the starting address of the profile table is stored in SMW168 (corresponding to PTO0), SMW178(corresponding to PTO1), SMW218(corresponding to PTO2) and SMW248(corresponding to PTO3).Time base is configured by SM67.3 (corresponding to PTO0) ,SM77.3 (corresponding to PTO1),SM97.3 (corresponding to PTO2) and SM107.3 (corresponding to PTO3). The time base can be in either microsecond or millisecond. All cycle values in the profile table must use same time base, and cannot be modified when the profile is executing.

The following table describes the format of the profile table.

Byte offset ¹	Length	Segment	Description
0	8-bit		The number of segments (1 to 64)
1	16-bit	1	Initial cycle time (2 to 65535 times of the time base)
3	16-bit		Reserved
5	32-bit		Pulse number(1 to 4,294,967,295)
9	16-bit	2	Initial cycle time (2 to 65535 times of the time base)
11	16-bit		Reserved
13	32-bit		Pulse number(1 to 4,294,967,295)
...	

1 All the offsets in this column are relative to the starting position of the profile table.



Notice: the starting position of the profile table must be an odd address in V area, e.g. VB3001.

3.2.4.2.2 PTO/PWM Register

Each PTO/PWM generator is provided with some registers in SM area to store its configurations, as shown in following table.

Q0.0	Q0.1	Q0.4	Q0.5	Description
SM67.0	SM77.0	SM97.0	SM107.0	PTO/PWM Whether to update the cycle time: 0=No;1=Yes
SM67.1	SM77.1	SM97.1	SM107.1	PWM Whether to update pulse width time: 0=No;1=Yes
SM67.2	SM77.2	SM97.2	SM107.2	PTO Whether to update the pulse number: 0=No;1=Yes

SM67.3	SM77.3	SM97.3	SM107.3	PTO/PWM	Time base: 0=1 μ s; 1=1ms
SM67.4	SM77.4	SM97.4	SM107.4	PWM	Update method: 0 = asynchronous update; 1 = synchronous update
SM67.5	SM77.5	SM97.5	SM107.5	PTO	Operation mode: 0 = single segment; 1 = multiple segment
SM67.6	SM77.6	SM97.6	SM107.6	Function selection: 0= PTO; 1=PWM	
SM67.7	SM77.7	SM97.7	SM107.7	PTO/PWM	Enable/disable: 0=disable; 1= enable
Q0.0	Q0.1	Q0.4	Q0.5	Description	
SMW68	SMW78	SMW98	SMW108	PTO/PWM	Cycle time, Range:2~65535
SMW70	SMW80	SMW100	SMW110	PWM	Pulse width, Range: 0~65535
SMD72	SMD82	SMD102	SMD112	PTO	Pulse number, Range:1~4,294,967,295
SMW168	SMW178	SMW218	SMW248	The starting location of the profile table (byte offset from V0),for multi-segment PTO operation only.	

All the default value for control byte, cycle time and pulse number are 0. The way to modify configuration of PTO/PWM is that configure related control registers first, if it is PTO multiple segment pulse, it also needs to configure profile table, and then execute PLS instruction.

Each PTO/PWM generator also provides a status bytes in SM area, user can get the status information of PTO/PWM generator from the status bytes, as shown in following table.

Q0.0	Q0.1	Q0.4	Q0.5	Description
SM66.0	SM76.0	SM96.0	SM106.0	Reserved
SM66.1	SM76.1	SM96.1	SM106.1	Reserved
SM66.2	SM76.2	SM96.2	SM106.2	Reserved
SM66.3	SM76.3	SM96.3	SM106.3	PWM idle: 0=No, 1=Yes

SM66.4	SM76.4	SM96.4	SM106.4	Whether the cycle time or pulse number of PTO is wrong: 0=No, 1=Yes Note: Cycle time and pulse number must be greater than 1.
SM66.5	SM76.5	SM96.5	SM106.5	PTO profile terminated due to user command: 0=No, 1=Yes
SM66.6	SM76.6	SM96.6	SM106.6	Reserved
SM66.7	SM76.7	SM96.7	SM106.7	PTO idle: 0=No, 1=Yes

The PTO idle bit or PWM idle bit indicate the completion of the PTO or PWM output.

3.2.4.2.3 PTO Operations

The following takes PTO0 as an example to introduce how to configure and operate the PTO/PWM generator in the user program.

There are two procedures for using PTO: Configure related control registers and initialize PTO. Execute PLS instruction.

Use SM0.1 (the first scan memory bit) to call a subroutine that contains the initialization instructions. Since SM0.1 is used, the subroutine shall be executed only once, and this reduces CPU scan time and provides a better program structure.

➤ Execute the PTO (Single-Segment Operation)

- 1) Set control byte SMB67 according to the desired operation.

For example, SMB67 = B#16#85 indicates:

- Enable the PTO/PWM function
 - Select PTO operation
 - Select 1 μ s as the time base
 - Allow updating the pulse number and cycling time.
- 2) Set SMW68 according to desired cycle time.
 - 3) Set SMD72 according to desired pulse number.
 - 4) (Optional) use ATCH to attach the PTO0-complete event (event 28) to an interrupt routine to respond in real time to a PTO0-complete event.

-
- 5) Execute the *PLS* instruction to configure PTO0 and start it.

➤ **Changing the PTO Cycle Time (Single-Segment Operation)**

Follow these steps to change the PTO cycle time.

- 1) Set control byte SMB67 according to the desired operation.

For example, SMB67 = B#16#81 indicates:

- Enable the PTO/PWM function
 - Select PTO operation
 - Select 1 μ s as the time base
 - Allow updating the cycle time value.
- 2) Set SMW68 according to desired cycle time.
 - 3) Execute the *PLS* instruction to configure PTO0 and start it, then a new PTO with the updated cycle time shall be generated.

➤ **Changing the PTO Pulse Number(Single-Segment Operation)**

Follow these steps to change the PTO pulse count:

- 1) Set control byte SMB67 according to the desired operation.

For example, SMB67 = B#16#84 indicates:

- Enable the PTO/PWM function
 - Select PTO operation
 - Select 1 μ s as the time base
 - Allow updating the pulse number
- 2) Set SMD72 according to desired pulse number.
 - 3) Execute the *PLS* instruction to configure PTO0 and start it, then a new PTO with the updated pulse number shall be generated.

➤ **Execute the PTO (Multiple-Segment Operation)**

- 1) Set control byte SMB67 according to the desired operation.

For example, SMB67 = B#16#A0 indicates:

-
- Enable the PTO/PWM function
 - Select PTO operation
 - Select multi-segment operation
 - Select 1 μ s as the time base
- 2) Set an odd number as the starting position of the profile table into SMW168.
 - 3) Use V area to configure the profile table.
 - 4) (Optional) Use ATCH to attach the PTO0-complete event (event 28) to an interrupt routine to respond in real time to a PTO0-complete event.
 - 5) Execute the *PLS* instruction to configure PTO0 and start it.

3.2.4.2.4 PWM Operations

Following takes PWM0 as an example to introduce how to configure and operate the PTO/PWM generator in the user program.

There are two procedures for using PWM: Configure related control registers and initialize PTO. Execute PLS instruction.

Use SM0.1 (the first scan memory bit) to call a subroutine that contains the initialization instructions. Since SM0.1 is used, the subroutine shall be executed only once, and this reduces CPU scan time and provides a better program structure.

➤ **Execute PWM**

- 1) Set control byte SMB67 according to the desired operation.

For example, SMB67 = B#16#D3 indicates:

- Enable the PTO/PWM function
 - Select PWM operation
 - Select 1 μ s as the time base
 - Allow updating the pulse width value and cycle time value
- 2) Set SMW68 according to desired cycle time.
 - 3) Set SMW70 according to desired pulse width.
 - 4) Execute the *PLS* instruction to configure PWM0 and start it.

➤ Changing the Pulse Width for the PWM Output

The following steps describes how to change PWM output pulse width.

- 1) Set control byte SMB67 according to the desired operation.

For example, SMB67 = B#16#D2 indicates:

- Enable the PTO/PWM function
- Select PWM operation
- Select 1 μ s as the time base
- Allow updating the pulse width value and cycle time value

- 2) Set SMW70 according to desired pulse width.

- 3) Execute the *PLS* instruction to configure PWM0 and start it

3.2.5 How to Use Position Control Instructions

3.2.5.1 How to Modify the Current Value of Position Control Instructions

➤ Control Registers and Status Registers

For the Position Control instructions, Kinco-K2 specifies a control byte for each high-speed output channel to store its configurations. Besides, it assigns a current value register(DINT) to store the pulse number which has outputted currently (This value will increase when run forward and decrease when run reverse).The following table describes the control byte and the current value.

Q0.0	Q0.1	Q0.4	Q0.5	Description
SMD212	SMD242	SMD262	SMD226	Read only. Current value (Increase when run forward, decrease when run reverse).It indicates the pulse number which has already outputted.
SMD208	SMD238	SDM258	SMD222	Read/Write. New current value. Use to modify the current value together with specific control bit.
Q0.0	Q0.1	Q0.4	Q0.5	Description

SM201.7	SM231.7	SM251.7	SM221.7	Read/Write. Emergency-Stop bit. If this bit is 1, no position control instructions can be executed. When executing the PSTOP instruction, this bit is set to 1 automatically, and it must be reset in the program..
SM201.6	SM231.6	SM251.6	SM221.6	Read/Write. Reset the current value or not 1 --- Clear the current value. 0 --- Maintain the current value.
SM201.5	SM231.5	SM251.5	SM221.5	Reserved
SM201.4	SM231.4	SM251.4	SM221.4	Read/Write. Use to modify current value. 1 - Modify current value. 0 - Maintain the current value.
SM201.3	SM231.3	SM251.3	SM221.3	Read/Write. Direction control bit. 1 --- Disable the direction output channel, it will be used as normal output. 0 --- Enable the direction output channel.
SM201.0 ~ SM201.2	SM231.0 ~ SM231.2	SM251.0 ~ SM251.2	SM221.0 ~ SM221.2	Reserved

➤ How to modify current value

Each high speed output channel has one register for current value, they are SMD212,SMD242,SMD262and SMD226.The outputted pulse number are stored in these registers. Current value registers are read only, if user needs to modify the current value, it can use following methods.

• Method 1

User reset bit to clear current value.

The reset bits for 4 output channels are SM201.6, SM231.6, SM251.6 and SM221.6.

When the reset bit is 1, PLC will set the current value as 0.Therefore, t only needs one scan time for the reset bit to activate. When it needs to use this bit, try to avoid to keep this bit always 1 and also and also avoid to set this bit while the Position Control instruction (Include PHOME, PREL, PABS, JOG and PFLO_F) is executing, otherwise the counting value may be wrong.

Following takes channel 0 as example to describe how to reset current value.

(* Network 0 *)

(*Based on homing signal, when it moves to homing, it requires to clear current value*)

LD %SM0.0

PHOME

0, %M0.0, %M0.1, %M0.2, %VW0, %VW2, %VW4, %VD6, %VW10, %M0.4, %M0.5, %M
B1

(* Network 1 *)

(*After PHOME finishing, it uses finishing bit “DONE” to clear current value*)

LD %M0.4

R_TRIG

ST %SM201.6

- **Method 2**

Modify current value by using following registers.

Q0.0	Q0.1	Q0.4	Q0.5	Description
SMD208	SMD238	SDM258	SMD222	Read/Write. New current value. Use to modify the current value together with specific control bit.
SM201.4	SM231.4	SM251.4	SM221.4	Read/Write. Use to modify current value. 1 - Modify current value. 0 - Maintain the current value.

Here takes channel 0 as example to describe the method: If SM201.4 is 0, then it will maintain the current value SMD212. If SM201.4 is 1, then it will move the value of SMD208 to SMD212. When it needs to use this bit, avoid to keep this bit always 1 and also avoid to set this bit while the Position Control instruction (Include PHOME, PREL, PABS, JOG and PFLO_F) is executing, otherwise the counting value may be wrong.

Following takes channel 0 as example to describe how to modify current value:

(* Network 0 *)

(*Based on homing signal, hen it moves to homing, t requires to set current value as 100.*)

LD %SM0.0

PHOME

0, %M0.0, %M0.1, %M0.2, %VW0, %VW2, %VW4, %VD6, %VW10, %M0.4, %M0.5, %M
B1

(* Network 1 *)

(*When PHOME instruction finishing, it uses finishing bit DONE to modify current value.*)

LD %M0.4

R_TRIG

MOVE DI#100, %SMD208

ST %SM201.4

3.2.5.2 Can it change maximum output frequency when position control instruction is executing?

PREL (Relative position) and PABS (Absolute position) will not change maximum output frequency when it is executing. It will read the parameters minimum frequency, maximum frequency and acceleration/deceleration time parameters when it starts, and calculates suitable acceleration/deceleration segments according to the value of these parameters, then it will start outputting pulse. During pulse outputting, PREL and PABS will not read the parameters above again, therefore, changing these parameters will not affect the pulse output.

PJOG (Jogging) will read pulse input frequency(MAXF) all the time when it is executing, and adjust the pulse output frequency according to new setting frequency.

PHOME (Homing) will read the maximum frequency (MAXF) all the time when it is running at maximum frequency but hasn't found homing signal, and calculate acceleration or deceleration segment automatically according the new setting frequency, then it will accelerate or decelerate to new frequency to output pulse.

3.3 The use of analog quantities

The MK070E has 3 analog channels, 2*AI (IV), 1*AO (IV). The signal form of the channel is configured in the programming software. The channels allow for mixed access to different signals.

3.3.1 Wiring diagram

Please refer to [2.2 Wiring diagram](#)

3.3.2 Measurement Ranges and The measured value Representation

The input signal in each channel will sample ADC and counter. The results will be send to

CPU AI area from expansion CAN. Then user programming can visit it.

All the signal types have detection range. If the value is over range, the modules will warn, Meanwhile it will send problem file to CPU by expansion module. **Pls connect all the channels that is not used, also setup signal type to 【0-10V】 ,then these channels won't warn.**

In the following table, I stand for current, while V represents input voltage value, unit V.

Measurement Method	Measurement Range	Measured value
4-20mA	3.92-20.4mA	I×1000
0-20mA	0-20.4mA	
1-5V	0.96-5.1V	V×1000
0-10V	0-10.2V	

In the following table, T represents measured temperature, unit: ° C.

Measurement Method	Measurement Range	Measured value
Type J	-210~1200°C	T×10
Type K	-270~1300°C	
Type E	-270~1000°C	
Type S	-50~1600°C	

The AQ output value specified in the user program would firstly sent to the corresponding AO module through the expansion bus, and then calculated, transformed, and output on the specified channel through the DAC.

The signal output range are limited.If the user assign an output value over the limitation,The actual output value would keep maintain on the upper or lower limit value.

The following table are the range of signal.Among them,I stand for Actual Current,V stand for Actual Voltage.

Signal	Output range	User assigned value in program
4-20mA	3.92-20.4mA	I×1000

0-20mA	0-20.4mA	V×1000
1-5V	0.96-5.1V	
0-10V	0-10.2V	

3.3.3 Configuration in software

Hardware configuration in the software can be used to configure analog channel parameters.

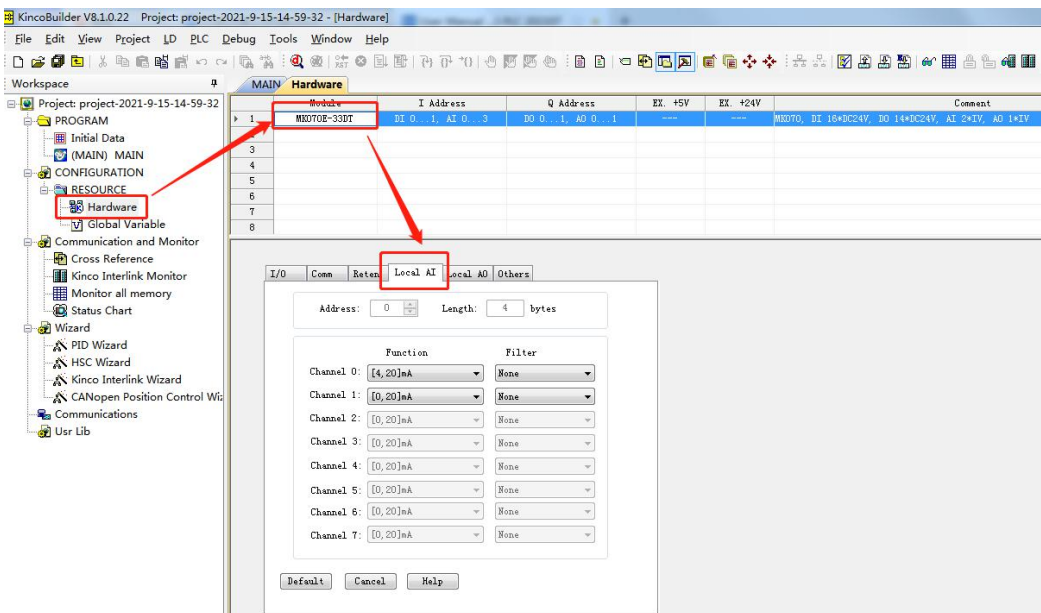

➤ Address

- **The starting address :** Specifies the start byte address that the module occupies in the address space in the AI region (That's the address of the first channel) .

Each AI point takes 2 bytes in the AI region.therefore, The address must be an even number.

- **length :** The length of the address space occupied by this module.This is a fixed value, depending on the number of AI channels on the module.

As above, The starting address of CPU module is specified as %AIW0, The module has two AI channels, So the addresses of its two channels in turn are %AIW0、%AIW2.

➤ **Channel Settings**

- **Signal form :** Select the type of input signal for each channel. The sample values are automatically converted linearly within the CPU, The data conversion format please refer to [3.3.2 Measurement Ranges and The measured value Representation](#)
- **Filter way:** Select software filters for each channel.

The measured value can be stabilized by using a filter for the rapidly changing analog signal.

Note: If the system needs to respond quickly to an AI signal, the software filter at that point should not be enabled.

The input sampling of software filter adopts sliding mode. The software filter has the following options:

- ✓ None --- Software filters are not enabled.
- ✓ Arithmetic mean --- Take the arithmetic mean value of the signal sampling value.
- ✓ Median average --- After the maximum and minimum values are removed from the sample values, the remaining Numbers are averaged.