

DVP04AD-H2 Analog Input Module

Instruction Sheet



Warning

- ✓ Please read this instruction carefully before use.
- ✓ Switch off the power before wiring.
- ✓ DVP04AD-H2 is an OPEN-TYPE device and therefore should be installed in an enclosure free of airborne dust, humidity, electric shock and vibration. The enclosure should prevent non-maintenance staff from operating the device (e.g. key or specific tools are required to open the enclosure) in case danger and damage on the device may occur.
- ✓ DO NOT connect input AC power supply to any of the I/O terminals; otherwise serious damage may occur. Check all the wiring again before switching on the power.
- ✓ DO NOT touch any terminal when the power is switched on. DO NOT touch any internal circuit in 1 minute after the power is switched off.
- ✓ Make sure the ground terminal ⊕ is correctly grounded in order to prevent electromagnetic interference.

1 Introduction

1.1 Model Explanation & Peripherals

❖ Thank you for choosing Delta DVP series. DVP04AD-H2 is able to receive 4 points of analog input signals (voltage or current) and convert them into 14-bit digital signals. Besides, through FROM/TO instructions in DVP-EH2 MPU program, DVP04AD-H2 is able to read and write the data in the module. There are 49 16-bit control registers (CR) in DVP04AD-H2.

❖ The user can select voltage or current output by wiring. Range of voltage output: ±10VDC (resolution: 1.25mV). Range of current output: ±20mA (resolution: 5µA).

❖ Nameplate Explanation

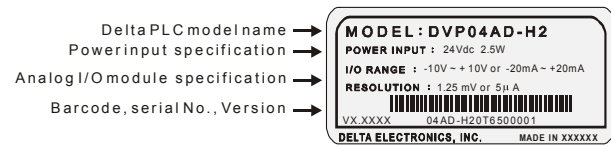

❖ Model/Serial No. Explanation

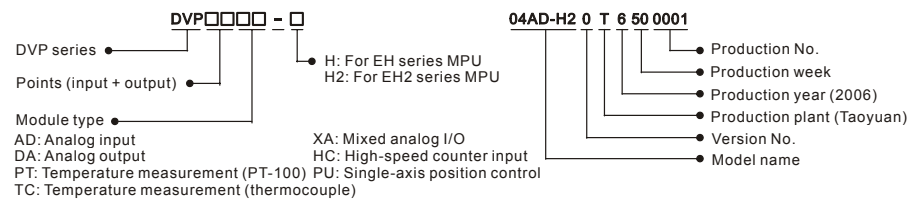

1.2 Product Profile (Indicators, Terminal Block, I/O Terminals)

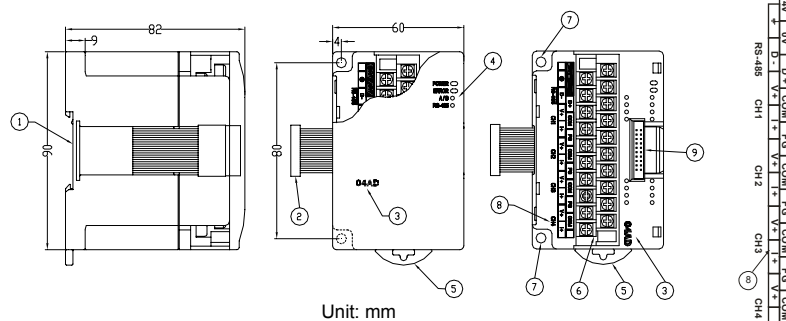

- | | |
|---|---------------------------------------|
| ① DIN rail (35mm) | ⑥ Terminals |
| ② Connection port for extension modules | ⑦ Mounting hole |
| ③ Model name | ⑧ I/O terminals |
| ④ POWER, ERROR, A/D indicator | ⑨ Mounting port for extension modules |
| ⑤ DIN rail clip | |

1.3 External Wiring

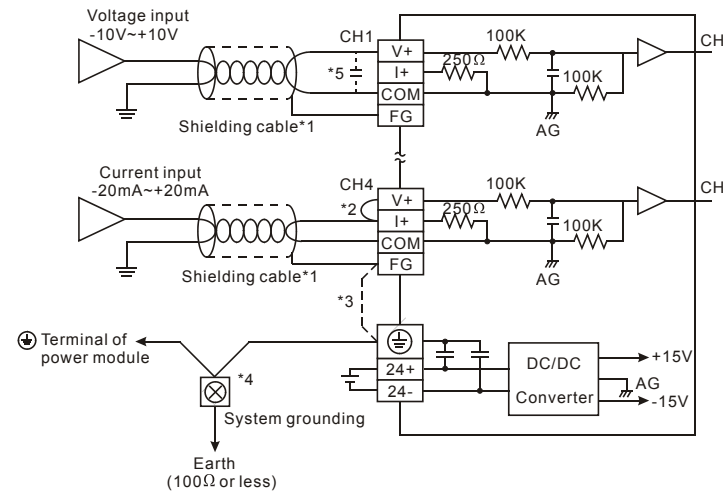

- *1. When performing analog input, please isolate other power wirings.
- *2. If the ripples at the loaded input terminal are too significant that causes noise interference on the wiring, connect the wiring to 0.1 ~ 0.47µF 25V capacitor.
- *3. Please connect the ⊕ terminal on both the power modules and DVP04AD-H2 to the system earth point and ground the system contact or connect it to the cover of power distribution cabinet.

NOTE: DO NOT wire empty terminals ⊖

2 Specifications

2.1. Functions

Analog/Digital (A/D) Module	Voltage input	Current input
Power supply voltage	24 VDC (20.4VDC ~ 28.8VDC) (-15% ~ +20%)	
Analog input channel	4 channels/module	
Range of analog input	±10V	±20mA
Range of digital conversion	±8,000	±4,000
Resolution	14 bits (1 _{LSB} = 2.5mV)	13 bits (1 _{LSB} = 5µA)
Input impedance	0.5Ω or lower	
Overall accuracy	±0.5% when in full scale (25°C, 77°F) ±1% when in full scale within the range of 0 ~ 55°C, 32 ~ 131°F	
Responding time	3ms × the number of channels	
Isolation	Internal circuit and analog output terminals are isolated by optical coupler. No isolation among analog channels.	
Range of absolute input	±15V	±32mA
Digital data format	13 significant bits out of 16 bits are available; in 2's complement	
Average function	Yes. Available for setting up in CR#2 ~ CR#5; range: K1 ~ K20.	
Self-diagnosis	Upper and lower bound detection/channel	
Communication mode (RS-485)	ASCII/RTU mode. Communication speed: 4,800/9,600/19,200/38,400/57,600/115,200 bps ASCII data format: 7-bit, Even bit, 1 stop bit (7, E, 1) RTU data format: 8-bit, Even bit, 1 stop bit (8, E, 1) RS-485 cannot be used when connected to PLC MPU.	
When connected to DVP-PLC MPU in series	The modules are numbered from 0 to 7 automatically by their distance from MPU. No.0 is the closest to MPU and No.7 is the furthest. Maximum 8 modules are allowed to connect to MPU and will not occupy any digital I/O points.	

2.2. Others

Power Supply	
Max. rated power consumption	24VDC (20.4VDC ~ 28.8VDC) (-15% ~ +20%), 2.5W supplied by external power
Environment	
Operation/storage	Operation: 0°C ~ 55°C (temperature); 50 ~ 95% (humidity); pollution degree 2 Storage: -40°C ~ 70°C (temperature); 5 ~ 95% (humidity)
Vibration/shock immunity	International standards: IEC1131-2, IEC 68-2-6 (TEST Fc)/IEC1131-2 & IEC 68-2-27 (TEST Ea)

3 Control Registers

CR#	RS-485 Parameter address	DVP04AD-H2		Description																
		Latched	Register content	b15	b14	b13	b12	b11	b10	b9	b8	b7	b6	b5	b4	b3	b2	b1	b0	
#0	H'4000	○	R	Model name	Set up by the system. DVP04AD-H2 model code = H'6400 reserved CH4 CH3 CH2 CH1															
#1	H'4001	○	R/W	Input mode setting	Input mode: Default = H'0000 Mode 0: Voltage input (-10V ~ +10V) Mode 1: Voltage input (-6V ~ +10V) Mode 2: Current input (-12mA ~ +20mA) Mode 3: Current input (-20mA ~ +20mA)															
#2	H'4002	○	R/W	CH1 average time	Range of settings in CH1 ~ CH4: K1 ~ K20. Default = K10.															
#3	H'4003	○	R/W	CH2 average time																
#4	H'4004	○	R/W	CH3 average time																
#5	H'4005	○	R/W	CH4 average time																
#6	H'4006	X	R	CH1 input average	Average of input signals at CH1 ~ CH4															
#7	H'4007	X	R	CH2 input average																
#8	H'4008	X	R	CH3 input average																
#9	H'4009	X	R	CH4 input average																
#10~#11				Reserved																
#12	H'400C	X	R	CH1 input present value	Present value of input signals at CH1 ~ CH4															
#13	H'400D	X	R	CH2 input present value																
#14	H'400E	X	R	CH3 input present value																
#15	H'400F	X	R	CH4 input present value																
#16~#17				Reserved																
#18	H'4012	○	R/W	Adjusted OFFSET value of CH1	OFFSET settings at CH1 ~ CH4. Default = K0; Unit: LSB When voltage input, range: K-4,000 ~ K4,000 When current input, range: K-4,000 ~ K4,000															
#19	H'4013	○	R/W	Adjusted OFFSET value of CH2																
#20	H'4014	○	R/W	Adjusted OFFSET value of CH3																
#21	H'4015	○	R/W	Adjusted OFFSET value of CH4																
#22~#23				Reserved																
#24	H'4018	○	R/W	Adjusted GAIN value of CH1	GAIN settings at CH1 ~ CH4. Default = K4,000; Unit: LSB When voltage input, range: K-3,200 ~ K16,000 When current input, range: K-3,200 ~ K10,400															
#25	H'4019	○	R/W	Adjusted GAIN value of CH2																
#26	H'401A	○	R/W	Adjusted GAIN value of CH3																
#27	H'401B	○	R/W	Adjusted GAIN value of CH4																
#28~#29				Reserved																
#30	H'401E	X	R	Error status	Register for storing all error status. See the table of error status for more information.															
#31	H'401F	○	R/W	Communication address setting	For setting RS-485 communication address. Range: 01 ~ 255. Default = K1															
#32	H'4020	○	R/W	Communication speed (baud rate) setting	For setting up communication speed: 4,800/9,600/19,200/38,400/57,600/115,200bps ASCII data format: 7-bit, Even bit, 1 stop bit (7, E, 1) RTU data format: 8-bit, Even bit, 1 stop bit (8, E, 1) Default = H'0002 b0: 4,800bps b1: 9,600bps (default) b2: 19,200bps b3: 38,400bps b4: 57,600bps b5: 115,200bps b6 ~ b13: reserved b14: High/low bit exchange of CRC checksum (only valid in RTU mode) b15: Switch between ASCII/RTU mode; 0 = ASCII mode (default)															
#33	H'4021	○	R/W	Returning to default setting; OFFSET/GAIN tuning authorization	b15 b14 b13 b12 b11 b10 b9 b8 b7 b6 b5 b4 b3 b2 b1 b0 reserved CH4 CH3 CH2 CH1 Default = H'0000. Take the setting of CH1 for example: 1. When b0 = 0, the user is allowed to tune CR#18 (OFFSET) and CR#24 (GAIN) of CH1. When b0 = 1, the user is not allowed to tune CR#18 (OFFSET) and CR#24 (GAIN) of CH1. 2. b1 represents whether the OFFSET/GAIN tuning registers are latched. b1 = 0 (default, latched); b1 = 1 (non-latched) 3. When b2 = 1, all settings will return to default values.															
#34	H'4022	○	R	Firmware version	Displaying the current firmware version in hex; e.g. version 1.0A is indicated as H'010A.															
#35 ~ #48				Reserved	For system use															

Symbols

- : latched (when written in through RS-485 communication)
- ×: non-latched
- R: Able to read data by FROM instruction or RS-485 communication
- W: Able to write data by TO instruction or RS-485 communication
- LSB (Least Significant Bit): For voltage input 1_{LSB} = 10V/8,000 = 1.25mV
For current input 1_{LSB} = 20mA/4,000 = 5µA

Explanations:

- CR#0: Model name. The user can read the model name from the program and see if the extension module exists.
- CR#1: The working mode of the two channels in the analog output module. There are 4 modes for each channel which can be set up separately. For example, if the user needs to set up CH1: mode 2 (b2 ~ b0 = 010) and CH2: mode 1 (b5 ~ b3 = 001), CR#1 has to be set as H000A and the higher bits (b12 ~ b15) have to be reserved. Default value = H'0000.

3. CR#2 ~ CR#5: The settings of average times of the signals at CH1 ~ CH4. Range: K1 ~ K20 (default = K10). Please note that the average time settings at CR#2 ~ CR#5 only need to be written in once.

4. CR#6 ~ CR#9: The average of the signals at CH1 ~ CH4 obtained from the settings in CR#2 ~ CR#5. For example, if the settings in CR#2 ~ CR#5 is 10, the content in CR#6 ~ CR#9 will be the average of the most recent 10 signals at CH1 ~ CH4.

CR#10, CR#11, CR#16, CR#17, CR#22, CR#23, CR#28 and CR#29 are reserved.

5. CR#12 ~ CR#15: The present value of input signals at CH1 ~ CH4.

6. CR#18 ~ CR#21: The adjusted OFFSET value of CH1 ~ CH4, representing the analog input voltage or current when the analog signal is converted into digital value 0.

The adjustable range of voltage: -5V ~ +5V (-4,000_{LSB} ~ +4,000_{LSB})
The adjustable range of current: -20mA ~ +20mA (-4,000_{LSB} ~ +4,000_{LSB})

7. CR#24 ~ CR#27: The adjusted GAIN value of CH1 ~ CH4, representing the analog input voltage or current when the analog signal is converted into digital value 4,000.

The adjustable range of voltage: -4V ~ +20V (-3,200_{LSB} ~ +16,000_{LSB})
The adjustable range of current: -16mA ~ +52mA (-3,200_{LSB} ~ +10,400_{LSB})

Please note that: GAIN value - OFFSET value = +800_{LSB} ~ +12,000_{LSB} (voltage) or +800_{LSB} ~ +6,400_{LSB} (current)
When GAIN - OFFSET is small (steep oblique), the resolution of input signal will be finer and variation on the digital value will be greater. When GAIN - OFFSET is big (gradual oblique), the resolution of input signal will be rougher and variation on the digital value will be smaller.

8. CR #30: Error status value (See the table below)

Error status	Content	b15 ~ b8	b7	b6	b5	b4	b3	b2	b1	b0
Abnormal power supply	K1(H'1)	reserved	0	0	0	0	0	0	0	1
Incorrect analog input value	K2(H'2)		0	0	0	0	0	0	1	0
Incorrect mode setting	K4(H'4)		0	0	0	0	0	1	0	0
OFFSET/GAIN error	K8(H'8)		0	0	0	0	1	0	0	0
Hardware malfunction	K16(H'10)		0	0	0	1	0	0	0	0
Abnormal digital range	K32(H'20)		0	0	1	0	0	0	0	0
Incorrect average times setting	K64(H'40)		0	1	0	0	0	0	0	0
Instruction error	K128(H'80)		1	0	0	0	0	0	0	0

Note: Each error status is determined by the corresponding bit (b0 ~ b7) and there may be more than 2 errors occurring at the same time. 0 = normal; 1 = error

9. CR#31: The setting of RS-485 communication address (Range: 01 ~ 255, default = K1).

10. CR#32: The setting of RS-485 communication speed. b0: 4,800bps; b1: 9,600bps (default); b2: 19,200bps; b3: 38,400bps; b4: 57,600bps; b5: 115,200bps; b6 ~ b13: reserved; b14: high/low bit exchange of CRC checksum (only valid in RTU mode); b15 = 0: ASCII mode; b15 = 1: RTU mode. ASCII data format: 7-bit, Even bit, 1 stop bit (7, E, 1); RTU data format: 8-bit, Even bit, 1 stop bit (8, E, 1).

11. CR#33: For authorizations on some internal functions, e.g. OFFSET/GAIN tuning. The latched function will store the output setting in the internal memory before the power is cut off.

12. CR#34: Firmware version of the model.

13. CR#35 ~ CR#48: Parameters for system use.

14. CR#0 ~ CR#34: The corresponding parameter addresses H'4032 ~ H'4022 are for users to read/write data by RS-485 communication. When using RS-485, the user has to separate the module with MPU first.

a. Communication baud rate: 4,800/9,600/19,200/38,400/57,600/115,200bps

b. Modbus ASCII/RTU communication protocols: ASCII data format (7-bit, Even bit, 1 stop bit (7, E, 1)); RTU data format (8-bit, Even bit, 1 stop bit (8, E, 1)).

c. Function: H'03 (read register data); H'06 (write 1 word datum to register); H'10 (write many word data to register)

d. Latched CR should be written by RS-485 communication to stay latched. CR will not be latched if written by MPU through TO/DTO instruction.

4 Adjusting A/D Conversion Curve

4.1 Explanation

Voltage Input Mode

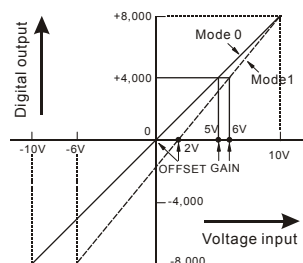

CR#1 mode 0	GAIN = 5V (4,000 _{LSB}) OFFSET = 0V (0 _{LSB})
CR#1 mode 1	GAIN = 6V (4,800 _{LSB}) OFFSET = 2V (1,600 _{LSB})
GAIN	The voltage input value when the digital output value = K4,000 Range: -4V ~ +20V (-3,200 _{LSB} ~ +16,000 _{LSB})
OFFSET	The voltage output value when the digital input value = K0 Range: -5V ~ +5V (-4,000 _{LSB} ~ +4,000 _{LSB})
GAIN - OFFSET	Range: +1V ~ +15V (+800 _{LSB} ~ +12,000 _{LSB})

Current Input Mode

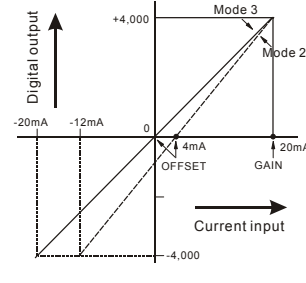

CR#1 mode 2	GAIN = 12mA (2,400 _{LSB}) OFFSET = 4mA (800 _{LSB})
CR#1 mode 3	GAIN = 10mA (2,000 _{LSB}) OFFSET = 0mA (0 _{LSB})
GAIN	The current input value when the digital output value = K2,000 Range: -8mA ~ +40mA (-1,600 _{LSB} ~ +8,000 _{LSB})
OFFSET	The current input value when the digital output value = K0 Range: -10mA ~ +10mA (-2,000 _{LSB} ~ +2,000 _{LSB})
GAIN - OFFSET	Range: +2mA ~ +30mA (+400 _{LSB} ~ +6,000 _{LSB})

The user can adjust the OFFSET/GAIN curves according to the actual needs by changing the OFFSET value (CR#18 ~ CR#21) and GAIN value (CR#24 ~ CR#27).

LSB refers to "least significant bit": In voltage input, 1_{LSB} = 10V/8000 = 1.25mV; in current input, 1_{LSB} = 20mA/4,000 = 5μA.

4.2 Program Example

Example 1: Set the OFFSET value of CH1 as 0V (= K0_{LSB}) and GAIN value as 2.5V (= K2,000_{LSB}).



- Write H'0 into CR#1 of analog input module No.0 and set CH1 in mode 0 (voltage input -10V ~ +10V).
- Write H'0 into CR#33 and allow OFFSET/GAIN tuning in CH1 ~ CH4
- When X0 goes from Off to On, write the OFFSET value K0_{LSB} into CR#18 and the GAIN value K2,000_{LSB} into CR#24.

Example 2: Set the OFFSET value of CH2 as 2mA (= K400_{LSB}) and GAIN value as 18mA (= K3,600_{LSB}).



- Write H'18 into CR#1 of analog input module No.0 and set CH2 in mode 3 (current input -20mA ~ +20mA).
- Write H'0 into CR#33 and allow OFFSET/GAIN tuning in CH1 ~ CH4
- When X0 goes from Off to On, write the OFFSET value K400_{LSB} into CR#19 and the GAIN value K3,600_{LSB} into CR#25.

5 Trial Operation & Troubleshooting

❖ LED Display

- When the module is powered for the first time, POWER LED will be on and ERROR LED will be on for 0.5 second. After this, A/D LED will start to flash.
- When the power supply is normal, POWER LED will be on and ERROR LED should be off. When the power supply is less than 19.5V, ERROR LED will keep being on until the power supply is higher than 19.5V.
- When controlled by RS-485, the RS-485 LED on the module will flash after receiving the RS-485 instruction.
- When the input or output value exceeds the upper bound or falls below the lower bound after conversion, ERROR LED will flash.

❖ Program Example

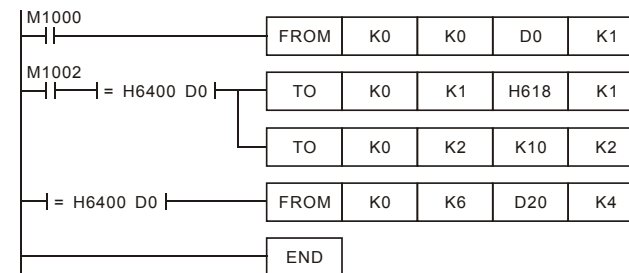

- Read the model name from K0 and see if it is DVP04AD-H2: H'6400.
- If D0 = H'6400, set the input modes: (CH1, CH3) mode 0, (CH2, CH4) mode 3.
- Set the average times in CH1 and CH2 as K10.
- Read the average of input signals at CH1 ~ CH4 from CR#6 ~ CR#9 and store the 4 data in D20 ~ D23.

6 Relevant Instructions

API		FROM		(m1)	(m2)	(D)	(n)	
78	D		P					Read CR data in special modules

Instruction Explanation	(m1): No. of special module (m1 = 0 ~ 7) (m2): CR# in special module to be read (D): Device for storing read data (n): Number of data to be read at a time
Program Example	Read CR#24 of special module No.0 into D0 and CR#25 into D1. Only 2 groups of data are read at a time (n = 2).

API		TO		(m1)	(m2)	(S)	(n)	
79	D		P					Write CR data into special modules

Instruction Explanation	(m1): No. of special module (m1 = 0 ~ 7) (m2): CR# in special module to be written (S): Data to be written into CR (n): Number of data to be written at a time
Program Example	Use 32-bit instruction DTO to write the content in D11 and D10 into CR#3 and CR#2 of special module No.0. Only 1 group of data is written in at a time (n = 1).

Operand rules

- (m1): The No. of special modules connected to PLC MPU. No. 0 is the module closest to the MPU. Maximum 8 modules are allowed to be connected to a PLC MPU and they will not occupy any I/O points.
- (m2): CR#. CR (control register) is the 49 16-bit memories built in the special module, numbered in decimal as #0 ~ #48. All operation status and settings of the special module are contained in the CR.
- FROM/TO instruction is for reading/writing 1 CR at a time. DFROM/DTO instruction is for reading/writing 2 CRs at a time.



- Number of groups "n" to be transmitted: n = 2 in 16-bit instructions and n = 1 in 32-bit instructions mean the same.

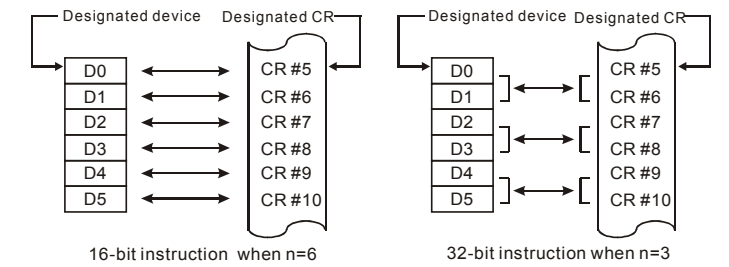

Remarks

M1083 for switching instruction modes in EH2 series models

- When M1083 = Off, during the execution of FROM/TO instruction, all external or internal interruption subroutines will be forbidden. The interruptions are allowed only after FROM/TO instruction finishes its execution. FROM/TO instruction can also be used in an interruption subroutine.
- When M1083 = On and an interruption signal occurs during the execution of FROM/TO instruction, the interruption will be processed first (with a 100μs delay) and the execution of FROM/TO will be stopped. After the interruption subroutine finishes its execution, the program will jump to the next instruction of FROM/TO. FROM/TO cannot be used in an interruption subroutine.