

Relay Terminal Block

Features

- For driving various loads using PLC output signals
- Easily check operation status and high luminance LED turns on with input signals
- Choose various relays depending on each load voltage or current
 - Easily replace relays using the relay removal lever (1-point relay terminal block)
- 2 mounting methods (DIN rail, screw mount)
- Tight installation and expansion possible with interlocking design (1-point relay terminal block)

※Autonics I/O cable CJ Series is recommended.
Please refer to page B-2.

! Please read "Safety Considerations" in operation manual before using.



Ordering Information

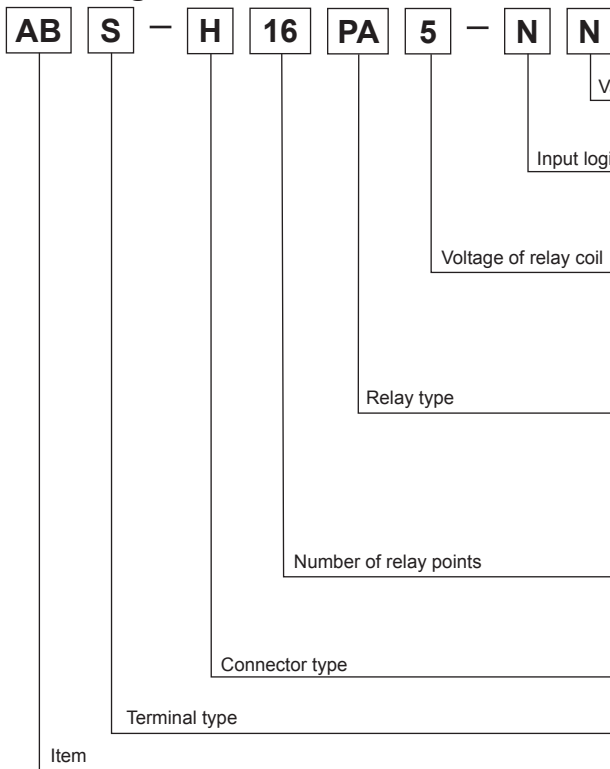

Varistor installation	N	Not installed
Input logic	C	COM None ^{※1}
	N	NPN (COM+)
	P	PNP (COM-)
Voltage of relay coil	No-mark	24VDC
	5	200/220VAC
	6	100/110VAC
Relay type	TN	TAKAMISAWA (Fujitsu) NYP
	PA	MATSUSHITA (Panasonic) PA
	PQ	MATSUSHITA (Panasonic) PQ
	R6	OMRON G6B
	PH	MATSUSHITA (Panasonic) AHN
	R2	OMRON G2R
Number of relay points	01	1
	04	4
	16	16
	32	32
Connector type	S	Screw
	H	Hirose connector
Terminal type	S	Screw
	AB	Relay terminal block

※1: It is only for 1-point and 4-point models.

※This ordering information is only for reference. When selecting the model, refer to the specifications of each model.

Crimp Terminal Specifications

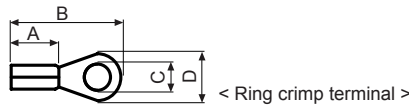
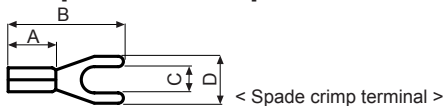

Rated load current 2/3A

(unit: mm)

	A	B	C	D	Applicable wire
Spade crimp terminal	≥4.1	≤16.0	≥3.0	≤5.9	AWG 22-16
Ring crimp terminal	≥4.1	≤16.0	≥3.0	≤5.9	(0.30 to 1.25mm ²)

Rated load current 5A, 10A

	A	B	C	D	Applicable wire	
					Rated load current 5A	Rated load current 10A
Spade crimp terminal	≥4.1	≤16.0	≥3.0	≤7.0	AWG 19-14	AWG 17-14
Ring crimp terminal	≥4.1	≤16.0	≥3.0	≤7.0	(0.65 to 2.0mm ²)	(1.0 to 2.0mm ²)

※Please use UL certified crimp terminals.

I/O Terminal Blocks

Interface Terminal Block

AFS (screw)

AFL (screwless)

AFR (rising clamp)

Common Terminal Block

ACS (screw)

Sensor Connector Terminal Block

AFE (sensor Connector)

Relay Terminal Block

ABS (screw)

ABL (screwless)

Power Relay (relay terminal block)

I/O Cables

mitsubishi

LSIS

Autonics

RS Automation

YOKOGAWA

FUJI

KDT

OMRON

TELEMECANIQUE

For SERVO

Open Type Cables

Cable Appearance

Remote I/O

ARD (DeviceNet Digital Standard Terminal Type)

ARD (DeviceNet Digital Sensor Connector Type)

ARD (DeviceNet Analog Standard Terminal Type)

ARM (Modbus Digital Sensor Connector Type)

Others

Sensor Connectors

Sockets

Sensor Distribution Boxes



Valve Plugs

Thumbwheel Switches

ABS Series

Specifications

Rated load current 2/3A

Model	ABS-S01PA-CN ABS-S01TN-CN	ABS-S04PA-CN ABS-S04TN-CN	ABS-H16PA-NN(PN) ABS-H16TN-NN(PN)	ABS-H32PA-NN(PN) ABS-H32TN-NN(PN)	
Power supply	24VDC \pm 10%				
Rated load voltage & current ^{*1}	250VAC \sim 3A, 30VDC \equiv 3A			250VAC \sim 2A, 30VDC \equiv 2A (2A/1-point, 8A/1COM)	
Current consumption	PA type	\leq 10.5mA ^{*2}	\leq 10.5mA ^{*2} / \leq 15.5mA ^{*3}		
	TN type	\leq 8.5mA ^{*2}	\leq 8.5mA ^{*2} / \leq 13.5mA ^{*3}		
Output type	1a contact relay output				
Applicable relay	PA: PA1a-24V [MATSUSHITA (Panasonic)], TN: NYP24W-K [TAKAMISAWA (Fujitsu)]				
No. of relay points	1-point	4-point	16-point	32-point (8-point/1COM)	
No. of connector pins	—		20-pin	40-pin	
Indicator	Operation indicator: Blue LED		Power indicator: Red LED, Operation and disconnection indicator: Blue LED		
Applicable wire	AWG22-16 (0.30 to 1.25mm ²)				
Insulation resistance	\geq 1,000M Ω (at 500VDC megger)				
Dielectric strength	Between coil-contact	2,000VAC 50/60Hz for 1 minute			
	Between same contacts	1,000VAC 50/60Hz for 1 minute ^{*4}			
Vibration	Mechanical	0.75mm amplitude at frequency of 10 to 55 Hz (for 1 min) in each X, Y, Z direction for 2 hours			
	Malfunction	0.75mm amplitude at frequency of 10 to 55 Hz (for 1 min) in each X, Y, Z direction for 10 minute			
Shock	Mechanical	500m/s ² (approx. 50G) in each X, Y, Z direction for 3 times			
	Malfunction	147m/s ² (approx. 15G) in each X, Y, Z direction for 3 times			
Environment	Ambient temperature	-15 to 55°C, storage: -25 to 65°C			
	Ambient humidity	35 to 85%RH, storage: 35 to 85%RH			
Material	CASE & BASE: Polyamide 6, TERMINAL PIN: Brass	CASE & BASE: Modified Polyphenylene Oxide, TERMINAL PIN: Brass	CASE: MPPO, BASE: Polyamide 66 (G25%) TERMINAL PIN: Brass		
Tightening torque	5.1 to 6.1kgf·cm (0.5 to 0.6 N·m)				
Accessories ^{*5}	—	Jumper bar: 2 (Model: JB-7.62-04)	Jumper bar: 2 (Model: JB-7.62-08)	—	
Approval					
Weight ^{*7}	PA type	Approx. 314.5g (approx. 21.5g) ^{*8}	Approx. 104g (approx. 68g)	Approx. 307g (approx. 224g)	Approx. 438g (approx. 345g)
	TN type	Approx. 324.5g (approx. 22.2g) ^{*8}	Approx. 107g (approx. 71g)	Approx. 318g (approx. 235g)	Approx. 463g (approx. 370g)

Rated load current 5A, 10A

Model	ABS-S01PQ-CN ABS-S01R6-CN	ABS-S01PH-CN	ABS-S01PH6-CN	ABS-S01PH5-CN	ABS-S01R2-CN	ABS-S01R26-CN	ABS-S01R25-CN
Power supply	24VDC \pm 10%	24VDC \equiv	100/110VAC \sim	200/220VAC \sim	24VDC \equiv	100/110VAC \sim	200/220VAC \sim
Rated load voltage & current ^{*1}	250VAC \sim 5A, 30VDC \equiv 5A	250VAC \sim 10A, 30VDC \equiv 10A ^{*1}					
Current consumption ^{*2}	PQ/R6 type	\leq 20mA	—				
	PH/R2 type	—	\leq 25mA	\leq 15mA	\leq 10mA	\leq 25mA	\leq 15mA
Output type	1a contact relay output	1c contact relay output					
Applicable relay	PQ: PQ1a-24V [MATSUSHITA (Panasonic)] R6: G6B-1174P-FD-US [OMRON]	AHN12024 [MATSUSHITA (Panasonic)]	AHN111X0 [MATSUSHITA (Panasonic)]	AHN111Y0 [MATSUSHITA (Panasonic)]	G2R-1-S24VDC [OMRON]	G2R-1-S100/ (110) VAC [OMRON]	G2R-1-S200/ (220) VAC [OMRON]
No. of relay points	1-point	—					
Applicable wire	AWG 19 to 14 (0.65 to 2.0mm ²)	AWG 17 to 14 (1.0 to 2.0mm ²)					
Insulation resistance	\geq 1,000M Ω (at 500VDC megger)						
Dielectric strength	Between coil-contact	4,000 VAC 50/60Hz for 1 minute ^{*4}	5,000VAC 50/60Hz for 1 minute				
	Between same contacts	1,000VAC 50/60Hz for 1 minute ^{*4}	1,000VAC 50/60Hz for 1 minute				
Vibration	Mechanical	0.75mm amplitude at frequency of 10 to 55 Hz (for 1 min.) in each X, Y, Z direction for 2 hours	1.5mm amplitude at frequency of 10 to 55 Hz (for 1 min) in each X, Y, Z direction for 2 hours				
	Malfunction	0.75mm amplitude at frequency of 10 to 55 Hz (for 1 min.) in each X, Y, Z direction for 10 minute	1.5mm amplitude at frequency of 10 to 55 Hz (for 1 min) in each X, Y, Z direction for 10 minute				
Shock	Mechanical	1,000m/s ² (approx. 100G) in each X, Y, Z direction for 3 times					
	Malfunction	100m/s ² (approx. 10G) in each X, Y, Z direction for 3 times					
Environment	Ambient temperature	-15 to 55°C, storage: -25 to 65°C					
	Ambient humidity	35 to 85%RH, storage: 35 to 85%RH					
Material	CASE & BASE: PA6, TERMINAL PIN: Brass	CASE, BASE: PBT, TERMINAL PIN: Brass, Phosphor bronze					
Tightening torque	7.14 to 8.16kgf·cm (0.7 to 0.8N·m)						
Approval							
Weight ^{*8}	PQ: Approx. 430g (approx. 31g), R6: Approx. 416g (approx. 30g)	Approx. 720g (approx. 53g)	Approx. 711g (approx. 52g)	Approx. 715g (approx. 52g)	Approx. 719g (approx. 53g)	Approx. 711g (approx. 52g)	Approx. 712g (approx. 52g)

*1: Relay contact capacity for resistive load.

*2: The current consumption including LED current by one relay.

*3: The current consumption including power LED at *1.

*4: R6 type (OMRON relay) is 3,000VAC.

TN type (Fujitsu relay) is 750VAC.

*5: ABS-H32□□-NN(PN) does not supply jumper bars.

*6: Except 30VDC of rated load voltage for .

*7: The weight includes packaging. The weight in parenthesis is for unit only.

*8: The weight of 1-point relays is per 10 units with packing and the weight of parenthesis is per 1.

*Environment resistance is rated at no freezing or condensation.

Relay Terminal Block

Dimensions

Rated load current 2/3A

ABS-S01PA-CN / ABS-S01TN-CN

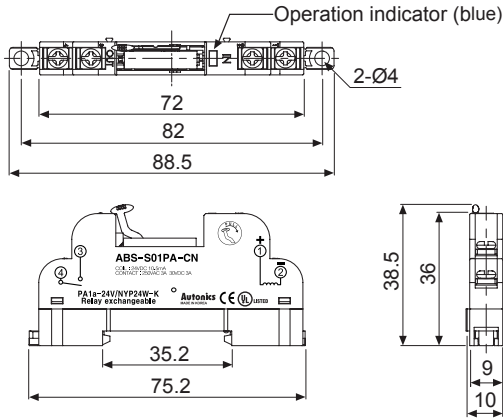

ABS-S04PA-CN / ABS-S04TN-CN

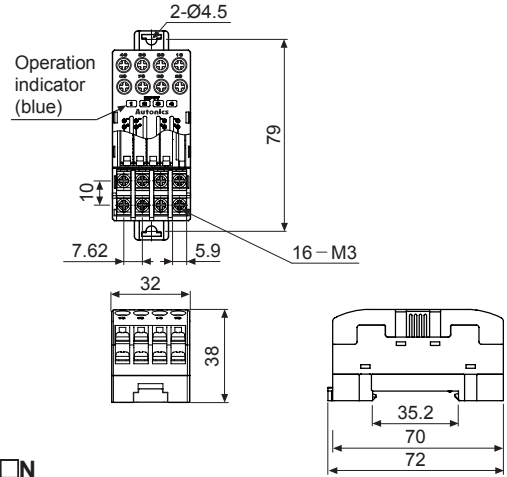

ABS-H16PA-□N / ABS-H16TN-□N ●ABS-H32PA-□N / ABS-H32TN-□N

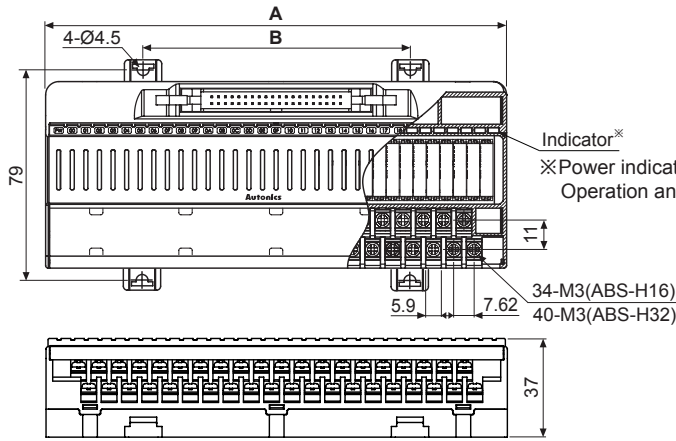

	ABS-H16	ABS-H32
A	140	173
B	70	100

Indicator*
 *Power indicator: Red LED,
 Operation and disconnection indicator: Blue LED

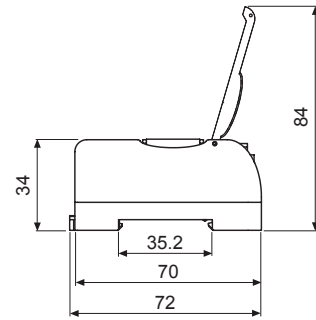

Jumper bar (sold separately)

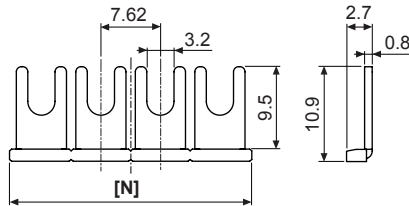

Model	JB-7.62-04	JB-7.62-08
No. of jumper bar pins	4	8
[N] size	29.5	60.0

Rated load current 5A, 10A

ABS-S01PQ-CN / ABS-S01R6-CN

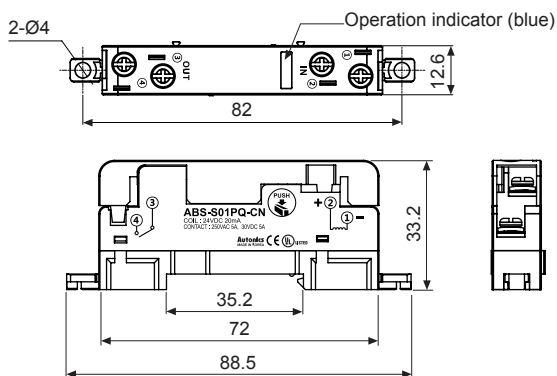

ABS-S01PH-□CN / ABS-S01R2-□CN

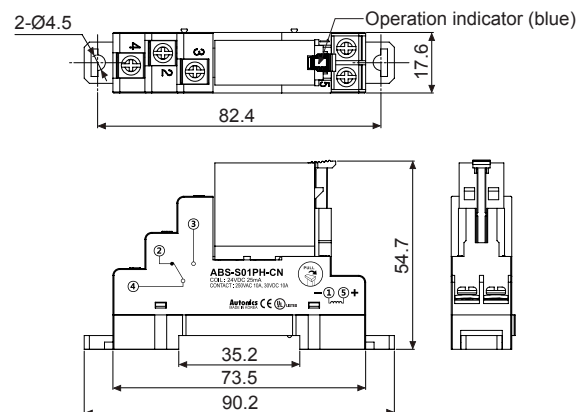

I/O Terminal Blocks

Interface Terminal Block

- AFS (screw)
- AFL (screwless)
- AFR (rising clamp)

Common Terminal Block

- ACS (screw)

Sensor Connector Terminal Block

- AFE (sensor Connector)

Relay Terminal Block

- ABS (screw)
- ABL (screwless)
- Power Relay (relay terminal block)

I/O Cables

- MITSUBISHI
- LSIS
- Autonics
- RS Automation
- YOKOGAWA
- FUJI
- KDT
- OMRON
- TELEMECANIQUE
- For SERVO
- Open Type Cables
- Cable Appearance

Remote I/O

- ARD (DeviceNet Digital Standard Terminal Type)
- ARD (DeviceNet Digital Sensor Connector Type)
- ARD (DeviceNet Analog Standard Terminal Type)
- ARM (Modbus Digital Sensor Connector Type)

Others

- Sensor Connectors
- Sockets
- Sensor Distribution Boxes
- Valve Plugs
- Thumbwheel Switches

ABS Series

Connections

Rated load current 2/3A

• ABS-S01PA-CN / ABS-S01TN-CN

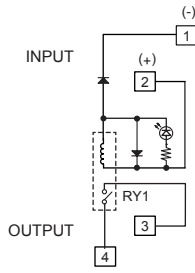

• ABS-S04PA-CN / ABS-S04TN-CN

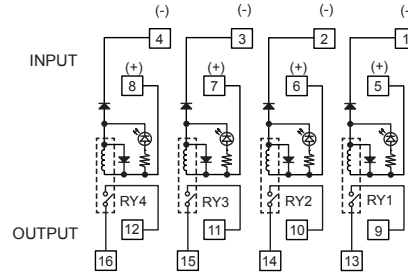

• ABS-H16□-NN

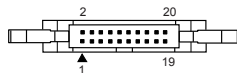

※Hirose connector socket : HIF3BA-20PA-2.54DSA

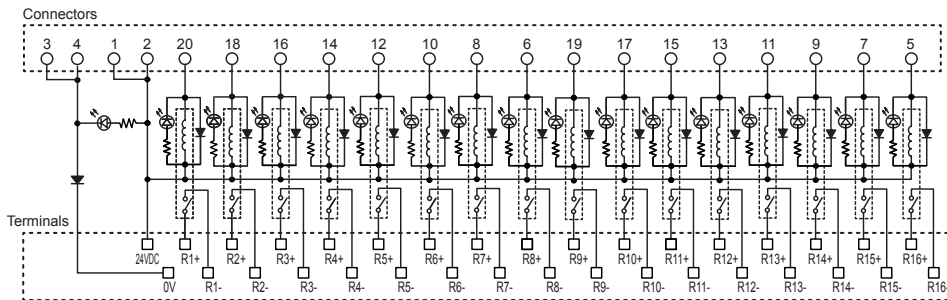

• ABS-H16□-PN

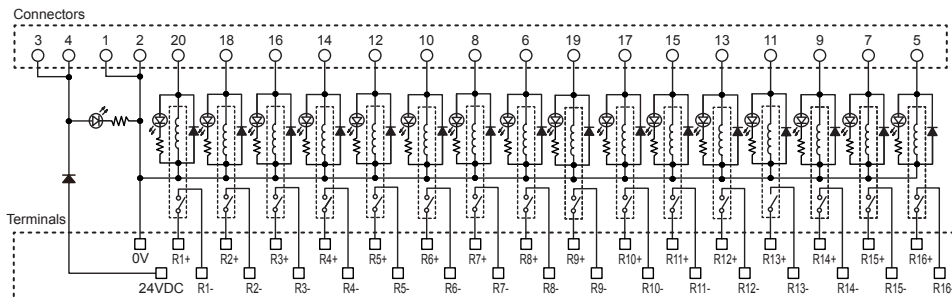

• ABS-H32□-NN

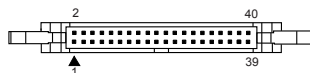

※Hirose connector socket : HIF3BA-40PA-2.54DSA

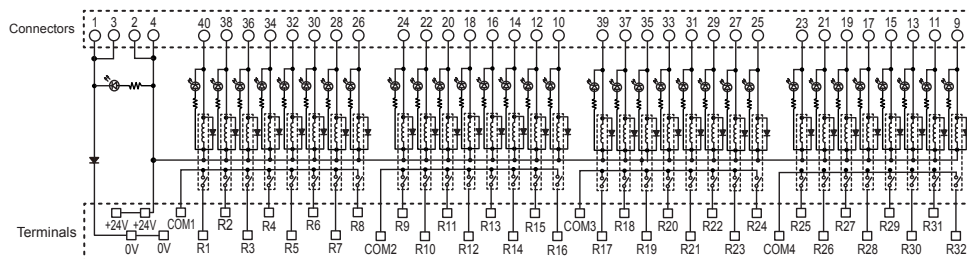

• ABS-H32□-PN

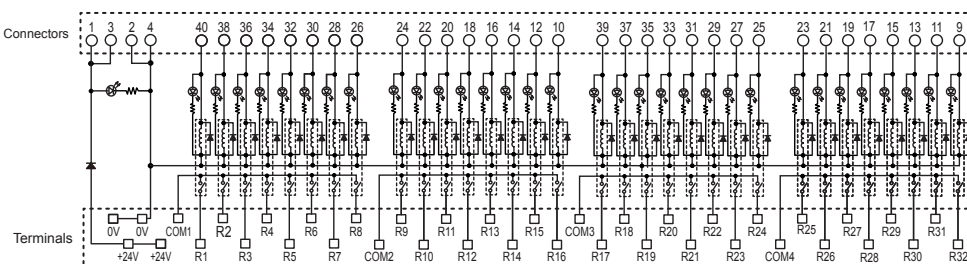

Connections

Rated load current 5A, 10A

• ABS-S01PQ-CN
ABS-S01R6-CN

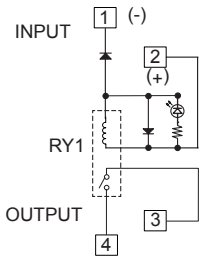

• ABS-S01PH-CN
ABS-S01R2-CN

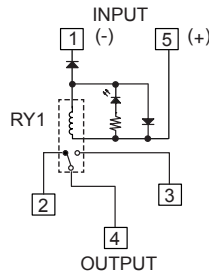

• ABS-S01PH6-CN
ABS-S01PH5-CN
ABS-S01R26-CN
ABS-S01R25-CN

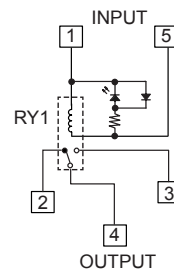

Replacing Relays

Rated load current 2/3A

• ABS-S01PA-CN / ABS-S01TN-CN

- 1) Pull the relay removal lever towards direction ① and the relay will pop up in direction ②.
- 2) Remove the relay and return the relay removal lever to its original position.
- 3) Check the socket position and insert the relay into the socket.

※If pulling the relay removal lever to left or right, the lever may be broken.

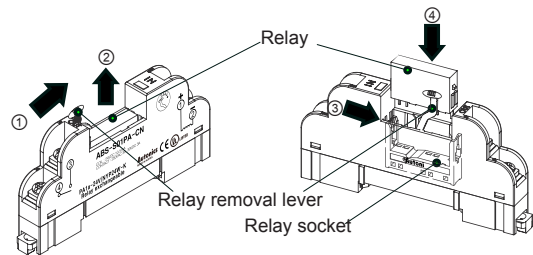

• ABS-S04PA-CN / ABS-S04TN-CN
• ABS-H16PA-□N / ABS-H16TN-□N
• ABS-H32PA-□N / ABS-H32TN-□N

• Two way ejector position for relay replacement

< Two way ejector >

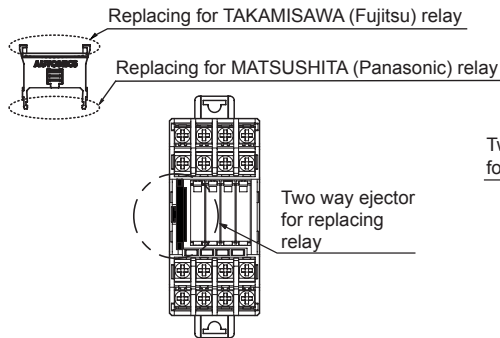

< ABS-S04 >

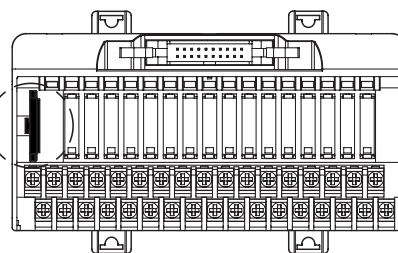

< ABS-H16 / ABS-H32 >

• Removal and insert TAKAMISAWA (Fujitsu) relay

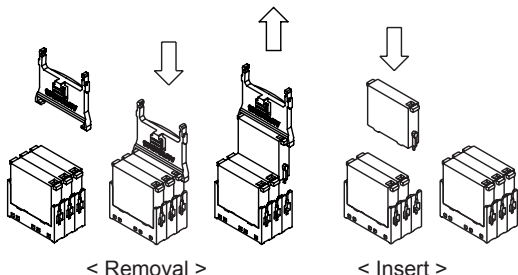

< Removal >

< Insert >

• Removal and insert MATSUSHITA (Panasonic) relay

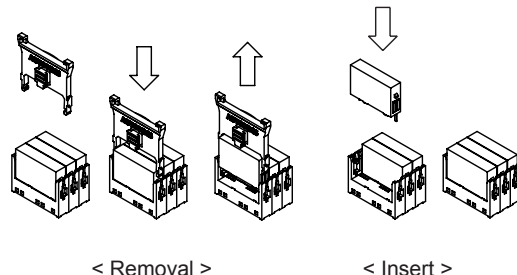

< Removal >

< Insert >

※Relay sockets are compatible with both TAKAMISAWA (Fujitsu) relay, NYP24W-K, and MATSUSHITA (Panasonic) relay, PA1a-24V.

I/O Terminal Blocks

Interface Terminal Block

AFS (screw)

AFL (screwless)

AFR (rising clamp)

Common Terminal Block

ACS (screw)

Sensor Connector Terminal Block

AFE (sensor Connector)

Relay Terminal Block

ABS (screw)

ABL (screwless)

Power Relay (relay terminal block)

I/O Cables

MITSUBISHI

LSIS

Autonics

RS Automation

YOKOGAWA

FUJI

KDT

OMRON

TELEMECANIQUE

For SERVO

Open Type Cables

Cable Appearance

Remote I/O

ARD (DeviceNet Digital Standard Terminal Type)

ARD (DeviceNet Digital Sensor Connector Type)

ARD (DeviceNet Analog Standard Terminal Type)

ARM (Modbus Digital Sensor Connector Type)

Others

Sensor Connectors

Sockets

Sensor Distribution Boxes

Valve Plugs

Thumbwheel Switches

ABS Series

■ Replacing Relays

◎ Rated load current 5A

● ABS-S01PQ-CN / ABS-S01R6-CN

- 1) Pull the protection cover towards direction ①.
- 2) Press the operation indicator guide in direction ② and remove the relay towards direction ③.
- 3) Insert a new relay into position.

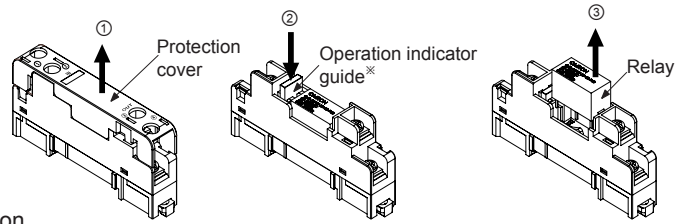

※Operation indicator guide is used for displaying operation status and removing relays

◎ Rated load current 10A

● ABS-S01PH□-CN / ABS-S01R2□-CN

- 1) Pull the relay removal lever towards direction ①. Remove the relay towards direction ②.
- 2) Insert a new relay into position.

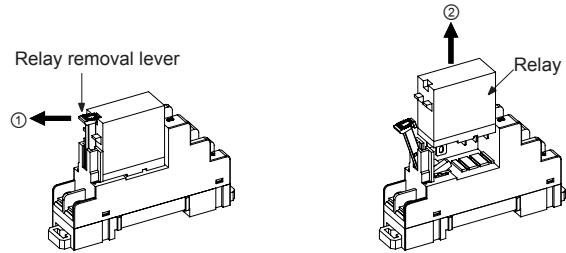

■ Installation

※Each model appearance is different by no. of relay points.

◎ Mounting and Removal at DIN rail

● Mounting

- 1) Pull the rail lock towards direction ①.
- 2) Attach the DIN rail connection hook onto the DIN rail.
- 3) Push the unit towards direction ②, then push the rail lock in to lock into position.

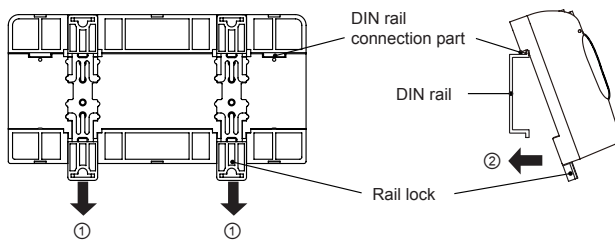

● Removal

- 1) Insert a screwdriver into the rail lock hole and pull it towards direction ①.
- 2) Remove the unit by pulling the unit towards direction ②.

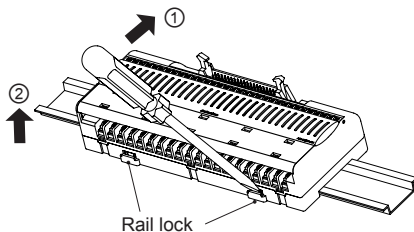

◎ Mounting with screws

- 1) The unit can be mounted on panels using the rear rail locks.
- 2) Pull the rail locks towards directions ① and ②.
- 3) M4 x 15mm spring washer screws are recommended for installation. When using flat washers, use Ø6mm diameter washers. The tightening torque should be between 7.14 and 10.2kgf·cm (0.7 to 1.0N·m).

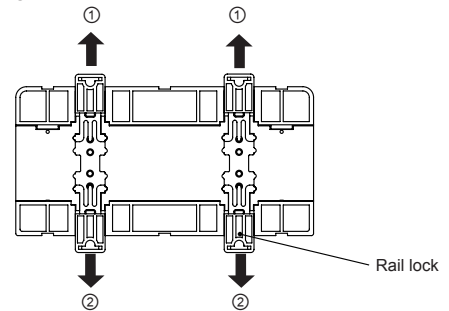

◎ Connecting multiple units (1-point relay terminal block)

Connect multiple units by locking the socket (凹) and peg (凸) together in direction ①.

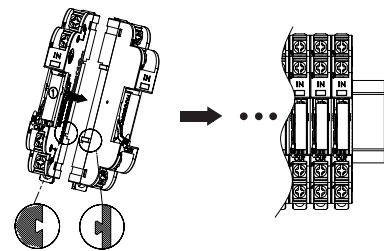

※E.g.

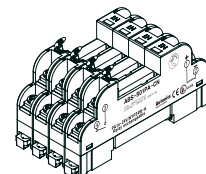

■ Installing Jumper Bars (4, 16, 32-point relay terminal block)

1) Cut the jumper bar to the user's desired length by cutting at the V dent using a nipper.

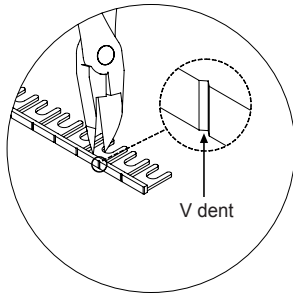

2) Unfasten all the screws of the terminals you wish to commonize.

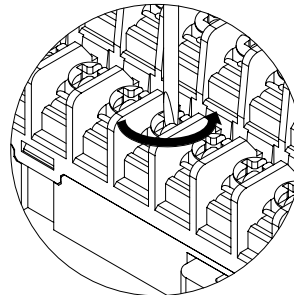

3) Insert the jumper bar below the unfastened screws.

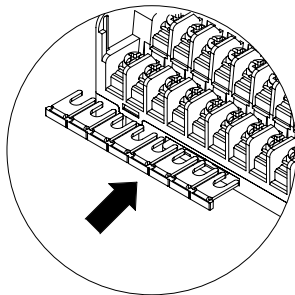

4) Tighten all the screws above the jumper bar.

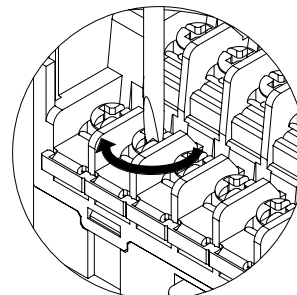

■ Cautions during Use

1. Use the unit within the rated environment of specification.
2. Supply power within the rated allowable voltage range.
3. Check the polarity of power or COMMON before connecting PLC or other controllers.
4. Please use power wires listed in the specifications. For using crimp terminals, refer to '■ Crimp Terminal Specifications'.
2, 3A: AWG22-16 (0.30 to 1.25mm²), 5A: AWG19-14 (0.65 to 2.0mm²), 10A: AWG17-14 (1.0 to 2.0mm²)
5. Do not connect wire, remove connector, or replace relays while connected to a power source.
6. Do not touch the unit immediately after the load power is supplied or cut. It may cause burn by high temperature.
7. Do not use the unit when screws are released. It may cause malfunction or burnout.
8. Do not apply the excessive force to the removal lever (3A, 10A) or operation indicator guide (5A) when removing a relay.
9. In case of 24VDC signal input, isolated and limited voltage/current or Class 2 source should be provided for power supply.
10. Do not use the unit at below places.
 - ① Environments with high vibration or shock.
 - ② Environments where strong alkalis or acids are used.
 - ③ Environments with exposure to direct sunlight.
 - ④ Near machinery which produce strong magnetic force or electric noise
11. This unit may be used in the following environments.
 - ① Indoors
 - ② Altitude max. 2,000m
 - ③ Pollution degree 2
 - ④ Installation category II

I/O Terminal Blocks

Interface Terminal Block

AFS (screw)
AFL (screwless)
AFR (rising clamp)

Common Terminal Block

ACS (screw)

Sensor Connector Terminal Block

AFE (sensor Connector)

Relay Terminal Block

ABS (screw)

ABL (screwless)
Power Relay (relay terminal block)

I/O Cables

mitsubishi

LSIS

Autonics

RS Automation

YOKOGAWA

FUJI

KDT

OMRON

TELEMECANIQUE

For SERVO

Open Type Cables

Cable Appearance

Remote I/O

ARD (DeviceNet Digital Standard Terminal Type)

ARD (DeviceNet Digital Sensor Connector Type)

ARD (DeviceNet Analog Standard Terminal Type)

ARM (Modbus Digital Sensor Connector Type)

Others

Sensor Connectors

Sockets

Sensor Distribution Boxes

Valve Plugs

Thumbwheel Switches