



Type	Appearance	Model	Contact block	LED block
			C contact	DC voltage
Flat rectangular (half guard), extended	 L16RRT-HB□ 	L16RRT-H□5	—	1 (5VDC)
		L16RRT-H□12		1 (12VDC)
		L16RRT-H□24		1 (24VDC)
※□ indicates color: R , B , G , Y , W ※The light unit and LED blocks are sold separately. (light unit: bold letters, LED block: regular letters) ※The LED color is the same as the control unit.				
• Dimensions (unit: mm)				
				
※For panel cut-out dimensions, please refer to page A-48.				

Control Switches

Ø16

Ø22/25

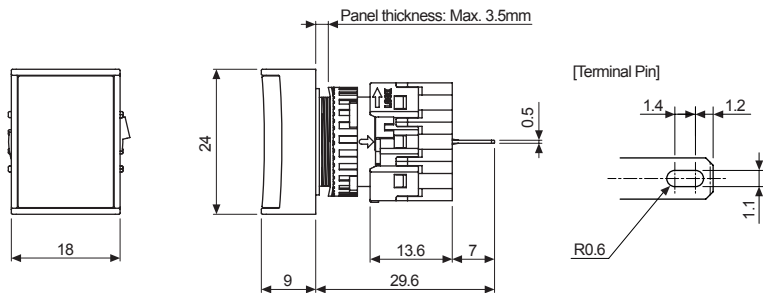
Ø30

□30

Push Button Switches

Round

Square

Rectangular

Selector Switches

Round

Square

Rectangular

Key Selector Switches

Round

Square

Rectangular

Double Push Button Switches

Mushroom-head Push Button Switches

Emergency Switches

Pilot Lights











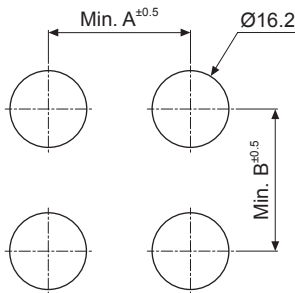



Accessories

Buzzers

Ø16 Panel Cut-out Dimensions

Ø16 Panel Cut-out Dimensions

(unit: mm)

Type			A	B	Panel Cut-out Dimensions
Push Button Switches	Round (S16PR Series)		20	21	
	Square (S16PRS Series)		20	21	
	Rectangular (S16PRT Series)		25	21	
Selector Switches	Round (S16SR Series)		20	21	
	Square (S16SRS Series)		20	21	
	Rectangular (S16SRT Series)		25	21	
Key Selector Switches	Round (S16KR Series)		20	21	
	Square (S16KRS Series)		20	21	
	Rectangular (S16KRT Series)		25	21	
Mushroom-head Push Button Switches (S16BR Series)			24	24	
Emergency Switches (S16ER Series)			40	40	
Pilot Lights	Round (L16RR Series)		20	21	
	Square (L16RRS Series)		20	21	
	Rectangular (L16RRT Series)		25	21	

Ordering Information

Pilot Lights

⊙ Mounting hole Ø16 Pilot Lights

L16RR — E R

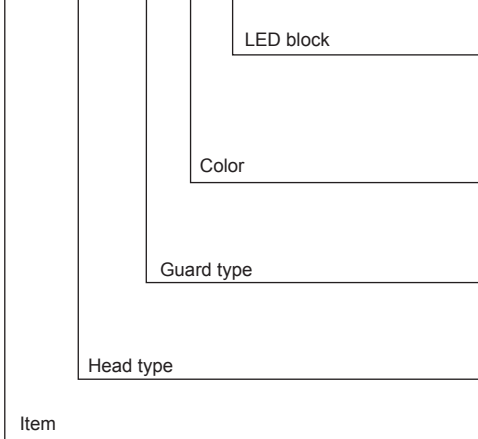

No-mark	None
5	5VDC
12	12VDC
24	24VDC
R	Red
B	Blue
G	Green
Y	Yellow
W	White
Round	E Extended
Square, Rectangular	H Half guard
No-mark	Round
S	Square
T	Rectangular
L16RR	Mounting hole Ø16 Pilot Lights

A Accessories

Common Accessories

Contact Blocks and LED Blocks for Ø16 Control Switches

Ordering Information



SA	16	CB	W	
Item				LED color ^{※1}
				Type
				Applied switches
				LED block
				CB ^{※2}
				Contact block
				L5
				L12
				L24
				16
				SA
				R Red
				B Blue
				G Green
				Y Yellow
				W White
				B contact (normally closed)
				C contact (normally open, normally closed)
				5VDC
				12VDC
				24VDC
				For Ø16 control switches
				Switch Accessories

※1. Only for LED blocks.

※2. Only for Ø16 emergency switches.

- **Contact block and LED block removal**
Separate the unit using a flat-head (-) screwdriver.





Item	Appearance	Model	Type	Features
Contact block		SA16-CB	B contact (normally closed)	For Ø16 emergency switches
		SA16-CC	C contact (normally open, normally closed)	—
LED block		SA16-L5□ (5VDC) SA16-L12□ (12VDC) SA16-L24□ (24VDC)	DC voltage type	Diverse, vibrant, high luminance LEDs (red, blue, green, yellow, white)

A Accessories

Locking Handle for Switches

Applied switches	Appearance	Model	Note
Ø16		SA16-LH	For locking switch nuts behind the panels

Accessories By Item

Item	Appearance	Model	Dimensions	Note
Lens remover for Ø16 push button control switches or pilot lights		SA16-RM		Lens remover for push button control switches or pilot lights