

>>> RKE Miniature General Purpose Relay

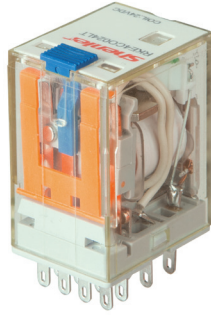

RKE2CO



RKE4CO

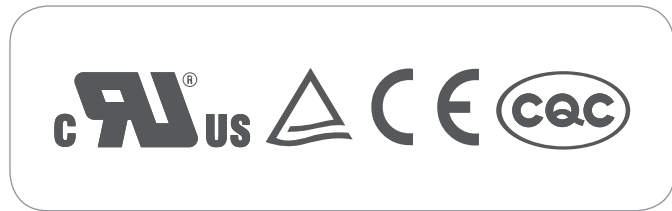

Features

- > 2 pole 7A; 4 pole 5A
- > With non-polarity LED integrated in relay
- > With lockable test button and inspection window
- > Identification of coils through test button color (AC red/DC blue)
- > Conformity with RoHS Directive

Ordering Information

RKE

Contact form _____
 2C: 2CO
 4C: 4CO

Mount options _____
 O: plug in

Coil voltage code _____

Code	006	012	024	036	048	110	220		
Voltage (V DC)	6	12	24	36	48	110	220		
Code	506	512	524	536	548	615	730	740	880
Voltage (V AC)	6	12	24	36	48	115	230	240	380

Options _____

LT: LED + test button
 LTD: LED + test button + diode (13-,14+)
 LTD1: LED + Test button + diode (13+,14-)
 A: for signal control (selection plus A, namely LTA, LTDA, LSA)

Characteristics

		2C	4C	
Contact	Configuration	2C	4C	
	Rated current/ Rated voltage	Resistive load	7A/250VAC 30VDC	5A/250VAC 30VDC
		Motor load	1/6HP 240VAC	
	Switching capacity (resistive)	1750VA, 210W	1250VA 150W	
	Initial contact resistance	≤50mΩ		
	Material	Ag alloy		
	Electric durability (110%rated voltage, 55°C)	≥20 x 10 ⁴ (1800 Ops/h)		
	Electric durability (Normal temperature)	≥40 x 10 ⁴ (360 Ops/h)		
Mechanical durability	≥2000 x 10 ⁴ (18000 Ops/h)			
Pick-up voltage (23°C)	DC:≤75% (Rated voltage), AC:≤80% 50/60Hz (Rated voltage)			
Drop-out voltage (23°C)	DC:≥10% (Rated voltage), AC:≥30% 50/60Hz (Rated voltage)			
Maximum voltage (23°C)	110% (Rated voltage)			
Insulation resistance	≥500MΩ (500VDC)			
Coil operating power	DC(W)	approx. 0.9		
	AC(VA)	approx. 1.2		
Operate time (at nominal voltage)	≤20 ms			
Release time (at nominal voltage)	≤20 ms			
Initial breakdown voltage	Between open contacts	1000VAC/1min (leakage current 1mA)		
	Between poles	2000VAC/1min (leakage current 1mA)		
	Between contacts and coil	2000VAC/1min (leakage current 1mA)		
Ambient temperature	-55~+70°C			
Humidity	35%~85%RH			
Air pressure	86~106KPa			
Shock resistance	10G (half-sine shock pulse: 11ms)			
Vibration resistance	10~55Hz double-amplitude:1.0mm			
Mounting	plug in			
Unit weight	35g			

Coil Specifications (23°C)

Nominal voltage V.DC	6	12	24	36	48	110	220		
Coil resistance Ω	40	180	640	1500	2600	13000	42000		
Nominal voltage V.AC	6	12	24	36	48	115	230	240	380
Coil resistance Ω	11.5	40	180	370	640	4430	16500	18790	42000

Remark: Coil resistance under coil voltage 110V are measured with tolerance of ±10%Ω, above coil voltage 110V are measured with tolerance of ±15%Ω.

Contact Specification

RKE2CO

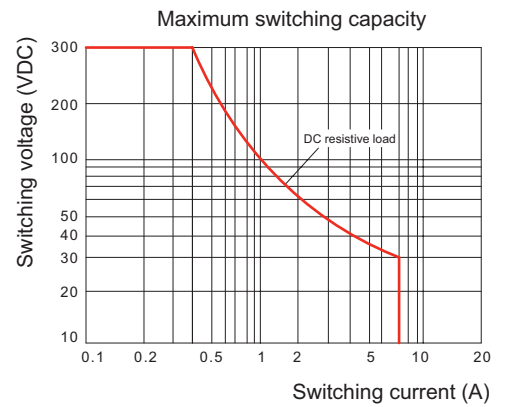
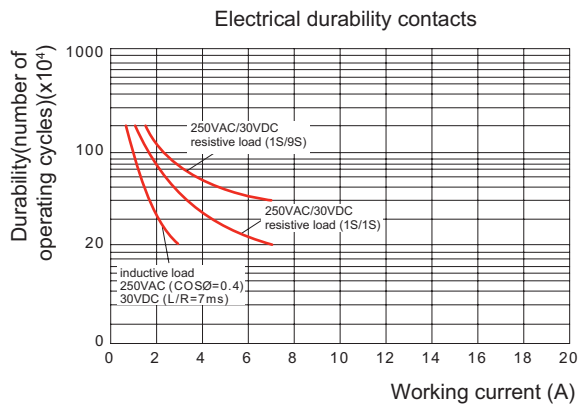

RKE4CO

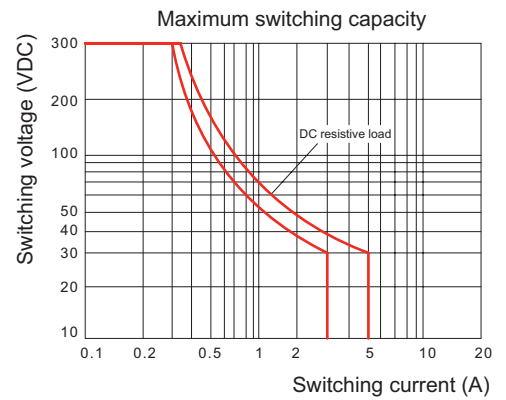
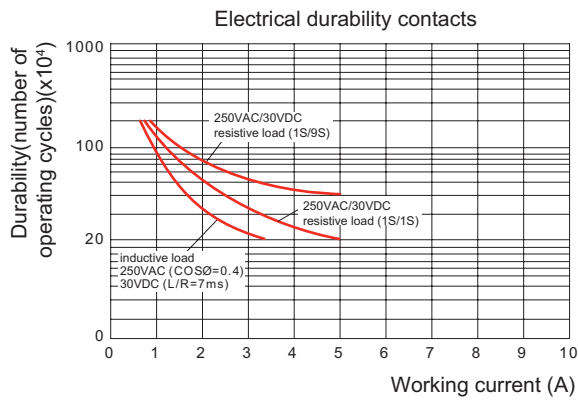

>>> RKE Miniature General Purpose Relay

Dimensions (mm)

RKE2CO

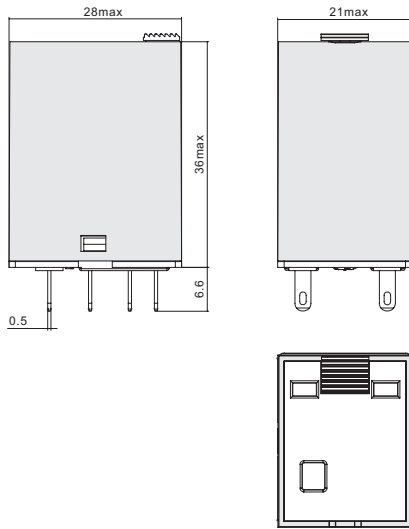

RKE4CO

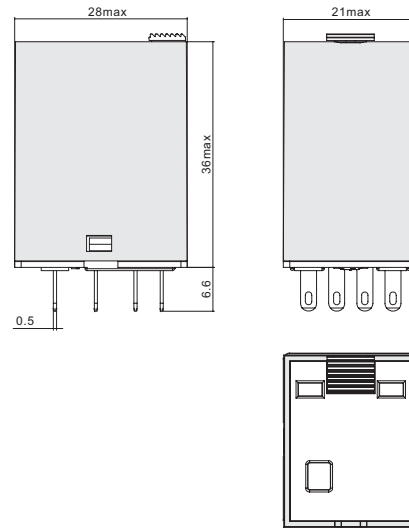

Wiring Diagrams

RKE2CO

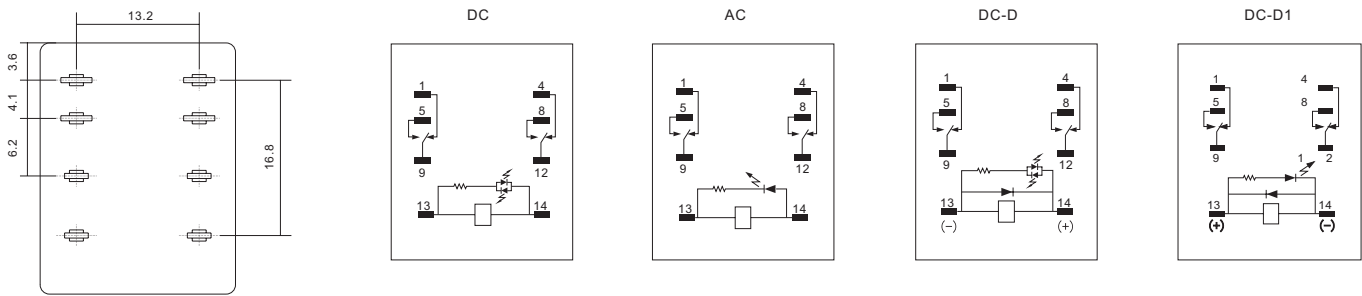

RKE4CO

