

2014-10-09



5011669906-T406

DVP04TC-S

Instruction Sheet
Bilgi Dökümanı

安 裝 說 明
安 装 说 明

Temperature Measurement Module

Sıcaklık Ölçüm Modülü

溫度量測模組

溫度量測模块



Thank you for choosing Delta DVP series PLC. DVP04TC-S is able to receive 4 points of external thermocouple temperature sensors and convert them into 14-point digital signals. Besides, through FROM/TO instructions in DVP Slim series MPU program, the data in the module can be read and written. There are many 16-bit control registers (CR) in DVP04TC-S. The power unit is separate from it and is small in size and easy to install.

- EN ✗ DVP04TC-S is an OPEN-TYPE device. It should be installed in a control cabinet free of airborne dust, humidity, electric shock and vibration. To prevent non-maintenance staff from operating DVP04TC-S, or to prevent an accident from damaging DVP04TC-S, the control cabinet in which DVP04TC-S is installed should be equipped with a safeguard. For example, the control cabinet in which DVP04TC-S is installed can be unlocked with a special tool or key.
- EN ✗ DO NOT connect AC power to any of I/O terminals, otherwise serious damage may occur. Please check all wiring again before DVP04TC-S is powered up. After DVP04TC-S is disconnected, Do NOT touch any terminals in a minute. Make sure that the ground terminal ⊕ on DVP04TC-S is correctly grounded in order to prevent electromagnetic interference.
- FR ✗ DVP04TC-S est un module OUVERT. Il doit être installé que dans une enceinte protectrice (boîtier, armoire, etc.) saine, dépourvue de poussière, d'humidité, de vibrations et hors d'atteinte des chocs électriques. La protection doit éviter que les personnes non habilitées à la maintenance puissent accéder à l'appareil (par exemple, une clé ou un outil doivent être nécessaire pour ouvrir a protection).
- FR ✗ Ne pas appliquer la tension secteur sur les bornes d'entrées/Sorties, ou l'appareil DVP04TC-S pourra être endommagé. Merci de vérifier encore une fois le câblage avant la mise sous tension du DVP04TC-S. Lors de la déconnection de l'appareil, ne pas toucher les connecteurs dans la minute suivante. Vérifier que la terre est bien reliée au connecteur de terre ⊕ afin d'éviter toute interférence électromagnétique.

■ Product Profile & Dimension

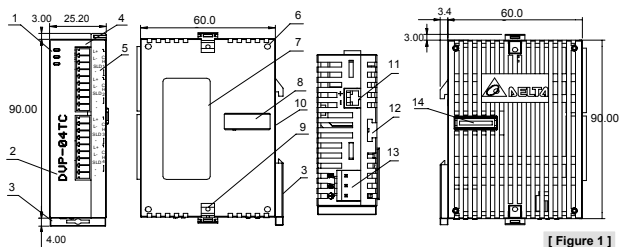

Unit: mm

1. Status indicator (POWER, RUN and ERROR)	2. Model name
3. DIN rail clip	4. I/O terminals
5. I/O point indicator	6. Mounting holes
7. Specification label	8. I/O module connection port
9. I/O module clip	10. DIN rail (35mm)
11. RS-485 communication port	12. I/O module clip
13. DC power input	14. I/O module connection port

■ I/O Terminal Layout



External Wiring

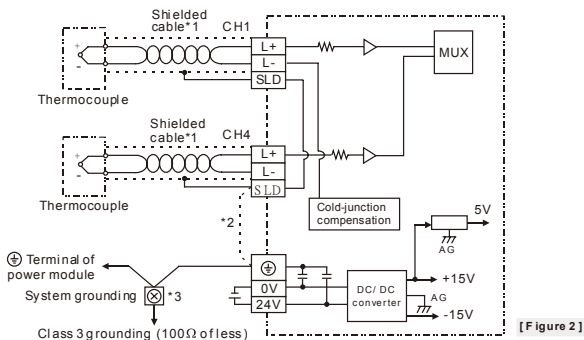

Note1: Use only the wires that are supplied with your thermocouple sensor. Tighten PLC terminal screws to a torque of 1.95 kg-cm (1.7 in-lbs).

Note2: Terminal SLD is a grounding location for noise suppression.

Note3: Please connect ⊕ power supply module terminal and ⊗ DVP04TC-S temperature measurement module terminal to system earth ground.

Warning: DO NOT connect wires to the No Connection terminals.

Electrical Specifications

Power supply voltage	24VDC (20.4VDC ~ 28.8VDC) (-15% ~ +20%)
Max. rated power consumption	2W, supplied by external power.
Operation/storage	Operation: 0°C~55°C (temperature), 5~95% (humidity), pollution degree 2 Storage: -25°C~70°C (temperature), 5~95% (humidity)
Vibration/shock resistance	International standards: IEC61131-2, IEC 68-2-6 (TEST Fc)/ IEC61131-2 & IEC 68-2-27 (TEST Ea)
Series connection to DVP-PLC MPU	The modules are numbered from 0 to 7 automatically by their distance from MPU. No.0 is the closest to MPU and No.7 is the furthest. Maximum 8 modules are allowed to connect to MPU and will not occupy any digital I/O points.

Functional Specifications

DVP04TC-S	Celsius (°C)	Fahrenheit (°F)
Analog input channel	4 channels per module	
Sensors type	J-type, K-type, R-type, S-type, and T-type thermocouple	
Temperature input range	J-type: -100°C ~ 700°C K-type: -100°C ~ 1,000°C R & S type : -10°C ~ 1,700°C T-type : -100°C ~ 350°C	J-type: -148°F ~ 1,292°F K-type: -148°F ~ 1,832°F R & S type : -14°F ~ 3,092°F T-type : -148°F ~ 662°F
Digital conversion range	J-type: K-1,000 ~ K7,000 K-type: K-1,000 ~ K10,000 R & S type : K-100 ~ K17,000 T-type : K-1,000 ~ K3,500	J-type: K-3,280 ~ K12,920 K-type: K-1,480 ~ K18,320 R & S type : K-140 ~ K30,920 T-type : K-1,480 ~ K6,620
Resolution	16 bits (0.1°C)	16 bits (0.1°F)
Overall accuracy	±0.5% of full scale of 25°C (77°F), ±1% of full scale during 0 ~ 55°C (32 ~ 131°F).	
Response time	200ms × channels	

DVP04TC-S	Celsius (°C)	Fahrenheit (°F)
Isolation method	Isolation between digital and analog circuits. There is isolation between channels. 500VDC between digital circuits and Ground 500VDC between analog circuits and Ground 500VDC between analog circuits and digital circuits 500VDC between 24VDC and Ground	
Digital data format	2's complement of 16-bit	
Average function	Yes (CR#2 ~ CR#5)	
Self diagnostic function	Yes	
Communication mode (RS-485)	Yes (CR#32). RS-485 is disabled when the DVP04TC-S is connected in series with an MPU.	

■ Control Register

CR#	Address	Save		Register content	Description				
#0	H'4096	O	R	Model name	Set up by the system: DVP04TC-S model code=H'8B				
#1	H'4097	O	R/W	Thermocouple type	b15~b12	b11~b9	b8~b6	b5~b3	b2~b0
					Reserved	CH4	CH3	CH2	CH1
					Example: Setting of CH1 1. (b2, b1, b0) set to (0, 0, 0), use J-type. 2. (b2, b1, b0) set to (0, 0, 1), use K-type. 3. (b2, b1, b0) set to (0, 1, 0), use R-type. 4. (b2, b1, b0) set to (0, 1, 1), use S-type. 5. (b2, b1, b0) set to (1, 0, 0), use T-type.				
CR#1: Used to set the working mode of four channels. There are 5 modes (J-type, K-type, R-type, S-type, and T-type) for each channel and can be set individually. For example, If you want to set CH1~CH4 as following: CH1: mode 0 (b2 ~ b0=000), CH2: mode 1 (b5 ~ b3=001), CH3: mode 0 (b8 ~ b6=000) and CH4: mode 1 (b11 ~ b9=001), you should set CR#1 to H'0208. The higher bits (b12 ~ b15) will be reserved and the default setting is H'0000.									
#2	H'4098	O	R/W	CH1 average number	Number piece of readings used for the calculation of "average" temperature on channels CH1 ~ CH4. Setting range: For versions prior to V3.04: K1 ~ K4,095. For versions after V3.05: K1 ~ K20. Default setting is K10.				
#3	H'4099	O	R/W	CH2 average number					
#4	H'409A	O	R/W	CH3 average number					
#5	H'409B	O	R/W	CH4 average number					
CR#2 ~ CR#5: Please be noticed that when PLC sets average times via TO/DTO instructions, please use rising-edge/falling-edge detection instruction (such as LDP and LDF) to get correct average times.									
#6	H'409C	X	R	CH1 average degrees	Average degrees for channels CH1 ~ CH4. (Unit: 0.1°C).				
#7	H'409D	X	R	CH2 average degrees					
#8	H'409E	X	R	CH3 average degrees					
#9	H'409F	X	R	CH4 average degrees					
#10	H'40A2	X	R	CH1 average degrees	Average degrees for channels CH1 ~ CH4. (Unit: 0.1°F).				
#11	H'40A3	X	R	CH2 average degrees					
#12	H'40A4	X	R	CH3 average degrees					
#13	H'40A5	X	R	CH4 average degrees					
#14	H'40A8	X	R	Present temp. of CH1	Present temperature of channels CH1 ~ CH4. (Unit: 0.1°C).				
#15	H'40A9	X	R	Present temp. of CH2					
#16	H'40AA	X	R	Present temp. of CH3					
#17	H'40AB	X	R	Present temp. of CH4					
#19	H'40AE	X	R	Present temp. of CH1	Present temperature of channels CH1 ~ CH2. (Unit: 0.1°F).				
#20	H'40AF	X	R	Present temp. of CH2					

CR#	Address	Save		Register content		Description										
#21	H'40B0	X	R	Present temp. of CH3		Present temperature of channels CH3 ~ CH4. (Unit: 0.1°F).										
#22	H'40B1	X	R	Present temp. of CH4												
#24	H'40AE	O	R	CH1 OFFSET Value		Adjust offset value of channels CH1 ~ CH4. The range is -1,000 ~ +1,000 and default setting is K0. (Unit: 0.1°C).										
#25	H'40AF	O	R	CH2 OFFSET Value												
#26	H'40B0	O	R	CH3 OFFSET Value												
#27	H'40B1	O	R	CH4 OFFSET Value												
#29	H'40B3	X	R/W	PID mode setting		Set H'5678 to enable PID mode, other set values are invalid. Default: H'0000.										
#30	H'40B4	X	R	Error status		Data register stores the error status. Refer to the error code chart for details.										
#31	H'40B5	O	R/W	Communication address setting		RS-485 communication address. Setting range is 1 ~ 254 and default setting is K1.										
#32	H'40B6	O	R/W	Communication baud rate setting		<p>Communication baud rate. For ASCII mode, date format is 7 bits, even, 1 stop bit (7, E, 1), while RTU mode, date format is 8 bits, even, 1 stop bit (8, E, 1).</p> <p>b0: 4,800 bps (bit/sec). b1: 9,600 bps (bit/sec). (default setting) b2: 19,200 bps (bit/sec). b3: 38,400 bps (bit/sec). b4: 57600 bps (bit/sec). b5: 115,200 bps (bit/sec). b6 ~ b13: Reserved. b14: switch between low bit and high bit of CRC code (RTU mode only). b15: RTU mode.</p>										
#33	H'40B7	O	R/W	Reset to default setting		<table border="1"> <tr> <td>b15~b12</td> <td>b11~ b9</td> <td>b8~b6</td> <td>b5~b3</td> <td>b2~b0</td> </tr> <tr> <td>ERR LED</td> <td>CH4</td> <td>CH3</td> <td>CH2</td> <td>CH1</td> </tr> </table> <p>Example: Setting of CH1 1. b0 ~ b1: Reserved. 2. b2: Set to 1 and PLC will be reset to default settings. Definition of ERR LED: b12~b15=1111 (default settings) 1. b12 corresponds to CH1: when b12=1, scale exceeds the range, ERR LED flashes. 2. b13 corresponds to CH2: when b13=1, scale exceeds the range, ERR LED flashes. 3. b14 corresponds to CH3: when b14=1, scale exceeds the range, ERR LED flashes. 4. b15 corresponds to CH4: when b15=1, scale exceeds the range, ERR LED flashes.</p>	b15~b12	b11~ b9	b8~b6	b5~b3	b2~b0	ERR LED	CH4	CH3	CH2	CH1
b15~b12	b11~ b9	b8~b6	b5~b3	b2~b0												
ERR LED	CH4	CH3	CH2	CH1												
#34	H'40B8	O	R	Software version		Display the software version in hexadecimal. Example: H'010A = version 1.0A										
#35 ~ #48				System used												
<p>Symbols:</p> <p>O: means latched. X: means not latched. (Support when using RS-485 communication, not support when connecting with MPU) R: able to read data by using FROM instruction or RS-485. W: able to write data by using TO instruction or RS-485.</p>																

1. Function code: 03'H - read data from register. 06'H - write one word to register. 10'H - write multiple words to registers.
2. CR#30 is the error code register. Refer to the chart below:

Error description	Content	b15 ~ b8	b7	b6	b5	b4	b3	b2	b1	b0
Power source abnormal	K1 (H'1)	Reserved	0	0	0	0	0	0	0	1
Wiring to empty external contact	K2 (H'2)		0	0	0	0	0	0	1	0
Setting mode error	K4 (H'4)		0	0	0	0	0	1	0	0
Offset/Gain error	K8 (H'8)		0	0	0	0	1	0	0	0
Hardware malfunction	K16 (H'10)		0	0	0	1	0	0	0	0
Digital range error	K32 (H'20)		0	0	1	0	0	0	0	0
Average times setting error	K64 (H'40)		0	1	0	0	0	0	0	0
Instruction error	K128 (H'80)		1	0	0	0	0	0	0	0

Note: Each error code will have corresponding bit (b0 ~ b7). Two or more errors may happen at the same time. 0 means normal and 1 means having error.

3. When CR#29 is set to H'5678, CR#0 ~ CR#34 can be used for PID settings in DVP04TC-S V3.08 and versions above.

PID Mode Content Description			
CR#0	Model name	CR#6	CH1 average degrees (°C)
CR#1	Thermocouple type	CR#7	CH2 average degrees (°C)
CR#2	PID Output % at CH1	CR#8	CH3 average degrees (°C)
CR#3	PID Output % at CH2	CR#9	CH4 average degrees (°C)
CR#4	PID Output % at CH3	CR#6~CR#9: Unit: 0.1°C	
CR#5	PID Output % at CH4		
CR#2~CR#5: 0~1000; Unit: 0.1%			

PID Mode Content Description			
CR#10	Set temperature at CH1	CR#28	Run/Stop & Auto tuning
CR#11	Set temperature at CH2		Bit0: CH1 PID runs/stops
CR#12	Set temperature at CH3		Bit1: CH2 PID runs/stops
CR#13	Set temperature at CH4		Bit2: CH3 PID runs/stops
CR#10~CR#13: Set the PID target value (SV)			Bit3: CH4 PID runs/stops
CR#14	CH1 K _P		0=PID stops; 1=PID runs
CR#15	CH2 K _P		Bit4 : CH1 Auto tuning
CR#16	CH3 K _P		Bit5 : CH2 Auto tuning
CR#17	CH4 K _P		Bit6 : CH3 Auto tuning
CR#19	CH1 K _I		Bit7 : CH4 Auto tuning
CR#20	CH2 K _I	1: The auto tuning function is enabled. After the auto tuning is complete, the value becomes 0.	
CR#21	CH3 K _I	CR#29	Enter PID mode(H'5678) K0: Exit the PID mode
CR#22	CH4 K _I	CR#30	Error Code
CR#24	CH1 K _D	CR#31	CH1 Sampling time
CR#25	CH2 K _D	CR#32	CH2 Sampling time
CR#26	CH3 K _D	CR#33	CH3 Sampling time
CR#27	CH4 K _D	CR#34	CH4 Sampling time
		CR#31~CR#34: 1~30; Unit: 1s	

Note: Users have to enter the PID mode (CR#29= H'5678) before setting other control registers.

感謝您採用台達 DVP 系列產品。DVP04TC-S 溫度量測模組可接受外部 4 點熱電耦溫度感測器，將之轉換成 14 位元之數位信號。透過 DVP-PLC SS/SA/SX/SC/SV 主機程式以指令 FROM/TO 來讀寫模組內之資料，模組內具有多個控制暫存器 (CR)，每個暫存器有 16 bits。電源單元與模組分離，體積小，安裝容易。

- ✦ 請在使用之前，詳細閱讀本使用說明書。實施配線，請務必關閉電源。上電時請勿接觸機體端子或進行維修。輸入電源切斷後，一分鐘之內，請勿觸摸內部電路。
- ✦ 本機為開放型 (OPEN TYPE) 機殼，因此使用者使用本機時，必須將之安裝於具防塵、防潮及免於電擊/衝擊意外之外殼配線箱內。另必須具備保護措施 (如：特殊之工具或鑰匙才可打開) 防止非維護人員操作或意外衝擊本體，造成危險及損壞。
- ✦ 交流輸入電源不可連接於輸入 / 出信號端，否則可能造成嚴重的損壞，因此請在上電之前再次確認電源配線。
- ✦ 本體上之接地端子  務必正確的接地，可提高產品抗雜訊能力。
- ✦ 由測溫體到溫調本體的配線路請用最短距離配線，為了避免雜訊及誘導的影響儘可能將電源線和負載配線分開。
- ✦ DVP04TC-S 溫度量測模組本身體積小，在空間溫度傳導特性易受其他模組熱源影響其量測準確性；建議於安裝配置時盡量配置於最外側，並盡量避免串接於產生熱源較高的數位輸出模組及類比輸出模組。
- ✦ DVP04TC-S 溫度量測模組之輸入誤差會因串接模組熱源所影響，產生的誤差皆在產品規格 ($\pm 1.5^{\circ}\text{C}$) 以內；如需更精密控制請於該操作環境動作 30 分鐘後，輸入標準溫度源進行各通道之誤差值調校 (Offset)。
- ✦ 為了使測定溫度精確值穩定，在室溫操作上電後需要約 20 分鐘的預熱時間 (50°C 約需 30 分鐘預熱時間)。

■ 產品外觀尺寸與部位介紹

詳細部位指示圖與外觀尺寸請參閱英文版[Figure1]，單位：mm。

1. 電源、錯誤及運行指示燈	2. 機種型號	3. DIN 軌固定扣
4. 端子	5. 端子配置	6. I/O 模組定位孔
7. 銘牌	8. I/O 模組連接埠	9. I/O 模組固定扣
10. DIN 軌槽 (35mm)	11. RS-485 通訊埠	12. I/O 模組固定槽
13. 電源輸入口	14. I/O 模組連接埠	

■ 輸入 / 輸出端子台配置

請參閱英文版之端子台配置示意圖。

■ 外部配線

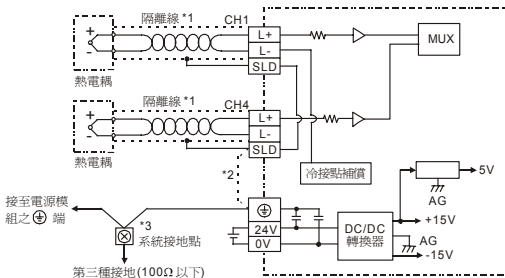

註1：使用於類比輸入的配線應採用 J, K, R, S, T 型熱電耦溫度感測器之連接線或隔離線，且應與其他電源線或可能引起雜訊之接線分開。端子鏢絲扭力為 1.95 kg-cm (1.7 in-lbs)。

註2：如果雜訊過大請將SLD及接地端子連接。

註3：請將電源模組之 ④ 端及DVP04TC-S溫度量測模組之 ④ 端連接到系統接地點，再將系統接點作第三種接地或接到配電箱之機殼上。

注意：空端子請勿配線。只能使用60/75°C的銅導線。

■ 電氣規格

電源電壓	24VDC (20.4VDC ~ 28.8VDC) (-15% ~ +20%)
額定最大消耗功率	2W, 由外部電源供應
操作/儲存環境	1. 操作：0°C ~ 55°C (溫度), 5 ~ 95% (濕度), 污染等級 2 2. 儲存：-25°C ~ 70°C (溫度), 5 ~ 95% (濕度)
耐振動/衝擊	國際標準規範IEC61131-2, IEC 68-2-6 (TEST Fc)/IEC61131-2 & IEC 68-2-27 (TEST Ea)
與DVP-PLC主機串接說明	模組編號以靠近主機之順序自動編號由0到7, 最大可連接8台且不佔用數位I/O點數。

■ 功能規格

DVP04TC-S	攝氏 (°C)	華氏 (°F)
類比訊號輸入通道	4通道 / 台	
適合感應器形式	J-type, K-type, R-type, S-type, T-type 熱電耦	
輸入溫度範圍	J-type : -100°C ~ 700°C K-type : -100°C ~ 1,000°C R & S type : -10°C ~ 1,700°C T-type : -100°C ~ 350°C	J-type : -148°F ~ 1,292°F K-type : -148°F ~ 1,832°F R & S type : -14°F ~ 3,092°F T-type : -148°F ~ 662°F
數位轉換範圍	J-type : K-1,000 ~ K7,000 K-type : K-1,000 ~ K10,000 R & S type : K-100 ~ K17,000 T-type : K-1,000 ~ K3,500	J-type : K-3,280 ~ K12,920 K-type : K-1,480 ~ K18,320 R & S type : K-140 ~ K30,920 T-type : K-1,480 ~ K6,620
解析度	16 bits (0.1°C)	16 bits (0.1°F)
總和精密度	±0.5% 在 (25°C, 77°F) 範圍內滿刻度時。 ±1% 在 (0 ~ 55°C, 32 ~ 131°F) 範圍內滿刻度時。	
響應時間	200ms × 通道數	
隔離方式	數位區與類比區有隔離, 通道間隔離。 數位電路與接地之間：500VDC 類比電路與接地之間：500VDC 類比電路與數位電路之間：500VDC 24VDC與接地之間：500VDC	
數位資料格式	16位元二補數	
平均功能	有 (CR#2 ~ CR#5)	
自我診斷功能	上下極限偵測 / 通道	
通訊模式 (RS-485)	有 (CR#32)。當與PLC主機串接時, RS-485通訊無法使用。	

■ 控制暫存器 (CR)

CR#	參數位址	保持型	暫存器名稱	說明	
#0	H'4096	O	R	機種型號	系統內定, DVP04TC-S機種編碼=H'8B。
#1	H'4097	O	R/W	熱電耦型式	b15~b12 b11~b9 b8~b6 b5~b3 b2~b0
					保留 CH4 CH3 CH2 CH1
以CH1設定來說明：					
1. (b2~b0) 設為(0, 0, 0) 時, 選用J-type。					
2. (b2~b0) 設為(0, 0, 1) 時, 選用K-type。					
3. (b2~b0) 設為(0, 1, 0) 時, 選用R-type。					
4. (b2~b0) 設為(0, 1, 1) 時, 選用S-type。					
5. (b2~b0) 設為(1, 0, 0) 時, 選用T-type。					
CR#1：內容值用來設定溫度量測模組選擇感應器內部四個通道的工作模式, 每個通道各有5種模式, 可獨立設定。例如要將CH1 ~ CH4分別輸入設定為CH1：模式0 (b2 ~ b0=000), CH2：模式1 (b5 ~ b3=001), CH3：模式0 (b8 ~ b6=000), CH4：模式1 (b11 ~ b9=001) 時, 須將CR#1					

CR#	參數位址	保持型	暫存器名稱	說明
設為H'0208。較高位的位元 (b12 ~ b15) 將保留。出廠設定值為H'0000。				
#2	H'4098	O	R/W	CH1平均次數
#3	H'4099	O	R/W	CH2平均次數
#4	H'409A	O	R/W	CH3平均次數
#5	H'409B	O	R/W	CH4平均次數
CR#2 ~ CR#5：注意，當PLC主機利用TO/DTO指令寫入的平均次數設定時，請使用接點上升下降緣檢出指令(LDP/LDF...)，以免無法求得正確之輸入信號平均值。				
#6	H'409C	X	R	CH1量測攝氏溫度平均值
#7	H'409D	X	R	CH2量測攝氏溫度平均值
#8	H'409E	X	R	CH3量測攝氏溫度平均值
#9	H'409F	X	R	CH4量測攝氏溫度平均值
通道CH1 ~ CH4量測攝氏溫度平均值顯示。單位0.1°C。				
#10	H'40A2	X	R	CH1量測華氏溫度平均值
#11	H'40A3	X	R	CH2量測華氏溫度平均值
#12	H'40A4	X	R	CH3量測華氏溫度平均值
#13	H'40A5	X	R	CH4量測華氏溫度平均值
通道CH1 ~ CH4量測華氏溫度平均值顯示。單位0.1°F。				
#14	H'40A8	X	R	CH1量測攝氏溫度現在值
#15	H'40A9	X	R	CH2量測攝氏溫度現在值
#16	H'40AA	X	R	CH3量測攝氏溫度現在值
#17	H'40AB	X	R	CH4量測攝氏溫度現在值
通道CH1 ~ CH4量測攝氏溫度現在值顯示。單位0.1°C。				
#19	H'40AE	X	R	CH1量測華氏溫度現在值
#20	H'40AF	X	R	CH2量測華氏溫度現在值
#21	H'40B0	X	R	CH3量測華氏溫度現在值
#22	H'40B1	X	R	CH4量測華氏溫度現在值
通道CH1 ~ CH4量測華氏溫度現在值顯示。單位0.1°F。				
#24	H'40AE	O	R	CH1 OFFSET值
#25	H'40AF	O	R	CH2 OFFSET值
#26	H'40B0	O	R	CH3 OFFSET值
#27	H'40B1	O	R	CH4 OFFSET值
通道CH1 ~ CH4提供使用者自行調整的OFFSET。可調範圍：-1,000 ~ +1,000。出廠設定值為K0，單位0.1°C。OFFSET值定義：模組量測溫度-OFFSET值=實際顯示溫度。				
#29	H'40B3	X	R/W	PID模式設定
設定H'5678進入PID模式，其他設定值皆為一般模式。出廠設定值H'0000。				
#30	H'40B4	X	R	錯誤狀態
儲存所有錯誤狀態的資料暫存器，詳細內容請參照錯誤信息表。				
#31	H'40B5	O	R/W	通訊位址設定
設定RS-485通訊位址，設定範圍01 ~ 254。出廠設定值為K1。				
#32	H'40B6	O	R/W	通訊速率 (Baud rate) 設定
包含ASCII/RTU模式，ASCII 模式資料格式固定為7 bits、偶位元、1 stop bit (7, E, 1)，RTU 模式資料格式固定為8 bits、偶位元、1 stop bit (8, E, 1)。通訊速率設定共有六種： b0：4,800 bps (位元/秒) b1：9,600 bps (位元/秒) (出廠設定值) b2：19,200 bps (位元/秒) b3：38,400 bps (位元/秒) b4：57,600 bps (位元/秒) b5：115,200 bps (位元/秒) b6 ~ b13：保留 b14：CRC檢查碼高低位交換 (僅RTU模式有效) b15：ASCII/RTU模式切換				

CR#	參數位址	保持型	暫存器名稱	說明					
				b15~b12	b11~ b9	b8~b6	b5~b3	b2~b0	
#33	H'40B7	O	R/W	恢復出廠設定	ERR燈	CH4	CH3	CH2	CH1
					以CH1設定來說明： 1. b0 ~ b1保留。b2設定為1時，所有設定值將回復原廠設定值。 ERR燈定義：原廠設定值b12 ~ b15 = 1111 1. b12對應CH1，當b12=1時，刻度超過ERR燈閃爍動作。 2. b13對應CH2，當b13=1時，刻度超過ERR燈閃爍動作。 3. b14對應CH3，當b14=1時，刻度超過ERR燈閃爍動作。 4. b15對應CH4，當b15=1時，刻度超過ERR燈閃爍動作。				
#34	H'40B8	O	R	韌體版本	16進制，顯示目前韌體版本，如1.0A則H'010A。				
#35 ~ #48				系統內部使用					
符號定義： O表示為保持型；X表示為非保持型。(利用RS-485通訊控制時支援，連接主機時不支援) R表示為可使用FROM指令讀取資料，或利用RS-485通訊讀取資料。 W表示為可使用TO指令寫入資料，或利用RS-485通訊寫入資料。									

1. 功能碼 (Function)：03'H 讀出暫存器資料。06'H 寫入一個 word 資料至暫存器。10'H 寫入多筆 words 資料至暫存器。
2. CR#30 錯誤狀態表：

錯誤狀態	內容值	b15 ~ b8	b7	b6	b5	b4	b3	b2	b1	b0
電源異常	K1 (H'1)	保留	0	0	0	0	0	0	0	1
接點空接	K2 (H'2)		0	0	0	0	0	0	1	0
模式設定錯誤	K4 (H'4)		0	0	0	0	0	1	0	0
O/G錯誤	K8 (H'8)		0	0	0	0	1	0	0	0
硬體故障	K16 (H'10)		0	0	0	1	0	0	0	0
變換值異常	K32 (H'20)		0	0	1	0	0	0	0	0
平均次數設定錯誤	K64 (H'40)		0	1	0	0	0	0	0	0
指令錯誤	K128 (H'80)		1	0	0	0	0	0	0	0
註：每個錯誤狀態由相對應之位元b0 ~ b7決定，有可能會同時產生兩個以上之錯誤狀態，0代表正常無錯誤，1代表有錯誤狀態產生。										

3. 在 V3.08 以上版本，當 CR#29 設定為 H'5678 時，CR#0 ~ CR#34 可做為 PID 設定使用：

PID模式內容說明			
CR#0	機種型號	CR#6	CH1 攝氏平均溫度
CR#1	熱電耦型式	CR#7	CH2 攝氏平均溫度
CR#2	CH1 PID輸出%	CR#8	CH3 攝氏平均溫度
CR#3	CH2 PID輸出%	CR#9	CH4 攝氏平均溫度
CR#4	CH3 PID輸出%	CR#6~CR#9：單位0.1°C	
CR#5	CH4 PID輸出%		
CR#2~CR#5：範圍：0~1000，單位0.1%			
PID模式內容說明			
CR#10	CH1 溫度設定	CR#28	Run/Stop & Auto tuning
CR#11	CH2 溫度設定		Bit0：CH1 PID Run/Stop

CR#12	CH3 溫度設定		Bit1 : CH2 PID Run/Stop
CR#13	CH4 溫度設定		Bit2 : CH3 PID Run/Stop
CR#10~CR#13 : PID目標值設定(SV)			Bit3: CH4 PID runs/stops
CR#14	CH1 K_p		0=PID Stop , 1=PID Run
CR#15	CH2 K_p		Bit4 : CH1 Auto tuning
CR#16	CH3 K_p		Bit5 : CH2 Auto tuning
CR#17	CH4 K_p		Bit6 : CH3 Auto tuning
CR#19	CH1 K_i		Bit7 : CH4 Auto tuning
CR#20	CH2 K_i		設為1會進入Auto turning功能，完畢時自動改為0。
CR#21	CH3 K_i	CR#29	進入PID模式(H'5678) 寫回K0，退出PID模式
CR#22	CH4 K_i	CR#30	錯誤碼
CR#24	CH1 K_D	CR#31	CH1 取樣時間
CR#25	CH2 K_D	CR#32	CH2 取樣時間
CR#26	CH3 K_D	CR#33	CH3 取樣時間
CR#27	CH4 K_D	CR#34	CH4 取樣時間
		CR#31~CR#34 : 範圍1~30，單位1s	
註：需先進入PID模式 (CR#29寫入H'5678)，再對其它CR做設定。			

感谢您采用台达 DVP 系列产品。DVP04TC-S 温度测量模块可接受外部 4 点热电偶温度传感器，将其转换成 14 位的数字信号。透过 DVP-PLC SS/SA/SX/SC/SV 主机程序以指令 FROM/TO 来读写模块内的数据，模块内具有多个控制寄存器 (CR)，每个寄存器有 16 bits。电源单元与模块分离，体积小，安装容易。

- ✎ 请在使用之前，详细阅读本使用说明书。实施配线，务必关闭电源。上电时请勿接触机体端子或进行维修。输入电源切断后，一分钟之内，请勿触摸内部电路。
- ✎ 本机为开放型 (OPEN TYPE) 机壳，因此使用者使用本机时，必须将其安装于具防尘、防潮及免于电击 / 冲击意外的外壳配线箱内。另必须具备保护措施 (如：特殊的工具或钥匙才可打开) 防止非维护人员操作或意外冲击本体，造成危险及损坏。
- ✎ 交流输入电源不可连接于输入 / 出信号端，否则可能造成严重的损坏，因此请在上电之前再次确认电源配线。
- ✎ 本体上的接地端子 \oplus 务必正确的接地，可提高产品抗干扰能力。
- ✎ 由测温体到温调本体的配线路请用最短距离配线，为了避免干扰及诱导的影响尽可能将电源线和负载配线分开。
- ✎ DVP04TC-S 温度测量模块本身体积小，在空间温度传导特性易受其它模块热源影响其测量准确性；建议于安装配置时尽量配置于最外侧，并尽量避免串接于产生热源较高的数字输出模块及模拟输出模块。
- ✎ DVP04TC-S 温度测量模块之输入误差会因串接模块热源所影响，产生的误差皆在产品规格 ($\pm 1.5^{\circ}\text{C}$) 以内；如需更精密控制请于该操作环境动作 30 分钟后，输入标准温度源进行各通道之误差值调校 (Offset)。
- ✎ 为了使测定温度精确值稳定，在室温操作上电后需要约 20 分钟的预热时间 (50°C 约需 30 分钟预热时间)。

■ 产品外观尺寸与部位介绍

详细部位指示图与外观尺寸请参阅英文版[Figure1]，单位：mm。

1. 电源、错误及运行指示灯	2. 机种型号	3. DIN 轨固定扣
4. 端子	5. 端子配置	6. I/O 模块定位孔
7. 铭牌	8. I/O 模块连接口	9. I/O 模块固定扣
10. DIN 轨槽 (35mm)	11. RS-485 通讯口	12. I/O 模块固定槽
13. 电源输入口	14. I/O 模块连接口	

■ 输入 / 输出端子台配置

请参阅英文版的端子配置示意图。

■ 外部配线

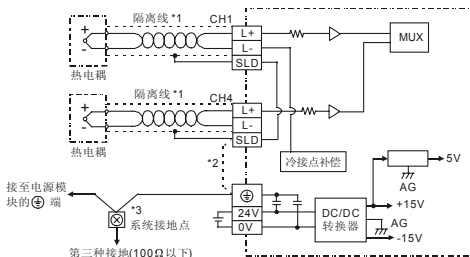

注1：使用于模拟输入的配线应采用 J, K, R, S, T 型热电偶温度传感器的连接线或隔离线，且应与其它电源线或可能引起干扰的接线分开。端子螺丝扭力为 1.95 kg·cm (1.7 in-lbs)

注2：如果干扰过大请将 SLD 及接地端子连接。

注3：请将电源模块的 \oplus 端及 DVP04TC-S 温度测量模块的 \oplus 端连接到系统接地点，再将系统接地点作第三种接地或接到配电箱的机壳上。

注意：空端子请勿配线。只能使用 60/75°C 的铜导线。

■ 电气规格

电源电压	24VDC (20.4VDC ~ 28.8VDC) (-15% ~ +20%)
额定最大消耗功率	2W, 由外部电源供应
操作 / 储存环境	1. 操作: 0°C ~ 55°C (温度), 5 ~ 95% (湿度), 污染等级 2 2. 储存: -25°C ~ 70°C (温度), 5 ~ 95% (湿度)
耐振动 / 冲击	国际标准规范IEC61131-2, IEC 68-2-6 (TEST Fc)/IEC61131-2 & IEC 68-2-27 (TEST Ea)
与DVP-PLC主机串接说明	模块编号以靠近主机的顺序自动编号由0到7, 最大可连接8台且不占用数字I/O点数。

■ 功能规格

DVP04TC-S	摄氏 (°C)	华氏 (°F)
模拟讯号输入通道	4通道/台	
适合感应器形式	J-type, K-type, R-type, S-type, T-type 热电耦	
输入温度范围	J-type: -100°C ~ 700°C K-type: -100°C ~ 1,000°C R & S type: -10°C ~ 1,700°C T-type: -100°C ~ 350°C	J-type: -148°F ~ 1,292°F K-type: -148°F ~ 1,832°F R & S type: -14°F ~ 3,092°F T-type: -148°F ~ 662°F
数字转换范围	J-type: K-1,000 ~ K7,000 K-type: K-1,000 ~ K10,000 R & S type: K-100 ~ K17,000 T-type: K-1,000 ~ K3,500	J-type: K-3,280 ~ K12,920 K-type: K-1,480 ~ K18,320 R & S type: K-140 ~ K30,920 T-type: K-1,480 ~ K6,620
分辨率	16 bits (0.1°C)	16 bits (0.1°F)
总和精密度	±0.5% 在 (25°C, 77°F) 范围内满刻度时。 ±1% 在 (0 ~ 55°C, 32 ~ 131°F) 范围内满刻度时。	
响应时间	200ms × 通道数	
隔离方式	数字电路与模拟电路有隔离, 通道间隔离。 数字电路与接地之间: 500VDC 模拟电路与接地之间: 500VDC 模拟电路与数字电路之间: 500VDC 24VDC与接地之间: 500VDC	
数字数据格式	16位二补码	
平均功能	有 (CR#2 ~ CR#5)	
自我诊断功能	上下极限侦测 / 通道	
通讯模式 (RS-485)	有(CR#32)。当与PLC主机串接时, RS-485通讯无法使用。	

■ 控制寄存器 (CR)

CR#	参数地址	保持型	寄存器名称	说明
#0	H'4096	O R	机种型号	系统内定, DVP04TC-S机种编码=H'8B。
#1	H'4097	O R/W	热电耦型式	b15~b12 b11~b9 b8~b6 b5~b3 b2~b0 保留 CH4 CH3 CH2 CH1
				以CH1设定来说明: 1. (b2~b0) 设为(0, 0, 0) 时, 选用J-type。 2. (b2~b0) 设为(0, 0, 1) 时, 选用K-type。 3. (b2~b0) 设为(0, 1, 0) 时, 选用R-type。 4. (b2~b0) 设为(0, 1, 1) 时, 选用S-type。 5. (b2~b0) 设为(1, 0, 0) 时, 选用T-type。
CR#1: 内容值用来设定温度测量模块选择感应器内部四个通道的工作模式, 每个通道各有5种模式, 可独立设定。例如要将CH1 ~ CH4分别输入设定为CH1: 模式0 (b2 ~ b0=000), CH2: 模式1 (b5 ~ b3=001), CH3: 模式0 (b8 ~ b6=000), CH4: 模式1 (b11 ~ b9=001) 时, 须将CR#1设为H'0208., 较高位的位 (b12 ~ b15) 将保留。出厂默认值为H'0000。				
#2	H'4098	O R/W	CH1平均次数	通道CH1 ~ CH4讯号的平均次数设定:
#3	H'4099	O R/W	CH2平均次数	V3.04以前版本: 可设定范围K1 ~ K4,095。
#4	H'409A	O R/W	CH3平均次数	V3.05以后版本: 可设定范围K1 ~ K20。
#5	H'409B	O R/W	CH4平均次数	出厂设定值为K10。
CR#2 ~ CR#5: 注意, 当PLC主机利用TO/DTO指令写入的平均次数设定时, 请使用接点上升下降缘检出指令 (LDP/LDF...), 以免无法求得正确之输入信号平均值。				

CR#	参数地址	保持型		寄存器名称	说明										
#6	H'409C	X	R	CH1测量摄氏温度平均值	通道CH1 ~ CH4测量摄氏温度平均值显示。单位0.1°C。										
#7	H'409D	X	R	CH2测量摄氏温度平均值											
#8	H'409E	X	R	CH3测量摄氏温度平均值											
#9	H'409F	X	R	CH4测量摄氏温度平均值											
#10	H'40A2	X	R	CH1测量华氏温度平均值	通道CH1 ~ CH4测量华氏温度平均值显示。单位0.1°F。										
#11	H'40A3	X	R	CH2测量华氏温度平均值											
#12	H'40A4	X	R	CH3测量华氏温度平均值											
#13	H'40A5	X	R	CH4测量华氏温度平均值											
#14	H'40A8	X	R	CH1测量摄氏温度现在值	通道CH1 ~ CH4测量摄氏温度现在值显示。单位0.1°C。										
#15	H'40A9	X	R	CH2测量摄氏温度现在值											
#16	H'40AA	X	R	CH3测量摄氏温度现在值											
#17	H'40AB	X	R	CH4测量摄氏温度现在值											
#19	H'40AE	X	R	CH1测量华氏温度现在值	通道CH1 ~ CH4测量华氏温度现在值显示。单位0.1°F。										
#20	H'40AF	X	R	CH2测量华氏温度现在值											
#21	H'40B0	X	R	CH3测量华氏温度现在值											
#22	H'40B1	X	R	CH4测量华氏温度现在值											
#24	H'40AE	O	R	CH1 OFFSET值	通道CH1 ~ CH4提供使用者自行调整的OFFSET。可调范围：-1,000 ~ +1,000。出厂默认值为K0，单位0.1°C。 OFFSET值定义：模块测量温度-OFFSET值=实际显示温度。										
#25	H'40AF	O	R	CH2 OFFSET值											
#26	H'40B0	O	R	CH3 OFFSET值											
#27	H'40B1	O	R	CH4 OFFSET值											
#29	H'40B3	X	R/W	PID模式设定	设定H'5678进入PID模式，其它设定值皆为一般模式。出厂默认值H'0000。										
#30	H'40B4	X	R	错误状态	储存所有错误状态的数据寄存器，详细内容请参照错误信息表。										
#31	H'40B5	O	R/W	通讯地址设定	设定RS-485通讯地址，设定范围01 ~ 254。出厂默认值为K1。										
#32	H'40B6	O	R/W	通讯速率 (Baud rate) 设定	包含ASCII/RTU模式，ASCII模式数据格式固定为7 bits、偶位、1 stop bit (7, E, 1)，RTU模式数据格式固定为8 bits、偶位、1 stop bit (8, E, 1)。 通讯速率设定共有六种： b0: 4,800 bps b1: 9,600 bps (出厂值) b2: 19,200 bps b3: 38,400 bps b4: 57,600 bps b5: 115,200 bps b6 ~ b13: 保留。b14: CRC检查码高低位交换（仅RTU模式有效） b15: ASCII/RTU模式切换										
#33	H'40B7	O	R/W	恢复出厂设定	<table border="1" style="width: 100%; border-collapse: collapse;"> <tr> <td>b15~b12</td> <td>b11~ b9</td> <td>b8~b6</td> <td>b5~b3</td> <td>b2~b0</td> </tr> <tr> <td>ERR灯</td> <td>CH4</td> <td>CH3</td> <td>CH2</td> <td>CH1</td> </tr> </table> <p>以CH1设定来说明： 1. b0 ~ b1保留。b2设定为1时，所有设定值将回复原厂默认值。 ERR灯定义：原厂默认值b12 ~ b15 = 1111 1. b12对应CH1，当b12=1时，刻度超过ERR灯闪烁动作。 2. b13对应CH2，当b13=1时，刻度超过ERR灯闪烁动作。 3. b14对应CH3，当b14=1时，刻度超过</p>	b15~b12	b11~ b9	b8~b6	b5~b3	b2~b0	ERR灯	CH4	CH3	CH2	CH1
b15~b12	b11~ b9	b8~b6	b5~b3	b2~b0											
ERR灯	CH4	CH3	CH2	CH1											

CR#	参数地址	保持型		寄存器名称	说明
					ERR灯闪烁动作。 4. b15对应CH4, 当b15=1时, 刻度超过ERR灯闪烁动作。
#34	H'40B8	O	R	固件版本	16进制, 显示目前固件版本, 如1.0A则H'010A。
#35 ~ #48				系统内部使用	

符号定义:

O表示为保持型; X表示为非保持型。(利用RS-485通讯控制时支持, 连接主机时不支持)

R表示为可使用FROM指令读取数据, 或利用RS-485通讯读取数据。

W表示为可使用TO指令写入数据, 或利用RS-485通讯写入数据。

1. 功能码 (Function): 03'H 读出寄存器数据。06'H 写入一个 word 数据至寄存器。10'H 写入多笔 words 数据至寄存器。
2. CR#30 错误状态表:

错误状态	内容值	b15 ~ b8	b7	b6	b5	b4	b3	b2	b1	b0
电源异常	K1 (H'1)	保留	0	0	0	0	0	0	0	1
接点空接	K2 (H'2)		0	0	0	0	0	0	1	0
模式设定错误	K4 (H'4)		0	0	0	0	0	1	0	0
O/G错误	K8 (H'8)		0	0	0	0	1	0	0	0
硬件故障	K16 (H'10)		0	0	0	1	0	0	0	0
变换值异常	K32 (H'20)		0	0	1	0	0	0	0	0
平均次数设定错误	K64 (H'40)		0	1	0	0	0	0	0	0
指令错误	K128 (H'80)		1	0	0	0	0	0	0	0

注: 每个错误状态由相对应的位b0 ~ b7决定, 有可能会同时产生两个以上的错误状态, 0代表正常无错误, 1代表有错误状态产生。

3. 在 V3.08 以上版本, 当 CR#29 设定为 H'5678 时, CR#0 ~ CR#34 可做为 PID 设定使用:

PID模式内容说明				
CR#0	机种型号	CR#22	CH4 K _i	
CR#1	热电偶型式	CR#24	CH1 K _D	
CR#2	CH1 PID输出%	CR#25	CH2 K _D	
CR#3	CH2 PID输出%	CR#26	CH3 K _D	
CR#4	CH3 PID输出%	CR#27	CH4 K _D	
CR#5	CH4 PID输出%	CR#28	Run/Stop & Auto tuning	
CR#2~CR#5: 范围: 0~1000, 单位0.1%			Bit0: CH1 PID Run/Stop	
CR#6	CH1 摄氏平均温度		Bit1: CH2 PID Run/Stop	
CR#7	CH2 摄氏平均温度		Bit2: CH3 PID Run/Stop	
CR#8	CH3 摄氏平均温度		Bit3: CH4 PID Run/Stop	
CR#9	CH4 摄氏平均温度		0=PID Stop, 1=PID Run	
CR#6~CR#9: 单位0.1°C			Bit4: CH1 Auto tuning	
CR#10	CH1 温度设定		Bit5: CH2 Auto tuning	
CR#11	CH2 温度设定		Bit6: CH3 Auto tuning	
CR#12	CH3 温度设定		Bit7: CH4 Auto tuning	
CR#13	CH4 温度设定		设为1会进入Auto turning功能, 完毕时自动改为0。	
CR#10~CR#13: PID目标值设定(SV)			CR#29	进入PID模式(H'5678)
CR#14	CH1 K _P			写回K0, 退出PID模式
CR#15	CH2 K _P	CR#30	错误码	
CR#16	CH3 K _P	CR#31	CH1 取样时间	
CR#17	CH4 K _P	CR#32	CH2 取样时间	
CR#19	CH1 K _i	CR#33	CH3 取样时间	
CR#20	CH2 K _i	CR#34	CH4 取样时间	
CR#21	CH3 K _i	CR#31~CR#34: 范围1~30, 单位1s		

注: 需先进入PID模式 (CR#29写入H'5678), 再对其它CR做设定。

Delta DVP serisi PLC'leri seçtiğiniz için teşekkürler. DVP04TC-S ünitelerine 4 adet termokupl sıcaklık sensörü bağlanabilir ve bu bağlı sıcaklık sensörlerinden gelen bilgiler 14-bit dijital sinyallere dönüştürülür. Ayrıca DVP PLC CPU'da FROM/TO komutları kullanılarak DVP04TC-S modülünün içine veri yazılabilir veya okunabilir. DVP04TC-S modülünün içinde çok adet 16-bit kontrol register (CR) vardır. Ürünün beslemesi ayrı, küçük boyutlu ve kurulumu kolaydır.

- ✓ Lütfen ürünü kullanmadan önce bu bilgi dökümanını dikkatlice okuyunuz. Bağlantıları yapmadan önce ürünün enerjisini kesiniz. Enerji kesildikten sonra 1 dakika boyunca ürünün iç devrelerine dokunmayınız.
- ✓ Bu ürün AÇIK TİP I/O modülü olduğundan dolayı toz, rutubet, elektrik şoku ve titreşimden uzak kapalı yerlere kurulumu yapılmalıdır. Tehlikeleri ve ürünün zarar görmesini engellemek için yetkili olmayan kişilerin ürüne müdahale etmesini engelleyecek önlemler alınmalıdır. (Ör: Panoya kilit konulması gibi).
- ✓ DVP04TC-S ünitesinin giriş/çıkış terminallerine AC power bağlamayınız, Aksi halde ürün zarar görebilir. Enerji vermeden önce bağlantıları kontrol ediniz.
- ✓ Elektromanyetik gürültüyü engellemek için, DVP04PT-S ürününün topraklamasının doğru olduğuna emin olunuz.
- ✓ DVP04TC-S küçük boyutlu bir ünite ve ısı iletkenliği aynı ortamda bulunan ısı kaynağından etkilenebilir. Bu durum ölçülen sıcaklık değerinin doğruluğunu da etkiler. Onun için DVP04TC-S ünitesini bağlı olduğu analog ve/veya dijital modüllerle birlikte yüksek ısı kaynağının bulunduğu yerlerden uzak yerlere kurulması tavsiye edilir.
- ✓ DVP04TC-S ünitesi girişi yanına takılı modüllerin ısı kaynağından etkilenebilir. Buna bağlı olarak ölçümde özelliklerde belirtilenin üzerinde hata olabilir($\pm 1.5^{\circ}\text{C}$). Eğer daha doğru kontrol yapmak isteniyorsa, sıcaklık kontrolü başladıktan 30 dakika sonra her giriş için offset ayarı yapılması önerilir.
- ✓ Sıcaklık değerini doğru stabilize etmek için, DVP04TC-S ürününe enerji verdikten sonra oda sıcaklığında iken 20 dakika ısıtma süresi beklenmelidir. 50°C çalışmada ise bu süre 30 dakika olmalıdır.

■ Ürün Profili & Ölçüler

Lütfen sayfa 1'de (Şekil 1)'ye bakınız., Birim: mm.

1. Durum indikatör (POWER, RUN ve ERROR)	2. Model adı
3. DIN ray klip	4. I/O terminaller
5. I/O nokta indikatör	6. Montaj delikleri
7. Özellik etiketi	8. I/O modül bağlantı portu
9. I/O modül klip	10. DIN ray (35mm)
11. RS-485 haberleşme portu	12. I/O modül klip
13. DC power girişi	14. I/O modül bağlantı portu

■ I/O Terminal Yerleşimi

Lütfen İngilizce versiyonu için sayfa 2 'ye bakınız.

■ Harici Bağlantı

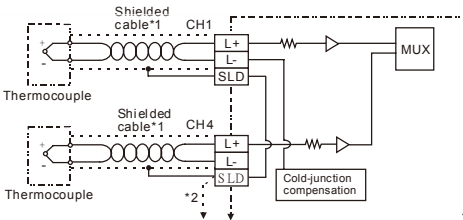

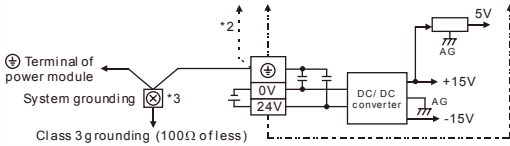

- Not 1:** Ürüne giriş bağlantısı yaparken girişine bağlı termokupl sıcaklık sensörünün orjinal kablосunu kullanınız. PLC terminal vidalarını 1.95 kg-cm (1.7 in-lbs) tork oranında sıkınız.
- Not 2:** Gürültüyü önlemek için SLD terminalini topraklayınız.
- Not 3:** Güç kaynağı modülü ⊕ terminalinden ve DVP04TC-S modülü toprak terminalinden ⊕ topraklanmalıdır.
- Uyarı:** No Connection (NC) terminallerine bağlantı yapmayınız.

■ Elektriksel Özellikler

Power supply voltajı	24VDC (20.4VDC ~ 28.8VDC) (-15% ~ +20%)
Max. güç tüketim oranı	2W, harici beslemeden beslenir.
Çalışma/saklama	Çalışma: 0°C~55°C (sıcaklık), 5~95% (rutubet), kirlenme derecesi 2 Saklama: -25°C~70°C (sıcaklık), 5~95% (rutubet)
Titreşim/şok direnci	Uluslararası standartlar: IEC61131-2, IEC 68-2-6 (TEST Fc)/ IEC61131-2 & IEC 68-2-27 (TEST Ea)
DVP-PLC MPU'ya seri bağlantı	Modül CPU'ya bağlandığında uzaklığına göre sırasıyla otomatik olarak 0 – 7 arası numaralandırılır. En yakın modülün numarası "0" ve en uzaktaki modülün numarası "7" dir. Maksimum 8 adet özel modül bağlanabilir ve digital I/O işgal etmezler.

■ Fonksiyonel Özellikler

DVP04TC-S	Celsius (°C)	Fahrenheit (°F)
Analog giriş kanalı	Herbir modül için 4 kanal	
Sensor tipi	J-tipi, K-tipi, R-tipi, S-tipi, ve T-tipi termokupl	
Sıcaklık giriş aralığı	J-tipi: -100°C ~ 700°C K-tipi: -100°C ~ 1,000°C	J-tipi: -148°F ~ 1,292°F K-tipi: -148°F ~ 1,832°F
Sıcaklık giriş aralığı	R & S tipi : -10°C ~ 1,700°C T-tipi : -100°C ~ 350°C	R & S tipi : -14°F ~ 3,092°F T-tipi : -148°F ~ 662°F
Digital dönüşüm aralığı	J-tipi: K-1,000 ~ K7,000 K-tipi: K-1,000 ~ K10,000 R & S tipi : K-100 ~ K17,000 T-tipi : K-1,000 ~ K3,500	J-tipi: K-3,280 ~ K12,920 K-tipi: K-1,480 ~ K18,320 R & S tipi : K-140 ~ K30,920 T-tipi : K-1,480 ~ K6,620
Çözünürlük	16 bit (0.1°C)	16 bit (0.1°F)
Genel doğruluk	±0.5% tam skala 25°C (77°F), ±1% tam skala 0 ~ 55°C (32 ~ 131°F).	
Cevap zamanı	200ms × kanal	
İzolasyon metodu	Digital ve analog devreler arasında izolasyon mevcut. Kanallar arası izolasyon yok. 500VDC Dijital devreler ve Toprak (Ground) arasında 500VDC Analog devreler ve Toprak (Ground) arasında 500VDC Analog devreler ve Dijital devreler arasında 500VDC 24VDC ve Toprak (Ground) arasında	
Digital data formatı	16-bit, 2'nin komplementi	
Ortalama fonksiyonu	Mevcut (CR#2 ~ CR#5)	
Self diagnostic fonksiyonu	Mevcut	

DVP04TC-S	Celsius (°C)	Fahrenheit (°F)
Haberleşme modu (RS-485)	Mevcut (CR#32). DVP04TC-S ünitesi CPU'nun yanına takıldığı zaman RS-485 pasif olur.	

■ Kontrol Register

CR#	Adres	Kayıt		Register içeriği	Açıklama				
#0	H'4096	O	R	Model adı	Sistem tarafından ayarlanır: DVP04TC-S model kodu=H'8B				
#1	H'4097	O	R/W	Termokupl tipi	b15~b12	b11~b9	b8~b6	b5~b3	b2~b0
					Reserve	CH4	CH3	CH2	CH1
<p>Örnek: CH1 ayarı</p> <ol style="list-style-type: none"> (b2, b1, b0) değeri (0, 0, 0), ise J- tipi. (b2, b1, b0) değeri (0, 0, 1), ise K- tipi. (b2, b1, b0) değeri (0, 1, 0), ise R- tipi. (b2, b1, b0) değeri (0, 1, 1), ise S- tipi. (b2, b1, b0) değeri (1, 0, 0), ise T- tipi. 									
<p>CR#1: Dört kanallı çalışma modunu ayarlamak için kullanılır. Her bir kanal için ayrı ayrı ayarlanabilen 5 tane mod vardır. (J-tipi, K-tipi, R-tipi, S-tipi, ve T-tipi). Örneğin, CH1~CH4 kanallarını ayarlamak istiyorsak: CH1: mod 0 (b2 ~ b0=000), CH2: mod 1 (b5 ~ b3=001), CH3: mod 0 (b8 ~ b6=000) ve CH4: mod 1 (b11 ~ b9=001) ayarlamak için, CR#1 register değeri H'0208 ayarlanmalıdır. Yüksek değerli bitler (b12 ~ b15) reserve olup fabrika değeri = H'0000'.</p>									
#2	H'4098	O	R/W	CH1 ortalama adeti	<p>CH1 ~ CH4 kanallarındaki "ortalama" sıcaklık değerini hesaplamak için okuma sayıdır. Ayar aralığı: V3.04 ve öncesi: K1 ~ K4,095. V3.05 ve sonrası: K1 ~ K20. Default ayarı K10.</p>				
#3	H'4099	O	R/W	CH2 ortalama adeti					
#4	H'409A	O	R/W	CH3 ortalama adeti					
#5	H'409B	O	R/W	CH4 ortalama adeti					
<p>CR#2 ~ CR#5: PLC ortalama adetleri TO/DTO komutlarını kullanarak ayarlar, doğru ortalama adetleri ayarlamak için yükselen kenar / düşen kenar kontakları (LDP ve LDF gibi) kullanılması önerilir..</p>									
#6	H'409C	X	R	CH1 ortalama sıcaklık	<p>CH1 ~ CH4 ortalama sıcaklık değeri. (Birim: 0.1°C).</p>				
#7	H'409D	X	R	CH2 ortalama sıcaklık					
#8	H'409E	X	R	CH3 ortalama sıcaklık					
#9	H'409F	X	R	CH4 ortalama sıcaklık					
#10	H'40A2	X	R	CH1 ortalama sıcaklık	<p>CH1 ~ CH4 ortalama sıcaklık değeri. (Birim: 0.1°F).</p>				
#11	H'40A3	X	R	CH2 ortalama sıcaklık					
#12	H'40A4	X	R	CH3 ortalama sıcaklık					
#13	H'40A5	X	R	CH4 ortalama sıcaklık					
#14	H'40A8	X	R	CH1 mevcut sıcaklık	<p>CH1 ~ CH4 mevcut sıcaklık değeri. (Birim: 0.1°C).</p>				
#15	H'40A9	X	R	CH2 mevcut sıcaklık					
#16	H'40AA	X	R	CH3 mevcut sıcaklık					
#17	H'40AB	X	R	CH4 mevcut sıcaklık					
#19	H'40AE	X	R	CH1 mevcut sıcaklık	<p>CH1 ~ CH4 mevcut sıcaklık değeri. (Birim: 0.1°F).</p>				
#20	H'40AF	X	R	CH2 mevcut sıcaklık					
#21	H'40B0	X	R	CH3 mevcut sıcaklık					
#22	H'40B1	X	R	CH4 mevcut sıcaklık					
#24	H'40AE	O	R	CH1 OFFSET Değeri					
#25	H'40AF	O	R	CH2 OFFSET Değeri	<p>CH1 ~ CH4 offset değeri ayarlar. Ayar aralığı -1,000 ~ +1,000 ve fabrika değeri K0. (Birim: 0.1°C).</p>				
#26	H'40B0	O	R	CH3 OFFSET Değeri					
#27	H'40B1	O	R	CH4 OFFSET Değeri					
#29	H'40B3	X	R/W	PID mod ayarı					
<p>PID modu aktif etmek için H'5678 ayarlayın. Diğer ayarlar geçersizdir. Default: H'0000.</p>									

CR#	Adres	Kayıt		Register içeriği	Açıklama										
#30	H'40B4	X	R	Hata (Error) durumu	Hata kodu data register içine kaydedilir. Lütfen hata kodu tablosuna bakınız.										
#31	H'40B5	O	R/W	Haberleşme adresi ayarı	RS-485 haberleşme adresi. Ayar aralığı 1 ~ 254 ve fabrika ayarı K1.										
#32	H'40B6	O	R/W	Haberleşme hızı (baud rate) ayarı	Haberleşme baud rate (4,800, 9,600, 19,200, 38,400, 57,600 ve 115,200bps). ASCII mod için, data formatı 7 bit, even, 1 stop bit (7, E, 1), RTU modda iken, data formatı 8 bit, even, 1 stop bit (8, E, 1). b0: 4,800 bps (bit/sn). b1: 9,600 bps (bit/sn). (default ayarı) b2: 19,200 bps (bit/sn). b3: 38,400 bps (bit/sn). b4: 57600 bps (bit/sn). b5: 115,200 bps (bit/sn). b6 ~ b13: Reserve. b14: CRC code düşük bit ve yüksek bit arasında anahtarlama (Sadece RTU modda). b15: RTU mod.										
#33	H'40B7	O	R/W	Fabrika Ayarlarına Reset	<table border="1"> <thead> <tr> <th>b15~b12</th> <th>b1~b9</th> <th>b8~b6</th> <th>b5~b3</th> <th>b2~b0</th> </tr> </thead> <tbody> <tr> <td>ERR LED</td> <td>CH4</td> <td>CH3</td> <td>CH2</td> <td>CH1</td> </tr> </tbody> </table> <p>Örnek: CH1 ayarı 1. b0 ~ b1: Reserve. 2. b2: 1 yapılırsa ve ürün fabrika ayarlarına resetlenir. ERR LED açıklaması: b12~b15=1111 (default ayarlar) 1. b12 CH1 kanalı: b12=1 ise okunan değer sınırı aştı, ERR LED flash yapar. 2. b13 CH2 kanalı: b13=1 ise okunan değer sınırı aştı, ERR LED flash yapar. 3. b14 CH3 kanalı: b14=1 ise okunan değer sınırı aştı, ERR LED flash yapar. 4. b15 CH4 kanalı: b15=1 ise okunan değer sınırı aştı,ERR LED flash yapar.</p>	b15~b12	b1~b9	b8~b6	b5~b3	b2~b0	ERR LED	CH4	CH3	CH2	CH1
b15~b12	b1~b9	b8~b6	b5~b3	b2~b0											
ERR LED	CH4	CH3	CH2	CH1											
#34	H'40B8	O	R	Software versiyon	Yazılım versiyonunu heksadesimal olarak gösterir. Ör: H'010A = versiyon 1.0A										
#35 ~ #48				Sistem kullanır											
Semboller: O: kalıcı. X: kalıcı değil. (RS-485 kullanılırken destekler, CPU'nun yanında iken desteklemez) R: FROM komutu veya RS-485 kullanılarak okunabilen data. W: FROM komutu veya RS-485 kullanılarak yazılabilen data.															

- Fonksiyon kodu: 03'H – registerden data okuma. 06'H – registre 1 word yazma. 10'H – registerlere çoklu word yazma.
- CR#30 hata kodu (error code) register. Aşağıdaki tabloyu inceleyiniz:

Hata açıklaması	İçerik	b15 ~ b8	b7	b6	b5	b4	b3	b2	b1	b0
Power beslemesi anormal	K1 (H'1)	Reserved	0	0	0	0	0	0	0	1
Boş harici kontak bağlantısı	K2 (H'2)		0	0	0	0	0	0	1	0
Ayar modu hatası	K4 (H'4)		0	0	0	0	0	1	0	0
Offset/Gain hatası	K8 (H'8)		0	0	0	0	1	0	0	0
Donanım hatası	K16 (H'10)		0	0	0	1	0	0	0	0
Dijital aralık hatası	K32 (H'20)		0	0	1	0	0	0	0	0
Ortalama adet ayarı hatası	K64 (H'40)		0	1	0	0	0	0	0	0

Hata açıklaması	İçerik	b15 ~ b8	b7	b6	b5	b4	b3	b2	b1	b0
Komut hatası	K128 (H'80)	Reserved	1	0	0	0	0	0	0	0
Not: Her hata kodu bir bite karşılık gelecektir (b0 ~ b7). İki veya daha fazla hata aynı anda meydana gelebilir. "0" normal durumu "1" ise hata olduğunu gösterir..										

3. CR#29 değeri H'5678 ayarlandığı zaman, DVP04TC-S V3.08 ve üzeri versiyonlarda CR#0 ~ CR#34 kontrol registerleri PID ayarları için kullanılabilir.

PID Mod İçeriği Açıklaması			
CR#0	Model adı	CR#6	CH1 ortalama sıcaklık (°C)
CR#1	Termokupl tipi	CR#7	CH2 ortalama sıcaklık (°C)
CR#2	PID çıkış % CH1	CR#8	CH3 ortalama sıcaklık (°C)
CR#3	PID çıkış % CH2	CR#9	CH4 ortalama sıcaklık (°C)
CR#4	PID çıkış % CH3	CR#6~CR#9: Birim: 0.1°C	
CR#5	PID çıkış % CH4		
CR#2~CR#5: 0~1000; Birim: 0.1%			
PID Mod İçeriği Açıklaması			
CR#10	CH1 sıcaklık ayarı	CR#28	Run/Stop & Auto tuning
CR#11	CH2 sıcaklık ayarı		Bit0: CH1 PID run/stop
CR#12	CH3 sıcaklık ayarı		Bit1: CH2 PID run/stop
CR#13	CH4 sıcaklık ayarı		Bit2: CH3 PID run/stop
CR#10~CR#13: PID hedef set değeri (SV)			Bit3: CH4 PID run/stop
CR#14	CH1 K _P		0=PID stop; 1=PID run
CR#15	CH2 K _P		Bit4: CH1 auto tuning
CR#16	CH3 K _P		Bit5: CH2 auto tuning
CR#17	CH4 K _P		Bit6: CH3 auto tuning
CR#19	CH1 K _I		Bit7: CH4 auto tuning
CR#20	CH2 K _I	1: Auto tuning fonksiyonu etkindir. Auto tuning işlemi tamamlandıktan sonra, değer 0 olur.	
CR#21	CH3 K _I	CR#29	PID moda giriş(H'5678) K0: PID modundan çıkış
CR#22	CH4 K _I	CR#30	Hata (Error) Kodu
CR#24	CH1 K _D	CR#31	CH1 Örnekleme zamanı
CR#25	CH2 K _D	CR#32	CH2 Örnekleme zamanı
CR#26	CH3 K _D	CR#33	CH3 Örnekleme zamanı
CR#27	CH4 K _D	CR#34	CH4 Örnekleme zamanı
CR#31~CR#34: 1~30; Birim: 1s			
Not: Diğer kontrol registerlerini ayarlamadan önce PID modunu (CR # 29 = H'5678) aktif etmeniz gerekmektedir.			

TÜRKİYE İTHALATÇI FIRMA

FABRİKA AYGITLARI SİSTEM TEKNOLOJİSİ BİLGİSAYAR YAZILIM VE ELEKTRONİK PAZARLAMA İTHALAT İHRACAT ANONİM ŞİRKETİ

FAST Plaza Küçükbakkalköy Mh. Dereyolu Sk. No:4
ATAŞEHİR / İSTANBUL
T: +[90] 216 574 94 34 F: +[90] 216 574 16 60
E: satis@fastltd.net W: www.fastltd.net

**Üretici Firma
Delta Electronics, Inc.**

Taiwan
31-1 Xingbang Road,
Gushan Industrial Zone,
Taoyuan County 33370,
Taiwan
TEL: 886-3-362-6301
FAX: 886-3-362-7267

China
1688 Jiangxing East Road,
Wujiang Economic Development Zone
Wujiang City, Jiang Su Province,
People's Republic of China (Post code: 215200)
TEL: 86-512-6340-3005
FAX: 86-769-6340-7290